

HiFi SERIE

AMT23CM1.1-R

Special Properties

- Low Crossover Frequency
- Extended Bandwidth

RESISTANCE	NOMINAL 8 OHM
Zo 7.1 OHM • Zmin 6.9 OHM • RE 6.9 OHM	
SENSITIVITY @ 2.83 V	90 dB
FREQUENCY RESPONSE / -6 dB	1300 Hz – 33 kHz
POWER HANDLING	125 W
RESONANCE FREQUENCY/ FS	1700 Hz
RECOMMENDED CROSSOVER / 6 dB	2700 Hz
RECOMMENDED CROSSOVER / 12 dB	2200 Hz
DISPERSION HORIZONTAL / 15 kHz / -6 dB	60°
DIAPHRAGM AREA	1755 mm ²
MAGNET MATERIAL	NEODYMIUM
FACE PLATE	3 mm Anodized Aluminum
TOTAL WEIGHT	440 g

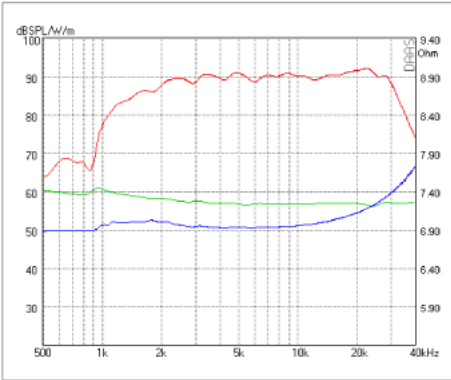

SPL 2.83 V - Phase - Impedance

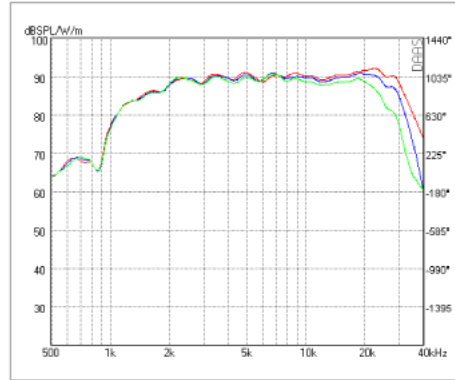

SPL HORIZONTAL 0° - 15° - 30°

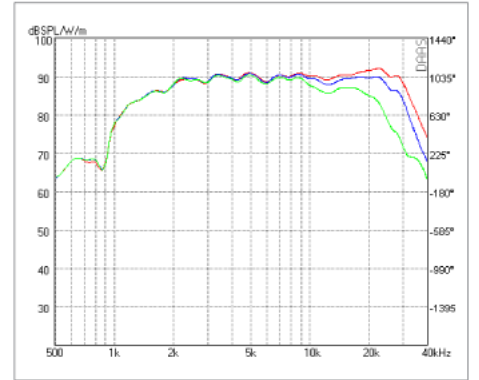

SPL VERTIKAL 0° - 5° - 15°

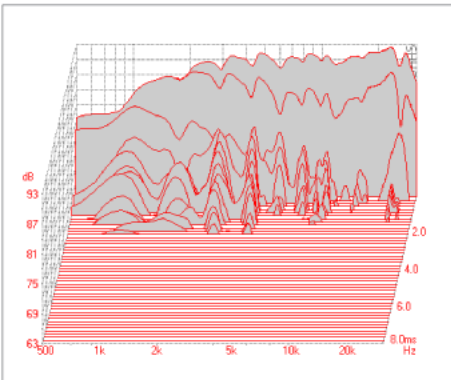

Waterfall

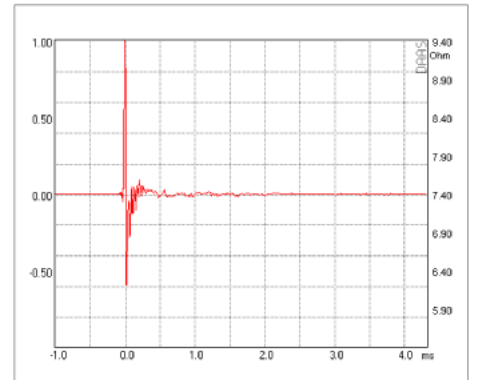
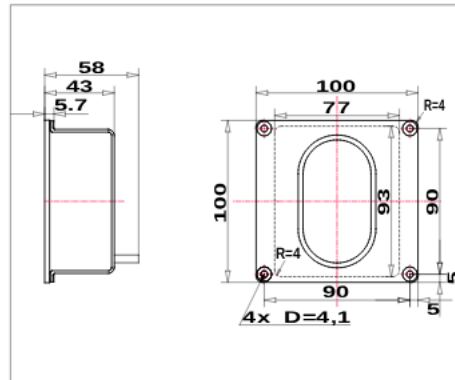

Impulse Response

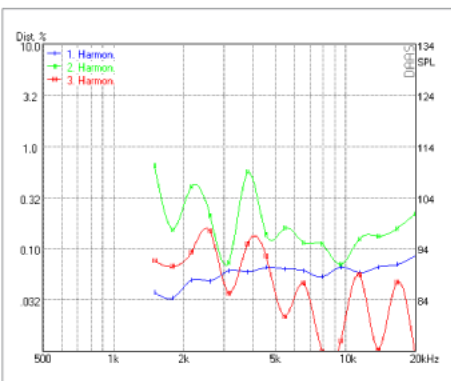

Harmonic Distortion 2.83 V

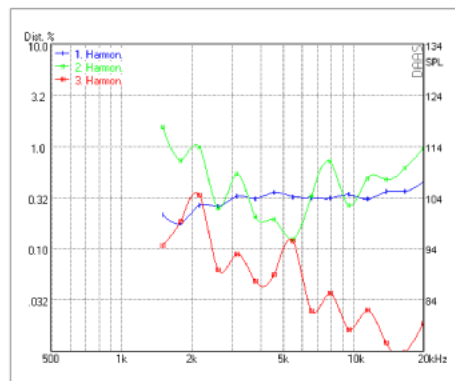

Harmonic Distortion 105 dB

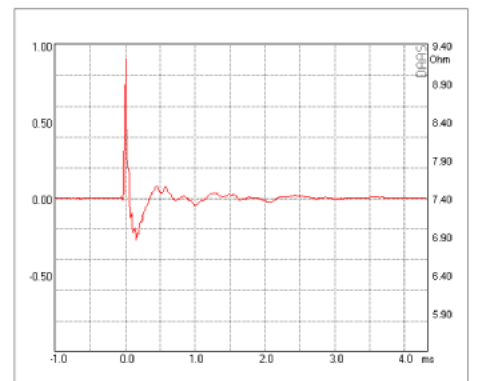

Step Response