







Chair×2

A		2PCS
B		2PCS
S		M6*15 8PCS
W		1PC

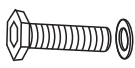

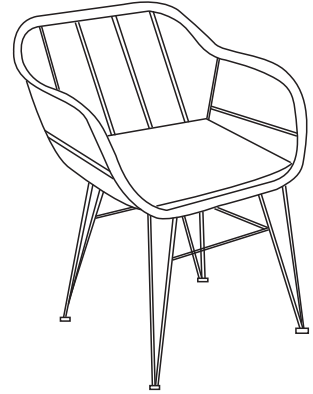
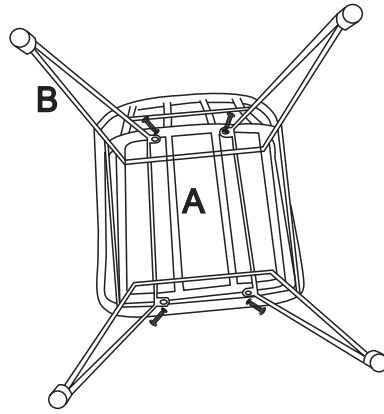
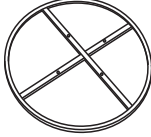
Table

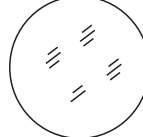
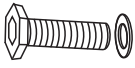
C		1PC
D		1PC
E		1PC
S		M6*15 4PCS

