



Low thermal inertia



Low water content



Versatility



Easy to stock and install



Maximum working pressure



3 international patents



Standard supply	800: from 3 to 10 sections 700: from 3 to 12 sections 600/500/350: from 3 to 14 sections
Colours	RAL 9010 White
Maximum working pressure	16 bar
Test pressure	24 bar

All models **Seven Super B4** are guaranteed **10 years** from installation date on manufacturing faults, provided that the installation has been performed in compliance with the current norms and respecting the instructions relating to the installation, the correct use and the correct maintenance as illustrated on this catalogue.

Model	Heat output				
	ΔT 30	ΔT 40	ΔT 50	ΔT 60	ΔT 70
	W/sect.	W/sect.	W/sect.	W/sect.	W/sect.
350/100	47,2	67,9	89,9	113,1	137,3
500/100	64,1	92,8	123,8	156,5	190,9
600/100	74,0	107,5	143,6	182,0	222,3
700/100	83,1	120,7	161,3	204,5	249,8
800/100	91,1	132,7	177,7	225,6	276,0

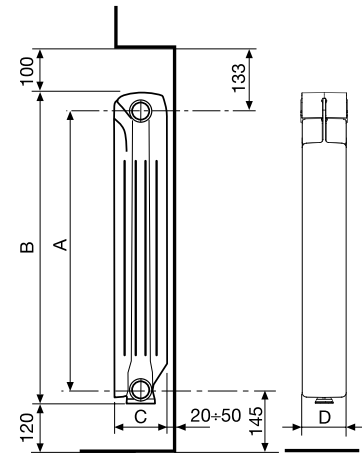







MEASURES EXPRESSED IN MILLIMETRES

Model	Code	Depth	Height	Centre distance	Length	Connection diameters	Water capacity	Exponent	Coefficient
		(C) mm	(B) mm	(A) mm	(D) mm	inches	litres/sect.	n	Km
350/100	V685014	97	407	350	80	G1	0,20	1,2598	0,6506
500/100	V685034	97	558	500	80	G1	0,26	1,2890	0,7991
600/100	V685044	97	658	600	80	G1	0,31	1,2981	0,8950
700/100	V685054	97	758	700	80	G1	0,36	1,2998	0,9986
800/100	V685064	97	858	800	80	G1	0,39	1,3085	1,0635

Maximum working pressure: 1600 kpa (16 bar) Maximum working temperature: 120 °CCharacteristic equation of the model $\Phi = Km \Delta T^n$

The thermal efficiency values shown comply with the European Standard EN 442-1:2014 and are certified by the MRT Lab of the Milan Polytechnic, notified body N°1695.

Item	Description	Code
	A 80 The radiator fixing kit includes: 2 Rh G 1/2" adapters; 2 Lh G 1/2" adapters, galvanized and painted; 4 sealing gaskets; 1 G 1/2" manual bleed valve with seal; 1 G 1/2" blind plug with seal	550103
	A 81 The radiator fixing kit includes: 2 Rh G 1/2" adapters; 2 Lh G 1/2" adapters, galvanized and painted; 4 sealing gaskets; 1 G 1/2" manual bleed valve with seal; 1 G 1/2" blind plug with seal; 3 brackets	550104
	A 2/1 RH/LH G 1" Nipple	510011
	A 10/1 1" Seals for nipples (without asbestos)	530105
	A 11/1 1" Seals for plugs (without asbestos)	530108
	A 20 Kit with two adjustable coated brackets	550037

For other accessories, see from page 57