



# ANDREA



PAGE 138

**PATENTED**

**EUROPEAN  
WARRANTY**

**MATERIAL:**

Vertical collector in painted carbon steel 90x30 mm.  
Horizontal heating elements in painted carbon steel 50x20 mm.

**FIXING KIT:**

Brackets, airvent, hexagonal tool, plugs and screws for mounting suitable for use on compact or hollow brick, user notice.  
The kit is certified from TÜV in compliance with VDI 6036-class 4.

**PACKAGING:**

The radiator is protected by a film in polyethylene and with a carton box.  
User notice included.

**PAINTING PROCESS:**

Painted with ecological epoxy. (Certificate DIN 55900-1,-2).  
Thermal outputs certified in accredited laboratories in compliance with European norm EN442.

**COLOURS:**

Radiator and accessories: standard white colour R01.

## PRODUCT CERTIFICATES



P. max: 5 bar

T. max: 110° C

Available for central heating systems

Connections: n° 2 x 1/2" gas - n° 2 x 1/2" gas

## AWARD



## REVERSIBLE



## ACCESSORIES



**Elegant square manual valve kit painted pure white R01**

Copper connection Ø 12/14/15  
Art. Nr. 5991990310553

Multilayer connection Ø 16  
Art. Nr. 5991990310552



**Elegant square pipe centres 50 mm valve kit painted pure white R01 with thermostatic head - right**

Copper connection Ø 12/14/15  
Art. Nr. 5991990310543

Multilayer connection Ø 16  
Art. Nr. 5991990310542



**Tinta valve pipe centres 50 mm with thermostatic head - right**

Copper connection Ø 12/14/15  
Art. Nr. 5991990311217

Multilayer connection Ø 16  
Art. Nr. 5991990311216



**Elegant with thermostatic head square pure white R01 painted valve kit**

Copper connection Ø 12/14/15  
Art. Nr. 5991990310539

Multilayer connection Ø 16  
Art. Nr. 5991990310538



**Sleeving kit for Pipe Centres 50 mm - valves polished**

Art. Nr. 5103000000057

Accessories and spare parts - see from page 319.

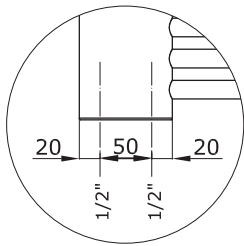
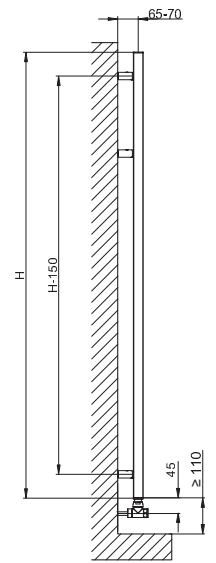
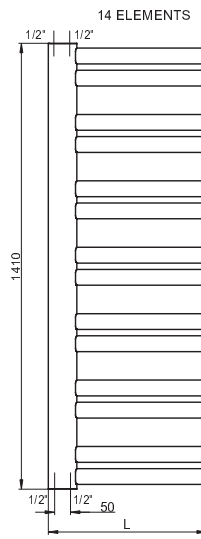
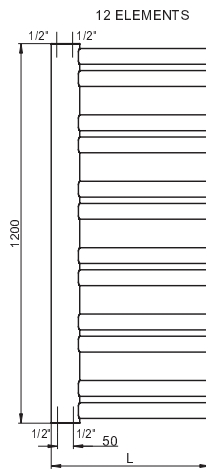
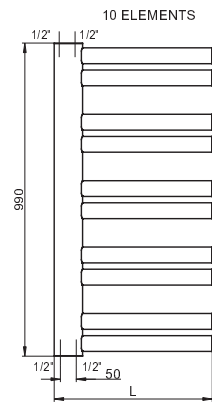
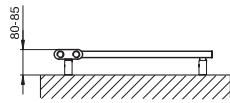
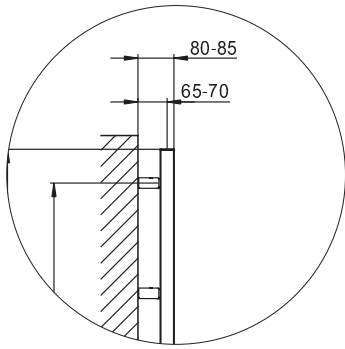

## ANDREA

Art. Nr.	Height	Width	Pipe Centres	Dry Weight	Surface	Water Content	Thermal output Watt		Exponent n
	H [mm]	L [mm]	l [mm]	[Kg]	[m <sup>2</sup> ]	[lt]	$\Delta t = 50^{\circ}\text{C}$	$\Delta t = 30^{\circ}\text{C}$	
3551776100001	<b>990</b>	500	50	10,2	0,8	5,5	390	209	1,2326
3551776100002	<b>1200</b>	500	50	12,2	0,9	6,7	439	239	1,2457
3551776100003	<b>1410</b>	500	50	14,3	1,0	7,8	489	269	1,2499

Art. Nr. are referred to colour WHITE R01 version.

For output at different  $\Delta t$  than  $50^{\circ}\text{C}$ , please refer to the following formula:  $\text{desired output} = \text{output at } \Delta t 50^{\circ}\text{C} \times (\text{desired } \Delta t / 50)^{1,25}$