



Fan Coil Thermostat
Model: FC600



Instructions Manual

Table of contents

1. Introduction	4
1.1. Product Compliance	4
1.2. Safety information	4
1.3. Product Overview	4
2. Operation Manual (Offline Mode)	5
2.1. Principles of Operation	5
2.2. Key Functions	5
2.3. LCD Icon Description	6
2.4. Power Up	8
2.5. Temperature Setpoint	9
2.6. Fan control	10
2.7. Operation Mode Selection	11
2.8. Other Mode Button Functions	14
2.8.1. Setting date and time	15
2.8.2. Setting Schedules	16
2.8.3. Offset Function	19
2.9. Other Functions	19
2.9.1. Frost Protection	19
2.9.2. Key Lock Function	20
2.9.3. Service Filter Reminder	20
2.9.4. Error Codes	20
2.10. STANDBY Mode	21
3. Operation Manual (Online Mode)	22
3.1. Quick Overview	22
3.2. App screen Icon Description	23
3.3. Device name change	24
3.4. Temperature Setpoint	24
3.5. Heat/Cool selection	25
3.6. Work Status	26
3.6.1. Follow Schedule	26
3.6.2. Permanent hold	26
3.6.3. Eco Mode	27
3.6.4. STANDBY Mode	28
3.7. Setting a schedule for the thermostat	29
3.8. Fan Control	31
3.9. Key lock function	31
3.10. Occupancy Sensor	32
3.11. Window Association Function	32
3.12. Identification Function	33
3.13. Pin / Unpin thermostat to the dashboard	33
3.14. Service Settings	34
3.15. Using / Adding OneTouch	35

4. Installer Manual	36
4.1. Box Contents.....	36
4.2. Proper positioning of the thermostat	36
4.3. Idea diagrams	37
4.4. Wiring options.....	40
4.5. Terminals explanation	41
4.6. Wall Mounting.....	43
4.7. Online Mode (with internet connection	45
4.8. Installer Parameters.....	49
4.8.1. In Offline Mode (with no Internet connection)	49
4.8.2. Switching from non-programmable to programmable thermostat.....	49
4.8.3. In Online Mode (via App).....	50
4.9. Full Parameter List.....	50
4.10. Fan and valve operation (V1) including pipe sensor in a 2-pipe system with the use of "d24" and "d25" parameters	56
4.10.1. Fan operation in heating and cooling mode	56
4.10.2. Fan operation in cooling mode	57
4.10.3. Fan operation in heating mode	57
4.11. Switching from offline to online mode.....	58
4.12. Reset Function	60
4.12.1. In Local Mode (without Internet connection)	60
4.12.2. Via App	60
4.13. Cleaning and Maintenance.....	61
4.14. Technical Specification.....	61
4.15. Warranty	62

1. Introduction

1.1. Product Compliance

This product complies with the essential requirements and other relevant provisions of Directives 2014/30/EU, 2014/35/EU, 2014/53/EU and 2011/65/EU. The full text of the EU Declaration of Conformity is available at the following Internet address: www.saluslegal.com

1.2. Safety information

Use in accordance with the regulations. Indoor use only. Keep your equipment completely dry. Disconnect your equipment before cleaning it with a dry towel.

1.3. Product Overview

The Fan Coil thermostat (FC600) is a complex device that can help you control your room temperature and fan speed in a large number of configurations. It can be connected to a 2 or 4 pipe system and can be associated with multiple sensors (occupancy sensors, window sensors, pipe sensors), increasing by that the quality and speed of the temperature management in your home, office, hotel etc. It can be used with a various number of different devices such as trench heaters, central heating boilers, electrical heaters and many more.

The complex structure of the device lets you to set independent schedules on a weekly or daily basis, depending on your preferences and needs. It has multiple work configuration possibilities and can be controlled in both off-line and on-line modes. Besides that, it can work in Eco Mode, ensuring a economy of resources and money.

Feature List

- Control of 2/4 pipe fan coils
- Multiple configurations
- Large LCD
- Maintain room temperature via built in temperature sensor or external room temperature/return air temperature sensor
- Programming options: 5+2 (5 days same+2days same); Individual day every week; All 7 days same
- ECO mode
- Fan speed Hi/Mi/Lo control (automatic or manual)
- Advanced fan control functions (fan start/stop, delay, fan continuously running in manual mode, or depending on heating/cooling demand)
- Auto Frost protection
- Configurable inputs (occupancy sensor or temperature)
- Installer settings
- Span or TPI temperature control algorithm
- Local or remote control by SmartHome App
- Wireless software update by UG600
- Dirty filter notification
- User settings are saved and restored after power break
- Button lock function

The Fan Coil can be used either online or offline. The thermostat can be paired online using UGE600 Universal Gateway (purchased separately), being compatible with the Smart Home App and communicating with other Smart Home devices like the window/door sensors, smart plugs, smart buttons. Also, you can use the Fan Coil without the App. It can operate as a stand alone device.

2. Operation Manual (Offline Mode)

2.1. Principles of Operation



The FC600 is designed for temperature control in rooms equipped with heating and cooling fan coils, water heaters, trench heaters. It can control 2 valves (in 2 pipes the V1 input controls heating and cooling, in 4 pipes V1 controls heating and V2 controls cooling). FC600 can also control the FAN speed in 3 levels: low, medium or high, in order to maintain the room temperature.





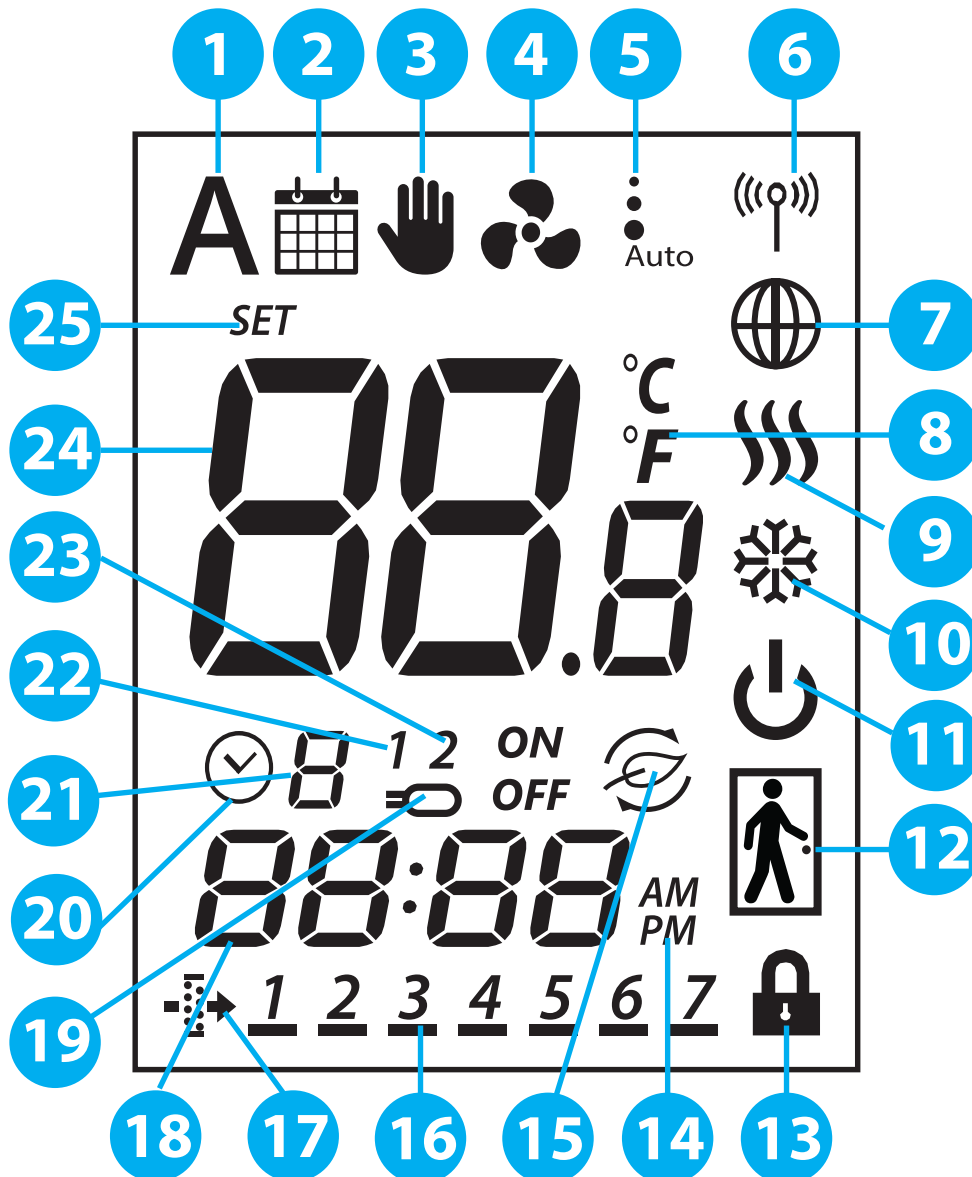

2.2. Key Functions

Key	Function			
	Increase			
	Decrease			
	Fan Speed Low, Medium, High, Auto, Off			
	Mode button*		Short press	Long press (2 sec)
		Digital	Heat/Cool/Eco selection	Offset, Time
		Programmable	Permanent override AUTO Heat/Cool/Eco selection	Programming schedule Offset Time & Date
		* The function of the Mode button depends on the Fan Coil configuration		
	Short press: Confirm function Long press (3 sec): Activate/deactivate STANDBY mode			

2.3. LCD Icon Description



- | | |
|---|-------------------------------------|
| 1. Auto heat/cool selection | 13. Lock function |
| 2. Schedule icon | 14. AM/PM |
| 3. Permanent/temporary override | 15. Eco Mode |
| 4. Fan icon | 16. Day Indicator |
| 5. Fan speed (low, medium, high, Auto, OFF) | 17. Filter icon |
| 6. Wireless communication icon | 18. Current time |
| 7. Glob icon | 19. Sensor indicators |
| 8. Temperature unit | 20. Timer icon |
| 9. Heating Mode ON | 21. Program number |
| 10. Cooling Mode ON | 22. S1/COM Sensor indicators |
| 11. STANDBY mode | 23. S2/COM Sensor indicators |
| 12. Occupancy/vacancy sensor | 24. Room/set point temperature |
| | 25. Set point temperature indicator |

<p>1. Auto heat/cool selection This icon is visible when the thermostat is running in auto heat/cool changeover.</p>	<p>14. AM/PM Appears when you have 12 hours clock format.</p>
<p>2. Schedule icon This icon is visible when the thermostat is programmable and is following the schedule.</p>	<p>15. Eco Mode This icon is visible when the thermostat runs in Eco Mode.</p>
<p>3. Permanent/temporary override This icon is visible always when the thermostat is digital (non-programmable) or when permanent override is enabled. When temporary override is enabled, the icon will appear next to the schedule icon.</p>	<p>16. Current day of the program The current day of the program is underlined.</p>
<p>4. Fan icon This icon is animating in sequence when the fan is running.</p> 	<p>17. Clear filter reminder This icon is visible when the filters have to be replaced.</p>
<p>5. Fan speed (low, medium, high, Auto, OFF) This icon shows fan speed and status.</p> 	<p>18. Current time Time Display.</p>
<p>6. Wireless communication icon This icon appears when the thermostat is connected to the Universal Gateway.</p>	<p>19. Sensor indicators This icon is visible when a sensor is connected to S1/Com or S2/COM terminals.</p>
<p>7. Glob icon This icon is appears when the thermostat is connected to the Universal Gateway and App via Internet.</p>	<p>20. Timer icon Icon appears during programming schedules, indicates start time for a program.</p>
<p>8. Temperature unit °C or F</p>	<p>21. Program number Shows the program number when thermostat follows schedule.</p>
<p>9. Heating Mode ON This icon indicates heating mode. Animating when calling for heat.</p> 	<p>22. S1/COM Sensor indicators Shows a sensor is connected to the S1/COM terminal.</p>
<p>10. Cooling Mode On This icon indicates cooling mode. Animating when calling for cooling.</p> 	<p>23. S1/COM Sensor indicators Shows a sensor is connected to the S2/COM terminal.</p>
<p>11. STANDBY mode This icon indicates the thermostat is in STANDBY Mode or Frost Protection.</p>	<p>24. Room/set point temperature Indicates current room temperature, setpoint temperature etc.</p>
<p>12. Occupancy/vacancy sensor Man in door when presence detected , empty door when not. </p>	<p>25. Set point temperature indicator Icon appears when a new setpoint temperature is being set.</p>
<p>13. Lock function This icon indicates the keys of the device are locked.</p>	

2.4. Power Up

After FC600 has been installed accordingly to your system (for the installation and different systems description please refer to the Installer Section in chapter 4) it will go into STANDBY Mode. To start using your FC600 and adjust room temperature, create schedules and operate the fan you will need to wake it up. Simply press the  button for 3 seconds. The icons on your screen will show up depending on your settings. The time should be 12 AM.

Note: Press any button to activate the LCD first!

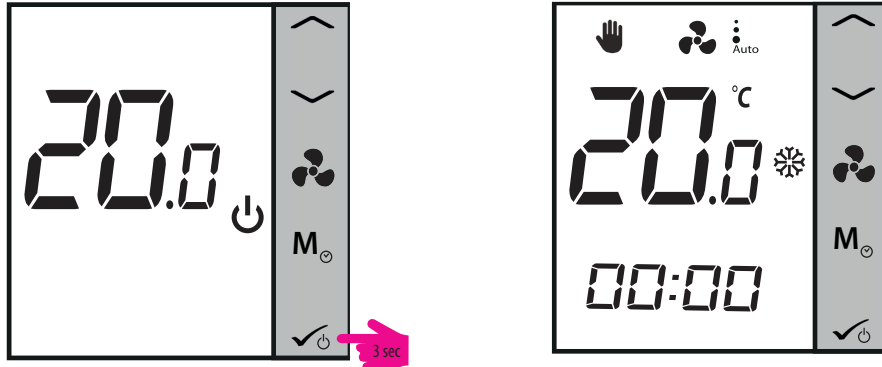



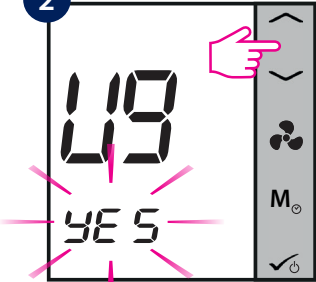

Note: By default, if you are using the thermostat without the Internet, it will be **non-programmable**, meaning that you cannot set programs. The thermostat can be switched to **programmable** mode by changing the d00 parameter from 0 to 1 in Installer Mode. Find more information in the Installer Section.

You can install your thermostat in Local Mode, without using the Universal Gateway UG600 and the App. It will run in Offline Mode. You can always switch to Online mode from Offline. Please see page 49 for details. For first time installation without Internet, please follow the steps below:

- 1** 

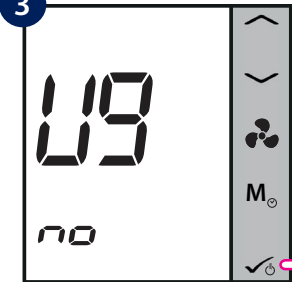
On first activation, FC600 will display software version.
- 2** 

When FC600 goes On, the LCD will show "UG YES" flashing. Please select "NO" using  or , as we are connecting the FC600 without Internet connection.
- 3** 

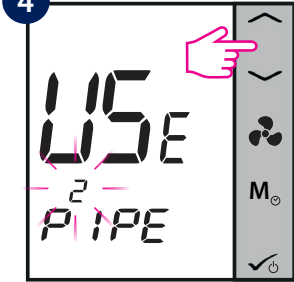
Short press OK .
- 4** 

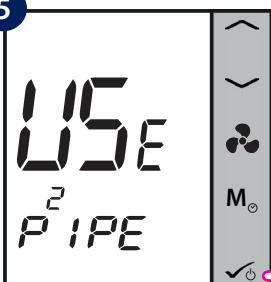
Choose your system type: 2 pipe or 4 pipe.
- 5** 

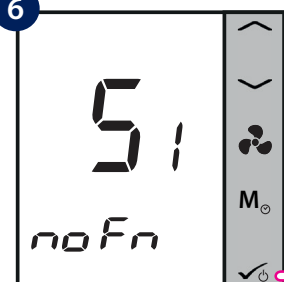
Press OK .
- 6** 

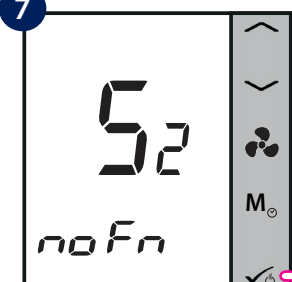
Select what is connected to S1. By default is No function. Please see page 41 for details.
- 7** 

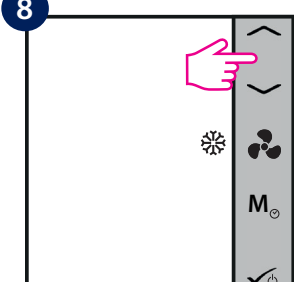
Select an output for S2. the default is No function. Please see page 41 for details.
- 8** 

Please select if you want to use your 2 pipe Fan Coil for Cooling  only...

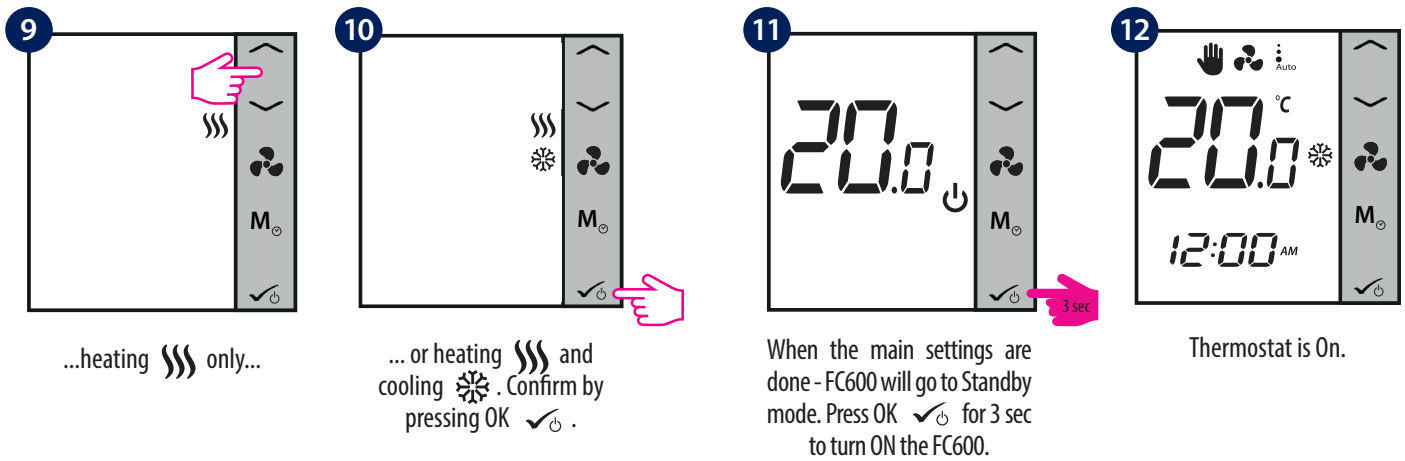

Note: Steps from 8-10 (choosing heating/cooling or both) is available only for the manual heat/cool changeover. If you choose Auto or HCCO at step 6, the thermostat will skip these settings and will enter STANDBY Mode.

2.5. Temperature Setpoint

Setpoint temperature is the temperature you want to set or the temperature set by the program. Under your home display, press or to view the set point temperature. When the program is running, after the short press of the Up/Down arrows, the LCD will show the current program setpoint, with the Set icon.

For non-programmable thermostat

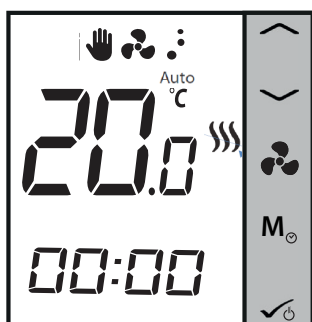
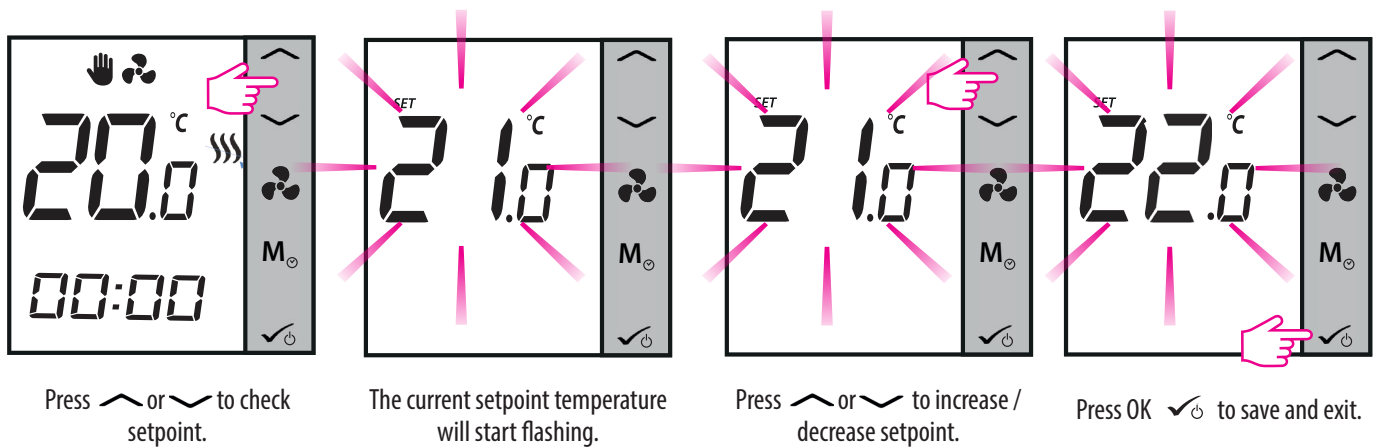

The thermostat will now return to home screen and it will follow new setpoint.

For programmable thermostat

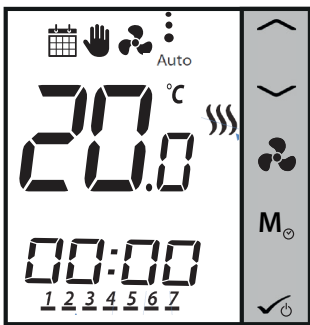
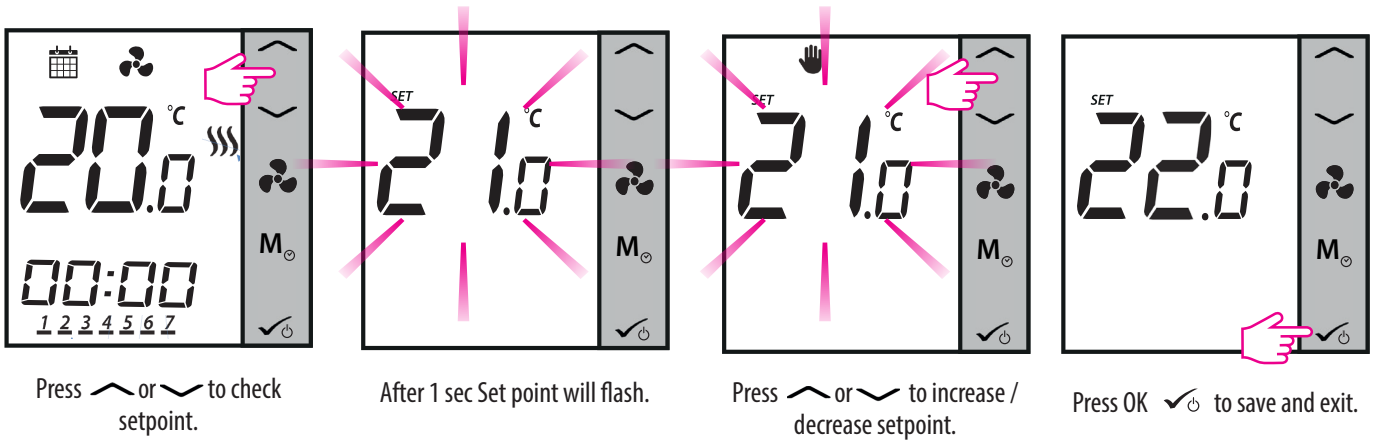

The thermostat will now return to home screen and it will follow new setpoint. It now operates in **Temporary Override** mode. Once the mode is activated, the LCD will display the calendar and hand icons . After entering this mode, the thermostat will use this temporary override setpoint to control room temperature until next Program start time. Then it goes back from Temporary Override to Program mode.

If you press Mode Button during Temporary Override, it will get canceled and the thermostat will enter previous mode.

Note: If you are using the Mode Button, please make sure that thermostat is following the appropriate Heating or Cooling mode (if both are available).

2.6. Fan control

You can use the Fan Button to adjust the fan speed.

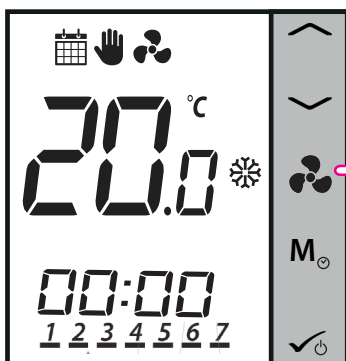

Press to select fan speed

Animation	Meaning
	Fan is not active
	When the fan is running, the fan icon is animated
	Fan speed: Low, Medium, High
Auto /	Fan speed on Auto / Off. When fan is Off all dots and Auto icon disappears

By default, the fan is on only when the Fan Coil calls for heating or cooling.

Note: In program mode, the default fan mode is automatic. The fan mode can be changed to Manual by pressing the Fan Button. The fan will not return to the auto mode until the next program time.

2.7. Operation Mode Selection

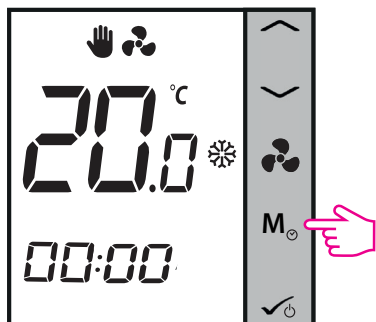

By quick press the Mode Button **M** on your Fan Coil, you can access various modes depending on your settings. Please find a list below with all the possible combinations for the quick press of the Mode Button in both 2 or 4 pipe configuration. Depending on your configuration the thermostat can run in: Cooling mode, Heating Mode, Eco Mode, Schedule Mode, Permanent or Temporary Override, or a combination of these. Find below a description of these modes.



Note: The function of the Mode Button depends on the Fan Coil configuration.

Modes for non-programmable (digital) thermostat

If you have **Manual Heat/Cool selection**, these are the 4 possible combinations you can have by short pressing the Mode Button:

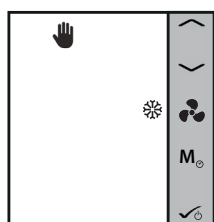

1.



The Hand icon  indicates that the thermostat is in permanent override (manual mode). The snowflake icon  indicates that the thermostat is in Cooling Mode. You can set a temperature lower than the current temperature and the Fan Coil will maintain it until you set a new setpoint.

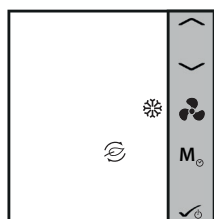

2.



The Leaf icon  indicates that the thermostat is in Eco Mode. The snowflake icon  indicates that the thermostat is in Cooling Mode. When in Eco Mode, the thermostat will use Eco setpoint to control room temperature. You cannot change the temperature in Eco Mode.

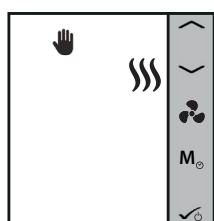

3.



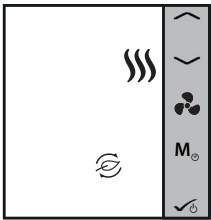

The Hand icon  indicates that the thermostat is in permanent override (manual mode). The heat icon  indicates that the thermostat is in Heating Mode. You can set a temperature higher than the current temperature and the Fan Coil will maintain it until you set a new setpoint.

4.



The Leaf icon  indicates that the thermostat is in Eco Mode. The heat icon  indicates that the thermostat is in Heating Mode. When in Eco Mode, the thermostat will use Eco setpoint to control room temperature. You cannot change the temperature in Eco Mode.

Eco Mode  allows you to temporarily reduce energy consumption by reducing the current setpoint temperature to a certain level, lowering the setpoint temperature when heating or raising it when cooling.

Note: When thermostat operates in Eco Mode, you cannot set a new temperature set point by pressing the  or . After thermostat exits Eco Mode, it returns to the previous set mode.

The default set point temperature is 30°C for cooling mode and 15°C for heating mode. To change that, please refer to settings in Installer Section.

Note: If you have the occupancy sensor, then the Eco Mode will be activated automatically when the set up is complete. This is the default setting. You can choose from either ECO or STANDBY mode when depending on the position of the keycard (in/out).

If your thermostat is set to **Auto Heat/Cool selection**, these are the 2 possible combinations you can have by quick press of the Mode Button:

1.

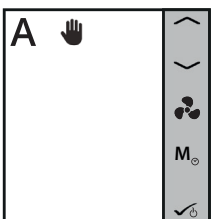

The A icon **A** indicates that the thermostat is running in auto heat/cool changeover mode. The hand icon  shows Permanent Override Mode (manual). You can set a setpoint temperature and the thermostat will follow it. The Heating/Cooling mode will be selected automatically:

- using Heat / Cool changeover sensor connected to S1/COM (available in 2 pipe and 4 pipe application)
- using the pipe sensor connected to S1/COM (available in 2 pipe application only)
- using the "dead zone" (available in 4 pipe application only)

2.

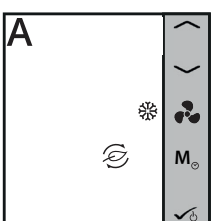



Eco Mode with auto heat/cool changeover. The temperature will be set using Eco temperature setpoint. When in Eco Mode, the thermostat will use Eco set point to control the room temperature. You cannot change the temperature in Eco mode.

Modes for programmable thermostat

If you have **Manual Heat/Cool selection**, these are the 6 possible combinations you can have by quick press of the Mode button:

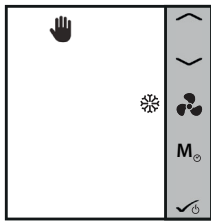

1.



The Hand icon  indicates that the thermostat is in permanent override (manual mode). The snowflake icon  indicates that the thermostat is in Cooling Mode. You can set a temperature lower than the current temperature and the Fan Coil will maintain it until you exit the permanent override or set a new setpoint.

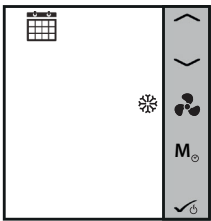

2.



The calendar icon  indicates that the thermostat is following the schedule. The snowflake icon  indicates that it is running in Cooling Mode.

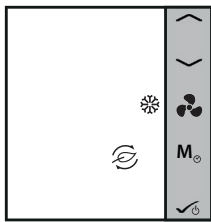

3.

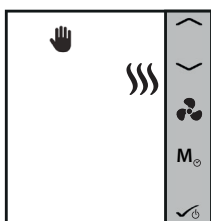

The Leaf icon  indicates that the thermostat is in Eco Mode. The snowflake icon  indicates that the thermostat is in Cooling Mode. When in Eco Mode, the thermostat will use Eco setpoint to control room temperature. You cannot change the temperature in Eco Mode.

4.



The Hand icon  indicates that the thermostat is in permanent override (manual mode). The heat icon  indicates that the thermostat is in Heating Mode. You can set a temperature higher than the current temperature and the Fan Coil will maintain it until you exit the permanent override or set a new setpoint.

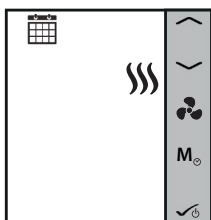

5.

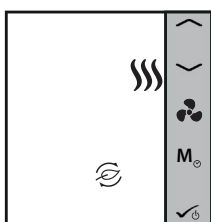

The Calendar icon  indicates that the thermostat is following the schedule. The heat icon  indicates that it is running in Heating Mode.

6.



The Leaf icon  indicates that the thermostat is in Eco Mode. The snowflake icon  indicates that the thermostat is in Heating Mode. When in Eco Mode, the thermostat will use Eco setpoint to control room temperature. You cannot change the temperature in Eco Mode.

If your thermostat is set to **Auto Heat/Cool selection**, these are the 3 possible combinations you can have by short pressing the Mode Button:

1.

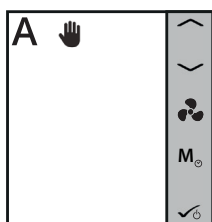

The A icon **A** indicated that the thermostat is running in auto heat/cool changeover mode. The hand icon  shows Permanent Override Mode (manual). You can set a temperature depending on the auto heat/cool changeover setpoint temperature.

2.

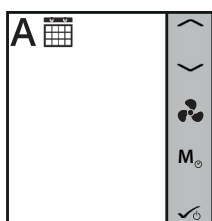

Schedule Auto Mode. The A icon **A** and calendar icon  indicate that the temperature will be set depending on your created schedules and the thermostat will change between the Heating/Cooling modes automatically.

3.

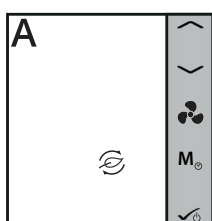

Eco Mode with auto heat/cool changeover. The A icon **A** and leaf icon  indicate that the temperature will be set using Eco temperature setpoint. You cannot change the setpoint in Eco Mode.

2.8. Other Mode Button Functions

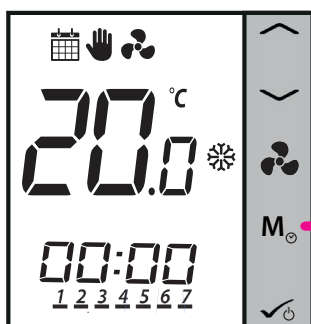

By long pressing the Mode Button **M** on your Fan Coil, you can:

- Set Time and Date
- Create Schedules
- Access Offset Function

Note: Setting the date and creating schedules is available only when the thermostat is programmable (time and offset are available always). As default, the thermostat is configured as digital (non-programmable) thermostat. If you would like to change the thermostat from digital to programmable, you need to change d00 parameter from 0 to 1 (please see page 51).

2.8.1. Setting date and time

Note: If your thermostat is **non-programmable**, it will skip step 2 below and go to step 3! Also, after step 6 it will exit to home screen. You cannot set the date on non-programmable thermostats.

Note: Press any button to turn on the LCD first!

* if programmable only

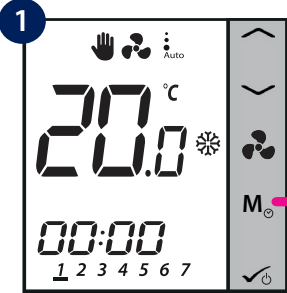

1

Press Mode button **M** for 3 seconds.

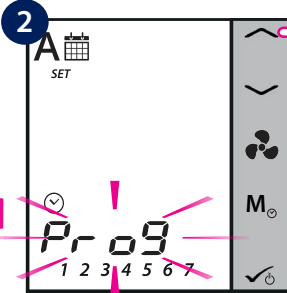

2

Press **▲** one time.*

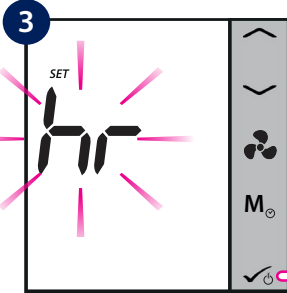

3

Press OK **✓** to enter hour setup.

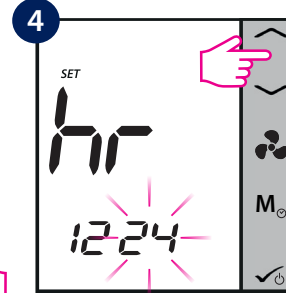

4

Using **▲** or **▼**, select the time format (12/24h). Confirm the selection using **✓**.

* if programmable only

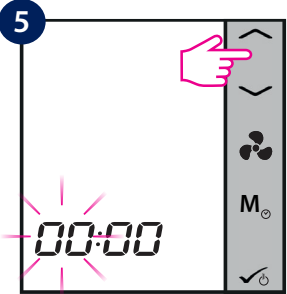

5

Using **▲** or **▼**, select the hour. Confirm the selection using **✓**.

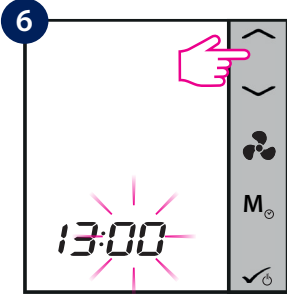

6

Using **▲** or **▼**, select the minutes. Confirm the selection using **✓**.

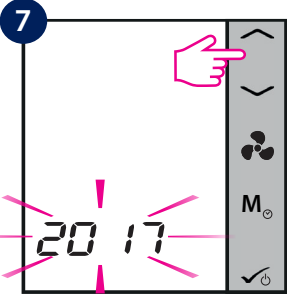

7

Using **▲** or **▼**, select the year. Confirm the selection using **✓**.*

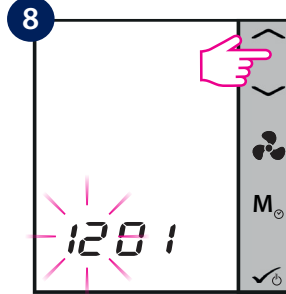

8

Using **▲** or **▼**, select the month. Confirm the selection using **✓**.*

* if programmable only

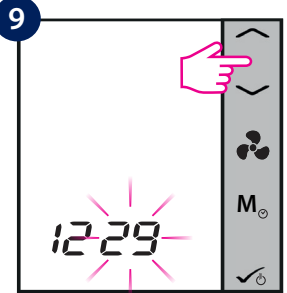

9

Using **▲** or **▼**, select the day. Confirm the selection using **✓**.*

After you have completed time and date setup, you can start setting up your schedules and programs.

2.8.2. Setting Schedules

Make sure that your thermostat is programmable before starting to set schedules (check 4.8.2., page 49). When you start setting the schedules from your thermostat, a default program will be enabled. You can easily modify the initial settings, according to your needs. Please see below a table with the default factory schedules. You can choose from:

- 5+2 (Mon-Fri + Sat-Sun)
- 1-7 (individual programs each day)
- all 7 - the same program for all 7 days of the week

Default Program time and setpoints (for Heating, Cooling and modes and Auto mode) for 2/4 pipe configuration

Program period	Time	Cool mode set point		Heat mode set point	
		Day 1 to 5 (or 1-7 or individual)	Day 6 to 7	Day 1 to 5 (or 1-7 or individual)	Day 6 to 7
1	6:00	24°C	24°C	21°C	21°C
2	8:00	28°C	26°C	18°C	21°C
3	16:00	24°C	24°C	21°C	21°C
4	18:00	28°C	24°C	21°C	21°C
5	22:00	24°C	26°C	18°C	18°C
6	-	-	-	-	-



Press Mode Button **M** for 3 seconds.

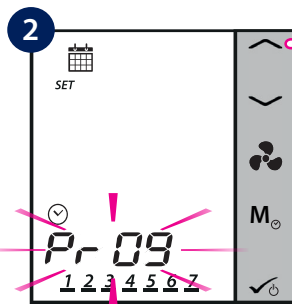

Press UP arrow one time .

Note: The next steps will depend on what configuration you have. If you have manual heat/cool changeover you will need to select which mode you want to set a schedule. If you have Auto heat/cool changeover, the device will skip steps 3-4.

Note: Press any button to activate the LCD first!

Selection of heating mode schedule or cooling mode schedule is available only when the thermostat is set to work in both modes. If the thermostat is set to work in heating mode or cooling mode only then the device will skip steps 3-4, as only one schedule needs to be created. If both modes are available - 2 schedules need to be created (one for heating, another for cooling).

3 Using , select the mode for which you want to set the schedule:

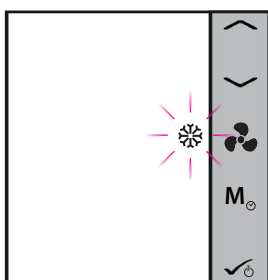

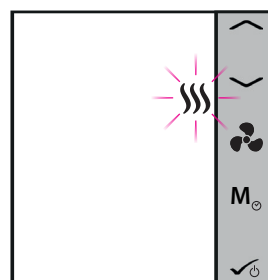

Cooling Mode

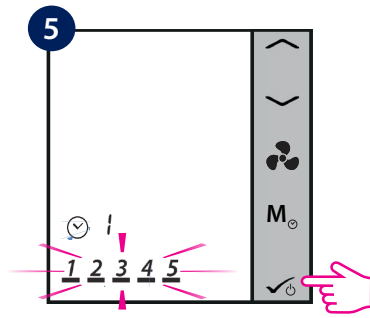

Heating Mode

4 Confirm the selection using .



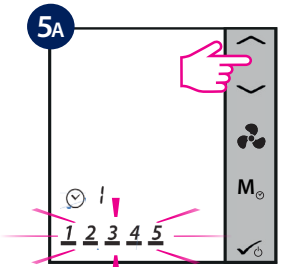

Press OK  to choose Mon-Fri.

Press OK button on this step if you want to set a schedule for Mon-Fri. If you want to choose another type of program, press Up/Down arrow.



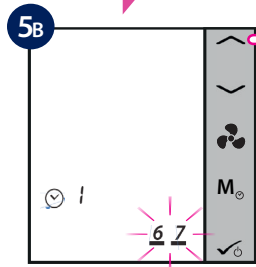

Using  or , choose the schedule mode.

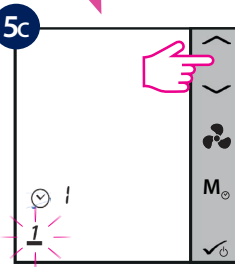

Press one time  to select Sat-Sun only.



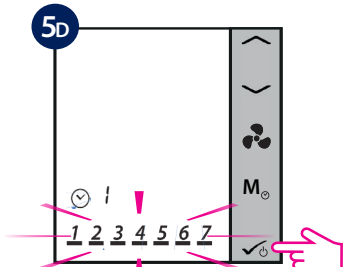

Using  or , select each day individually or 7 times to select the whole week.

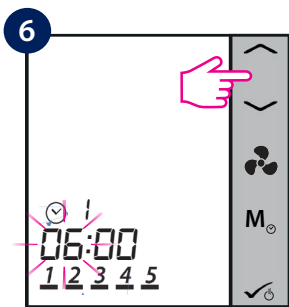

Press OK  to select.



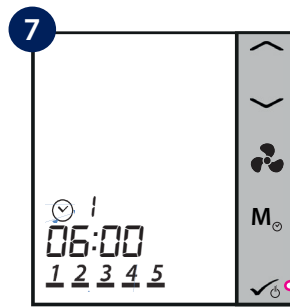

Using  or , set the start time for program 1.

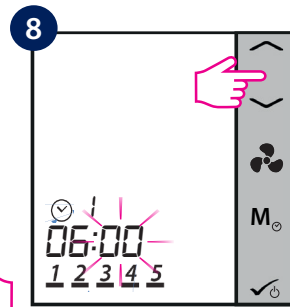

Press OK  to confirm.



Using  or , set the minutes.

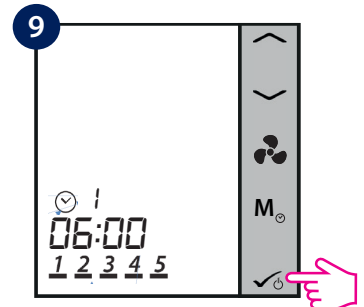

Press OK  to confirm.

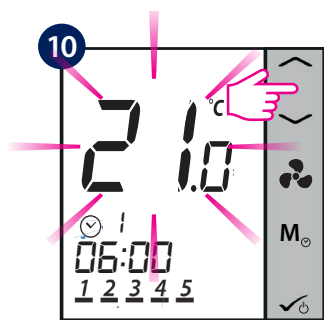

Set a temperature for program 1 using  or .

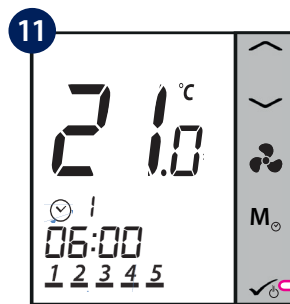



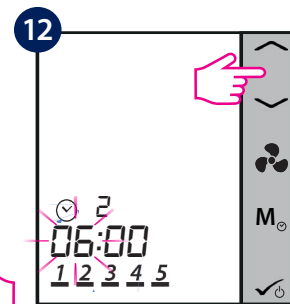

Press OK  to confirm.



Thermostat will go to program 2.

You will have to follow the same steps to set up all six programs, after which the thermostat will go to Sat-Sun and will ask you to set the schedules for those days. You will have to set a start time and a temperature for each of the six programs. If you are programming every day individually, you will have to set the programs from 1-6 for Monday, then Tuesday, Wed, Thu, Fri, Sat and Sun. If you are programming all week the same, you will have to set all the 6 programs just once.

During program setting, few notes:

- During program setting, long press  will save all settings and exit to home display.
- Program schedule time is a 10 minute step.
- If the selected days of week are 1-5+6-7, after you set the schedule for 1-5, the Fan Coil will automatically go to programming 6-7.
- If you are programming whole week the same - after you finish programming schedule for days 1-7, the Fan Coil will exit program setting mode.
- If the selected weekday is Monday, after the program setting is finished, the unit will automatically enter program setting of Tuesday, then Wednesday, Thursday, Friday, Saturday and Sunday, finally exit the program setting mode.
- Long press  or  is only to change fast time and temperature.
- At any time of setting, long press  to return to the home display while saving your settings.
- The selected item will not flash if it is being adjusted. Flashing will resume about 0.5 seconds after key release.
- The unit will return to home display after 30 seconds if no key is pressed, storing the program settings which have been made. The unit will run as per the new program settings.
- The starting time of the next program cannot be equal or earlier than the previous one. For example in the first program starts at 8:00, the next has to start at least 8:10 etc.

2.8.3. Offset Function

Temperature Offset is a feature that lets you adjust the room temperature reading +/- 3.0°C in 0.5 °C steps. This is handy if your thermostat is located in a spot with a slightly different temperature than the overall room temperature. You can access the offset also by pressing the Mode button.

Note: Press any button to activate the LCD first!

1 Press Mode button **M** for 3 seconds.

2 Program menu will be displayed. Press **^**.

3 Clock menu will be displayed. Press **^**.

4 Offset menu will be displayed. Press OK **✓**.

5 Using **^** or **v**, set an offset range.

6

7 Press OK **✓** to confirm and exist to home screen.

8 Home screen with new offset temperature display.

2.9. Other Functions

2.9.1. Frost Protection

Frost Protection is a function that prevents pipes from freezing. Auto Frost Protection is always on and it is set to 5°C. In Frost Protection all outputs are Off. Frost protection is active during the Standby mode as well. If room temperature drops below Frost Protection temperature the heating valve will open and the fan will be turned on at maximum speed.

Long Press **✓** to enter STANDBY / Frost Protection Mode.

Thermostat in STANDBY / Frost Protection Mode.

2.9.2. Key Lock Function

To lock the keys on the thermostat, please press  and  together. LCD shows key lock icon . To unlock the keys, press the same keys together again.

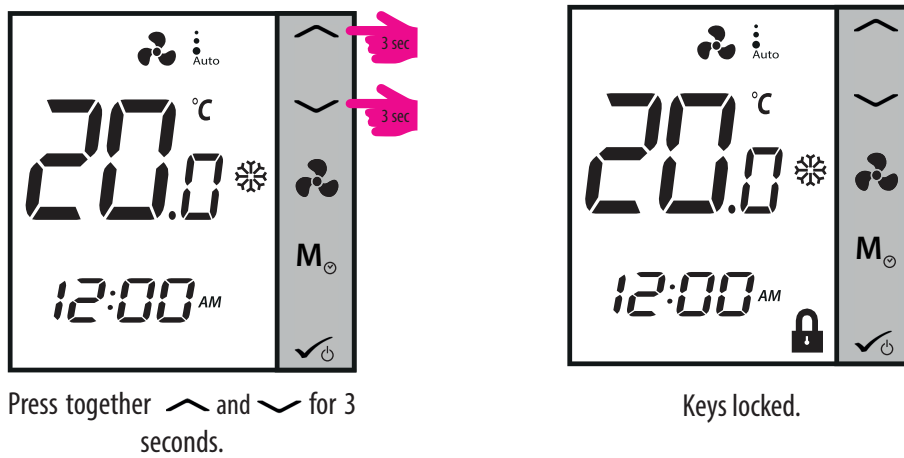

2.9.3. Service Filter Reminder

The 'clean fan filter reminder' function counts the fan operating hours and displays the icon  to remind the user to clean the fan filter as soon as the threshold is reached. This does not impact the thermostat's operation, which continues to run normally.

Long press button  for 5 seconds to cancel filter reminder.

2.9.4. Error Codes

Regardless the mode the Fan Coil is operating in - heating (including Frost Protection) or cooling mode, once the external sensor is disconnected or malfunctioning, the thermostat shows alternately the warning letters for 2 seconds and current temperature for 2 seconds to warn the user the external sensor is disconnected or malfunctioning. At the same time, the LCD backlight will turn on when the warning letters are displayed, then turn off when current temperature is displayed.

Error Code	Description
01	Pipe sensor input is open or pipe sensor is not connected
02	Pipe sensor input short circuit
03	External sensor open or external sensor is not connected
04	External sensor short circuit

When the external sensor is reconnected or fixed, thermostat will return to Normal mode and display the current room temperature.

When Err XX appears, the thermostat will be closed.

2.10. STANDBY Mode

You can enter STANDBY Mode and protection setpoint will be activated. The clock continues running, as well as the temperature sampling. Protection heating and cooling setpoints are activated. To enter STANDBY Mode, long press the OK button ✓ on your thermostat. You can always switch back off STANDBY Mode by long pressing the OK button. All relay outputs immediately change to OFF, regardless of the previous operating mode (heat, cool, auto heat/cool). All your preset settings will be stored. When FC600 works in Standby mode, the Frost Protection is running.

- **Note:** Press any button to activate the LCD first!

Enter STANDBY Mode

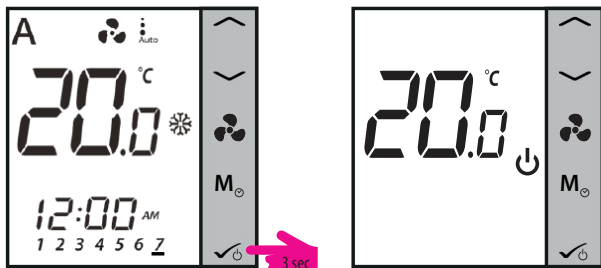

Press OK ✓ for 3 seconds.

STANDBY Mode.

Exit STANDBY Mode

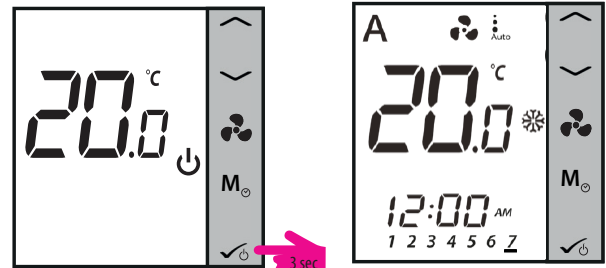

Press OK ✓ for 3 seconds.

Previous Mode.

3. Operation Manual (Online Mode)

3.1. Quick Overview

This section will show how to use your Fan Coil with the Universal Gateway and the Salus Smart Home App. In order to do that, you will be needing a Salus Universal Gateway UG600/UGE600, the Salus Smart Home App and Internet connection. Controlling your thermostat via the App gives you a lot of freedom and the possibility to manage the temperature in your house/office remotely.

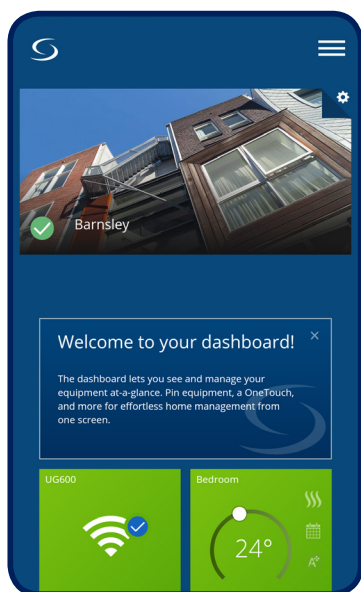

Thermostat tile on the App

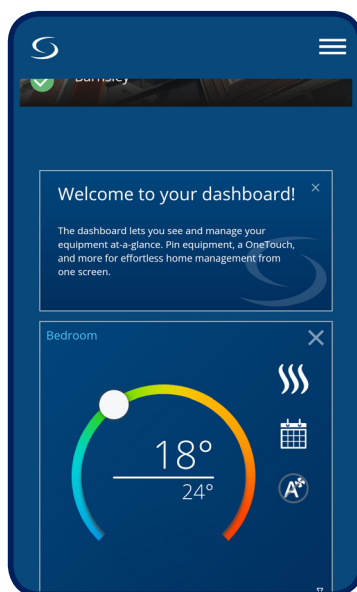

Thermostat tile when tapped

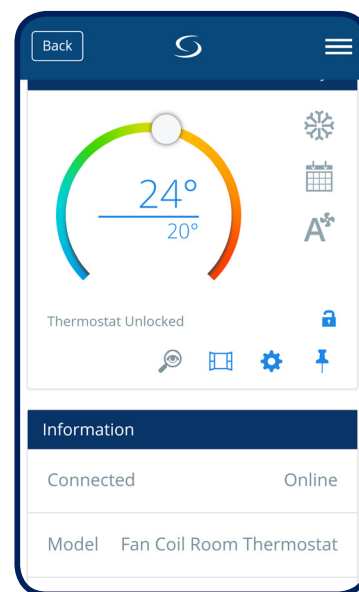

Thermostat interface

The functions available on the App are:

- Device name changing
- Setting room temperature setpoint
- Heat/Cool Selection
- 4 different work statuses: Follow schedule, Permanent Hold, Eco Mode, Off (StandBy Mode)
- Schedule programming
- Fan speed control
- Key Lock Function
- Pin/Unpin thermostat to dashboard
- Window association function
- Identification function
- Service Settings
- Creating/Setting One Touch rules

3.2. App screen Icon Description

Back Button

Home Screen Button

Menu Button

Heat/Cool Icon
If Heat/Cool mode selected, tap for Heating/Cooling

Edit thermostat name

Manually adjust temperature

Set Temperature

Current Temperature

Find your device

Window sensor button

Settings Button

Pin/Unpin thermostat to dashboard

Lock/Unlock thermostat

On/Off/Schedule/Eco/Hold
Tap for submenu

Fan Speed/Off/On
Tap for submenu

🔥	Heating
❄️	Cooling

📅	Follow Schedule
👤	Permanent Hold
🌿	ECO
🔌	Off

A*	Auto
🌀	Fan Speed 3
🌀	Fan Speed 2
🌀	Fan Speed 1
🌀	Fan Off

3.3. Device name change

You can easily change the name of your device at any moment, by tapping the pencil screen on your device name panel.

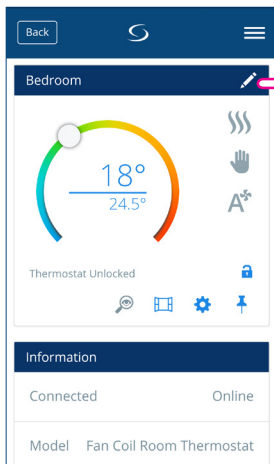

Tap pencil icon .

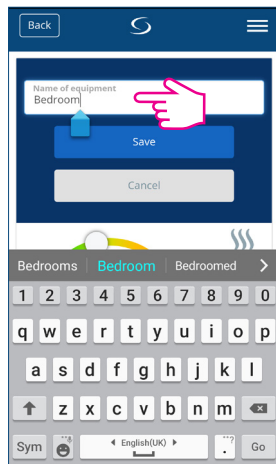

Enter a new name.

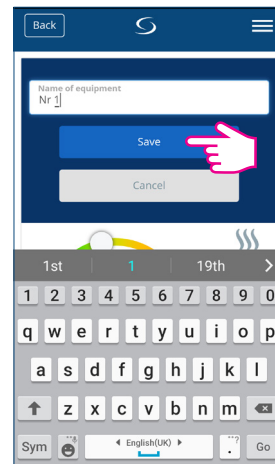

Tap Save.

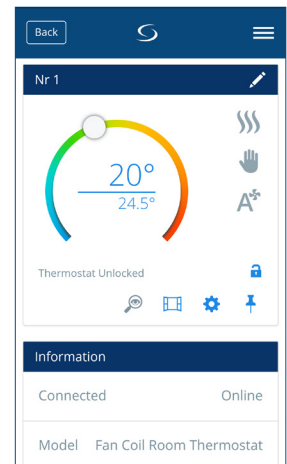

Thermostat renamed.

3.4. Temperature Setpoint

You can change the set point by sliding the cursor to left/right on your App. On your App screen, the setpoint temperature is the number displayed in a larger font.

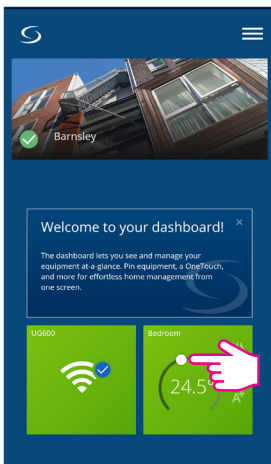

Click on thermostat tile to enter your thermostat.

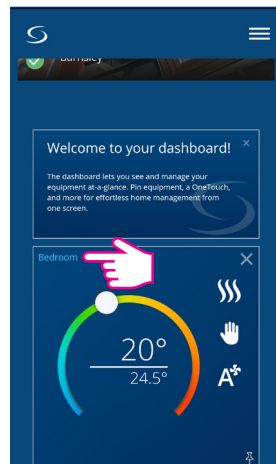

Click on thermostat name to enter main screen.

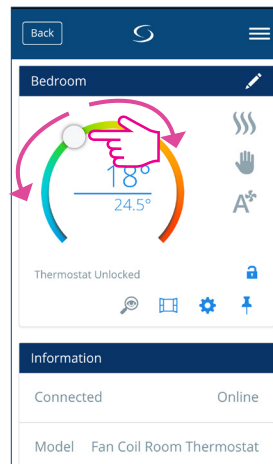

Old setpoint.

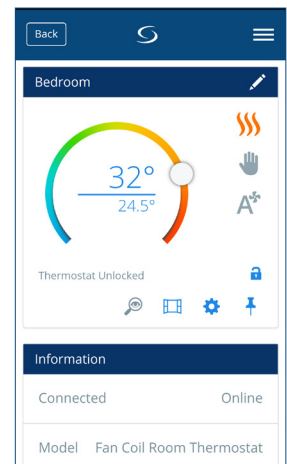

New setpoint.

Sliding the cursor to the left will decrease the temperature, and to the right - will increase. If your thermostat is on permanent hold, it will follow the setpoint temperature until you manually change it again. That is permanent override. If the thermostat is running in schedule mode, but you have manually set another temperature, the new set temperature will run until the next program starts. Make sure that the thermostat operates in heating mode if you want to set a temperature that is higher than the current room temperature and that the thermostat is in cooling mode if you want to set a temperature that is lower than the actual room temperature.

3.5. Heat/Cool selection

The Fan Coil gives you possibility to select between heating or cooling modes via App if the thermostat is set on manual heat/cool change over. To do that, follow these simple steps:

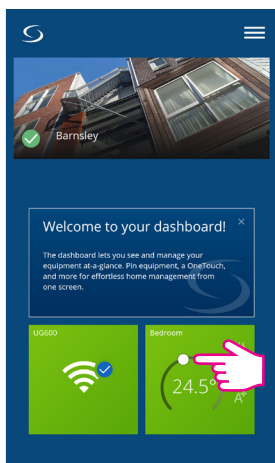

Click on thermostat tile to enter your thermostat.

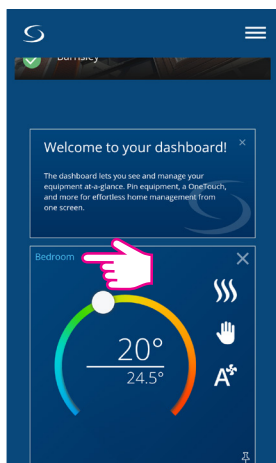

Click on thermostat name to enter main screen.

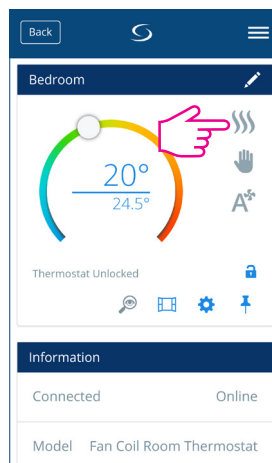



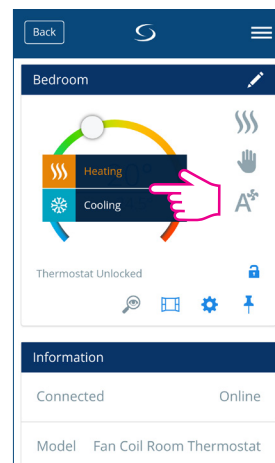

Tap to select mode.



Select Cool/Heat mode.

Note: While in Manual Mode you want to set a temperature that is higher than the current room temperature, you need to choose Heat Mode before changing the Setpoint to the new value. If you want to set a temperature that is lower than the current temperature in the room, you need to choose Cool Mode before changing the Set point to the new value. Otherwise the thermostat will not respond.

App icons for Heat and Cool

Icon	Explanation
 gray	When thermostat is in HEATING mode, but is not calling for HEAT
 orange	When thermostat is in HEATING mode and is calling for HEAT
 gray	When thermostat is in COOLING mode, but is not calling for COOL
 blue	When thermostat is in COOLING mode and is calling for COOL

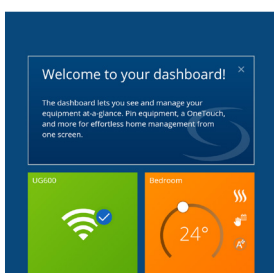

Thermostat tile on the dashboard when thermostat is in Heating Mode and calls for heating.

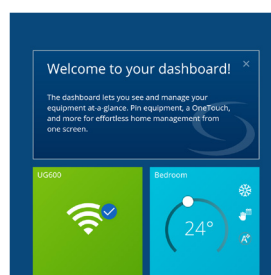

Thermostat tile on the dashboard when thermostat is in Cooling Mode and calls for cooling.

3.6. Work Status

Your Fan Coil can have 4 different work statuses:

1. Follow schedule
2. Permanent Hold
3. Eco Mode
4. Off (STANDBY Mode)

You can choose the status by tapping the work-status icon.

3.6.1. Follow Schedule

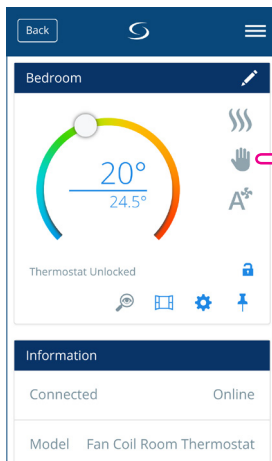

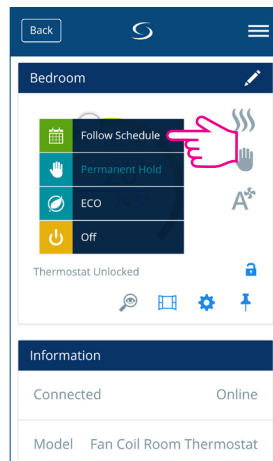

Tap to enter sub-menu.

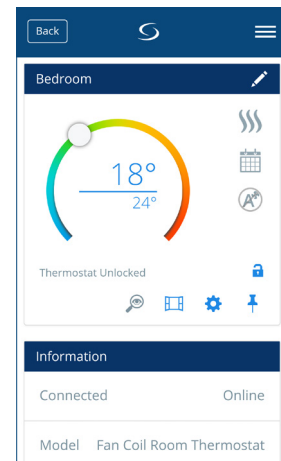

Tap follow schedule .



The thermostat is following the schedule.

Choose this operating mode for the thermostat to follow the programmed schedules. When the thermostat runs in schedule mode, the calendar icon  will be displayed. If the thermostat runs in temporary override mode (the user manually changed the temperature during the program), the hand and the calendar icon  will be displayed together. When in temporary override, the thermostat will return back to following the schedule after a new program set time begins.

3.6.2. Permanent hold

Even if the thermostat is set to following a schedule, the user can change the operating mode to the Permanent Hold one. In Permanent Hold the thermostat will maintain the set point temperature until the user will manually change it to a new value, or select a new operating mode. When the thermostat runs is Permanent Hold, the hand icon  will be displayed on the App screen.

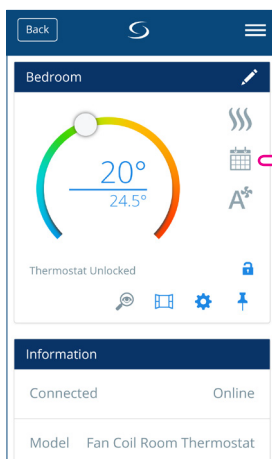

Tap to enter sub-menu.

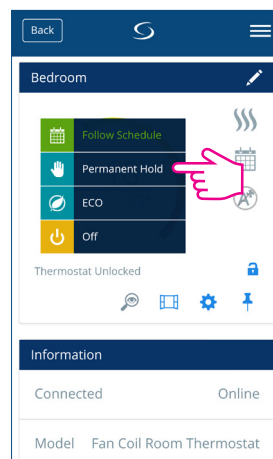

Tap hand icon .

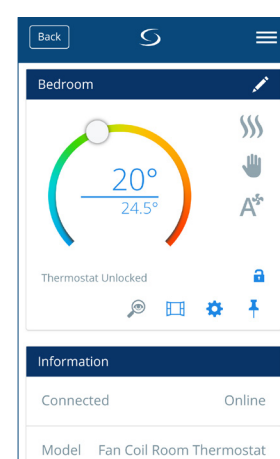

The thermostat is in permanent hold.

3.6.3. Eco Mode

When in Eco mode, the thermostat will use Eco set point to control room temperature. When Eco mode is activated, the Eco icon  will be displayed. To select Eco mode, follow the easy steps.

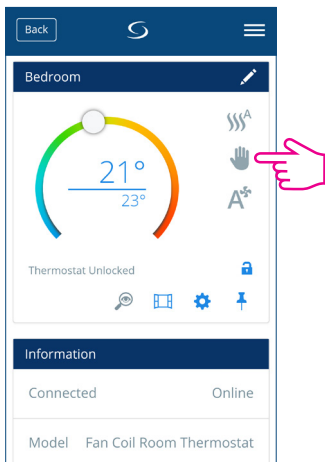

Tap the work status icon.

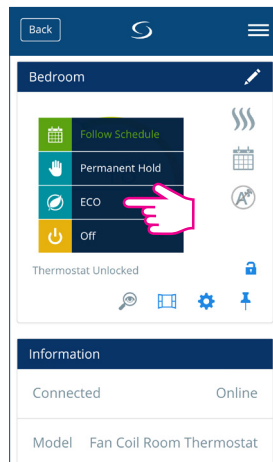

Select Eco Mode .

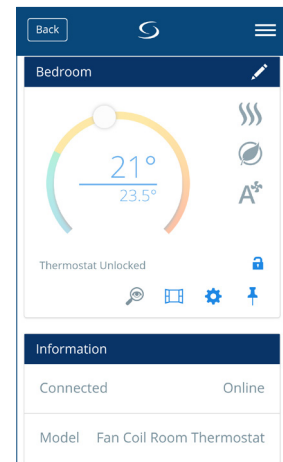

The thermostat is running in Eco Mode.

Note: When thermostat operates in Eco Mode, you cannot set a new temperature set point by sliding the cursor. After thermostat exists Eco Mode, it returns to the previous set mode.

Eco set point setting parameter is d10 for heating mode and d11 for cooling mode. The default set point temperature is 30°C for cooling mode and 15°C for heating mode. To change that, please refer to settings in Installer Section.

Note: If you have an occupancy sensor, then the Eco Mode will be activated automatically when the set up is complete. This is the default d34 setting. You can choose from either Eco or STANDBY mode.

Note: If the occupancy sensor is installed, the Eco Mode via app is disabled. On the LCD, the man in door symbol will be displayed if the occupancy sensor detects presence. When the occupancy sensor does not detect presence, the man in door symbol disappears and the Eco Mode via app is enabled. This is the default d34 setting. For more information regarding the installer mode, please check page 54.

3.6.4. STANDBY Mode

In STANDBY Mode all the outputs from the thermostat are off. It will still display the current room temperature and the thermostat will be working in Frost Protection. When the thermostat is running in STANDBY Mode, you cannot change the temperature set point or control the operations in any way. Please follow the steps below.

Note: After the thermostat exits Standby Mode, all the settings will be restored.

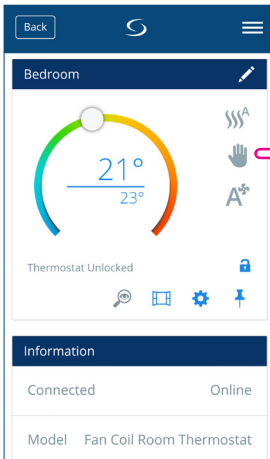

Tap the work status icon.

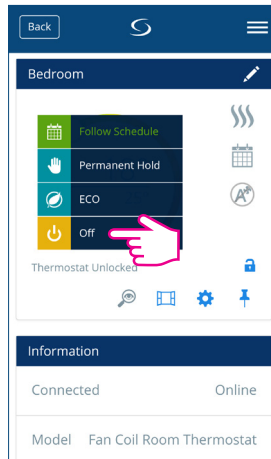

Select Off .

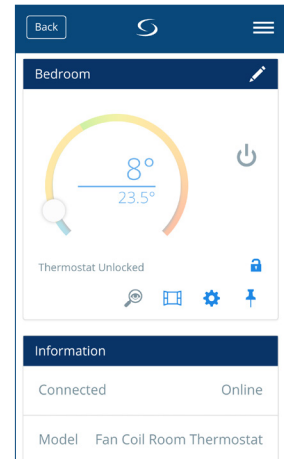

The thermostat is running in STANDBY Mode.

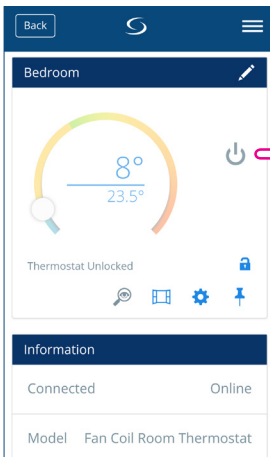

Tap On/Off icon.

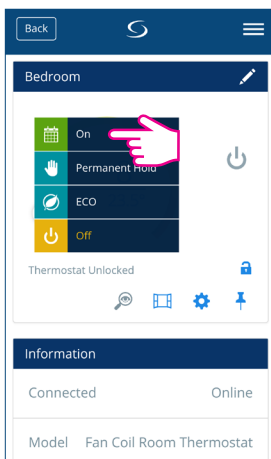

Select On .

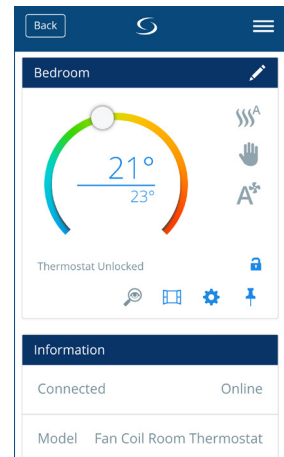

Thermostat in previous mode.

3.7. Setting a schedule for the thermostat

The Fan Coil gives you the possibility to set schedules for the thermostat. You can add up to 6 programs during one day, by selecting the program's start time and temperature. You can choose from 3 different schedule configurations:

- 5+2 (5 days same program + 2 days same program)
- Individual every week day
- All 7 days same program

Additionally, you can choose to set the Default schedules that already exist in the App, or to modify them according to your preferences. The schedules are displayed on the bottom of screen of your App on the selected thermostat. You can activate the schedules by pressing the Follow Schedule icon on your App.

 Once activated, the calendar icon  will appear on your screen.

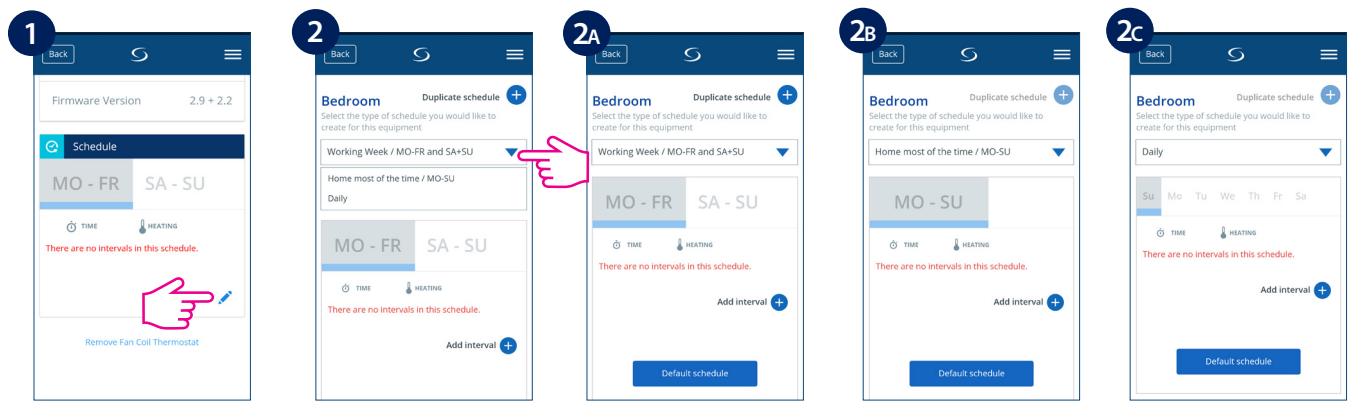

1 Go to your thermostat, scroll down and tap on pencil icon .

2 Click on arrow  and a drop-down menu with days options will be displayed.

2A You can choose Mon-Fri+Sat-Sun program (5+2).

2B All 7 days same program.

2C Individual every week day.

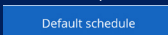
Note : Depending on your initial settings, whether you have selected or not a default schedule, the intervals will be displayed. If you didn't choose any default schedules, there would be no time intervals to display. You can always add default schedules by clicking the  button. Default schedules can be easily edited according to your preferences.

To add a program to your thermostat, follow the following steps to add interval and repeat as many times as needed.

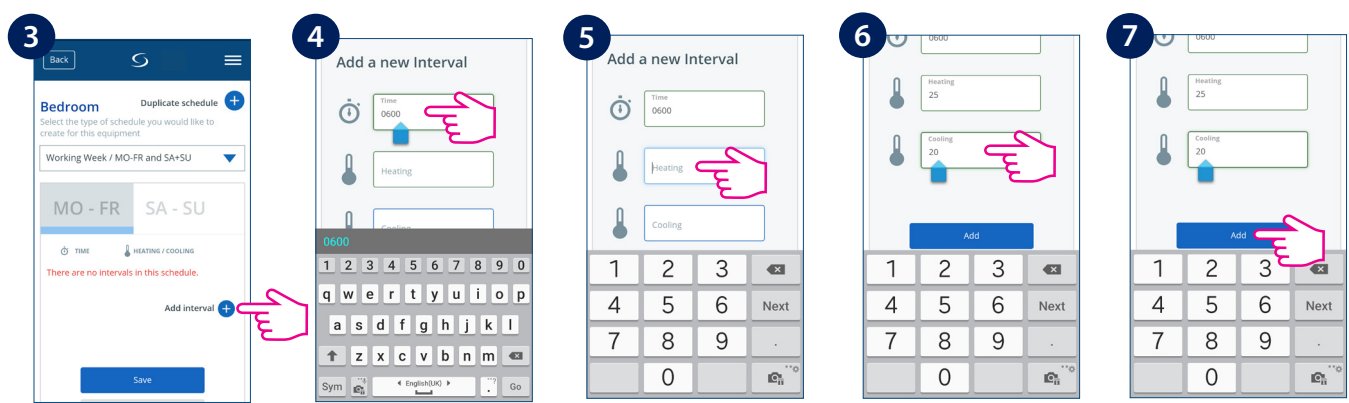

3 Tap **Add interval**.

4 Add a start time.

5 Add temperature for heating.

6 Add temperature for cooling.

7 To add interval, tap **Add**.

Note: The time should be in hh:mm format and the temperature value should be a number between 5 and 40. Decimal digits must end in 0 or 5.

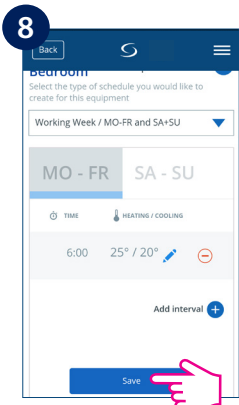

After you added the interval, tap **Save** to save it.

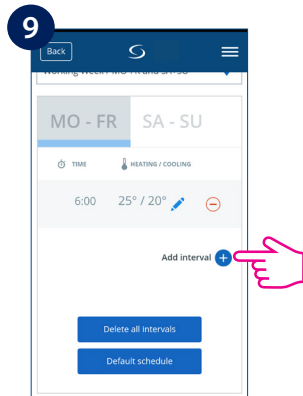

If you want to add more intervals, tap **Add new interval** and repeat the procedure as from step 4 to 8.

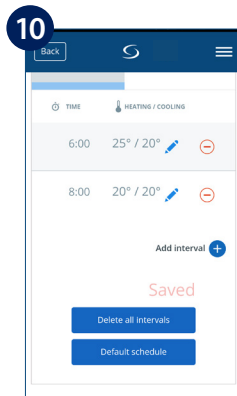

You can add as many intervals as you wish by repeating the procedure described from steps 4 to 8. The procedure is the same for all 3 schedule configurations. You can customize the programs on the thermostat in any way you want.

Note: If you selected Heating or Cooling ONLY in your initial setup, only ONE field (Heating or Cooling) will be displayed and only that one will require a value input.

If you want to add a default schedule, follow the steps below.

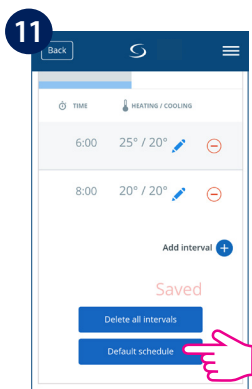

Tap **Default Schedule**.

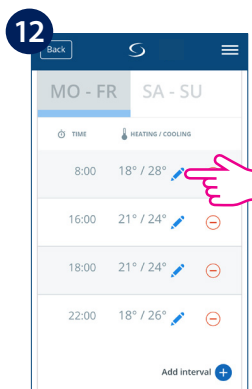

Default schedules are added. You can edit them by pressing the pencil icon .

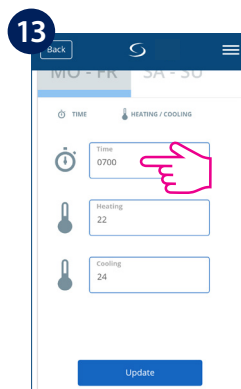

Make your changes using the steps 4-8 and tap **Update**.

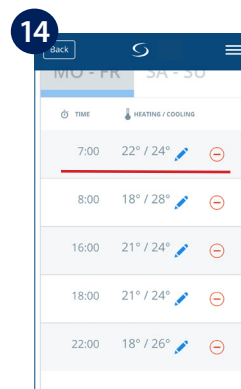

Your schedule has been successfully updated.

You can delete undesirable intervals by:

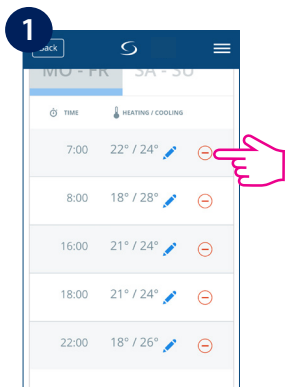

Tap Sign .

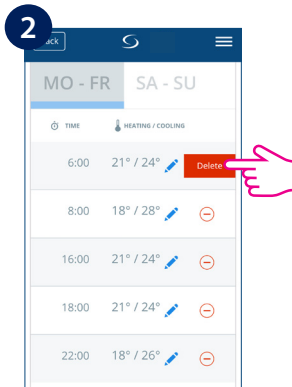

Delete button will appear. Tap it.

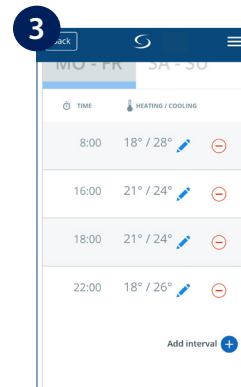

Interval deleted.

3.8. Fan Control

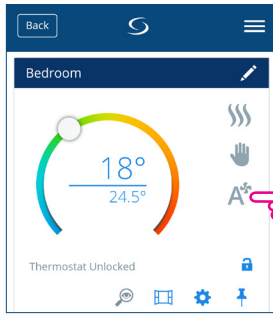

Tap on fan icon.

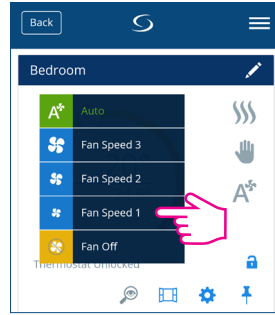

Choose fan speed.

Tap the fan icon on your App screen and a sub-menu with fan speeds (1-3, Auto and Off) will appear. Make your selection.

By default, the Fan is on only when the Fan Coil calls for heating or cooling. You can change the default setting by changing parameter d38 in Installer Mode. On details regarding the installer mode, please check page 55. In program mode, the default fan mode is automatic. The fan mode can be changed to Manual by pressing the Fan button. The fan returns to the automatic default mode until next program time.

The fan is controlled by the TPI method. TPI is a learning algorithm for the fan. It tells the fan in which speed it has to run in order to be most economy efficient. Not that it only sets the speed depending on the difference between the room temperature and the set point temperature, it also figures out the thermo patterns in your house/office to result into the best energy saving plan.

3.9. Key lock function

The application gives you the possibility to lock the keys on your device. Simply tap the lock icon  on the screen to lock. To unlock, tap it again. When the keys are locked, the user can't press any keys on the device.

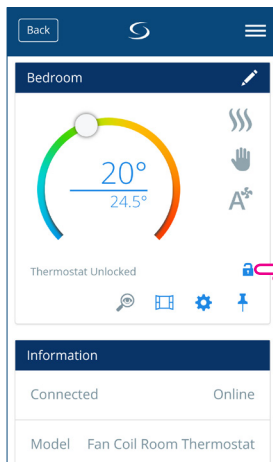

Tap lock icon .

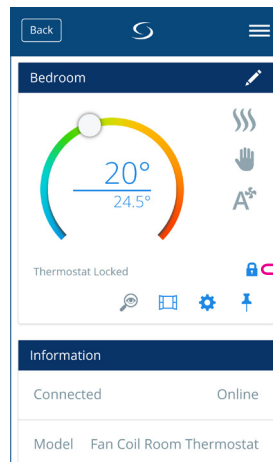

Thermostat locked. Tap  to unlock.

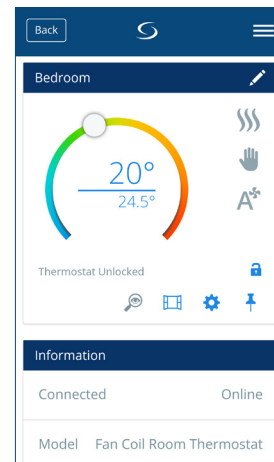

Thermostat unlocked.

You can also change the key lock settings in parameter settings, by changing the d37 value in Installer Mode. Please check page 55.

3.10. Occupancy Sensor

If you have an occupancy sensor connected to your S2 terminal, for example a hotel card, it will also show on the App. When the card will be inserted, meaning man in room, the icon will be displayed on your screen. Otherwise, an empty door will show. The user can define if thermostat should go to ECO mode or STANDBY mode when there is nobody in the room, by changing the parameter d34 in Installer Menu.

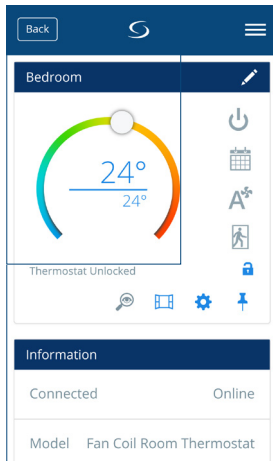

Man in room .

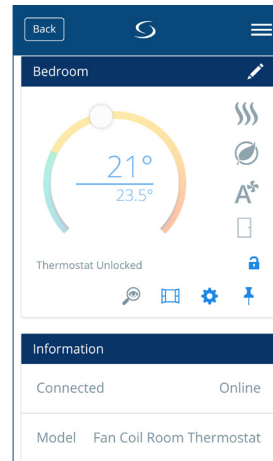

Empty room  -
thermostat in Eco Mode.

3.11. Window Association Function

The window sensor associated with the thermostat will allow you to create certain rules when the window is closed/open. If the information about an open/closed window is received during one of the programs (when the thermostat is following a schedule), then the rule will be applied until the next program starts. Also, you can choose that the thermostat will follow the previous mode after the window is closed. In order to have this function available, you need to have window sensor added to your system and add it to the thermostat. Please see below.

To add a window sensor to your system, please refer to OS600 manual on www.salus-manuals.com

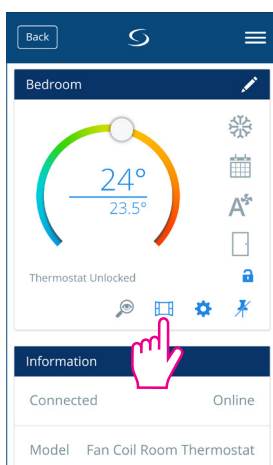

Tap window icon .

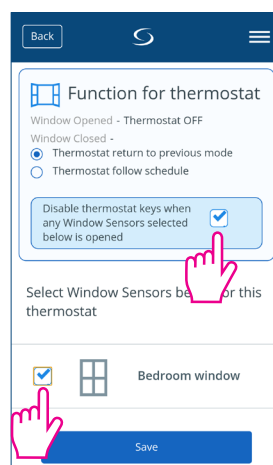

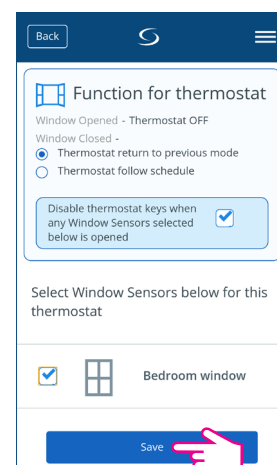

Select the option and the associated sensor.

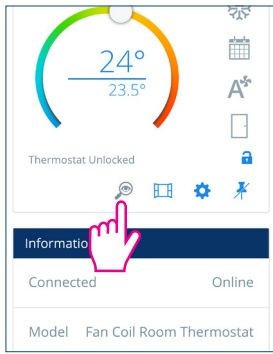

Tap **Save** to save your settings.

3.12. Identification Function



Tap the magnifying glass icon  on your App screen. The screen on your device will go to identification mode - it will flash On/Off during 10 minutes. Tap it again to stop identification mode.

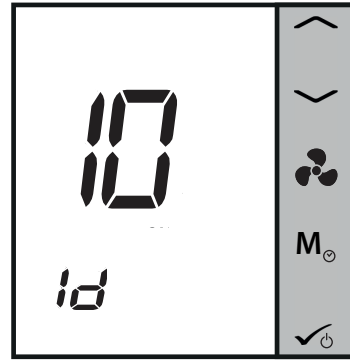

3.13. Pin / Unpin thermostat to the dashboard

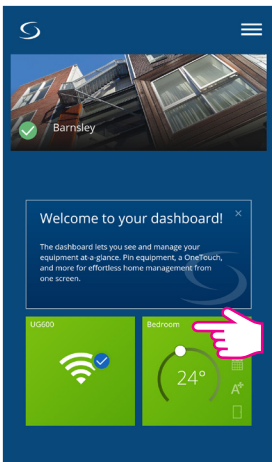

Tile is visible.

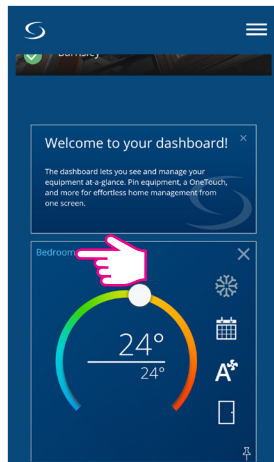

Thermostat is pinned to the dashboard.

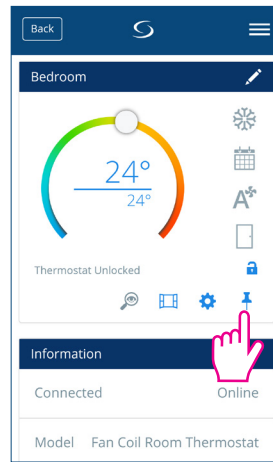

Thermostat is pinned to the dashboard. Tap  to unpin.

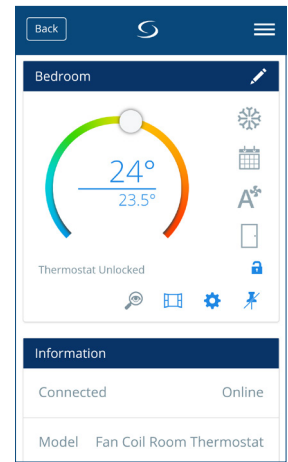

Thermostat unpinned.

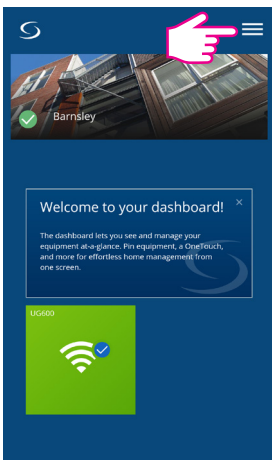

Tile is no longer visible. To access the thermostat go to Menu.

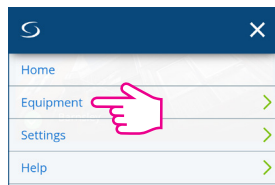

Tap Equipment.

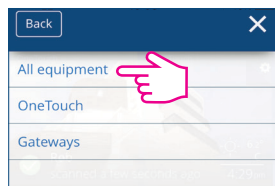

Tap All equipment.

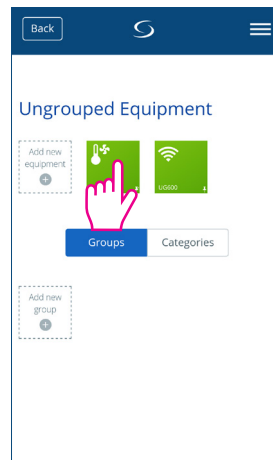

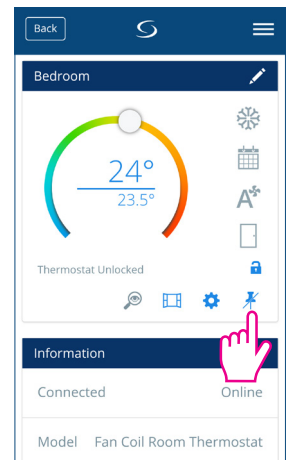

Tap thermostat.

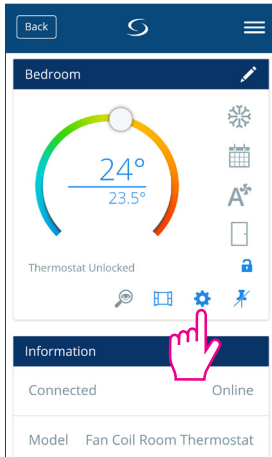

Tap  to pin back.

3.14. Service Settings



Tap the gear icon  to enter settings. This menu allows you to change settings on your thermostat. You will have to enter a special password in order to access the settings menu.

Please read more in the Installer Manual section about more detail on how to access the settings with a full description of the parameters. See page 51.

3.15. Using / Adding OneTouch

OneTouch is a set of rules that can be applied to your thermostat. You can choose to enable or disable them any time. OneTouch tells your thermostat exactly how to behave depending on your input. There are 3 predefined OneTouch rules in the App:

- **Party mode** - sets the thermostat on 21 C for 2 hours
- **Run comfort temperature** - Set thermostat to 21 C
- **Run frost mode** - Set thermostat to frost mode

To activate a pre-existing OneTouch, please follow the steps below. For example, you want to set the Party Mode OneTouch

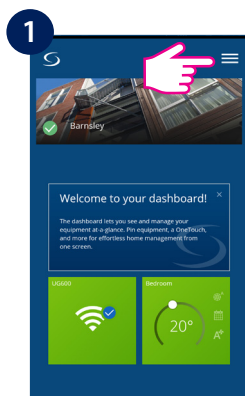

Tap the menu icon .

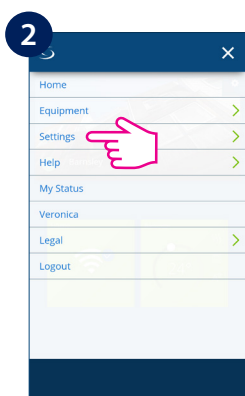

Select **Settings**.

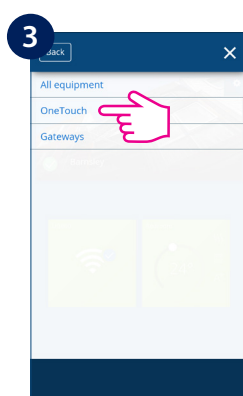

Select **OneTouch**.

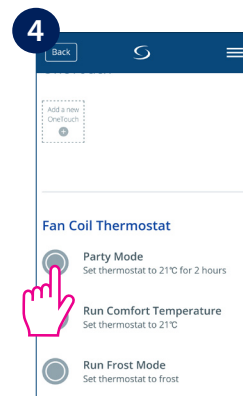

Tap on **Party Mode**.

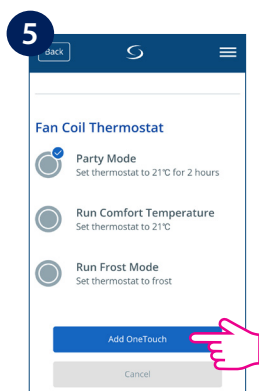

Tap **Add OneTouch**.

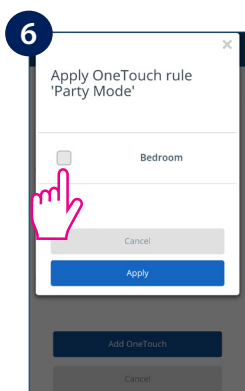

Choose devices you want to apply the rule to.

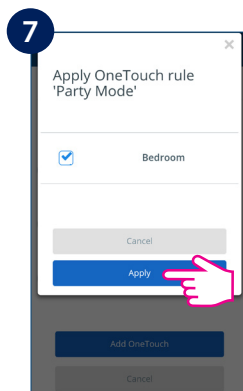

Tap **Apply**.

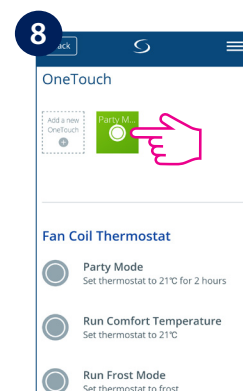

The OneTouch is added.

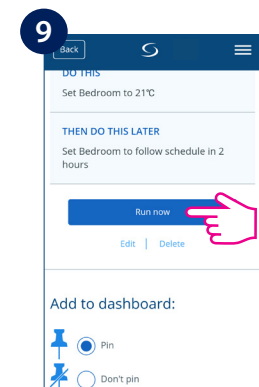

Press the button to get the OneTouch running.

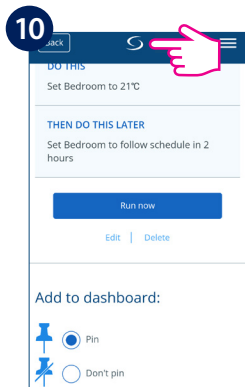

Go to home screen by tapping .

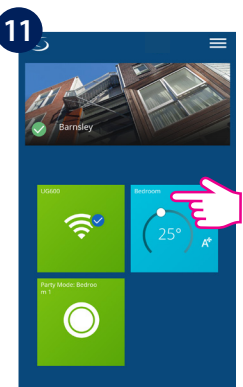

One Touch tile  appears on your home screen and thermostat went blue meaning it is cooling down.

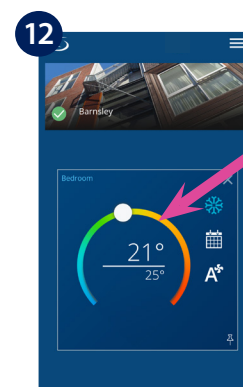

Your thermostat is set to 21°C.

4. Installer Manual

4.1. Box Contents

Your box should contain:



Front housing of the Fan Coil

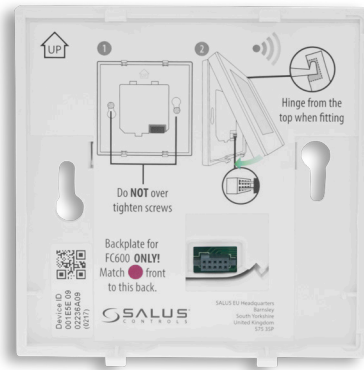

Rear housing of the Fan Coil

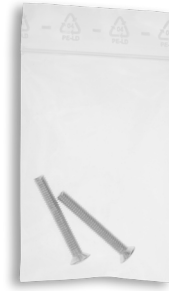

Two screws for wall mounting



Quick Guide

4.2. Proper positioning of the thermostat

The ideal position to locate the FC600 thermostat is about 1.5m above floor level, in a location where the thermostat is accessible, reasonably lit and free from extremes of temperature and draughts. Do not mount the thermostat on an outside wall, above a radiator or in a location where it may be subjected to direct sunlight.

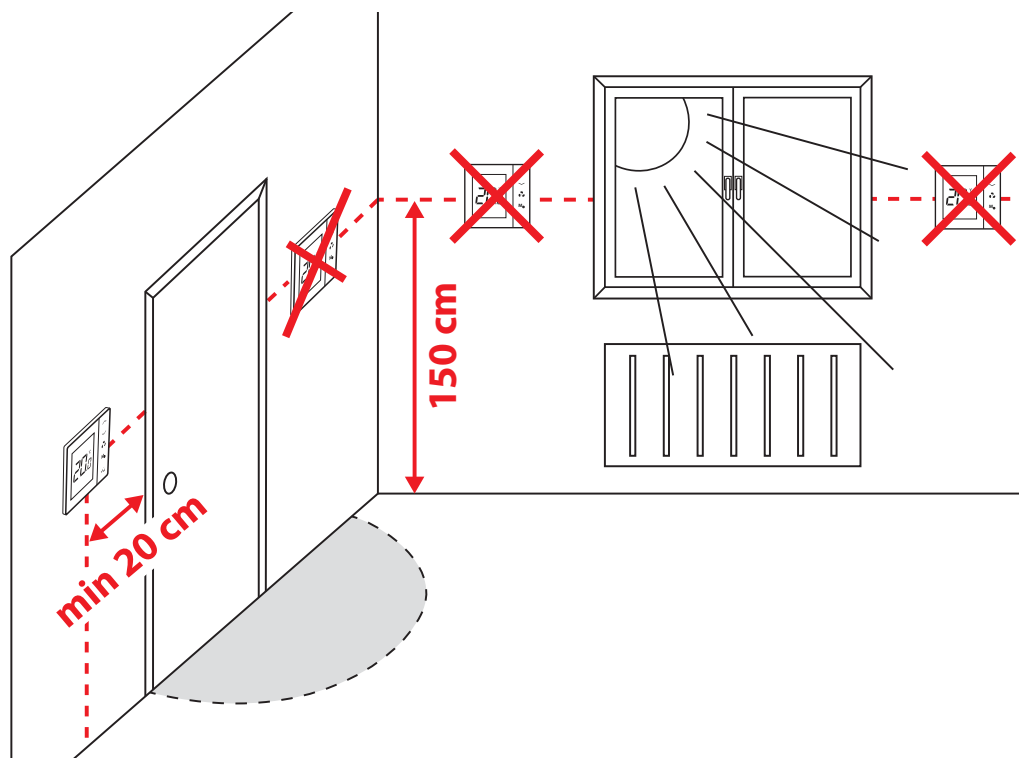

4.3. Idea diagrams

Below you can find some possible usage diagrams for the Fan Coil thermostat, depending on the on your system and components.

- **2 pipe, heating only**

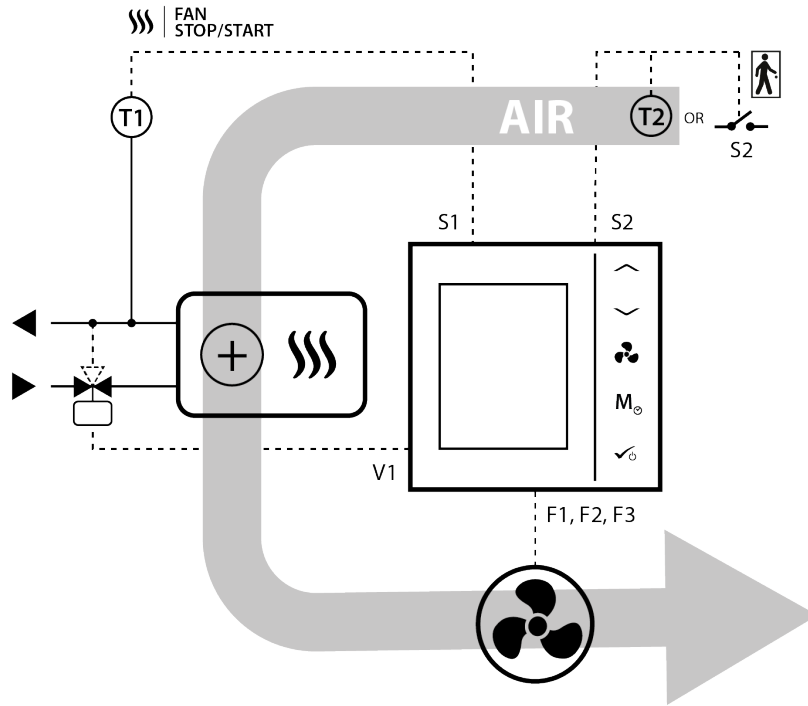

- **2 pipe, cooling only**

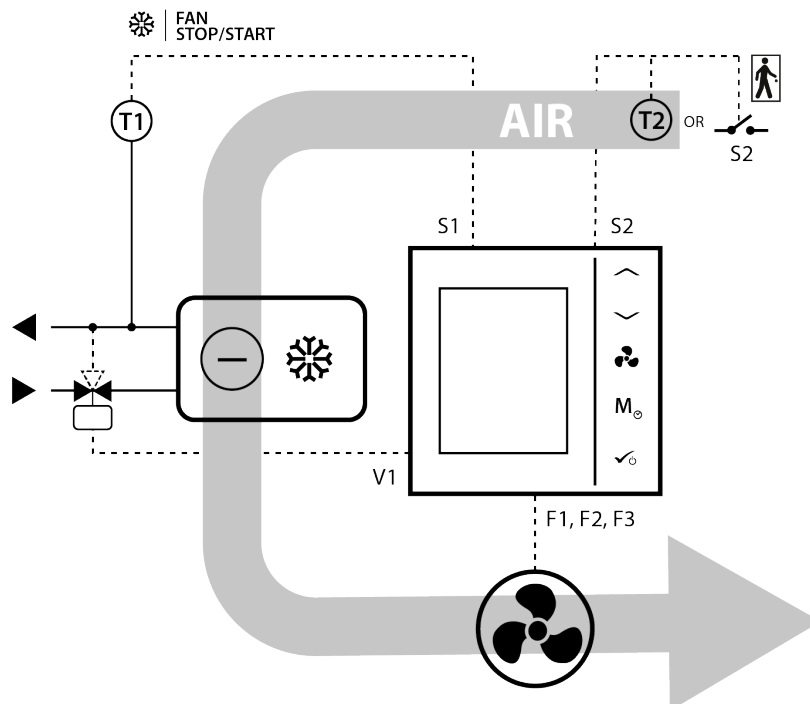

- 2 pipe, heating OR cooling

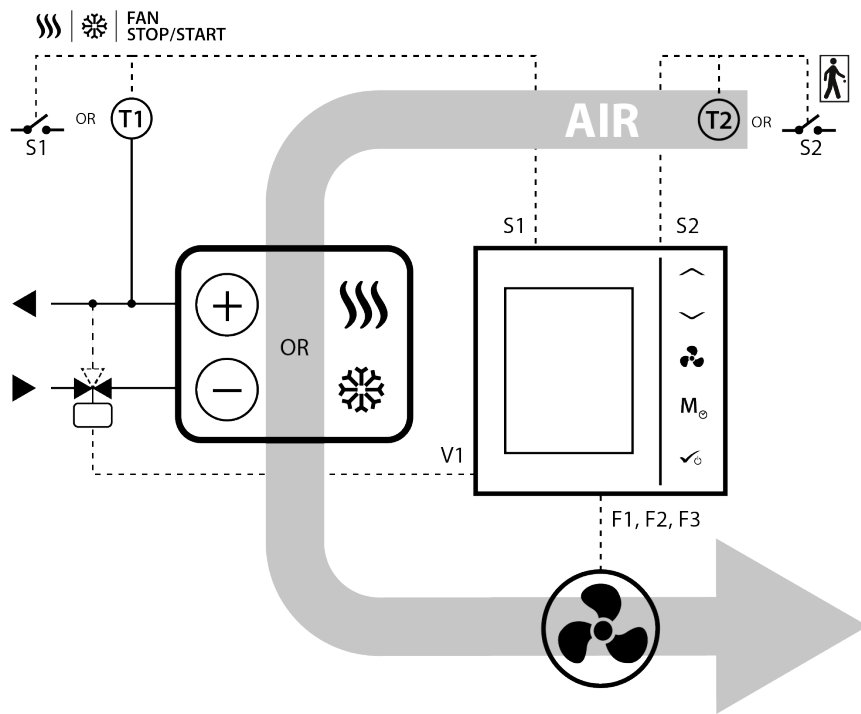

- 4 pipe, heating AND cooling

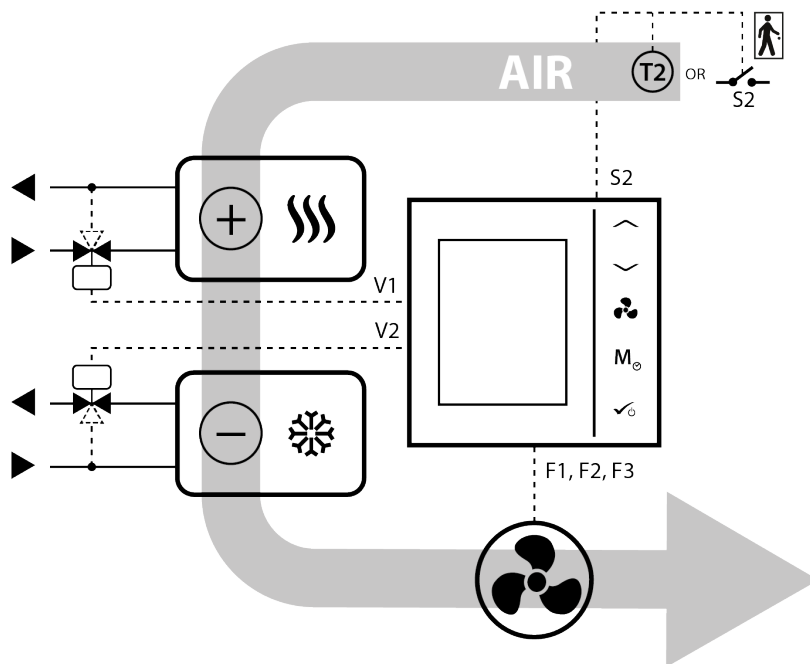

- 4 pipe, heating AND cooling + S1 changeover switch

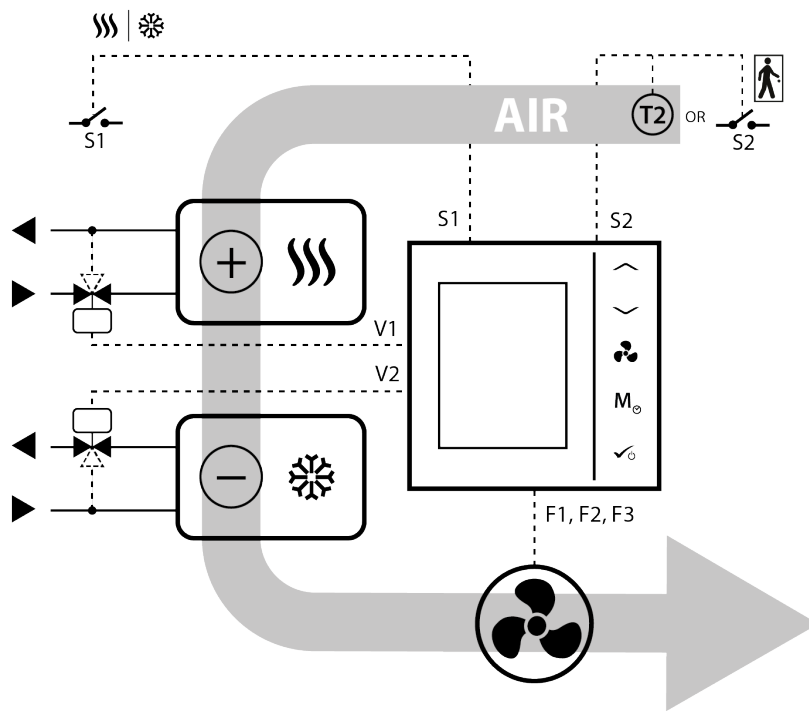

	Heating mode
	Cooling mode
	External switch (ON/OFF) (heat/cool changeover)
	External switch (ON/OFF) (e.g. an occupancy sensor, launching ECO or Standby mode)
	Pipe temperature sensor (allows the fan to be working or not)
	Air temperature sensor or external room temp. sensor (FC600 will display temperature from the sensor connected to T2. Internal temperature sensor will be ignored)
	Motorized valve / actuator
	3-gear speed fan
	Heating device
	Cooling device
	Heating or cooling device (2-pipe system only)



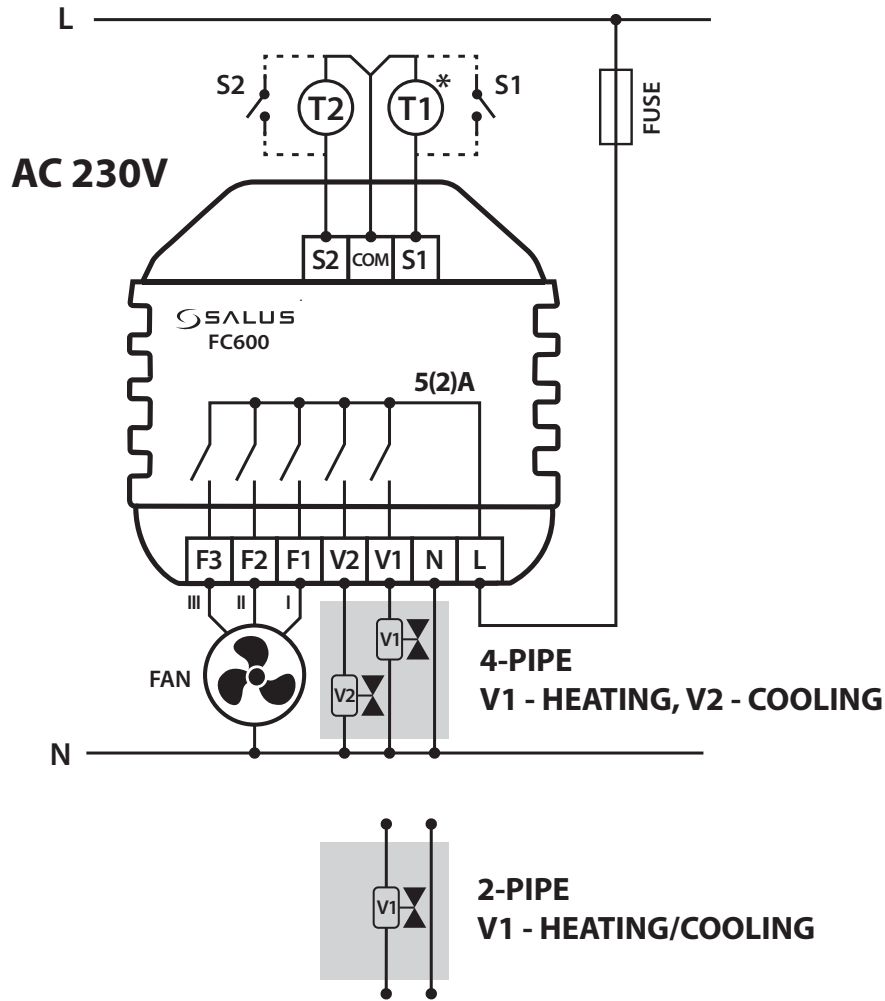



4.4. Wiring options



Terminals description

Terminal	Function
L,N	230V AC power supply
V1	4 pipe: Heating valve output - 230V AC 2 pipe: Heating or Cooling valve output - 230V AC
V2	4 pipe: Cooling valve output - 230V AC 2 pipe: N/A
F1	• Fan Speed control (Low level) - 230V AC
F2	• Fan Speed control (Medium level) - 230V AC
F3	• Fan Speed control (High level) - 230V AC
S1	Heat/Cool changeover (or pipe sensor - only in 2-pipe system)*
S2	Occupancy sensor or external sensor
COM	Common Terminal

Icon description

-  - 3-gear speed fan
-  - Fuse
-  - External switch (ON/OFF) - heat/cool changeover
-  - External switch (ON/OFF)
e.g. an occupancy sensor, launching eco mode
- * - Pipe temperature sensor - allows fan to work
*(only in 2-pipe system)
-  - Air temperature sensor or external room temp. sensor
(active T2 sensor disable temperature measurement in thermostat)
-  - Zone valve

4.5. Terminals explanation

Note: If you are using an external sensor please make sure that you are following the sensor instructions below and also that all the setting are done accordingly on the fan coil.

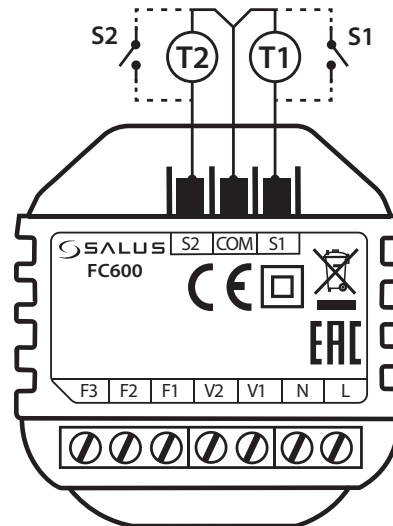

S1 Terminal connection

S1 NoFn	S1 HCCO	S1 Auto	S1 SenS
<p>No function</p> <p>Nothing is connected to S1/COM terminal. The Heat/Cool can be changed only manually using the Mode button or the App if both modes are available.</p>	<p>Heat/Cool Changeover</p> <p>When the S1/COM terminal is open, the Heat function is activated.</p> <p>When the S1/COM terminal is closed, the Cool function is activated</p>	<p>Auto Heat/Cool Changeover</p> <p>In 2 pipe system - S1 = Auto, the pipe temperature sensor is connected, and it is deciding in what mode the thermostat should be working.</p> <p>In 4 pipe system - S1 = Auto - it means nothing is connected to S1/COM, and thermostat is measuring the room temperature to select the Heating or Cooling mode.</p>	<p>Fan Sensor</p> <p>Available for 2 pipe only. Pipe sensor is connected to the S1/COM terminal. Pipe sensor is used to allow the fan to run or not. Heat/Cool selection is done manually.</p>
<p>Default setting: S1 NoFn</p>			

S2 Terminal connection

S2 NoFn	S2 Door	S2 SenS
<p>No function</p> <p>Nothing is connected to S2/COM terminal.</p>	<p>Occupancy sensor</p> <p>Occupancy sensor is connected to the S2/COM terminal (e.g.: hotel card).</p>	<p>External temperature sensor</p> <p>The temperature read by the sensor will be displayed on the Fan coil LCD. The internal sensor in the Fan coil will not be used.</p>
<p>Default setting: S2 NoFn</p>		

The S1/COM Terminal

The S1/COM terminal responds for the heat/cool changeover. It can operate in 4 different modes, depending on what is connected to the terminal.

2 or 4 pipe S1/COM	2 pipe	4 pipe
NoFn	No Function , means that there is nothing connected to the terminal and that the Heating/Cooling mode will be changed manually by the user when operating the Fan Coil via device or the App. Heating/Cooling mode cannot be changed via changeover sensor / switch; it will remain in the last mode as selected locally via button or App.	
HCCO	Heat/Cool Changeover via External Switch - an external Switch is connected to the thermostat and depending on its position the end user can control the Heating/Cooling modes on the thermostat. When the switch is open the thermostat enters Heating Mode, when closed - Cooling Mode. The primary usage for this setting is when you have a thermostat in one room, but wish to operate its mode from a different location (for example you have several thermostats in different rooms and the Heat/Cool switch placed in the boiler room).	
Auto	Auto Heat/Cool changeover via Pipe Sensor. An external pipe temperature sensor is connected to the S1/COM terminal. The temperature detected by the pipe sensor (i.e the water temperature inside the pipe)is used to change over from heating to cooling mode, or vice versa. When the pipe temperature is above e.g. 30 °C(parameter d25), the thermostat changes over to heating mode; and to cooling mode when below e.g.10°C (parameter d24). If the pipe temperature is between the 2 changeover points after power-up, the thermostat starts in the previous active mode. The pipe temperature is acquired at 30-second intervals and the operating state is updated accordingly. Note: The temperature detected by the pipe sensor is NOT the temperature displayed on your LCD. The screen of the thermostat displays the room temperature, detected by the internal temperature sensor. The information regarding the pipe temperature is used by the thermostat to ONLY switch between Cooling/Heating Mode and turn On/Off the fan, if selected.	Auto Heat/Cool changeover via "dead zone" function. For a 4 pipe configuration there CANNOT be an external pipe sensor connected. The thermostat controls 2 valves in Heating and Cooling Mode. Terminal V1 is used for the Heating valve, while terminal V2 is used for the Cooling valve. The Heating/Cooling mode changeover temperature is the one detected by the internal temperature sensor.
SenS	An external pipe sensor is connected to the S1/COM terminal, that tells the fan to run or not. The type of sensor connected to the S1/COM terminal need to be NTC 10kOhm.	N/A

The S2/COM Terminal

The S2/COM terminal is used for connecting external sensors as occupancy or external temperature sensor. It can operate in 3 different modes, depending on what is connected to the terminal.

Note: The S2/COM terminal has the same usage for either 2 or 4 pipe configuration.

Sensor \ 2 or 4 pipe	2 pipe	4 pipe
NoFn	No Function - nothing is connected to the S2/COM contact. No information is provided to the thermostat.	
Occupancy sensor	Occupancy Sensor - occupancy sensor is connected, meaning that the thermostat can get information depending on the input from this terminal and different rules can be created. An example of an occupancy sensor is the hotel card - once the hotel card is inserted, the thermostat can operate following a schedule it can go to ECO mode or STANDBY mode (defined by d34 parameter). Occupancy sensor can be used in 2 pipe or 4 pipe applications.	
External Temperature Sensor	External Temperature Sensor - External Temperature sensor is connected. Once the sensor is connected, the thermostat will display on the LCD the temperature from that sensor, ignoring the internal sensor. It can be used as an extension for the thermostat, saying you have a thermostat operating a room that you don't have access to or is inconveniently remote. Please note that if you don't have any sensor installed, but selected S2 as external sensor, there will be no temperature to display, as there will be no source for the thermostat to gain data from. Can be operable with any d2 value. The sensor should be NTC 10kOhm.	

4.6. Wall Mounting

Caution: Due to the risk of injury, the thermostat is designed for use in the environment marked as 2 degree of pollution according to the PN-EN 60730-1. In addition, the thermostat can not be used in condensed conditions or be exposed to water.

Caution: The installation must be carried out after the thermostat is disconnected from the power supply. Connecting the mains voltage 230V ~ to the sensor terminals effectively damages the thermostat and creates danger of electric shock. Before power up, check if the wires are properly connected.

1

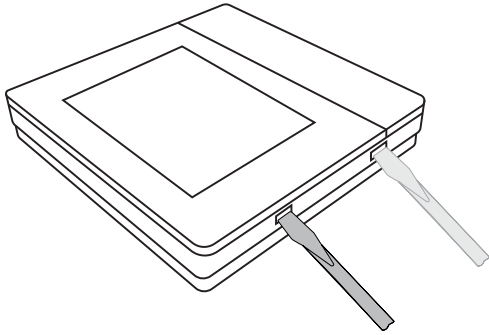

Remove the front cover by prying hooks with flat screwdriver at the bottom of the front panel.

2

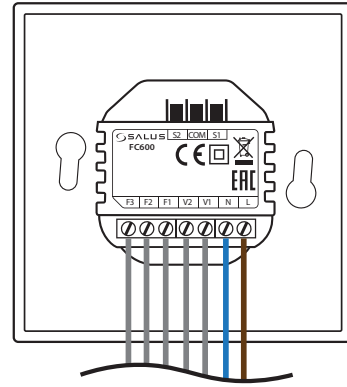

For the convenience of installation, the first step is to wire the volt-free wires, then low-voltage wires (S1, S2, COM). Check that wires are properly connected.



The ends of the connecting wires must be protected against delamination using insulated sleeves as shown in the figure below:

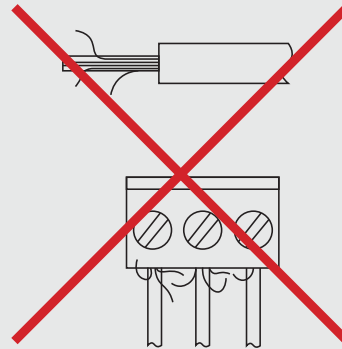
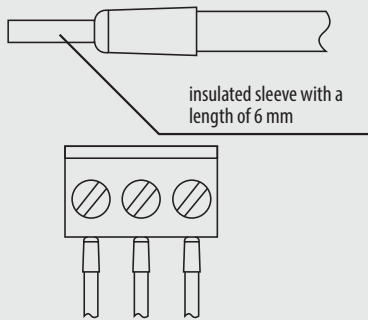

3

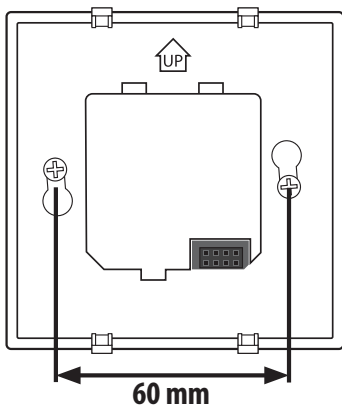

FC600 is designed for flush mounting in a 60 mm wall box. Make sure the back cover is in place in the appropriate position (according to the arrow on it).

4

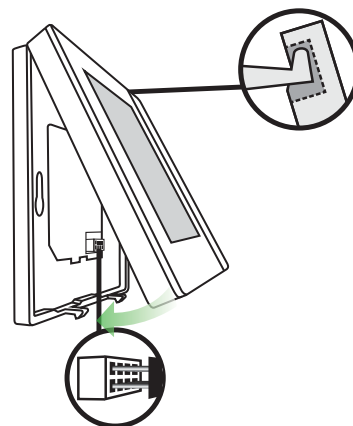

Fit the front part of the casing to the top edge and make sure the pins are properly positioned. Push the front of the casing until you hear positive click.

4.7. Online Mode (with internet connection)

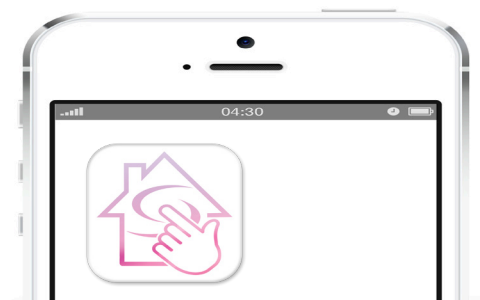

First make sure that you have downloaded the Salus Smart Home App from the Google Play or App Store. You will need to follow a few easy steps to create an account and then link your Fan Coil to the Universal Gateway and to the App.

You can also access the web version at: <http://eu.salusconnect.io/>



To begin the pairing process the Gateway should be plugged into the power source and connected to the Internet. Also, make sure that the UG is added to your Salus Smart Home App. For the installation of the Universal Gateway, please refer to the UG600/UGE600 manual at www.salus-manuals.com



Make sure that your Universal Gateway is added to the App. The LED of the Gateway should be steady blue. Once you have that installed, go to your Fan Coil and begin pairing it with the UG and adding it to the App.

- Short press OK to confirm.
- Short press button to confirm pairing. At this point you should go to the App in order to configure your Fan Coil.
- Now go to the App. Tap menu icon

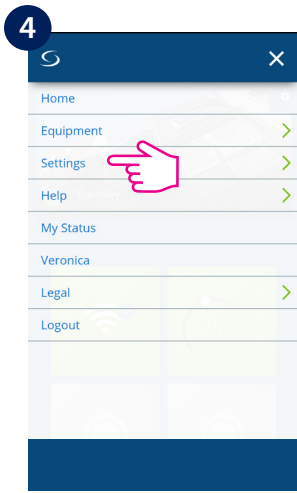

Tap **Settings**.

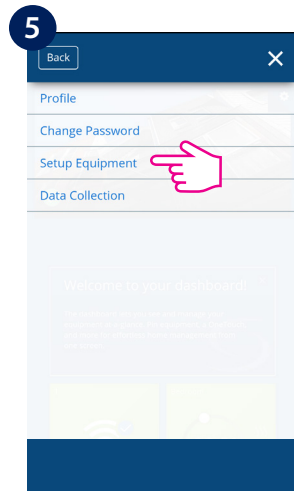

Tap **Setup Equipment**.

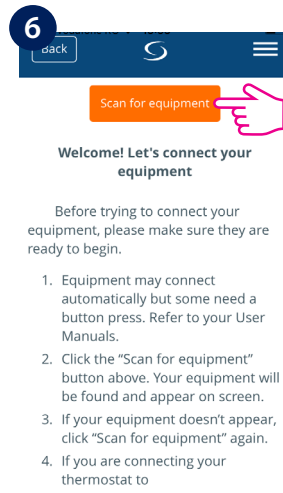

Tap **Scan for equipment**.



When new equipment is being added, the UG should flash red.

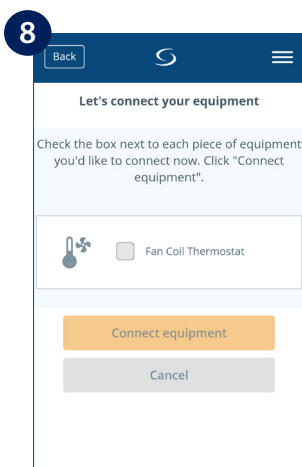

The Fan Coil should appear on screen.

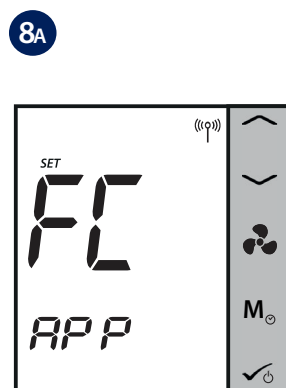

The Fan Coil will go automatically into FC App screen.

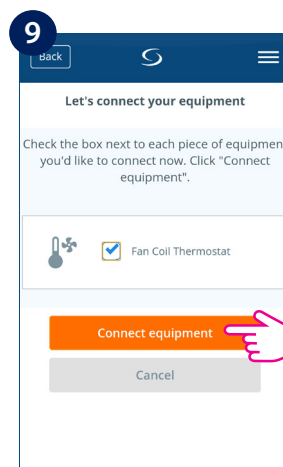

Select device and tap **Connect equipment**.

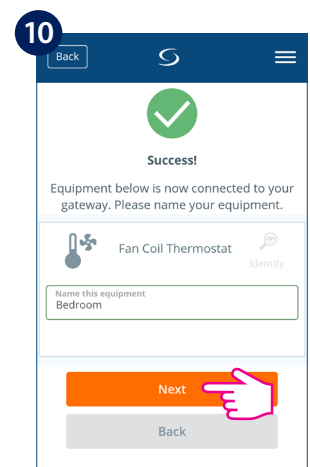

Rename your device and tap **Next**.

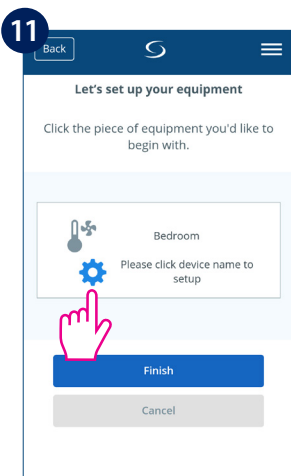

Now, set your Fan Coil according to your system.



You can choose the OneTouch now or later. For more info on one Touch, please check page 35. This will NOT influence your settings.

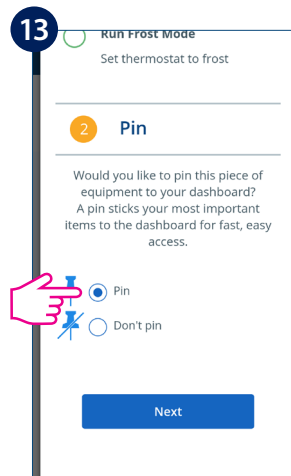

Scroll down and choose to **Pin** the Fan Coil to your dashboard. Tap **Next**.

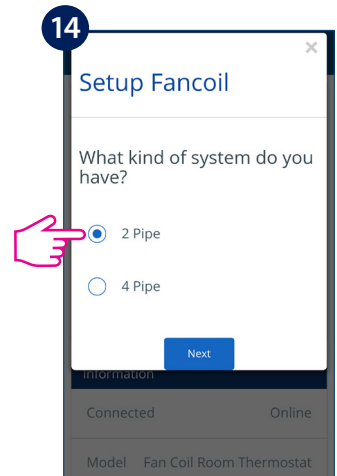

Select your type of system: **2 Pipe** or **4 Pipe** configuration and then tap **Next** to go to the next step.

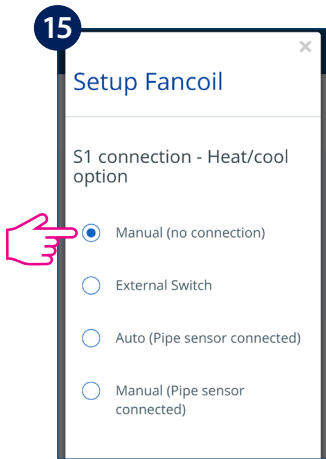

Choose your heating/cooling option and tap **Next**. Please read the notes below regarding the heating/cooling options on your system.

Note 1: When first configuring your Fan Coil, there will be some differences on the App setup depending on either you have a 2 or 4 pipe system.

Note 2: If you choose a 2 pipe system with manual heating/cooling option, you will have to follow the extra steps 16-18.

Note 3: For a 2 pipe system with External switch or Sensor heating /cooling option and for a 4 pipe system, regardless of your heating/cooling option, the App setup wizard will jump to step 19.

Note: Steps 16-18 apply ONLY with you have a 2 pipe system and selected Manual heating/cooling option.

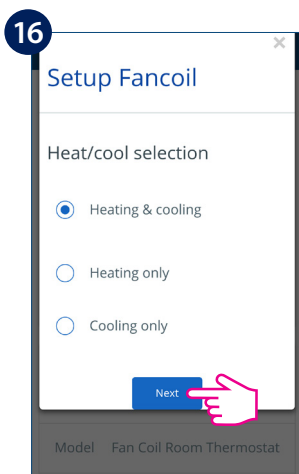

Select if you want to use your Fan Coil for heating, cooling or both. Tap **Next**.

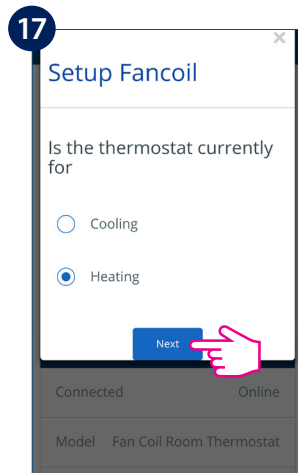

Please specify for what you will use the thermostat. Tap **Next**.

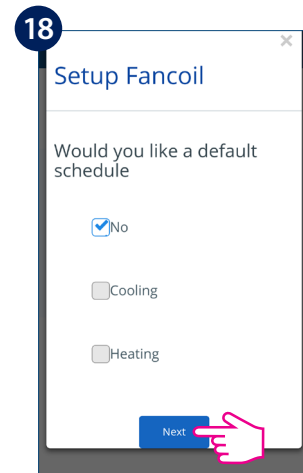

Choose whether you want a default schedule for heating or cooling. More on how to create/use schedules on page 26.

Note: If you selected any other option besides the one described above, the App will take you to:

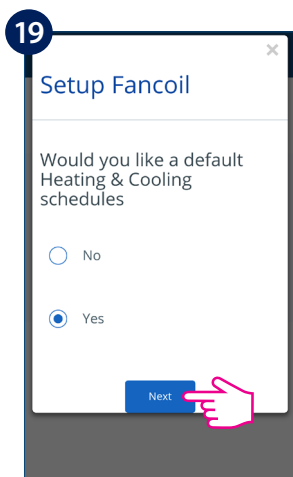

Choose if you would like a default schedule. Tap **Next**.

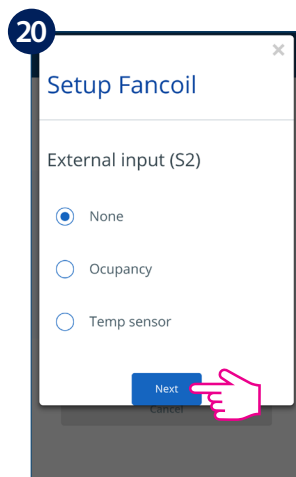

Select if you have any external inputs on S2 sensor. Please see page 41 on external sensors. Tap **Next**.

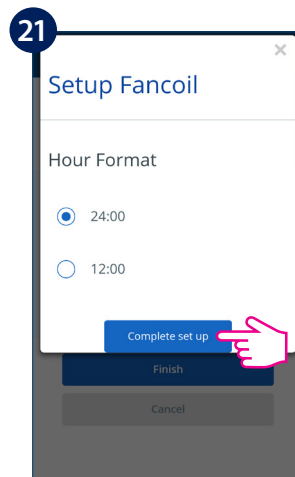

Select your preferred hour format. Tap **Complete setup**.

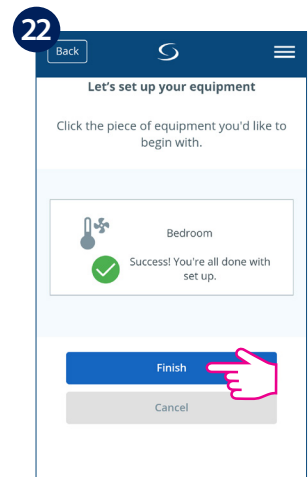

Now your setup is complete. Tap **Finish** to go to the next step. The Fan Coil tile will appear on your screen.

Note : If you clicked on External Sensor, but have none connected to the thermostat, your Fan Coil will not display any temperature. After you clicked Finish and completed your setup, you cannot change the initial settings through the App. You will need to remove and re-install your Fan Coil, choosing the correct options. Please see page 60 on how to remove your thermostat from the App and reset it. After you click Finish, your thermostat will enter STANDBY mode.

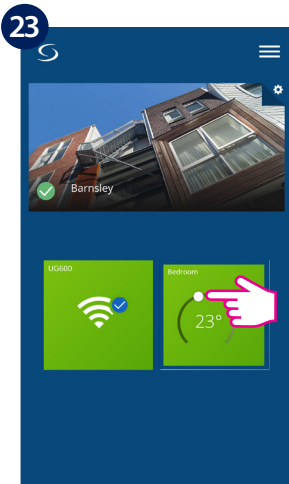

Click on thermostat tile to enter your thermostat.

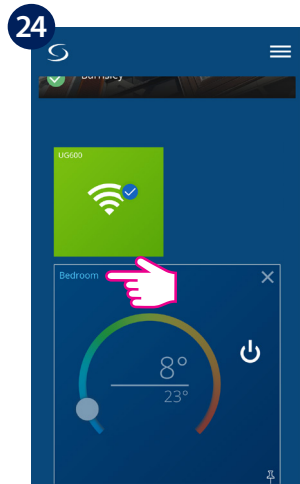

Click on thermostat name to enter main screen.

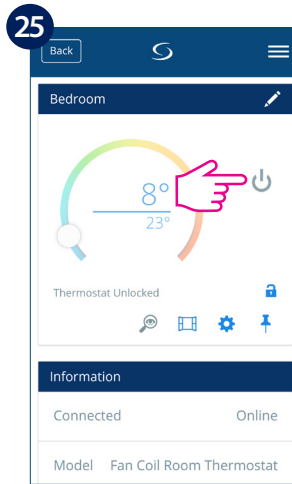

Click on On/Off icon to turn on your thermostat.

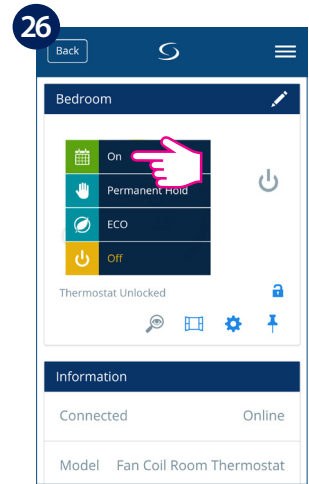

A sub-menu will appear on screen, tap On to turn on your thermostat.

After you see the Fan coil tile on your dashboard, please allow a few minutes for all the settings to properly install. After you turned your thermostat On using the App, the screen on both your thermostat and App will change, showing your initial settings. At this point you can start adding schedules and using your thermostat from the App, or on the device itself. Please see next page for a list of icons displayed on the screen in your App. For a full list of icons on your Fan Coil screen please see page 6.

4.8. Installer Parameters

4.8.1. In Offline Mode (with no Internet connection)

Installer Mode is an advanced menu, where the user can access all the thermostat's settings. It can be accessed from the device when FC600 is working in local mode (without Internet connection). To enter Installer Mode (in offline mode ONLY), follow the steps below:

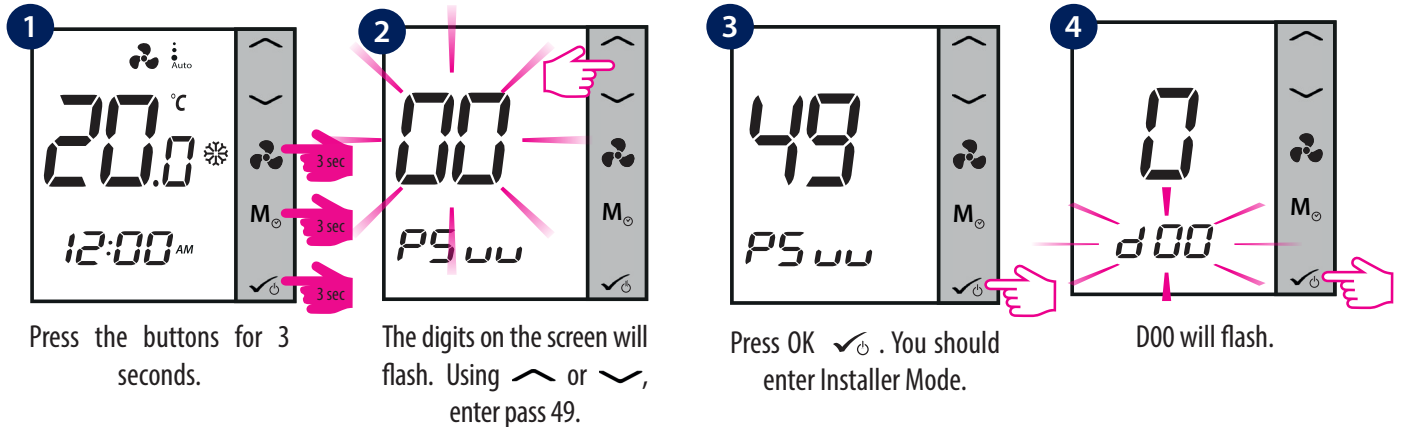

There are numerous settings that can be set and changed, please find a description of all the function later in the chapter. The dx parameter is the number of the setting and the number above is the value given to the setting. In the table you will find all the settings and their values described.

Note: This mode (Installer Mode) is NOT available on the device when the Fan Coil is connected to the Internet. To change the installer parameters when the device is connected to the App, please see the page below.

4.8.2. Switching from non-programmable to programmable thermostat

After first power up, FC600 is non programmable by default. If you would like to switch it to programmable thermostat in local mode, please follow below steps:

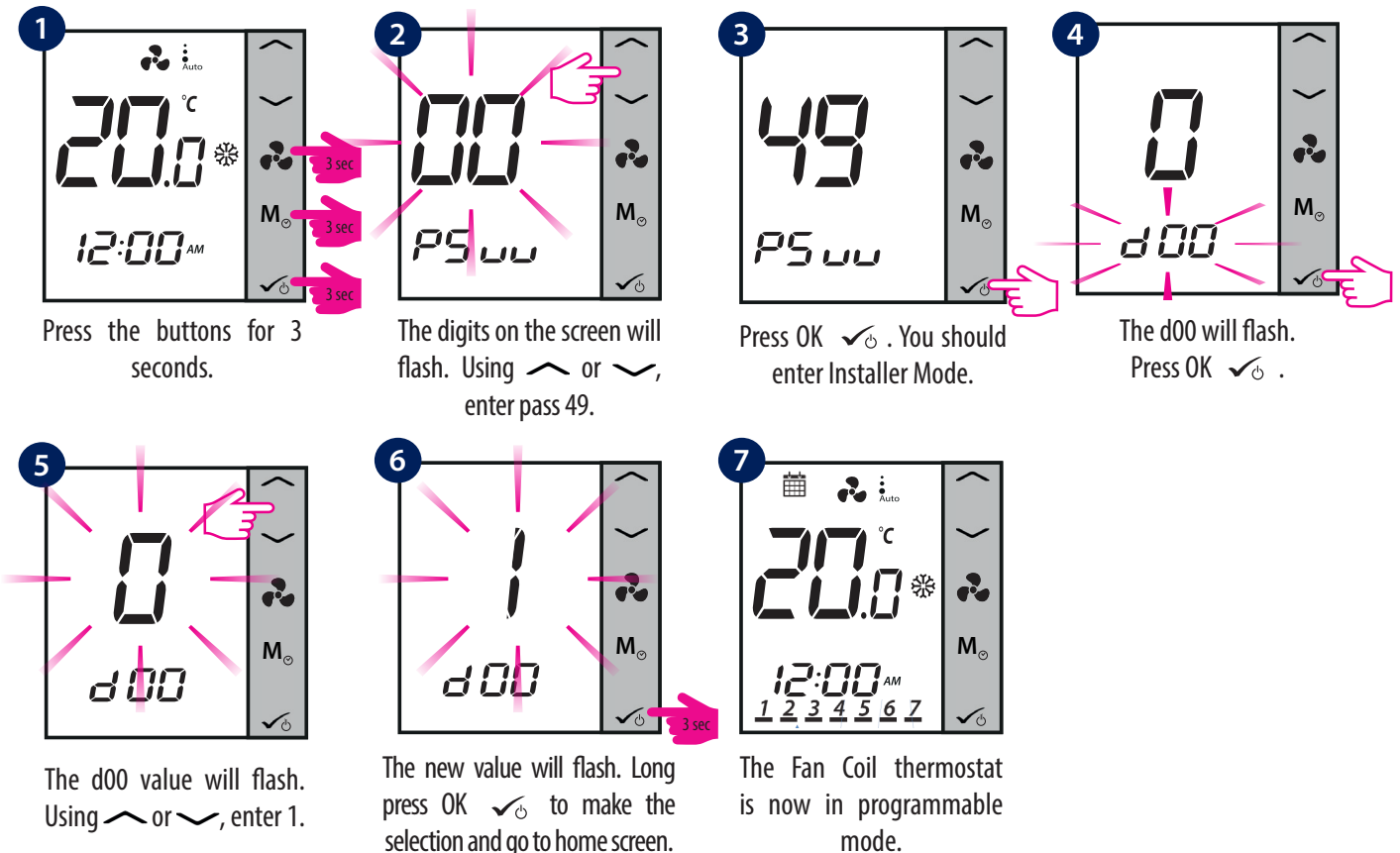

4.8.3. In Online Mode (via App)

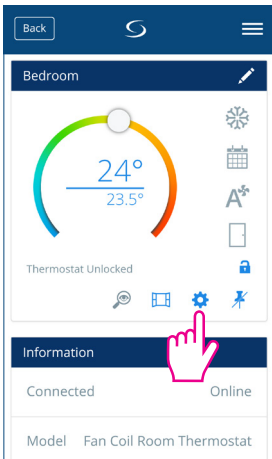

Tap the gear icon  .

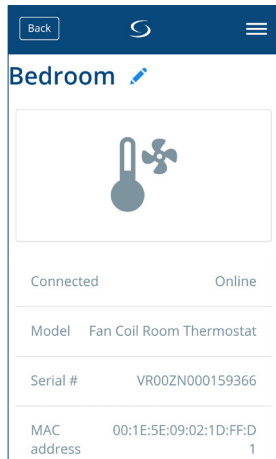

Access Settings. Scroll to the bottom of the screen.

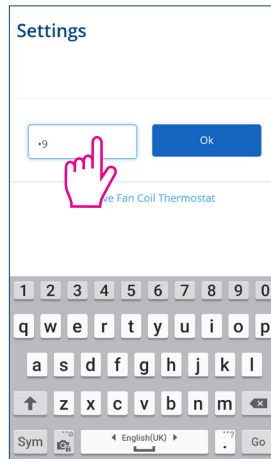

Enter password 49.



Tap **Ok**.

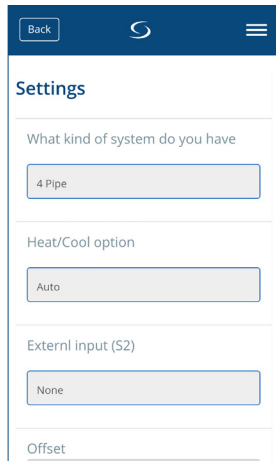



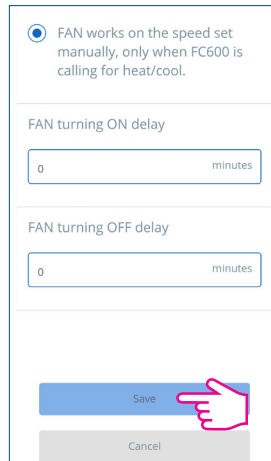

Scroll down to see all the settings available.



To keep your changes, tap **Save**.

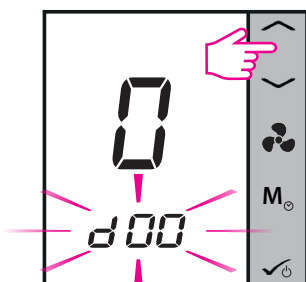

4.9. Full Parameter List

The installer parameters for the Fan Coil come in a list of dx names and for each dx parameter you can choose a specific value, that will set the Fan Coil to a specific setting. When you accessed Installer Settings, a short press of the  or  will switch to d01, d02, d03 etc and a short press of  will enter the setting. Use again  or  to modify the value for the parameter.



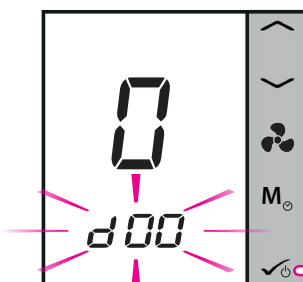

The d00 will flash. Choose parameter using  or .

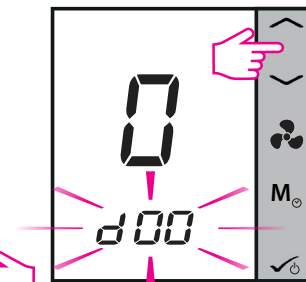

Press OK  to enter parameter and then press OK  again to exit parameter.



The d00 will flash. Choose parameter using  or .

Note: During the installer mode, if no any button pressed, then FC600 should save the changes and go to main menu in 15minutes.

Parameter number	Type of setting	Description	Default Values
d00	Type of thermostat	0 = Non-programmable - you cannot set schedules to your thermostat. It can operate only in local mode 1 = Programmable - you can set schedules to your thermostat	0
d01	Fancoil type 2 or 4 pipes	0 = 2 pipes 1 = 4 pipes	0
d02	S1/COM Terminal	<p>0 = Manual - The user can change between Heating/Cooling Modes only manually by pressing the Mode button</p> <p>1 = Heat/Cool changeover (HCCO) - the selection between heating and cooling is made via the external switch. User cannot select heating/cooling mode by pressing the Mode button. When S1/COM contact is open = Heat mode S1/COM contact is close = Cool mode</p> <p>2 = Auto Heat/Cool Changeover - the switching between heating and cooling is performed automatically. User cannot select heating/cooling mode by pressing the Mode button. <u>In a 2 pipe system</u> Procedure performed by the pipe sensor . When the temperature on the pipe is low = cool mode When the temperature on the pipe is high = heat mode. The switching set point between heating and cooling is determined by the d24 and d25 parameters. <u>In a 4 pipe system</u> The Heat/Cool changeover is performed automatically by the internal sensor, using the function called "dead zone".</p> <p>3 = Auto Sens (for 2 pipes only). The function is available only if there is a pipe sensor connected to the S1/com terminal. The function will turn FAN OFF if pipe sensor's temperature is \leq d25 in heat mode or if the pipe sensor's temperature is \geq d24 in cool mode. User cannot select heating/cooling mode by pressing the Mode button.</p>	0

Parameter number	Type of setting	Description	Default Values
d03	S2/COM terminals	0 = no function - ECO mode available via "Mode" button 1 = door - ECO mode (or STANDBY) is activated via external free-volt switch: - terminal S2/COM is open - normal mode - terminal S2/COM is closed - ECO (STANDBY) mode 2 = SenS - external temperature sensor is connected. Internal sensor is inactive - thermostat displays temperature from external sensor.	0
d04	Heat and Cool mode selection - This parameter is available only when d01 = 0 (2 pipe) and d02 = 0 or 2 (S1-COM no function, or pipe sensor connected)	0 = Heating & Cooling available using MODE button 1 = Cooling ONLY (user can't change mode using MODE button) 2 = Heating ONLY (user can't change mode using MODE button)	1
d05	Offset	This functions allows you to calibrate your displayed temperature value. It can be adjusted from -3.0 °C to +3.0 °C	0 °C
d06	Max heating setpoint	From 5 °C to 40 °C	40 °C
d07	Min heating setpoint	From 5 °C to 40 °C	5 °C
d08	Max cooling setpoint temperature	From 5 °C to 40 °C	40 °C
d09	Min cooling setpoint temperature	From 5 °C to 40 °C	5 °C
d10	ECO set point in Heating mode	This setting is responsible for the ECO setpoint temperature when the thermostat is in Heating mode. Can be set to any value from 5 °C to 40 °C.	15 °C
d11	ECO set point in Cooling mode	This setting is responsible for the ECO setpoint temperature when the thermostat is in Cooling mode. Can be set to any value from 5 °C to 40 °C.	30 °C
d12	Time zone	From -13 to +13	+1
d13	DST – Day light saving time	0 = Enabled 1 = Disabled	0
d14	Key lock function	Use this function to enable/disable auto keylock function. 0 = manual - the user can lock the keys manually via device or App. 1 = Auto (thermostat will lock the keys after 5 minutes since last button press) 2 = Unlocked the user can't lock the keys.	0

Parameter number	Type of setting	Description	Default Values
d15	TPI/Span control	<p>0 = TPI 1 = Span control</p> <p>TPI - (Time Proportional and Integral algorithm) - fan and valve control method, designed to provide the best energy efficiency. This algorithm not only determines the speed of the fan (depending on the difference between the room temperature and the set temperature) but also adapts its work according to repetitive home / office temperature conditions to effectively and economically manage the energy.</p> <p>Span - room temperature control method to achieve setpoint temperature in the fastest possible way by changing the gears of the fan. With a large temperature difference (between the setpoint and measured), the fan operates at maximum speed. The closer to the setpoint, the lower the fan speed.</p>	0
d16	Set the control type in modulation. This parameter is available only if we select TPI algorithm, not SPAN	<p>0 = Slow change environment 1 = Fast change environment</p>	0
d17	Set the Span control for heating mode respectively	<p>The range of span is 1 to 20 (0.1K to 2.0K) Mean: 1=0.1K...20=2.0K</p>	0.3K(This parameter is ignored if TPI control is selected)
d18	Set the Span control for cooling mode respectively	<p>The range of span is 1 to 20 (0.1K to 2.0K) Mean: 1=0.1K...20=2.0K</p>	0.5K (This parameter is ignored if TPI control is selected)
d19	Set the minimum turn off time for heating mode respectively	10 to 300 seconds	10
d20	Set the minimum turn off time for cooling mode respectively	10 to 300 seconds	10
d21	TPI heat control CPH	3 – 12 on/off cycle per hour	6
d22	TPI cool control CPH	3 – 12 on/off cycle per hour	3
d23	Dead zone Comfort mode (4 pipe only)	1.0 to 5.0K	2.0

Parameter number	Type of setting	Description	Default Values
d24	Heat/cool changeover cooling switch-point Heat/cool changeover cooling switch-point Heat/cool changeover cooling switch-point	The value of this parameter is used by the pipe temperature sensor to switch to Heating mode. When the temperature acquired by the sensor is above this parameter's value, the thermostat will switch to heating mode.	10°C
d25	Heat/cool changeover heating switch-point	The value of this parameter is used by the pipe temperature sensor to switch to Cooling mode. When the temperature acquired by the sensor is below this parameter's value, the thermostat will switch to cooling mode.	30°C
d26	S1 - COM input position	0 = Normally open 1 = Normally close	0
d27	S2 - COM input position	0 = Normally open 1 = Normally close	0
d28	Service filter	The 'clean fan filter reminder' function counts the fan operating hours. Is OFF or from 0.1 to 9.9 (9.9 means 9900hrs = 9.9*100)	Off
d29	Protection heating set point	OFF or from 5°C to 40°C (d29 value can not higher than d30)	8
d30	Protection cooling set point	OFF or from 5°C to 40°C	Off
d31	Temperature display resolution	This setting allows you change the temperature display resolution. 0 = 0.1°C 1 = 0.5°C	1
d32	Cooling start delay	From 0 to 15 minutes	0
d33	Clock format	0 = 12h 1 = 24h	1
d34	ECO mode or STANDBY mode. When S2/COM terminals are short – thermostat will go to ECO mode or STANDBY mode.	0 = ECO mode 1 = STANDBY mode For example when hotel card is in (occupancy sensor indicates that person is in the room) – the thermostat will go to ECO mode if you select "0", or go to STANDBY model if you select "1"(for details, please see below)	0
d35	OFFSET of the second sensor connected do S2/COM (parameter available only when d03 = 2)	From -3°C to +3°C	0°C

Parameter number	Type of setting	Description	Default Values
d36	Status after power breakdown	After the power is on, the thermostat will function in 0 = standby 1 = last configuration	0
d37	To allow user unlock the keys or NOT	1 = means user can unlock by pressing and 0 = means user can NOT unlock by pressing and If d37=0, user can lock/unlock the keys, only through the App.	0
d38	Manual Fan Speed Operation	0 = Fan always on (doesn't matter if the Fan Coil is calling or not for heating or cooling) 1 = FAN works on the speed set manually, only when the Fan Coil is calling for heating or cool	1
d39	FAN turning ON delay	0 seconds to 30 minutes	0
d40	FAN turning OFF delay	0 seconds to 30 minutes	0
d41	Valve control when FAN is manually OFF	0 – (default) no valve control when fan is MANUALLY off 1 – still use valve control when fan is MANUALLY off	

Note: Setting d00, d01, d02, d03,d04 cannot be changed in Installer menu, neither on the device or on the app. They depend on your initial setup and on the configuration of your system and can be changed only when you will reinstall/make changes to you fancoil or system. Some parameter will be visible/invisible in depend of the MAIN parameters setting (d01,d02,d03,d04, programmable, non-programmable).

4.10. Fan and valve operation (V1) including pipe sensor in a 2-pipe system with the use of "d24" and "d25" parameters

4.10.1. Fan operation in heating and cooling mode

The following diagram explains the principle of switching between heating and cooling as well as the operating conditions for the fan and valve (V1):

I stage - Valve V1 opens, the thermostat works in cooling mode. The temperature of the pipe increases to the value from parameter "d24" + 2 °C and at this moment it turns off the fan.

Stage II - Valve V1 opens, the temperature of the pipe increases to the value from parameter "d25", the thermostat switches from cooling to heating. Then the fan gets permission to work.

Stage III - Valve V1 opens, the thermostat works in heating mode. The temperature of the pipe drops to the value from parameter "d25" - 2 °C, and at this moment it turns off the fan.

IV stage - Valve V1 opens, the temperature of the pipe drops to the value from parameter "d24", the thermostat switches from heating to cooling. Then the fan gets permission to work.

V stage - Valve V1 opens, the thermostat works in cooling mode. The temperature of the pipe increases to the value from the parameter "d24" + 2 °C and at this moment it turns off the fan (this is the same as stage I)

Stage VI - the same as stage II

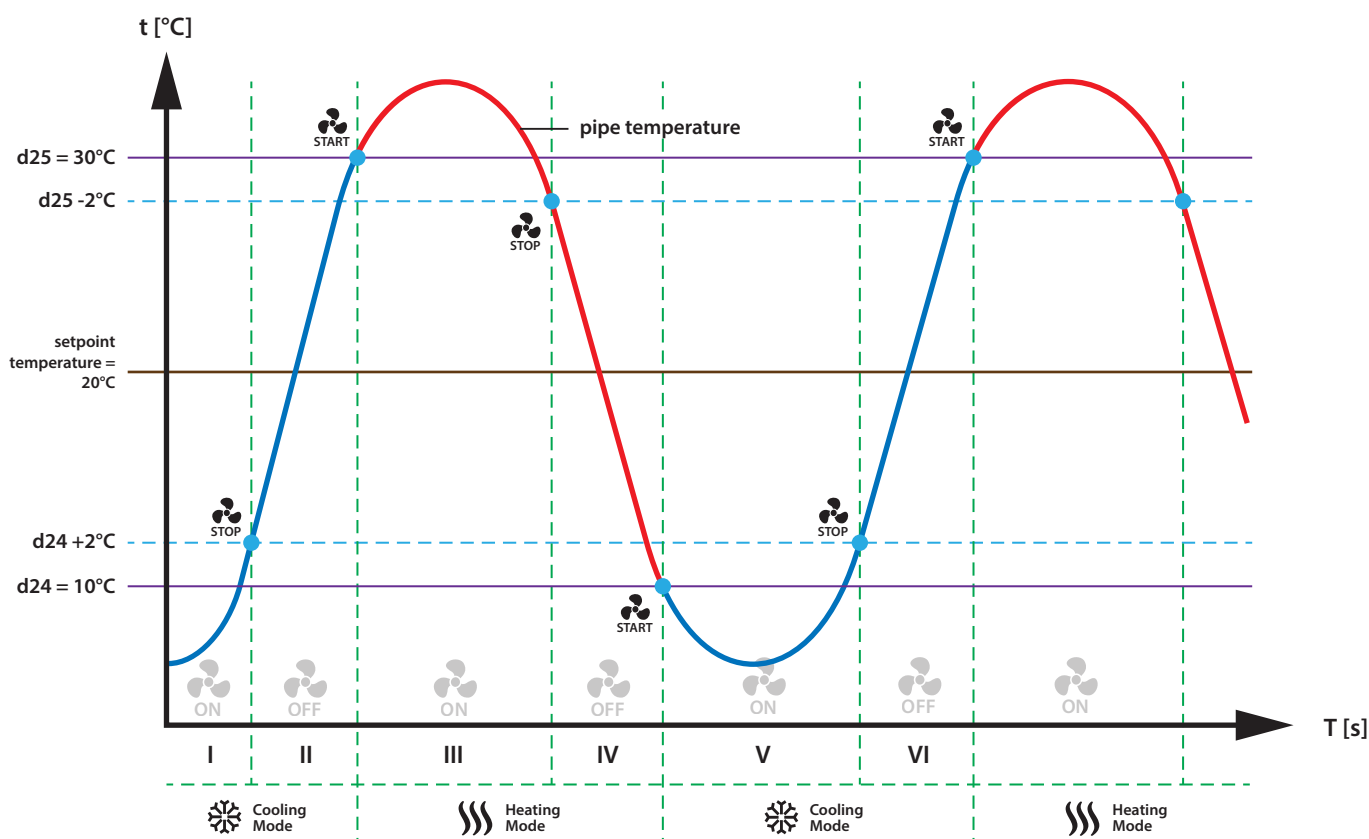

4.10.2. Fan operation in cooling mode

If FC600 is in cooling mode and has the task of cooling the room, the valve V1 opens. The fan will start only when the pipe reaches the temperature below the "d24" value. If the temperature of the pipe will increase by 2°C above the parameter "d24", the fan will be switched off and the valve will still be open. FC600 waits until temperature of the pipe will drop below the "d24" parameter and only then starts the fan. This is useful if FC600 controls the water fan coils (coolers), which are not to be operated in the winter.

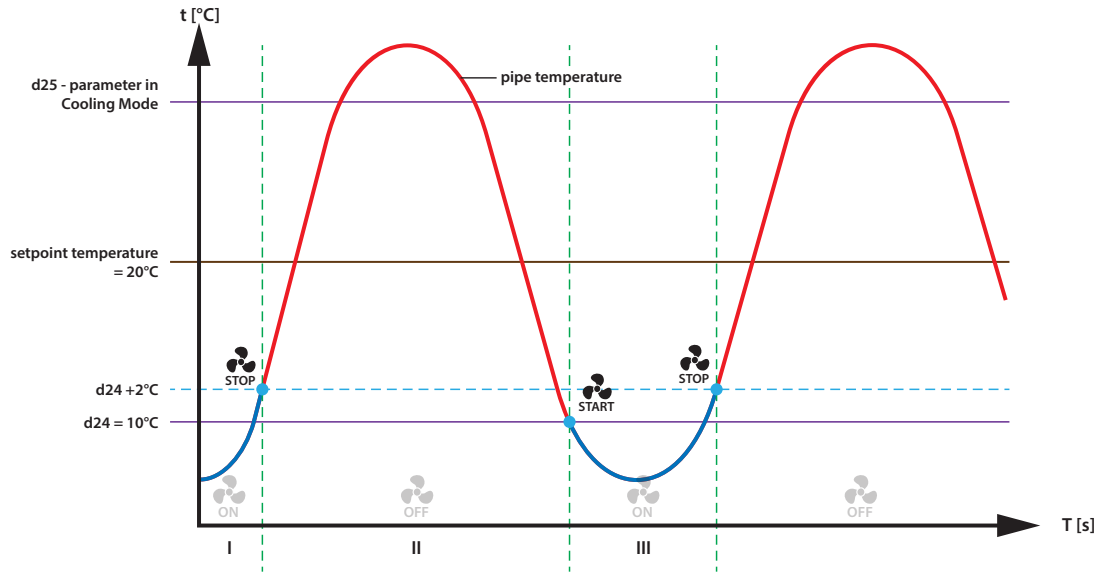

4.10.3. Fan operation in heating mode

If FC600 is in heating mode and has the task of heating the room, the valve V1 opens. The fan will start only when the pipe reaches the temperature of the higher value of the parameter "d25". If the temperature of the pipe drops below 2°C below parameter "d25", the fan will be switched off and the valve will still be open. FC600 expects an upward mode (above parameter "d25") and only then starts the fan. Such a solution is helpful if the regulator controls the water fan coils (heaters), which are not to be operated in the summer.

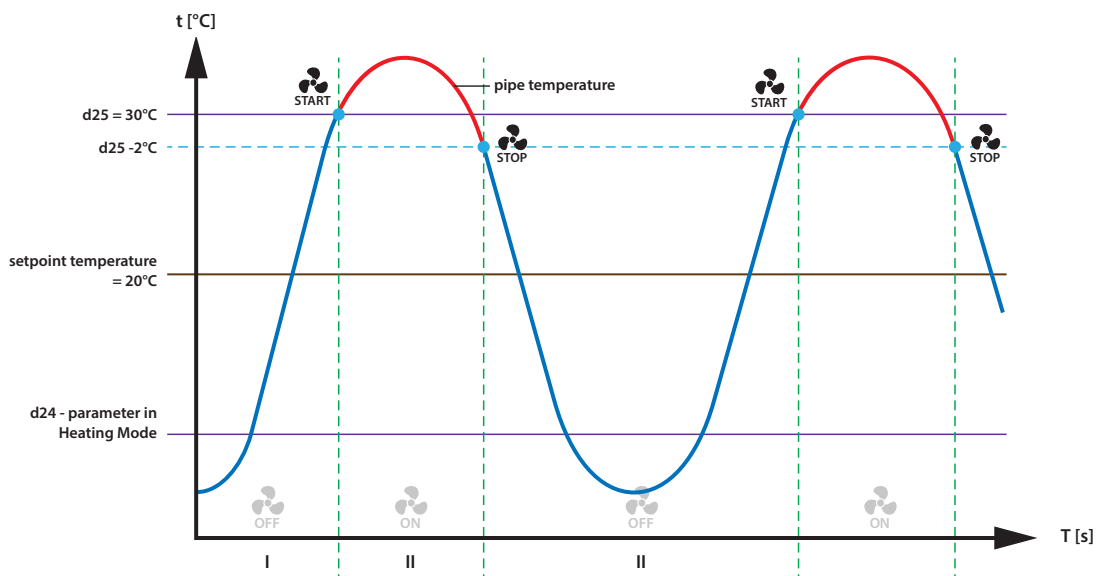

Note: When the pipe temperature is too low (in heating mode) or too high (in cooling mode) - the sensor icon and digit "1" will flash on the LCD. When the pipe temperature is right, fan will start-up and the icons on the LCD will be permanently lit (it will not blink).

4.11. Switching from offline to online mode

If you want to add the FC to the UGE600 after you set it up, you need to use the 55 code, and then you select UG YES, and then you confirm PAIR to start joining the UG. On the App you should see all the settings which have been already done in the past, when you configured the FC600 without the UG. Please see the detailed procedure as shown. Make sure your UG is connected to the system and you have the App installed.



To begin the pairing process the gateway should be plugged into the power source and connected to the Internet. Also, make sure that the UG is added to your Salus Smart Home App. For the installation of the Universal Gateway, please refer to the UG600/UGE600 manual on salus-manuals.com



Make sure that your Universal Gateway is added to the App. The led of the Gateway should be steady blue. Once you have that installed, go to your Fan Coil and begin pairing it with the UG and adding it to the App.

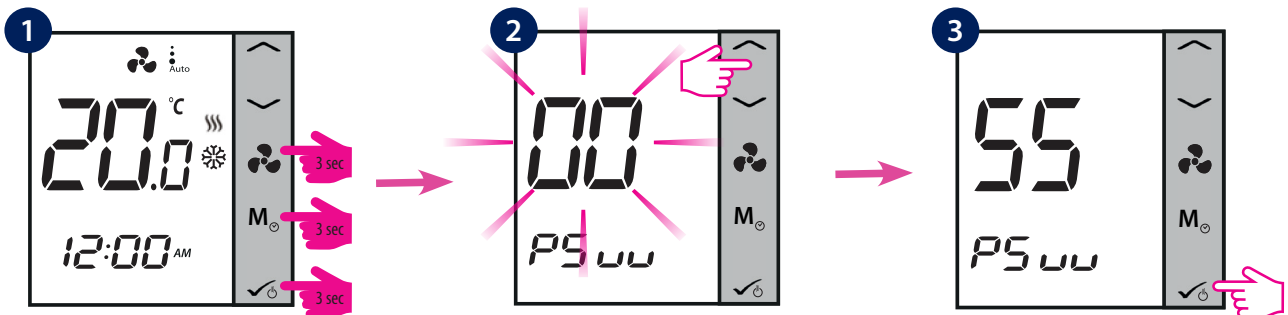

Press the buttons for 3 seconds.

The digits on the screen will flash. Using \wedge or \vee , enter pass 55.

Press OK \checkmark .

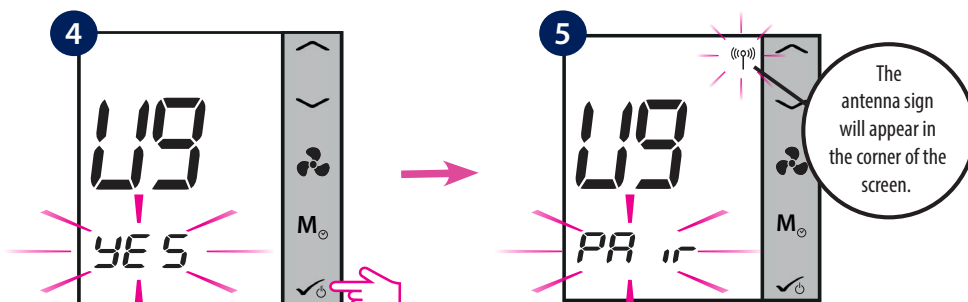

Press OK \checkmark .

At this point you should go to the App in order to configure your Fan Coil.

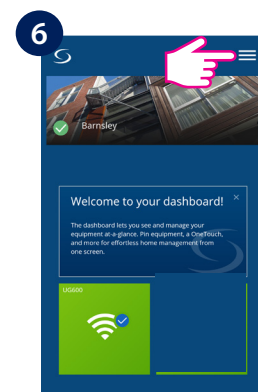

Now go to the App. Tap menu icon \equiv .

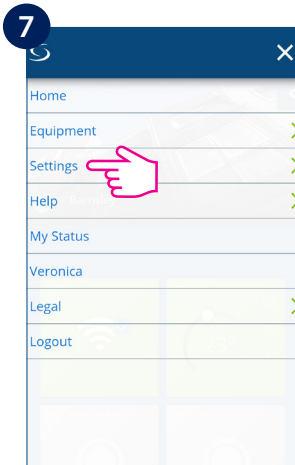

Tap **Settings**.

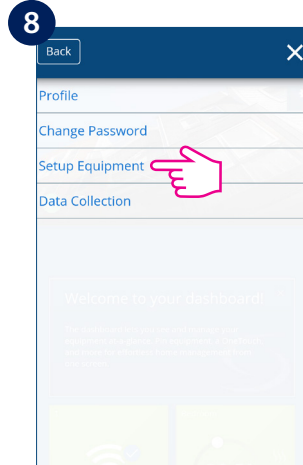

Tap **Setup Equipment**.

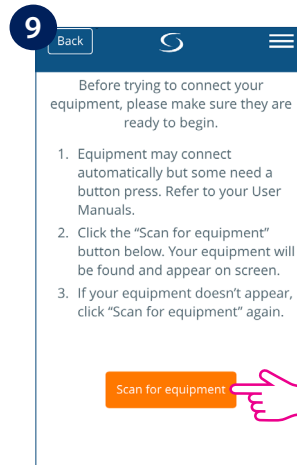

Tap **Scan for equipment**.



When new equipment is being added, the UG should flash red.

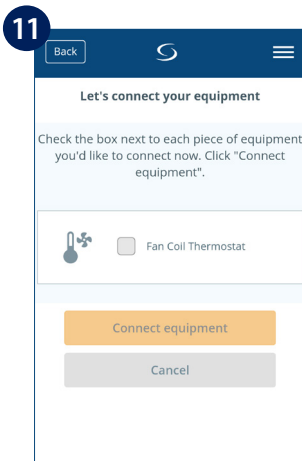

The Fan Coil should appear on screen.

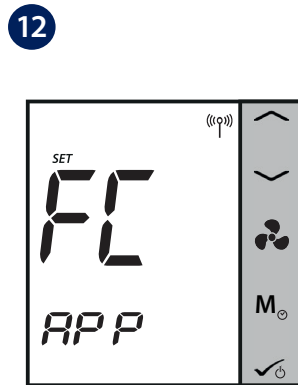

The Fan Coil will go automatically into FC App screen.

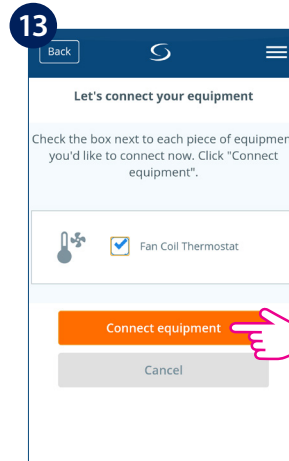

Select device and tap **Connect equipment**.

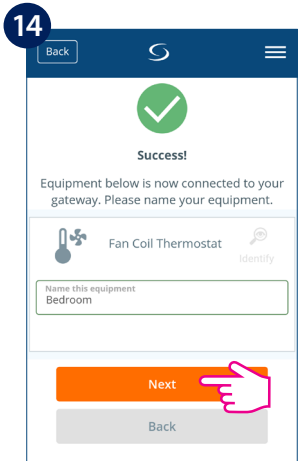

Rename your device and tap **Next**.

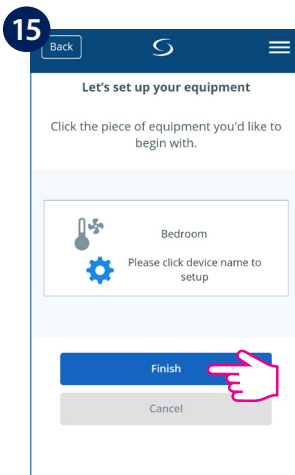

Now, tap **Finish** to complete the setup.

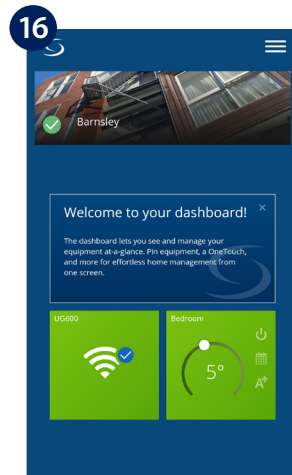

The thermostat tile appears on the dashboard.

4.12. Reset Function

If you want to reset your device, please follow the steps below. Note that when you reset your device, all your settings will be lost and you will have to start all from the beginning.

4.12.1. In Local Mode (without Internet connection)

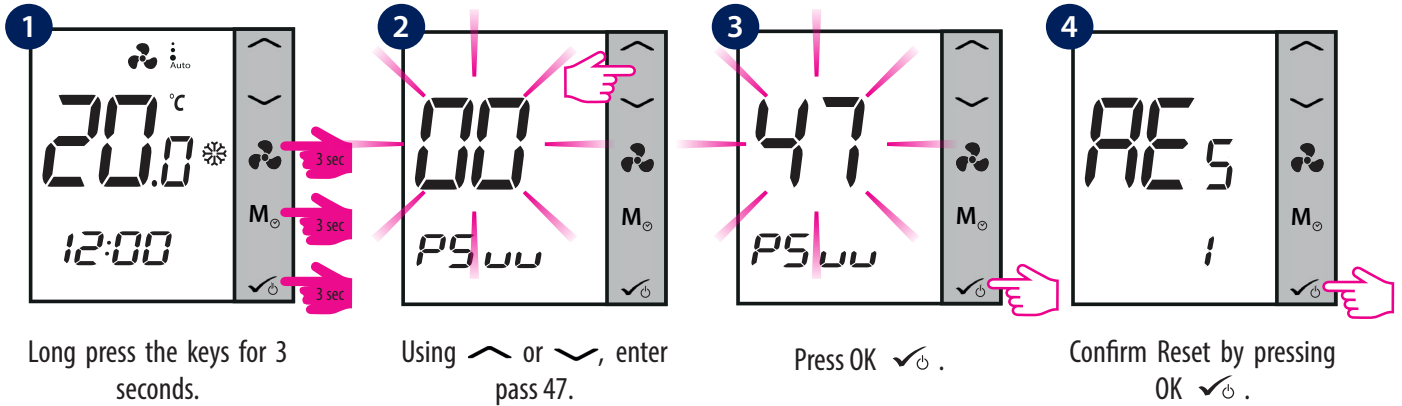

4.12.2. Via App

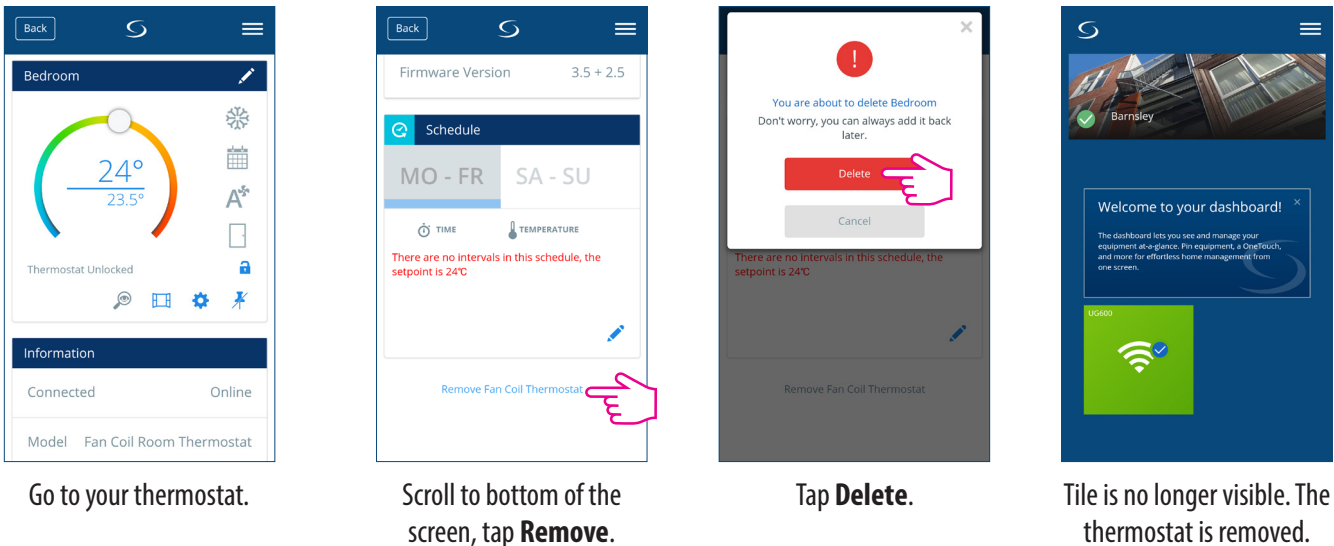

Note: If you reset your thermostat on your device, but it was connected to the App, the thermostat tile on the dashboard will go dark gray and it will mean that the device is not connected to the cloud. You will not be able to operate any changes to it. An alert screen sign  will appear on your screen. If you tap it, it will tell that the Fan Coil left the system.

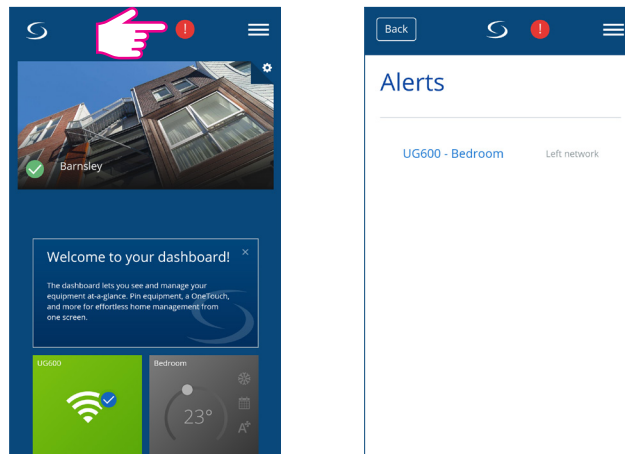

4.13. Cleaning and Maintenance

The FC600 Fan Coil requires no special maintenance. Periodically, the outer casing can be wiped clean using a dry cloth (please DO NOT use solvents, polishes, detergents or abrasive cleaners, as these can damage the thermostat). There are no user serviceable parts within the unit; any servicing or repairs could only be carried out by Salus Controls or their appointed agents.

4.14. Technical Specification

Product Specification	
Model:	FC600
AC power supply	230Vac +10% -15% 50Hz
Temperature Sensing specifications	
Temperature Sensors	Air sensor (indoor) + External-sensor (optional)
Unit of temperature measurement	°C
Indoor temp sensor measuring range	0°C –45°C
Indoor temp sensor display range	0°C –45°C
Indoor temp display resolution	0.5°C or 0.1°C (selectable)
Indoor temp set point range	5°C - 40°C
Indoor Temperature accuracy offset range	From -3,0 to +3,0 in 0,5 steps
Frost protection point	Yes
Overheat protection	Yes
Temperature sampling duration	Every 15 seconds
Multifunctional input S1-M/S2-M	
Temperature sensor input Type	NTC 10 kOhm B 25/50 = 3950K, R 25 = 10.000KOhm
Temperature range	0...50°C
Clock display format	12 / 24 hour format
Program Setting	
Program	5+2 / 7 individual days / all 7 days same
Temporary & Permanent Override	Yes
Memory	
Non-volatile memory	MCU flash store clock and all user settings
Backup power during power blackout	The ideal position to locate the RT310 thermostat is about 1.5m above floor level, in a location where the thermostat is accessible, reasonably lit and free from extremes of temperature and draughts. Do not mount the thermostat on an outside wall, above a radiator or in a location where it may be subjected to direct sunlight.p to 17hrs
Dust and water proof level	IP30
Operating environment	
Operating temperature	0°C - 50°C
Storage temperature	-25°C - 60°C
Relative humidity (non-condensed)	<95% r.h.

4.15. Warranty

SALUS Controls warrants that this product will be free from any defect in materials or workmanship, and shall perform in accordance with its specification, for a period of two years from the date of installation. SALUS Controls sole liability for breach of this warranty will be (at its option) to repair or replace the defective product.

Customer Name:

Customer Address:

..... **Post Code:**

Tel No: **Email:**

Company Name:

Tel No: **Email:**

Installation Date:

Installer Name:

Installer Signature:

NOTES

A series of horizontal dotted lines for taking notes.

SALUS Controls PLC
SALUS House

Dodworth Business Park South,
Whinby Road, Dodworth,
Barnsley S75 3SP, UK.

Sales:

T: +44 (0) 1226 323961

E: sales@salus-tech.com

Technical:

T: +44 (0) 1226 323961

E: tech@salus-tech.com



www.salus-controls.com

SALUS Controls is a member of the Computime Group.

Maintaining a policy of continuous product development SALUS Controls plc reserve the right to change specification, design and materials of products listed in this brochure without prior notice.

For the latest PDF Instruction Manual, go to www.salus-manuals.com

Issue Date: April 2019
V014

