

TT3000 – TT3000C – TT3002



Function

Thermostatic valves allow to make each room independent with a specific set temperature, thus enhancing comfort and actual energy saving, as prescribed by national and international regulations.

The sensor inside the head regulates the opening and closing of the valve by reacting proportionally to temperature changes, thus allowing for room temperature adjustment.

It is vitally important not to install thermostatic heads under barriers such as shelves, curtains and pieces of furniture, or in a vertical position. These obstacles can store heat and thus distort the detection of room temperature.

Technical data

| | |
|--------------------------------------|---|
| Max. working pressure: | 10 bar |
| Max. differential pressure: | 1 bar |
| Max. working temperature: | 120 °C |
| Min. adjustment temperature: | 6 °C |
| Max. adjustment temperature: | 30 °C (TT3000, TT3000C), 28 °C (TT3002) |
| Energy saving conditions: | Pos. "3" = 20 °C |
| Working fluids: | Water in compliance with UNI 8065:1989 |
| Hysteresis (C): | < 0.4 K |
| Differential pressure influence (D): | 0.5 K |
| Response time (Z): | 22 min. |
| Water temperature influence (W): | 0.25 K |
| Inalterability range: | -15 °C ÷ +60 °C |
| Storage temperature: | -20 °C ÷ +50 °C |

Materials

| | |
|---------|---|
| Sensor: | Liquid |
| Head: | RAL9016 white ABS (TT3000, TT3002), chrome-plated ABS (TT3000C) |
| Collar: | CW 614 N UNI-EN 12164-2016 |

Dimensional Drawings

TT 3000

Thermostatic head with integrated control and sensor.

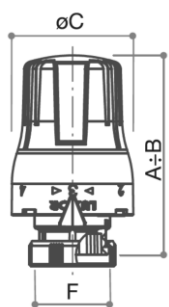

| Code | Size | A | B | C | E | F |
|----------|-----------|----|----|------|---|---------|
| 69100000 | M30 x 1,5 | 75 | 80 | 46,5 | - | M30x1,5 |

| Code | Size | A | B | C | E | F |
|--------------|-----------|----|----|------|---|---------|
| 69100000BRA* | M30 x 1,5 | 75 | 80 | 46,5 | - | M30x1,5 |

*With Braille numbers

TT 3000C

Thermostatic head with integrated control and sensor.

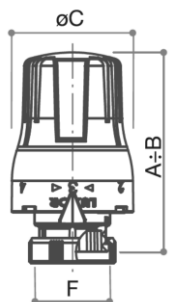

| Code | Size | A | B | C | E | F |
|----------|-----------|----|----|------|---|---------|
| 69100000 | M30 x 1,5 | 75 | 80 | 46,5 | - | M30x1,5 |

TT 3002

Thermostatic head with integrated control and remote sensor.
Standard length of capillary 2 m.

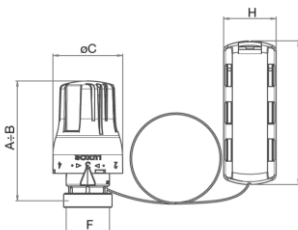

| Code | Size | A | B | C | E | F |
|----------|-----------|----|----|------|---|---------|
| 69100020 | M30 x 1,5 | 75 | 80 | 46,5 | - | M30x1,5 |

| Code | Size | G | H | L | M | N |
|----------|-----------|---|----|----|---|---|
| 69100020 | M30 x 1,5 | - | 35 | 96 | - | - |

BT 242

Tamper-and-theft-proof clip for TT 3000 and TT 3002.

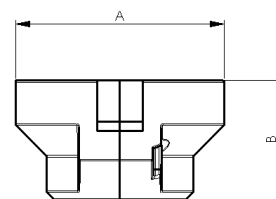

| Code | Size | A | B | C | D | E |
|----------|------|------|------|---|---|---|
| 69010402 | - | 50,5 | 28,5 | - | - | - |

Approvals



The TT 3000 thermostatic head complies with the European Standard EN215:2004/A1/2006. TT 3000 thermostatic heads is certified in combination with the following thermostatic valves: RS202 DN15; RS206 DN15; RS212 DN10; RS212 DN15; RS209 DN10; RS209 DN15; RS212/A DN10; RS212/A DN15; RS209/A DN10; RS209/A DN15; RS2502 DN15; RS2506 DN15; RS2512 DN10; RS2512 DN15; RS2509 DN10; RS2509 DN15; RS2512/A DN10; RS2512/A DN15; RS2509/A DN10; RS2509/A DN15.

The TT 3000 thermostatic head is classified as a “low thermal inertia” device and therefore complies with the requirements set out in the Italian Decreto del Ministero dell’Economia e delle Finanze del 19 febbraio 2007, “Disposizioni in materia di detrazioni per le spese di riqualificazione energetica del patrimonio edilizio esistente, ai sensi dell’art. 1, comma 349, legge 27/12/2006, n. 296”.

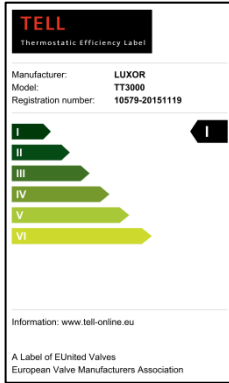

The TT3000 thermostatic head has obtained the Class I Thermostatic Efficiency Label (TELL).

Design and Function

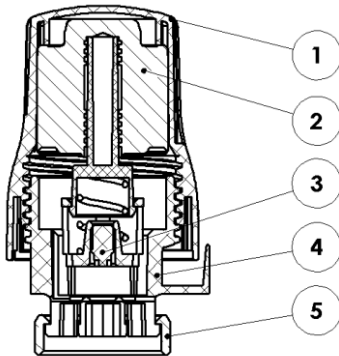

1. Adjustment knob
2. Liquid sensor
3. Piston
4. Body
5. Fastening collar

The thermostatic head consists of a sensor (2) filled with a highly expandable liquid. This liquid, which is placed inside the adjustment knob (1), expands or contracts in proportion to room temperature changes, reacting even to the smallest variation. When the surrounding temperature increases, the element expands and acts on the obturator with an axial thrust movement (3), thus controlling the valve’s action. The flow of the heating medium can be adjusted by opening and closing the valve. When the temperature decreases, the opposite occurs thanks to the thrust generated by the return spring. Thermostatic heads precisely maintain the set room temperature. The required value is set by turning the adjustment knob, the numbers on it correspond to different temperatures.

Range of Adjustment

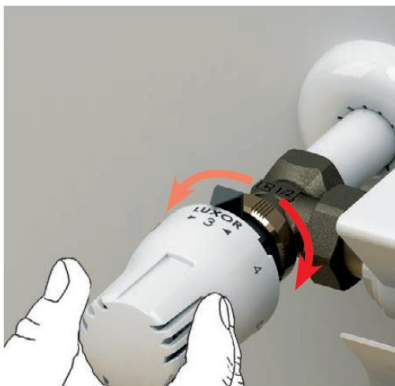

TT 3000 - TT 3000C

| | | | | | |
|------|-------|-------|-------|-------|-------|
| 6 °C | 12 °C | 16 °C | 20 °C | 24 °C | 30 °C |
| | | | | | |
| * | 1 | 2 | 3 | 4 | 5 |

TT 3002

| | | | | | |
|------|-------|-------|-------|-------|-------|
| 6 °C | 12 °C | 16 °C | 20 °C | 24 °C | 28 °C |
| | | | | | |
| * | 1 | 2 | 3 | 4 | 5 |

Working Instructions



Before installing the thermostatic head, set the adjustment knob to "5", so as to facilitate the following installation steps. Unscrew the RAL 9016 white ABS protection cap mounted on THERMOTEKNA thermostatic valves. Tighten the brass collar of the thermostatic head to the valve body, then set the knob to the desired position.

Conditions for a Proper Functioning



Fig.1



Fig.2



Fig.3



Fig.4



Fig.5



Fig.6

Thermostatic heads must be installed away from the heat streams surrounding the heating body (fig. 1) and direct sunlight (fig. 2).

Do not install thermostatic heads under shelves (fig. 3), in a recess (fig. 4), within the heat stream (fig. 5) or behind curtains (fig. 6).

These kinds of installation are not proper, as they may cause the head to measure temperature values which do not coincide with the actual room temperature.

In order for the system to function properly, it is advisable to install a pressure relief valve between the inlet and the outlet. To avoid excessive noise in the system it is recommended not to use thermostatic valves with ΔP value above 0,2-0,25 bar.

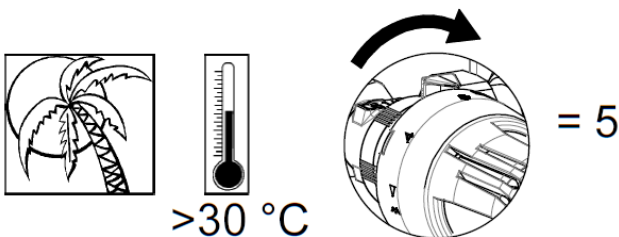

During summer it is recommended to set the heads to the maximum opening so as to avoid issues connected with an excessive force applied on the valves's screw in closed position.



TT3000 thermostatic heads can be applied to all heating bodies unless in presence of barriers such as shelves, curtains or furniture, which may accumulate heat and therefore alter the measurement of room temperature. In this case, it is recommended to use TT3002 thermostatic heads with remote sensor.

Placing and Installation of the TT 3002 sensor

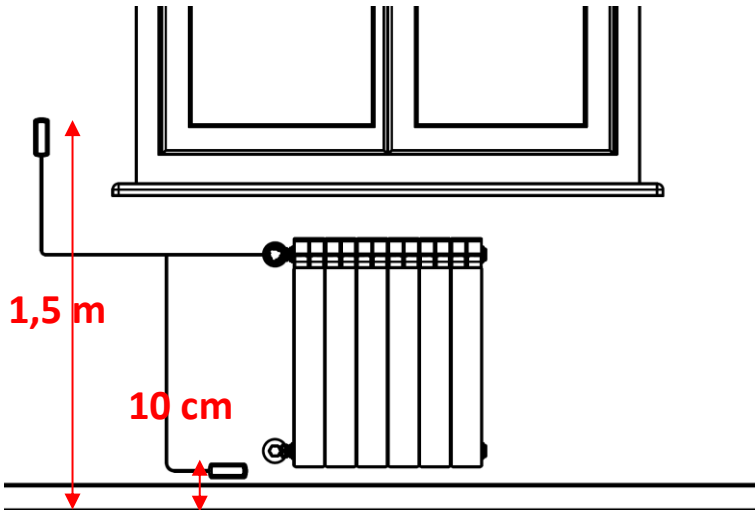

Place the sensor as shown in the picture.

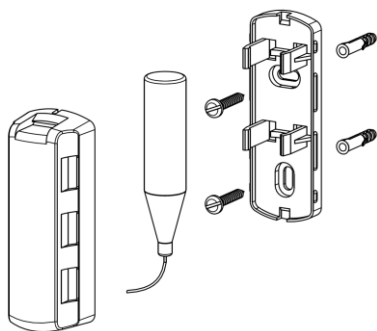

Fasten the sensor case with the included screws and dowels.

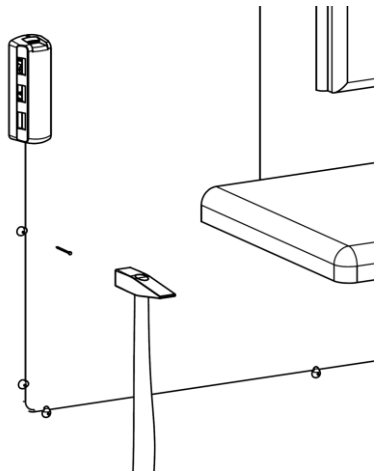

Fasten the capillary with the U-bolts and nails included in the package.

WARNING: Take care not to crush, pierce or tilt the capillary

Limiting and Blocking Temperature

The head's temperature range can be limited or locked by using the provided fork pin.

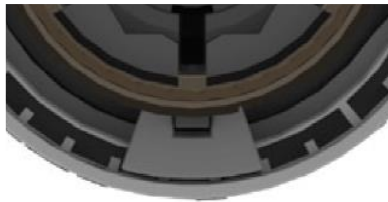

Blocking the adjustment

To lock the temperature to a fixed value, for example "3":

- turn the knob so that the indicator corresponds to the required position.
- Insert the fork pin across the spline placed in the lower part, diametrically opposite to the index.

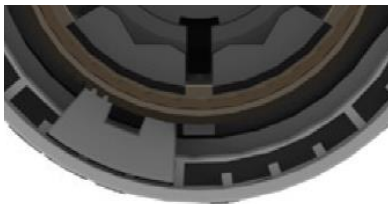

Limiting the temperature range

To limit the temperature range between a chosen value and a maximum limit, for example "3" and "5":

- Insert the fork pin to the left of the spline.

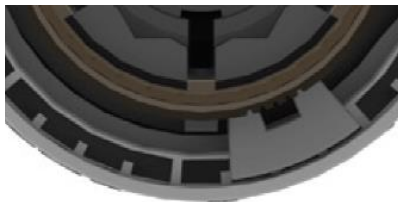
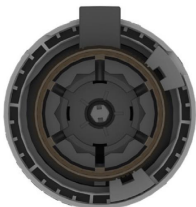

To limit the temperature range between a chosen value and a minimum limit, for example "3" and "❄":

- Insert the fork pin to the right of the spline.

Working Instructions BT 242

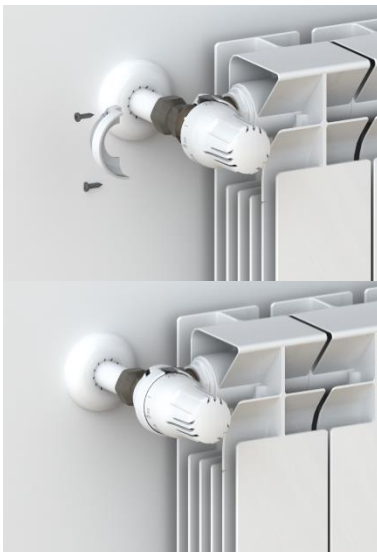

Tamper-and-theft-proof clip for TT 3000 and TT 3002.

The tamperproof and antitheft version of the thermostatic head is formed by fitting a suitable shell to the knob as shown in the illustration on the side.

It is secured with two screws with a special head and can therefore only be tightened with the appropriate allen key.

Item Specifications

TT 3000

Low thermal inertia thermostatic head with integrated control and sensor, liquid sensitive element. Graduated scale from “❄” to 5, corresponding to an adjustment range of 6°C to 30°C. Possibility to limit and lock the temperature.

TT 3002

Low thermal inertia thermostatic head with integrated control and remote sensor, liquid sensitive element. Graduated scale from “❄” to 5, corresponding to an adjustment range of 6°C to 30°C. Possibility to limit and lock the temperature.

TT 3000C

Low thermal inertia thermostatic head with integrated control and sensor, liquid sensitive element. Graduated scale from “❄” to 5, corresponding to an adjustment range of 6°C to 30°C. Possibility to limit and lock the temperature.

BT 242

Tamper-and-theft-proof clip for TT 3000 and TT 3002.



Luxor S.p.A.

Sede amministrativa, stabilimento e uffici commerciali:

Administrative office, factory and commercial office:

Tel.: 030-9961161 – Fax: 030-9961165

info@luxor.it – www.luxor.it

via Madonnina, 94 – 25018 Montichiari - (BS) Italy

*Luxor si riserva il diritto di apportare miglioramenti e modifiche ai prodotti descritti ed ai relativi dati tecnici in qualsiasi momento e senza preavviso -
Luxor reserves the right to ameliorate and modify the above products and their technical data at any time and without notice*

TEKNA

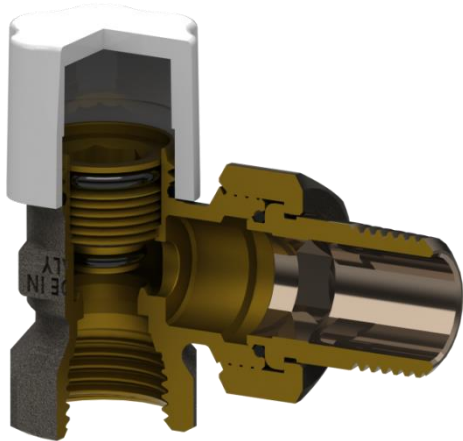

Function

TEKNA lockshield valves offer the best fluid dynamic characteristics. Their tightness is ensured by an O-ring and a flat gasket placed inside the plug. All lockshield valves may be adjusted by limiting the lift of the obturator.

Technical data

| | |
|-----------------------------|--|
| Max. working pressure: | 10 bar |
| Max. differential pressure: | 1 bar |
| Max. working temperature: | 120 °C |
| Working fluids: | Water in compliance with UNI 8065:1989 |

Materials

| | |
|-------------|---------------------------------|
| Valve body: | CW 617 N – DW UNI-EN 12165:2016 |
| Obturator: | CW 614 N – DW UNI-EN 12164:2016 |
| O-rings: | Peroxide cured EPDM |
| Plug: | RAL9016 white ABS |

Surface treatment

Nickel-plating

Dimensional Drawings

DD 21

Straight regulating lockshield.
Connection for iron pipe

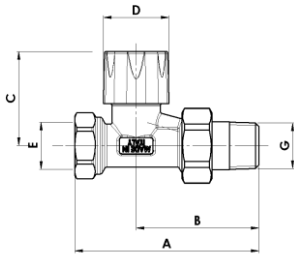

| Code | Size | A | B | C | D | E |
|----------|----------|----|----|----|----|------|
| 10261700 | DN10 3/8 | 76 | 51 | 41 | 30 | G3/8 |
| 10262100 | DN15 1/2 | 83 | 55 | 42 | 30 | G1/2 |
| 10262700 | DN20 3/4 | 97 | 65 | 43 | 30 | G3/4 |

| Code | Size | F | G | H | L | M |
|----------|----------|---|------|---|---|---|
| 10261700 | DN10 3/8 | - | R3/8 | - | - | - |
| 10262100 | DN15 1/2 | - | R1/2 | - | - | - |
| 10262700 | DN20 3/4 | - | R3/4 | - | - | - |

DS 22

Angle regulating lockshield.
Connection for iron pipe

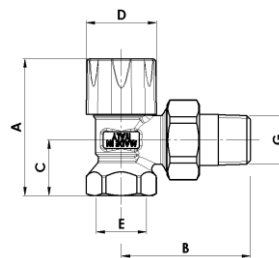

| Code | Size | A | B | C | D | E |
|----------|----------|----|----|----|----|------|
| 10061700 | DN10 3/8 | 53 | 50 | 20 | 30 | G3/8 |
| 10062100 | DN15 1/2 | 57 | 54 | 23 | 30 | G1/2 |
| 10062700 | DN20 3/4 | 57 | 62 | 27 | 30 | G3/4 |

| Code | Size | F | G | H | L | M |
|----------|----------|---|------|---|---|---|
| 10061700 | DN10 3/8 | - | R3/8 | - | - | - |
| 10062100 | DN15 1/2 | - | R1/2 | - | - | - |
| 10062700 | DN20 3/4 | - | R3/4 | - | - | - |

DD 25

Straight regulating lockshield with O-ring sealing.
Connection for iron pipe

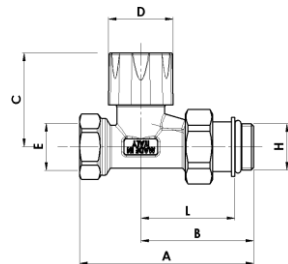

| Code | Size | A | B | C | D | E |
|----------|----------|----|----|----|----|------|
| 10262117 | DN10 3/8 | 73 | 48 | 41 | 30 | G3/8 |
| 10262103 | DN15 1/2 | 78 | 51 | 42 | 30 | G1/2 |
| 10262703 | DN20 3/4 | 95 | 63 | 43 | 30 | G3/4 |

| Code | Size | F | G | H | L | M |
|----------|----------|---|---|------|----|---|
| 10262117 | DN10 3/8 | - | - | G3/8 | 38 | - |
| 10262103 | DN15 1/2 | - | - | G1/2 | 40 | - |
| 10262703 | DN20 3/4 | - | - | G3/4 | 51 | - |

DS 26

Angle regulating lockshield with O-ring sealing.
Connection for iron pipe

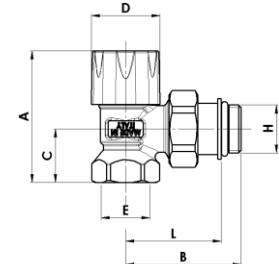

| Code | Size | A | B | C | D | E |
|----------|----------|----|----|----|----|------|
| 10062117 | DN10 3/8 | 53 | 47 | 20 | 30 | G3/8 |
| 10062103 | DN15 1/2 | 57 | 50 | 23 | 30 | G1/2 |
| 10062703 | DN20 3/4 | 57 | 57 | 27 | 30 | G3/4 |

| Code | Size | F | G | H | L | M |
|----------|----------|---|---|------|----|---|
| 10062117 | DN10 3/8 | - | - | G3/8 | 37 | - |
| 10062103 | DN15 1/2 | - | - | G1/2 | 39 | - |
| 10062703 | DN20 3/4 | - | - | G3/4 | 45 | - |

DD 31

Straight regulating lockshield.
Connection for copper and plastic pipe W24x19"

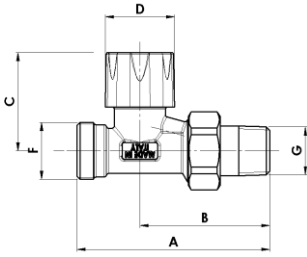

| Code | Size | A | B | C | D | E |
|------|------|---|---|---|---|---|
|------|------|---|---|---|---|---|

| | | | | | | |
|----------|----------|----|----|----|----|---|
| 10361700 | DN10 3/8 | 76 | 51 | 41 | 30 | - |
|----------|----------|----|----|----|----|---|

| | | | | | | |
|----------|----------|----|----|----|----|---|
| 10362100 | DN15 1/2 | 82 | 55 | 42 | 30 | - |
|----------|----------|----|----|----|----|---|

| Code | Size | F | G | H | L | M |
|------|------|---|---|---|---|---|
|------|------|---|---|---|---|---|

| | | | | | | |
|----------|----------|--------|------|---|---|---|
| 10361700 | DN10 3/8 | W24x19 | R3/8 | - | - | - |
|----------|----------|--------|------|---|---|---|

| | | | | | | |
|----------|----------|--------|------|---|---|---|
| 10362100 | DN15 1/2 | W24x19 | R1/2 | - | - | - |
|----------|----------|--------|------|---|---|---|

DS 32

Angle regulating lockshield.
Connection for copper and plastic pipe W24x19"

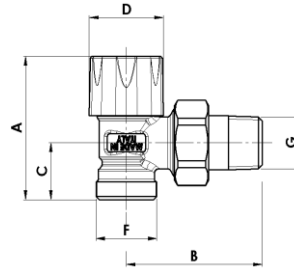

| Code | Size | A | B | C | D | E |
|------|------|---|---|---|---|---|
|------|------|---|---|---|---|---|

| | | | | | | |
|----------|----------|----|----|----|----|---|
| 10161700 | DN10 3/8 | 52 | 50 | 19 | 30 | - |
|----------|----------|----|----|----|----|---|

| | | | | | | |
|----------|----------|----|----|----|----|---|
| 10162100 | DN15 1/2 | 56 | 54 | 22 | 30 | - |
|----------|----------|----|----|----|----|---|

| Code | Size | F | G | H | L | M |
|------|------|---|---|---|---|---|
|------|------|---|---|---|---|---|

| | | | | | | |
|----------|----------|--------|------|---|---|---|
| 10161700 | DN10 3/8 | W24x19 | R3/8 | - | - | - |
|----------|----------|--------|------|---|---|---|

| | | | | | | |
|----------|----------|--------|------|---|---|---|
| 10162100 | DN15 1/2 | W24x19 | R1/2 | - | - | - |
|----------|----------|--------|------|---|---|---|

DD 38

Straight regulating lockshield with O-ring sealing.
Connection for copper and plastic pipe W24x19"

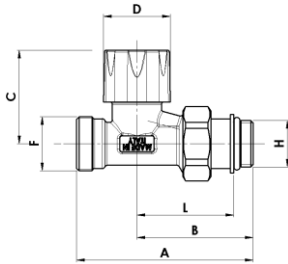

| Code | Size | A | B | C | D | E |
|------|------|---|---|---|---|---|
|------|------|---|---|---|---|---|

| | | | | | | |
|----------|----------|----|----|----|----|---|
| 10362117 | DN10 3/8 | 73 | 48 | 41 | 30 | - |
|----------|----------|----|----|----|----|---|

| | | | | | | |
|----------|----------|----|----|----|----|---|
| 10362103 | DN15 1/2 | 77 | 51 | 42 | 30 | - |
|----------|----------|----|----|----|----|---|

| Code | Size | F | G | H | L | M |
|------|------|---|---|---|---|---|
|------|------|---|---|---|---|---|

| | | | | | | |
|----------|----------|--------|---|------|----|---|
| 10362117 | DN10 3/8 | W24x19 | - | G3/8 | 38 | - |
|----------|----------|--------|---|------|----|---|

| | | | | | | |
|----------|----------|--------|---|------|----|---|
| 10362103 | DN15 1/2 | W24x19 | - | G1/2 | 40 | - |
|----------|----------|--------|---|------|----|---|

DS 39

Angle regulating lockshield with O-ring sealing.
Connection for copper and plastic pipe W24x19"

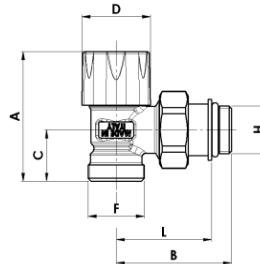

| Code | Size | A | B | C | D | E |
|------|------|---|---|---|---|---|
|------|------|---|---|---|---|---|

| | | | | | | |
|----------|----------|----|----|----|----|---|
| 10162117 | DN10 3/8 | 52 | 47 | 19 | 30 | - |
|----------|----------|----|----|----|----|---|

| | | | | | | |
|----------|----------|----|----|----|----|---|
| 10162103 | DN15 1/2 | 56 | 49 | 22 | 30 | - |
|----------|----------|----|----|----|----|---|

| Code | Size | F | G | H | L | M |
|------|------|---|---|---|---|---|
|------|------|---|---|---|---|---|

| | | | | | | |
|----------|----------|--------|---|------|----|---|
| 10162117 | DN10 3/8 | W24x19 | - | G3/8 | 37 | - |
|----------|----------|--------|---|------|----|---|

| | | | | | | |
|----------|----------|--------|---|------|----|---|
| 10162103 | DN15 1/2 | W24x19 | - | G1/2 | 39 | - |
|----------|----------|--------|---|------|----|---|

DD 31/A

Straight regulating lockshield.
Connection for copper and plastic pipe G3/4 Eurokonus

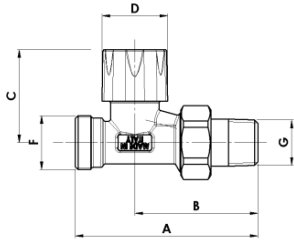

| Code | Size | A | B | C | D | E |
|----------|----------|----|----|----|----|---|
| 10362719 | DN10 3/8 | 76 | 51 | 41 | 30 | - |
| 10362722 | DN15 1/2 | 82 | 55 | 42 | 30 | - |

| Code | Size | F | G | H | L | M |
|----------|----------|--------|------|---|---|---|
| 10362719 | DN10 3/8 | G3/4EK | R3/8 | - | - | - |
| 10362722 | DN15 1/2 | G3/4EK | R1/2 | - | - | - |

DS 32/A

Angle regulating lockshield.
Connection for copper and plastic pipe G3/4 Eurokonus

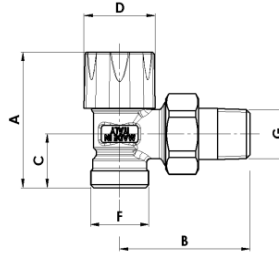

| Code | Size | A | B | C | D | E |
|----------|----------|----|----|----|----|---|
| 10162718 | DN10 3/8 | 52 | 50 | 19 | 30 | - |
| 10162721 | DN15 1/2 | 56 | 54 | 22 | 30 | - |

| Code | Size | F | G | H | L | M |
|----------|----------|--------|------|---|---|---|
| 10162718 | DN10 3/8 | G3/4EK | R3/8 | - | - | - |
| 10162721 | DN15 1/2 | G3/4EK | R1/2 | - | - | - |

DD 38/A

Straight regulating lockshield with O-ring sealing.
Connection for copper and plastic pipe G3/4 Eurokonus

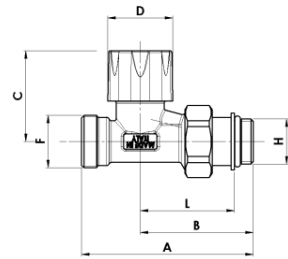

| Code | Size | A | B | C | D | E |
|----------|----------|----|----|----|----|---|
| 10362717 | DN10 3/8 | 73 | 48 | 41 | 30 | - |
| 10362703 | DN15 1/2 | 77 | 51 | 42 | 30 | - |

| Code | Size | F | G | H | L | M |
|----------|----------|--------|---|------|----|---|
| 10362717 | DN10 3/8 | G3/4EK | - | G3/8 | 38 | - |
| 10362703 | DN15 1/2 | G3/4EK | - | G1/2 | 40 | - |

DS 39/A

Angle regulating lockshield with O-ring sealing.
Connection for copper and plastic pipe G3/4 Eurokonus

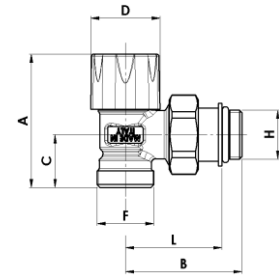

| Code | Size | A | B | C | D | E |
|----------|----------|----|----|----|----|---|
| 10162717 | DN10 3/8 | 52 | 47 | 19 | 30 | - |
| 10162703 | DN15 1/2 | 56 | 49 | 22 | 30 | - |

| Code | Size | F | G | H | L | M |
|----------|----------|--------|---|------|----|---|
| 10162717 | DN10 3/8 | G3/4EK | - | G3/8 | 37 | - |
| 10162703 | DN15 1/2 | G3/4EK | - | G1/2 | 39 | - |

Hydraulic Characteristics

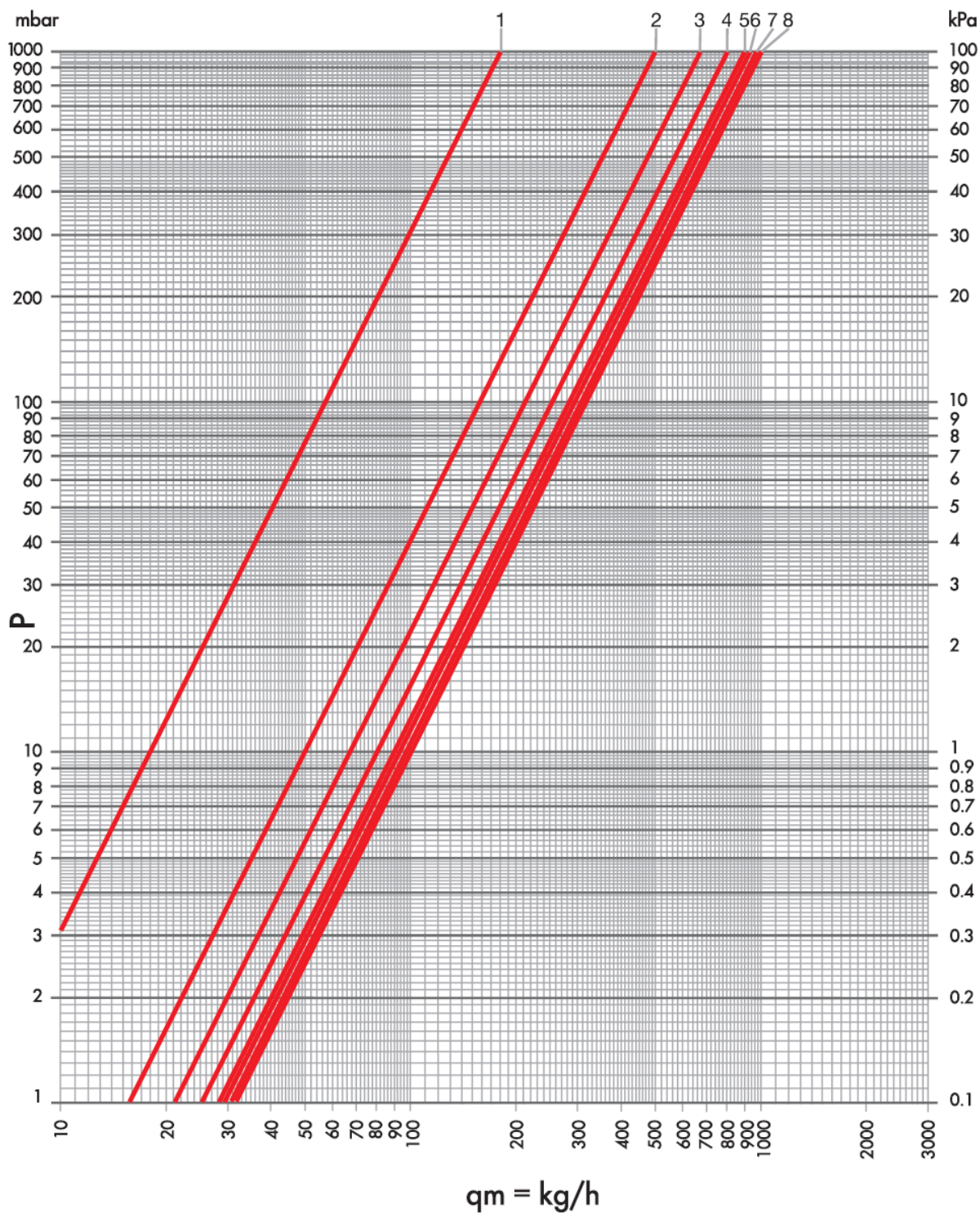

| Pos. | Turns | Kv | Items |
|------|----------|------|---|
| 1 | 1 | 0.18 | |
| 2 | 1+1/2 | 0.50 | |
| 3 | 2 | 0.67 | |
| 4 | 2+1/2 | 0.80 | |
| 5 | 3 | 0.90 | DS 22 3/8; DS 26 3/8; DS 32 3/8; DS 39 3/8; DS 32/A 3/8; DS 39/A 3/8. |
| 6 | 3+1/2 | 0.93 | |
| 7 | 4 | 0.97 | |
| 8 | All open | 1.00 | |

Hydraulic Characteristics

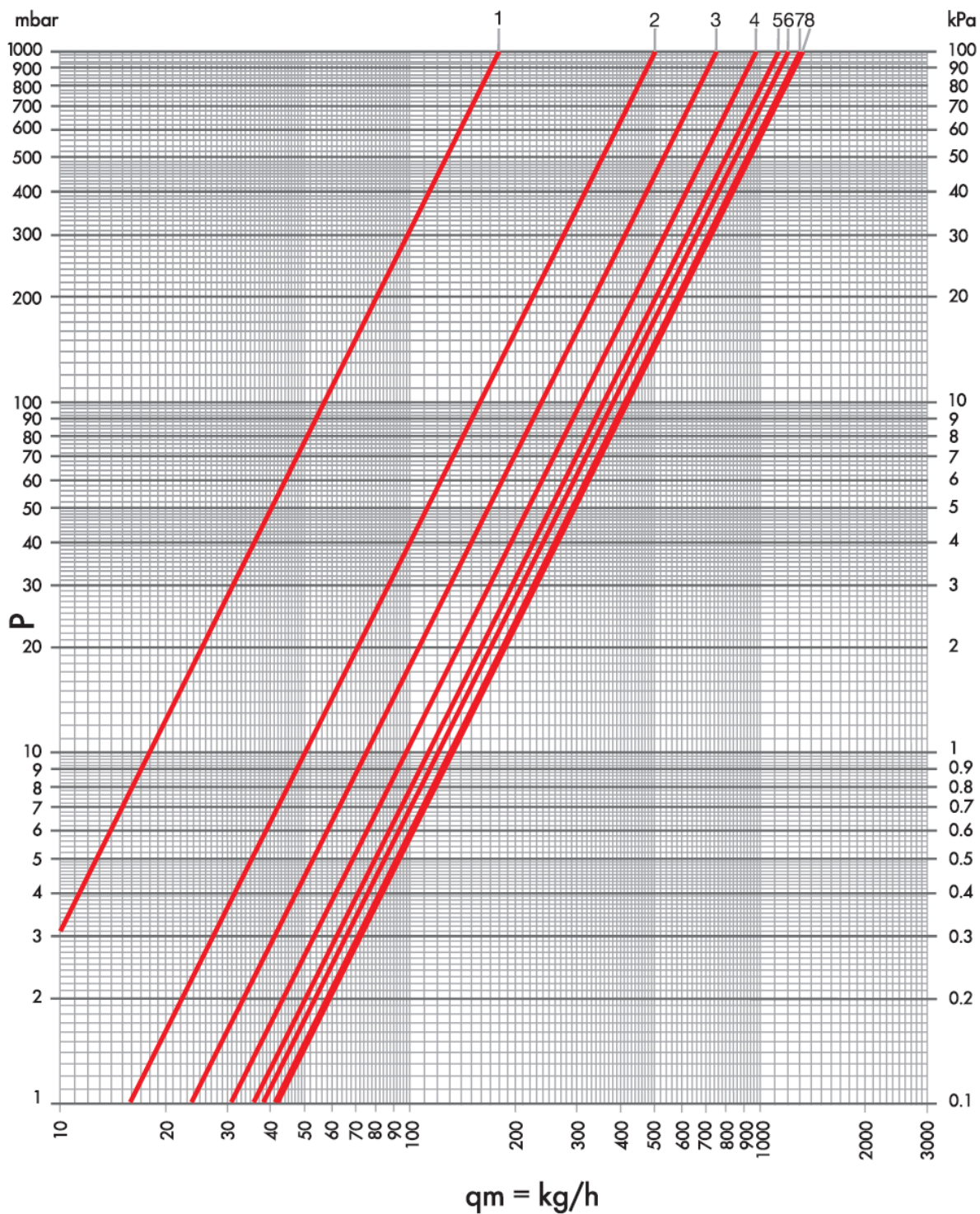

| Pos. | Turns | Kv | Items |
|------|----------|------|---|
| 1 | 1 | 0.18 | |
| 2 | 1+1/2 | 0.50 | |
| 3 | 2 | 0.75 | |
| 4 | 2+1/2 | 0.97 | |
| 5 | 3 | 1.12 | DS 22 1/2; DS 26 1/2; DS 32 1/2; DS 39 1/2; DS 32/A 1/2; DS 39/A 1/2. |
| 6 | 3+1/2 | 1.20 | |
| 7 | 4 | 1.30 | |
| 8 | All open | 1.31 | |

Hydraulic Characteristics

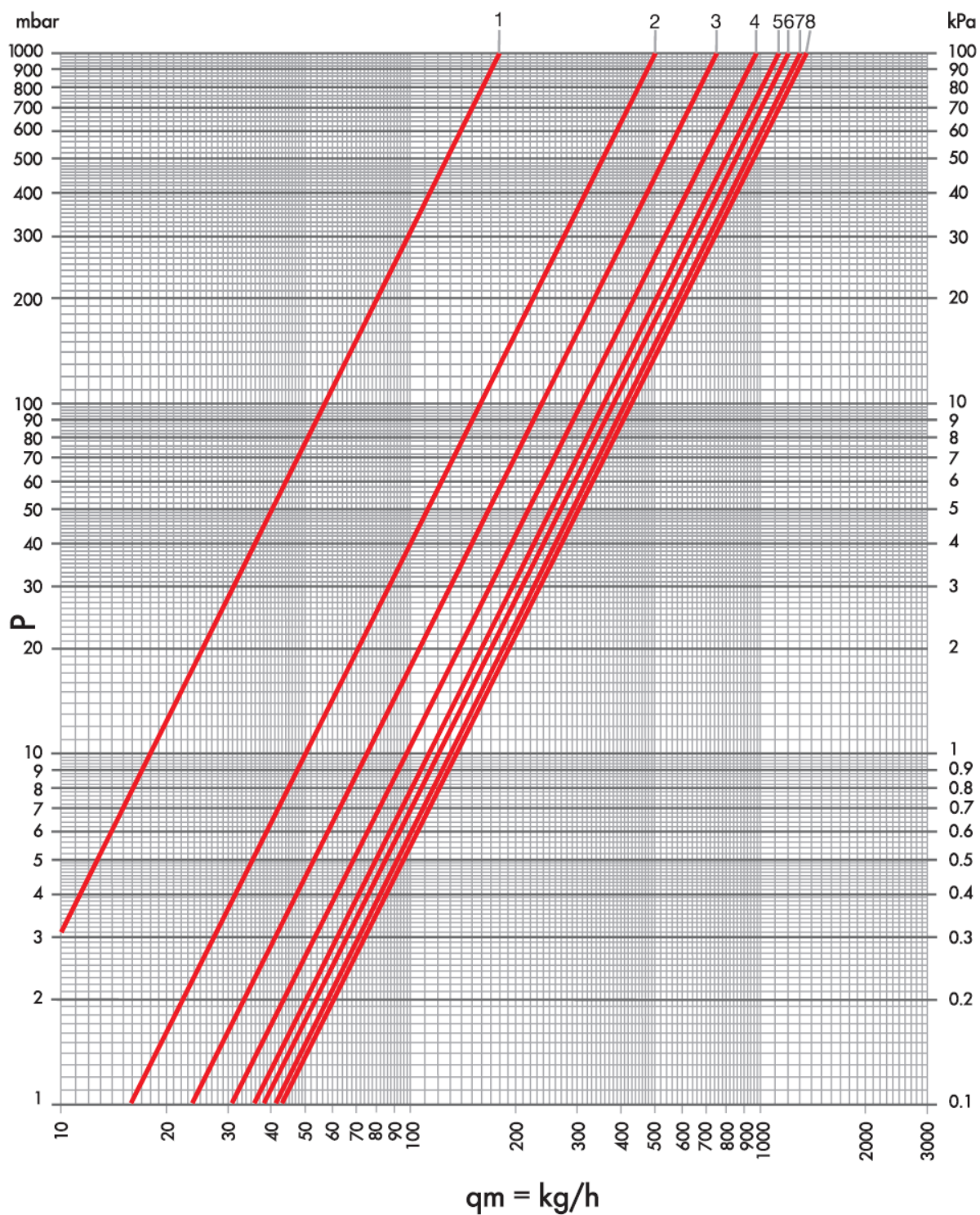

| Pos. | Turns | Kv | Items |
|------|----------|------|-----------------------|
| 1 | 1 | 0.18 | |
| 2 | 1+1/2 | 0.50 | |
| 3 | 2 | 0.75 | |
| 4 | 2+1/2 | 0.97 | |
| 5 | 3 | 1.12 | DS 22 3/4; DS 26 3/4. |
| 6 | 3+1/2 | 1.20 | |
| 7 | 4 | 1.30 | |
| 8 | All open | 1.34 | |

Hydraulic Characteristics

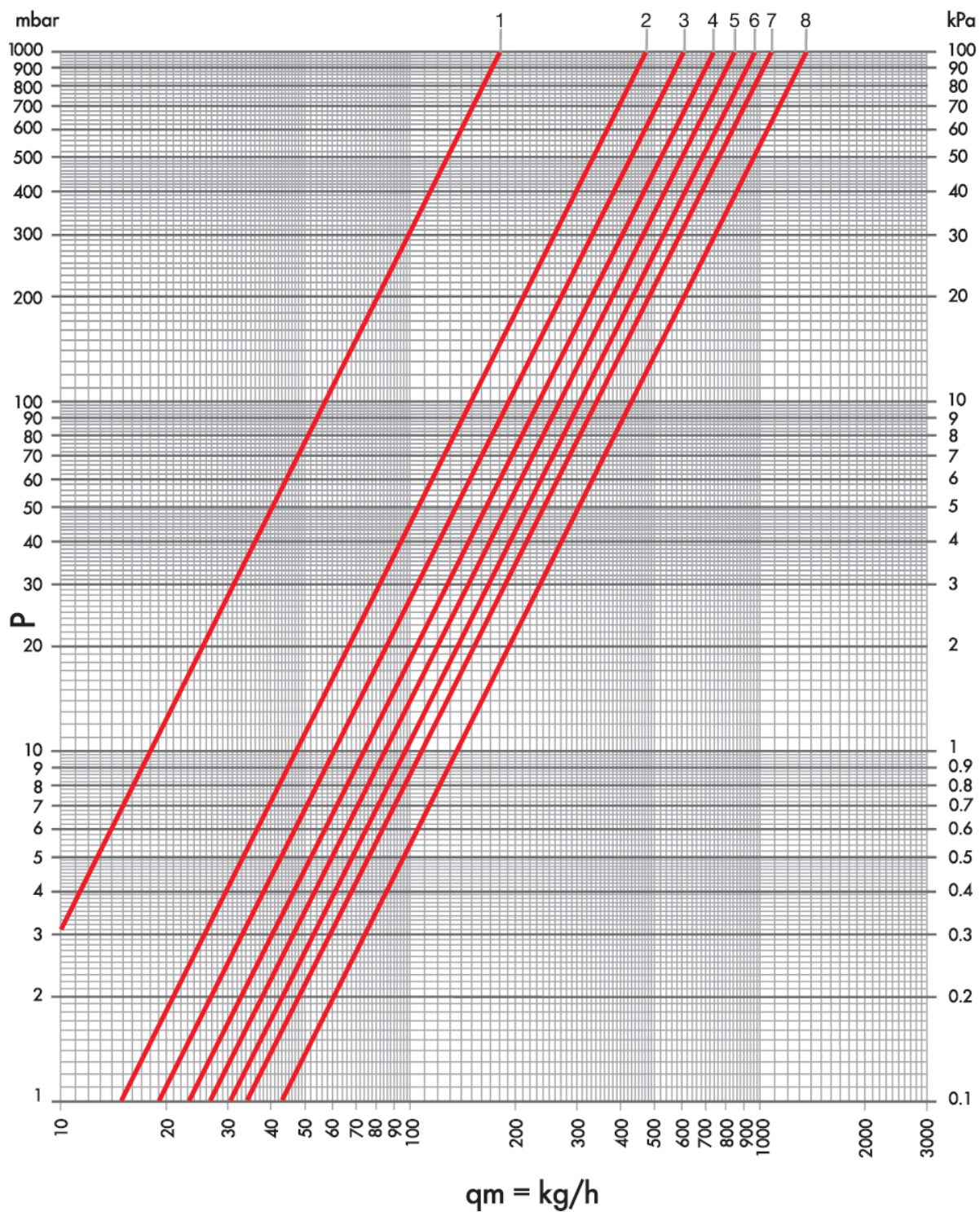

| Pos. | Turns | Kv | Items |
|------|----------|------|---|
| 1 | 1 | 0.18 | |
| 2 | 1+1/2 | 0.47 | |
| 3 | 2 | 0.60 | |
| 4 | 2+1/2 | 0.73 | DD 21 3/8; DD 25 3/8; DD 31 3/8; DD 38 3/8; DD 31/A 3/8; DD 38/A 3/8. |
| 5 | 3 | 0.84 | |
| 6 | 3+1/2 | 0.95 | |
| 7 | 4 | 1.07 | |
| 8 | All open | 1.34 | |

Hydraulic Characteristics

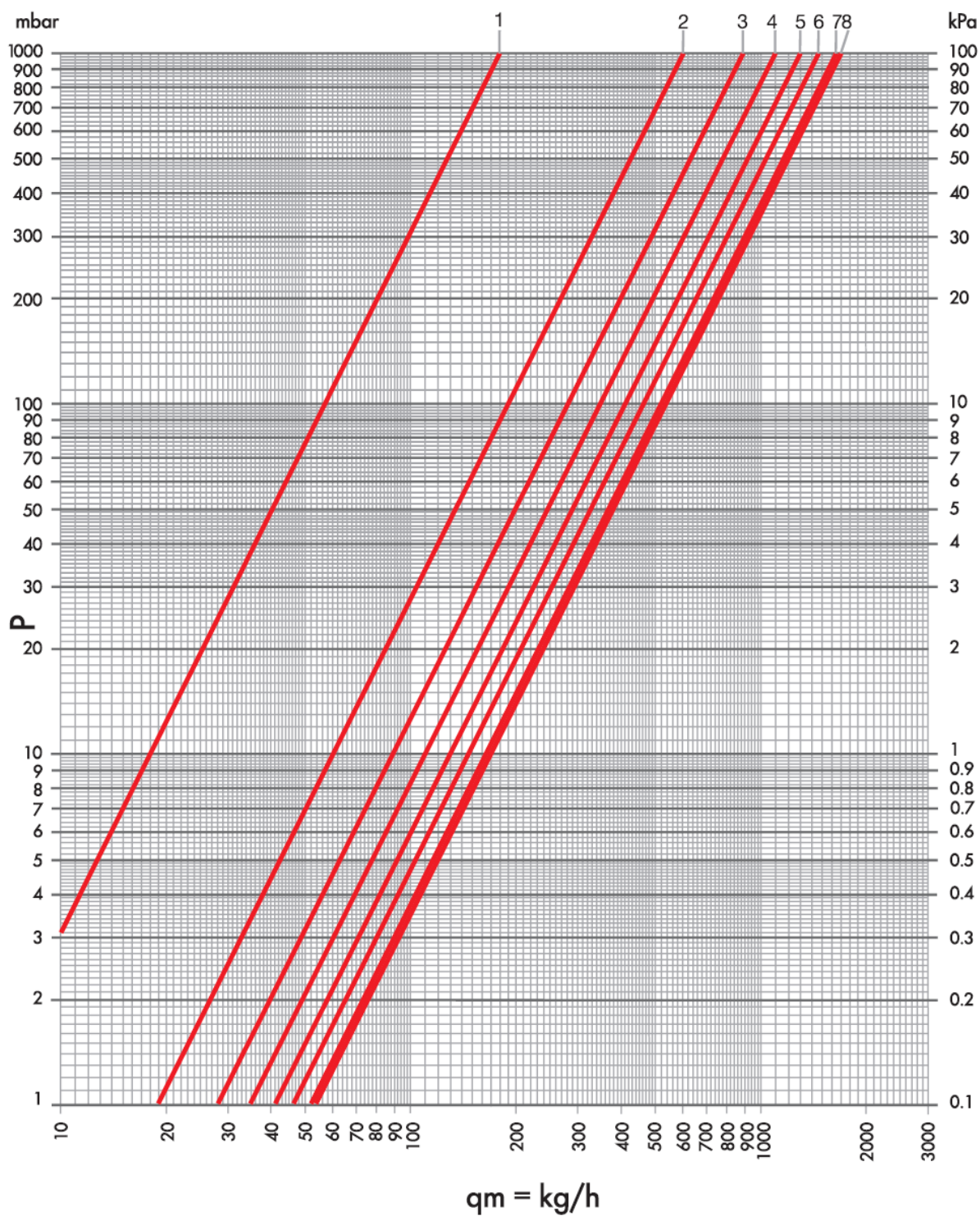

| Pos. | Turns | Kv | Items |
|------|----------|------|---|
| 1 | 1 | 0.18 | |
| 2 | 1+1/2 | 0.60 | |
| 3 | 2 | 0.89 | |
| 4 | 2+1/2 | 1.10 | DD 21 1/2; DD 25 1/2; DD 31 1/2; DD 38 1/2; DD 31/A 1/2; DD 38/A 1/2. |
| 5 | 3 | 1.30 | |
| 6 | 3+1/2 | 1.46 | |
| 7 | 4 | 1.63 | |
| 8 | All open | 1.70 | |

Hydraulic Characteristics

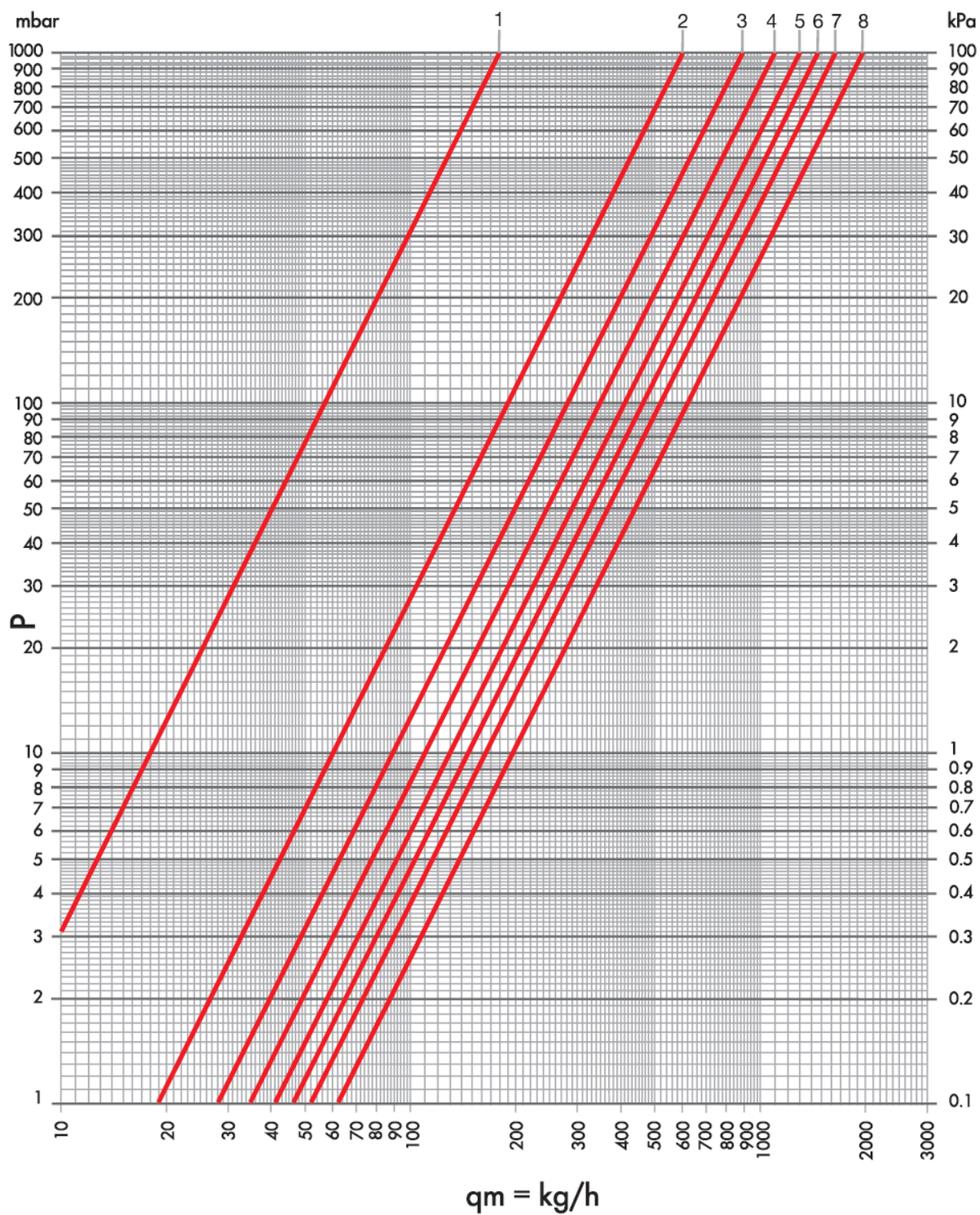

| Pos. | Turns | Kv | Items |
|------|----------|------|-----------------------|
| 1 | 1 | 0.18 | |
| 2 | 1+1/2 | 0.60 | |
| 3 | 2 | 0.89 | |
| 4 | 2+1/2 | 1.10 | DD 21 3/4; DD 25 3/4. |
| 5 | 3 | 1.30 | |
| 6 | 3+1/2 | 1.46 | |
| 7 | 4 | 1.63 | |
| 8 | All open | 1.96 | |

Working Instructions

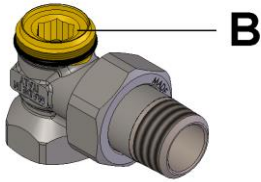
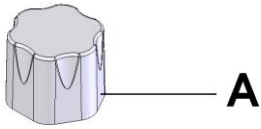

- To adjust the flow rate:
 - Unscrew the ABS plug "A";
 - Without forcing, use a 10 mm Allen key to close the obturator "B";
 - Open the obturator for a number of turns as indicated on the flow rate diagram
 - Screw back the ABS plug "A".
- **WARNING:** Once the system has been leak tested, please relieve the pressure. A differential pressure over 1 bar between the inlet and the outlet of the valve may cause the sealing O-ring to be expelled.

Item Specifications

DD 21

Straight regulating lockshield valve with ABS sealing plug. ISO 228/1 connection for iron pipe 3/8"F, 1/2"F and 3/4"F. Radiator connection with prefitted peroxide cured EPDM O-ring and DIN 2999 conical thread 3/8"M, 1/2"M and 3/4"M. Valve body in nickel-plated brass. Double EPDM O-ring sealing on the obturator and the body. Max. working temp. 120 °C, max. working pressure 10 bar, differential pressure 1 bar.

DS 22

Angle regulating lockshield valve with ABS sealing plug. ISO 228/1 connection for iron pipe 3/8"F, 1/2"F and 3/4"F. Radiator connection with prefitted peroxide cured EPDM O-ring and DIN 2999 conical thread 3/8"M, 1/2"M and 3/4"M. Valve body in nickel-plated brass. Double EPDM O-ring sealing on the obturator and the body. Max. working temp. 120 °C, max. working pressure 10 bar, differential pressure 1 bar.

DD 25

Straight regulating lockshield valve with ABS sealing plug. ISO 228/1 connection for iron pipe 3/8"F, 1/2"F and 3/4"F. Radiator connection with prefitted peroxide cured EPDM O-ring, 3/8"M and 1/2"M cylindrical thread and O-ring towards the radiator. Valve body in nickel-plated brass. Double EPDM O-ring sealing on the obturator and the body. Max. working temp. 120 °C, max. working pressure 10 bar, differential pressure 1 bar.

DS 26

Angle regulating lockshield valve with ABS sealing plug. ISO 228/1 connection for iron pipe 3/8"F, 1/2"F and 3/4"F. Radiator connection with prefitted peroxide cured EPDM O-ring, 3/8"M and 1/2"M cylindrical thread and O-ring towards the radiator. Valve body in nickel-plated brass. Double EPDM O-ring sealing on the obturator and the body. Max. working temp. 120 °C, max. working pressure 10 bar, differential pressure 1 bar.

DD 31

Straight regulating lockshield valve with ABS sealing plug. W24x19 connection for copper, plastic and multilayer pipe. Radiator connection with prefitted peroxide cured EPDM O-ring and DIN 2999 conical thread 3/8"M and 1/2"M. Valve body in nickel-plated brass. Double EPDM O-ring sealing on the obturator and the body. Max. working temp. 120 °C, max. working pressure 10 bar, differential pressure 1 bar.

DS 32

Angle regulating lockshield valve with ABS sealing plug. W24x19 connection for copper, plastic and multilayer pipe. Radiator connection with prefitted peroxide cured EPDM O-ring and DIN 2999 conical thread 3/8"M and 1/2"M. Valve body in nickel-plated brass. Double EPDM O-ring sealing on the obturator and the body. Max. working temp. 120 °C, max. working pressure 10 bar, differential pressure 1 bar.

DD 38

Straight regulating lockshield valve with ABS sealing plug. W24x19 connection for copper, plastic and multilayer pipe. 3/8"M and 1/2"M radiator connection with prefitted peroxide cured EPDM O-ring, cylindrical thread and O-ring towards the radiator. Valve body in nickel-plated brass. Double EPDM O-ring sealing on the obturator and the body. Max. working temp. 120 °C, max. working pressure 10 bar, differential pressure 1 bar.

DS 39

Angle regulating lockshield valve with ABS sealing plug. W24x19 connection for copper, plastic and multilayer pipe. 3/8"M and 1/2"M radiator connection with prefitted peroxide cured EPDM O-ring, cylindrical thread and O-ring towards the radiator. Valve body in nickel-plated brass. Double EPDM O-ring sealing on the obturator and the body. Max. working temp. 120 °C, max. working pressure 10 bar, differential pressure 1 bar.

DD 31/A

Straight regulating lockshield valve with ABS sealing plug. 3/4"M EK connection for copper, plastic and multilayer pipe. 1/2"M radiator connection with prefitted peroxide cured EPDM O-ring, DIN 2999 conical thread. Valve body in nickel-plated brass. Double EPDM O-ring sealing on the obturator and the body. Max. working temp. 120 °C, max. working pressure 10 bar, differential pressure 1 bar.

DS 32/A

Angle regulating lockshield valve with ABS sealing plug. 3/4"M EK connection for copper, plastic and multilayer pipe. 1/2"M radiator connection with prefitted peroxide cured EPDM O-ring, DIN 2999 conical thread. Valve body in nickel-plated brass. Double EPDM O-ring sealing on the obturator and the body. Max. working temp. 120 °C, max. working pressure 10 bar, differential pressure 1 bar.

DD 38/A

Straight regulating lockshield valve with ABS sealing plug. 3/4"M EK connection for copper, plastic and multilayer pipe. 3/8"M and 1/2"M radiator connection with prefitted peroxide cured EPDM O-ring, cylindrical thread and O-ring towards the radiator. Double EPDM O-ring sealing on the obturator and the body. Max. working temp. 120 °C, max. working pressure 10 bar,

differential pressure 1 bar.

DS 39/A

Angle regulating lockshield valve with ABS sealing plug. 3/4" M EK connection for copper, plastic and multilayer pipe. 3/8" M and 1/2" M radiator connection with prefitted peroxide cured EPDM O-ring, cylindrical thread and O-ring towards the radiator. Double EPDM O-ring sealing on the obturator and the body. Max. working temp. 120 °C, max. working pressure 10 bar, differential pressure 1 bar.



Luxor S.p.A.

Sede amministrativa, stabilimento e uffici commerciali:

Administrative office, factory and commercial office:

Tel.: 030-9961161 – Fax: 030-9961165

info@luxor.it – www.luxor.it

via Madonnina, 94 – 25018 Montichiari - (BS)

*Luxor si riserva il diritto di apportare miglioramenti e modifiche ai prodotti descritti ed ai relativi dati tecnici in qualsiasi momento e senza preavviso
Luxor reserves the right to ameliorate and modify the products described above and their technical data at any time and without notice*

THERMOTEKNA

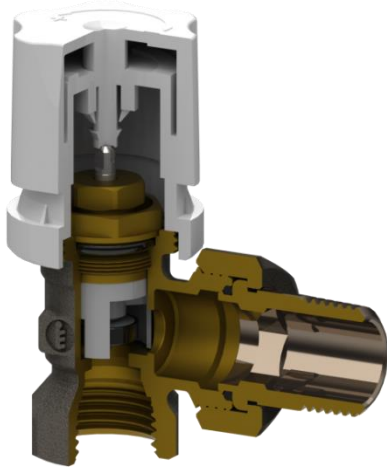

Function

ThermoTekna valves are suitable for any hot-water based heating system. Their function is to intercept the fluid and they allow to control the heating bodies. When used with thermostatic heads, these valves can make each room independent with a specific set temperature, thus enhancing comfort and actual energy saving, as prescribed by national and international regulations. Inside the valve body, the openings of a shaped acetal ring determine exactly the flow rate. The desired maximum flow rate can be set by simply rotating the stem to the corresponding position, without any intervention inside the valve. The thermostatic screw allows to replace one of the O-rings on the control stem without draining the system.

To avoid excessive noise in the system it is recommended not to use thermostatic valves with ΔP value above 0,2-0,25 bar.

Technical data

| | |
|-----------------------------|--|
| Max. working pressure: | 10 bar |
| Max. differential pressure: | 1 bar |
| Max. working temperature: | 120 °C |
| Working fluids: | Water in compliance with UNI 8065:1989 |

Materials

| | |
|-----------------|---------------------------------|
| Valve body: | CW 617 N – DW UNI-EN 12165:2016 |
| Obturator: | CW 614 N – DW UNI-EN 12164:2016 |
| Gaskets: | Peroxide cured EPDM |
| Adjustment knob | Acetal |
| Steek parts | Stainless steel |
| Knob: | RAL9016 white ABS |

Surface treatment

Nickel-plating

Dimensional Drawings

RD 201

Straight radiator valve, thermostatically or electronically controlled with protection cap.
Connection for iron pipe.

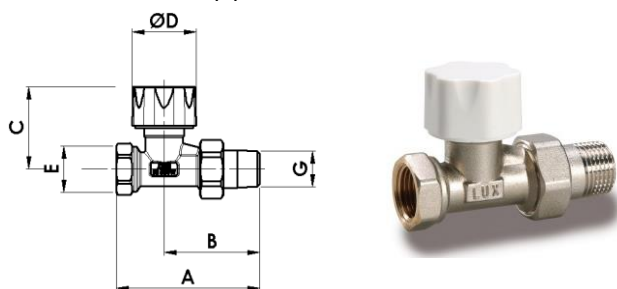

| Code | Size | A | B | C | D | E |
|----------|----------|----|----|----|----|------|
| 12221700 | DN10 3/8 | 76 | 51 | 46 | 37 | G3/8 |
| 12222100 | DN15 1/2 | 83 | 55 | 46 | 37 | G1/2 |
| 12222700 | DN20 3/4 | 97 | 65 | 47 | 37 | G3/4 |

| Code | Size | F | G | H | L | M |
|----------|----------|---|------|---|---|---|
| 12221700 | DN10 3/8 | - | R3/8 | - | - | - |
| 12222100 | DN15 1/2 | - | R1/2 | - | - | - |
| 12222700 | DN20 3/4 | - | R3/4 | - | - | - |

RS 202

Angle radiator valve, thermostatically or electronically controlled with protection cap.
Connection for iron pipe.

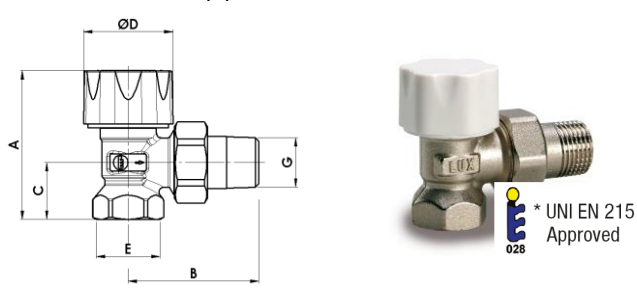

| Code | Size | A | B | C | D | E |
|-----------|----------|----|----|----|----|------|
| 12021700 | DN10 3/8 | 58 | 50 | 20 | 37 | G3/8 |
| 12022100* | DN15 1/2 | 60 | 53 | 23 | 37 | G1/2 |
| 12022700 | DN20 3/4 | 60 | 62 | 27 | 37 | G3/4 |

| Code | Size | F | G | H | L | M |
|-----------|----------|---|------|---|---|---|
| 12021700 | DN10 3/8 | - | R3/8 | - | - | - |
| 12022100* | DN15 1/2 | - | R1/2 | - | - | - |
| 12022700 | DN20 3/4 | - | R3/4 | - | - | - |

RD 2501

Straight radiator valve, thermostatically or electronically controlled, with manual control knob.
Connection for iron pipe.

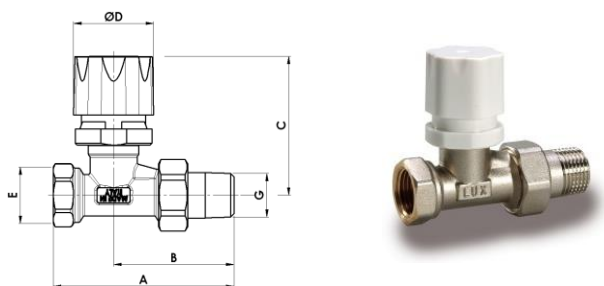

| Code | Size | A | B | C | D | E |
|----------|----------|----|----|----|----|------|
| 12421700 | DN10 3/8 | 76 | 51 | 64 | 37 | G3/8 |
| 12422100 | DN15 1/2 | 83 | 55 | 64 | 37 | G1/2 |
| 12422700 | DN20 3/4 | 97 | 65 | 65 | 37 | G3/4 |

| Code | Size | F | G | H | L | M |
|----------|----------|---|---|------|---|---|
| 12421700 | DN10 3/8 | - | - | G3/8 | - | - |
| 12422100 | DN15 1/2 | - | - | G1/2 | - | - |
| 12422700 | DN20 3/4 | - | - | G3/4 | - | - |

RS 2502

Angle radiator valve, thermostatically or electronically controlled, with manual control knob.
Connection for iron pipe.

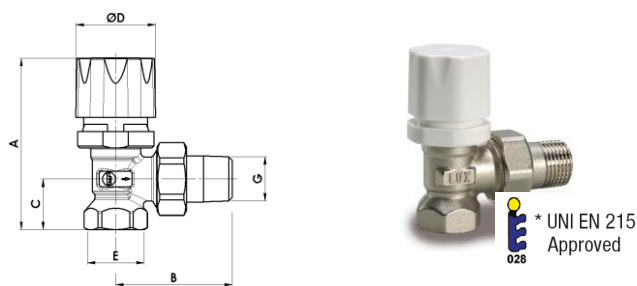

| Code | Size | A | B | C | D | E |
|-----------|----------|----|----|----|----|------|
| 12621700 | DN10 3/8 | 75 | 50 | 20 | 37 | G3/8 |
| 12622100* | DN15 1/2 | 78 | 53 | 23 | 37 | G1/2 |
| 12622700 | DN20 3/4 | 78 | 62 | 27 | 37 | G3/4 |

| Code | Size | F | G | H | L | M |
|-----------|----------|---|---|------|---|---|
| 12621700 | DN10 3/8 | - | - | G3/8 | - | - |
| 12622100* | DN15 1/2 | - | - | G1/2 | - | - |
| 12622700 | DN20 3/4 | - | - | G3/4 | - | - |

RD 205

Straight radiator valve, thermostatically or electronically controlled with protection cap. Unions with O-rings. Connection for iron pipe.

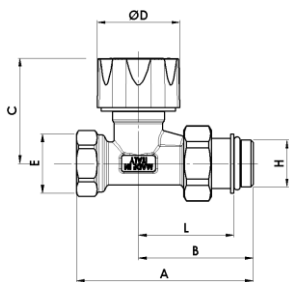

| Code | Size | A | B | C | D | E |
|----------|----------|----|----|------|----|------|
| 12222117 | DN10 3/8 | 73 | 48 | 46 | 37 | G3/8 |
| 12222103 | DN15 1/2 | 78 | 51 | 46 | 37 | G1/2 |
| 12222703 | DN20 3/4 | 95 | 63 | 47 | 37 | G3/4 |
| Code | Size | F | G | H | L | M |
| 12222117 | DN10 3/8 | - | - | G3/8 | 38 | - |
| 12222103 | DN15 1/2 | - | - | G1/2 | 40 | - |
| 12222703 | DN20 3/4 | - | - | G3/4 | 51 | - |

RS 206

Angle radiator valve, thermostatically or electronically controlled with protection cap. Unions with O-rings. Connection for iron pipe.

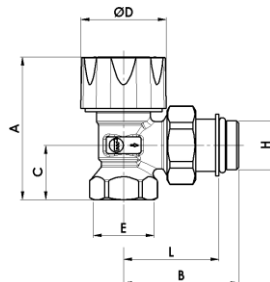

* UNI EN 215
Approved
028

| Code | Size | A | B | C | D | E |
|-----------|----------|----|----|------|----|------|
| 12022117 | DN10 3/8 | 58 | 47 | 20 | 37 | G3/8 |
| 12022103* | DN15 1/2 | 61 | 49 | 23 | 37 | G1/2 |
| 12022703 | DN20 3/4 | 60 | 60 | 27 | 37 | G3/4 |
| Code | Size | F | G | H | L | M |
| 12022117 | DN10 3/8 | - | - | G3/8 | 37 | - |
| 12022103* | DN15 1/2 | - | - | G1/2 | 39 | - |
| 12022703 | DN20 3/4 | - | - | G3/4 | 48 | - |

RD 2505

Straight radiator valve, thermostatically or electronically controlled, with manual control knob. Unions with O-rings. Connection for iron pipe.

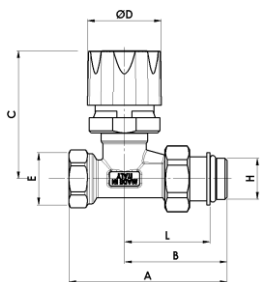

| Code | Size | A | B | C | D | E |
|----------|----------|----|----|------|----|------|
| 12422117 | DN10 3/8 | 73 | 48 | 64 | 37 | G3/4 |
| 12422103 | DN15 1/2 | 78 | 51 | 64 | 37 | G1/2 |
| 12422703 | DN20 3/4 | 95 | 63 | 65 | 37 | G3/4 |
| Code | Size | F | G | H | L | M |
| 12422117 | DN10 3/8 | - | - | G3/8 | 38 | - |
| 12422103 | DN15 1/2 | - | - | G1/2 | 40 | - |
| 12422703 | DN20 3/4 | - | - | G3/4 | 51 | - |

RS 2506

Angle radiator valve, thermostatically or electronically controlled, with manual control knob. Unions with O-rings. Connection for iron pipe.

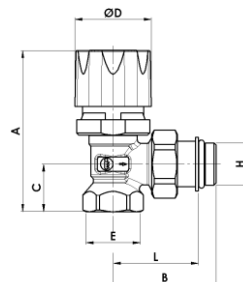

* UNI EN 215
Approved
028

| Code | Size | A | B | C | D | E |
|-----------|----------|----|----|------|----|------|
| 12622117 | DN10 3/8 | 75 | 47 | 20 | 37 | G3/4 |
| 12622103* | DN15 1/2 | 78 | 49 | 23 | 37 | G1/2 |
| 12622703 | DN20 3/4 | 78 | 60 | 27 | 37 | G3/4 |
| Code | Size | F | G | H | L | M |
| 12622117 | DN10 3/8 | - | - | G3/8 | 37 | - |
| 12622103* | DN15 1/2 | - | - | G1/2 | 39 | - |
| 12622703 | DN20 3/4 | - | - | G3/4 | 48 | - |

RD 211

Straight radiator valve, thermostatically or electronically controlled with protection cap.
Copper and plastic pipe W24x19"

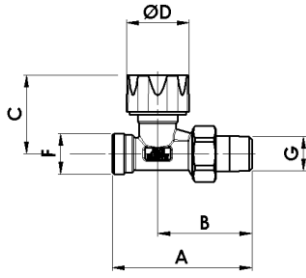

| Code | Size | A | B | C | D | E |
|----------|-----------------|------|----|----|----|---|
| 12321700 | DN10 3/8 | 76 | 51 | 46 | 37 | - |
| 12322100 | DN15 1/2 | 81 | 55 | 46 | 37 | - |
| Code | Size | F | G | H | L | M |
| 12321700 | DN10 3/8 W24x19 | R3/8 | - | - | - | - |
| 12322100 | DN15 1/2 W24x19 | R1/2 | - | - | - | - |

RS 212

Angle radiator valve, thermostatically or electronically controlled with protection cap.
Copper and plastic pipe W24x19"

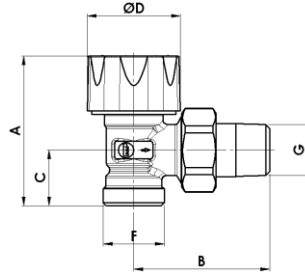

| Code | Size | A | B | C | D | E |
|-----------|-----------------|------|----|----|----|---|
| 12121700* | DN10 3/8 | 57 | 52 | 19 | 37 | - |
| 12122100* | DN15 1/2 | 59 | 54 | 22 | 37 | - |
| Code | Size | F | G | H | L | M |
| 12121700* | DN10 3/8 W24x19 | R3/8 | - | - | - | - |
| 12122100* | DN15 1/2 W24x19 | R1/2 | - | - | - | - |

RD 2511

Straight radiator valve, thermostatically or electronically controlled, with manual control knob.
Copper and plastic pipe W24x19"

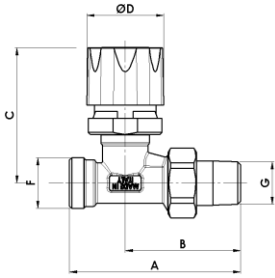

| Code | Size | A | B | C | D | E |
|----------|-----------------|------|----|----|----|---|
| 12521700 | DN10 3/8 | 76 | 51 | 64 | 37 | - |
| 12522100 | DN15 1/2 | 81 | 55 | 64 | 37 | - |
| Code | Size | F | G | H | L | M |
| 12521700 | DN10 3/8 W24x19 | R3/8 | - | - | - | - |
| 12522100 | DN15 1/2 W24x19 | R1/2 | - | - | - | - |

RS 2512

Angle radiator valve, thermostatically or electronically controlled, with manual control knob.
Copper and plastic pipe W24x19"

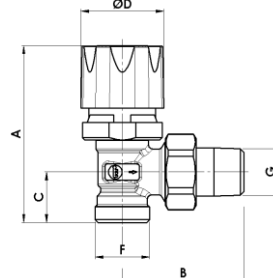

| Code | Size | A | B | C | D | E |
|-----------|-----------------|------|----|----|----|---|
| 12721700* | DN10 3/8 | 74 | 52 | 19 | 37 | - |
| 12722100* | DN15 1/2 | 77 | 54 | 22 | 37 | - |
| Code | Size | F | G | H | L | M |
| 12721700* | DN10 3/8 W24x19 | R3/8 | - | - | - | - |
| 12722100* | DN15 1/2 W24x19 | R1/2 | - | - | - | - |

RD 208

Straight radiator valve, thermostatically or electronically controlled with protection cap. Unions with O-rings. Copper and plastic pipe W24x19"

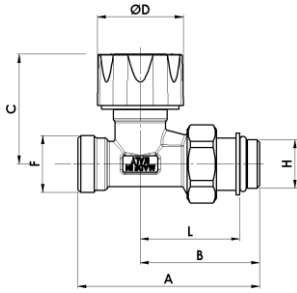

| Code | Size | A | B | C | D | E |
|----------|-----------------|----|------|----|----|---|
| 12322117 | DN10 3/8 | 73 | 48 | 46 | 37 | - |
| 12322103 | DN15 1/2 | 78 | 51 | 46 | 37 | - |
| Code | Size | F | G | H | L | M |
| 12322117 | DN10 3/8 W24x19 | - | G3/8 | 38 | - | - |
| 12322103 | DN15 1/2 W24x19 | - | G1/2 | 40 | - | - |

RS 209

Angle radiator valve, thermostatically or electronically controlled with protection cap. Unions with O-rings. Copper and plastic pipe W24x19"

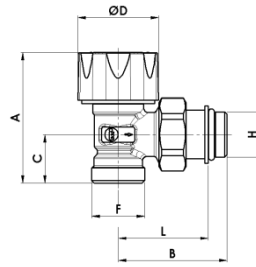

* UNI EN 215
028 Approved

| Code | Size | A | B | C | D | E |
|-----------|-----------------|----|------|----|----|---|
| 12122117* | DN10 3/8 | 57 | 47 | 19 | 37 | - |
| 12122103* | DN15 1/2 | 60 | 49 | 22 | 37 | - |
| Code | Size | F | G | H | L | M |
| 12122117* | DN10 3/8 W24x19 | - | G3/8 | 37 | - | - |
| 12122103* | DN15 1/2 W24x19 | - | G1/2 | 39 | - | - |

RD 2508

Straight radiator valve, thermostatically or electronically controlled, with manual control knob. Unions with O-rings. Copper and plastic pipe W24x19"

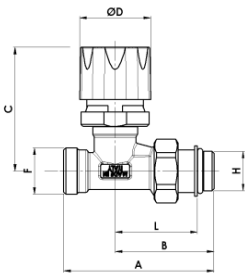

| Code | Size | A | B | C | D | E |
|----------|-----------------|----|------|----|----|---|
| 12522117 | DN10 3/8 | 73 | 48 | 67 | 37 | - |
| 12522103 | DN15 1/2 | 77 | 51 | 64 | 37 | - |
| Code | Size | F | G | H | L | M |
| 12522117 | DN10 3/8 W24x19 | - | G3/8 | 38 | - | - |
| 12522103 | DN15 1/2 W24x19 | - | G1/2 | 40 | - | - |

RS 2509

Angle radiator valve, thermostatically or electronically controlled, with manual control knob. Unions with O-rings. Copper and plastic pipe W24x19"

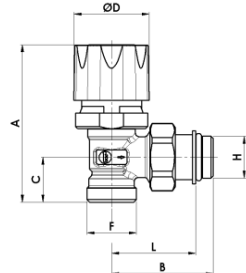

* UNI EN 215
028 Approved

| Code | Size | A | B | C | D | E |
|-----------|-----------------|----|------|----|----|---|
| 12722117* | DN10 3/8 | 74 | 47 | 19 | 37 | - |
| 12722103* | DN15 1/2 | 77 | 49 | 22 | 37 | - |
| Code | Size | F | G | H | L | M |
| 12722117* | DN10 3/8 W24x19 | - | G3/8 | 37 | - | - |
| 12722103* | DN15 1/2 W24x19 | - | G1/2 | 39 | - | - |

RD 211/A

Straight radiator valve, thermostatically or electronically controlled with protection cap.
Copper and plastic pipe G3/4 Eurokonus

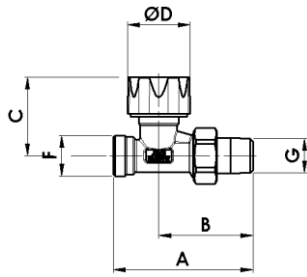

| Code | Size | A | B | C | D | E |
|----------|----------|----|----|----|----|---|
| 12322719 | DN10 3/8 | 77 | 52 | 46 | 37 | - |
| 12322722 | DN15 1/2 | 81 | 55 | 46 | 37 | - |

| Code | Size | F | G | H | L | M |
|----------|----------|--------|------|---|---|---|
| 12322719 | DN10 3/8 | G3/4EK | R3/8 | - | - | - |
| 12322722 | DN15 1/2 | G3/4EK | R1/2 | - | - | - |

RS 212/A

Angle radiator valve, thermostatically or electronically controlled with protection cap.
Copper and plastic pipe G3/4 Eurokonus

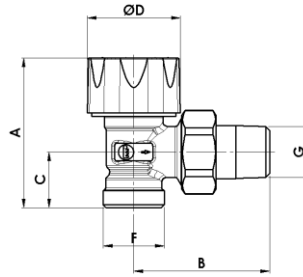

 * UNI EN 215
Approved

| Code | Size | A | B | C | D | E |
|-----------|----------|----|----|----|----|---|
| 12122718* | DN10 3/8 | 56 | 50 | 19 | 37 | - |
| 12122721* | DN15 1/2 | 59 | 54 | 22 | 37 | - |

| Code | Size | F | G | H | L | M |
|-----------|----------|--------|------|---|---|---|
| 12122718* | DN10 3/8 | G3/4EK | R3/8 | - | - | - |
| 12122721* | DN15 1/2 | G3/4EK | R1/2 | - | - | - |

RD 2511/A

Straight radiator valve, thermostatically or electronically controlled, with manual control knob.
Copper and plastic pipe G3/4 Eurokonus

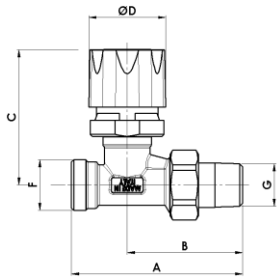

| Code | Size | A | B | C | D | E |
|----------|----------|----|----|----|----|---|
| 12522719 | DN10 3/8 | 77 | 52 | 64 | 37 | - |
| 12522722 | DN15 1/2 | 81 | 55 | 64 | 37 | - |

| Code | Size | F | G | H | L | M |
|----------|----------|--------|------|---|---|---|
| 12522719 | DN10 3/8 | G3/4EK | R3/8 | - | - | - |
| 12522722 | DN15 1/2 | G3/4EK | R1/2 | - | - | - |

RS 2512/A

Angle radiator valve, thermostatically or electronically controlled, with manual control knob.
Copper and plastic pipe G3/4 Eurokonus

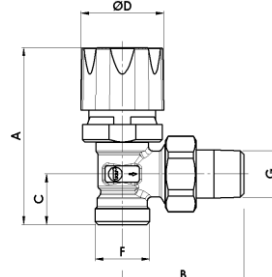

 * UNI EN 215
Approved

| Code | Size | A | B | C | D | E |
|-----------|----------|----|----|----|----|---|
| 12722718* | DN10 3/8 | 74 | 52 | 19 | 37 | - |
| 12722721* | DN15 1/2 | 77 | 54 | 22 | 37 | - |

| Code | Size | F | G | H | L | M |
|-----------|----------|--------|------|---|---|---|
| 12722718* | DN10 3/8 | G3/4EK | R3/8 | - | - | - |
| 12722721* | DN15 1/2 | G3/4EK | R1/2 | - | - | - |

RD 208/A

Straight radiator valve, thermostatically or electronically controlled with protection cap. Unions with O-rings. Copper and plastic pipe G3/4 Eurokonus

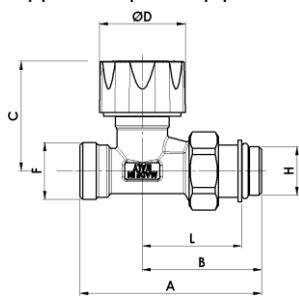

| Code | Size | A | B | C | D | E |
|----------|----------|----|----|----|----|---|
| 12322719 | DN10 3/8 | 73 | 48 | 46 | 37 | - |
| 12322722 | DN15 1/2 | 77 | 51 | 46 | 37 | - |

| Code | Size | F | G | H | L | M |
|----------|----------|--------|---|------|----|---|
| 12322719 | DN10 3/8 | G3/4EK | - | G3/8 | 38 | - |
| 12322722 | DN15 1/2 | G3/4EK | - | G1/2 | 40 | - |

RS 209/A

Angle radiator valve, thermostatically or electronically controlled with protection cap. Unions with O-rings. Copper and plastic pipe G3/4 Eurokonus

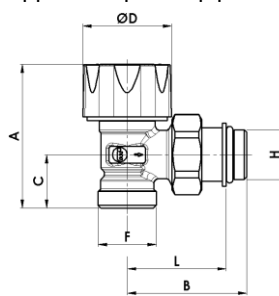

 * UNI EN 215 Approved

| Code | Size | A | B | C | D | E |
|-----------|----------|----|----|----|----|---|
| 12122718* | DN10 3/8 | 57 | 47 | 19 | 37 | - |
| 12122721* | DN15 1/2 | 60 | 49 | 22 | 37 | - |

| Code | Size | F | G | H | L | M |
|-----------|----------|--------|---|------|----|---|
| 12122718* | DN10 3/8 | G3/4EK | - | G3/8 | 37 | - |
| 12122721* | DN15 1/2 | G3/4EK | - | G1/2 | 39 | - |

RD 2508/A

Straight radiator valve, thermostatically or electronically controlled, with manual control knob. Unions with O-rings. Copper and plastic pipe G3/4 Eurokonus

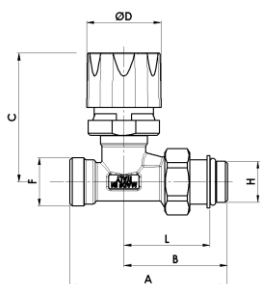

| Code | Size | A | B | C | D | E |
|----------|----------|----|----|----|----|---|
| 12522717 | DN10 3/8 | 73 | 48 | 64 | 37 | - |
| 12522703 | DN15 1/2 | 77 | 51 | 64 | 37 | - |

| Code | Size | F | G | H | L | M |
|----------|----------|--------|---|------|----|---|
| 12522717 | DN10 3/8 | G3/4EK | - | G3/8 | 38 | - |
| 12522703 | DN15 1/2 | G3/4EK | - | G1/2 | 40 | - |

RS 2509/A

Angle radiator valve, thermostatically or electronically controlled, with manual control knob. Unions with O-rings. Copper and plastic pipe G3/4 Eurokonus

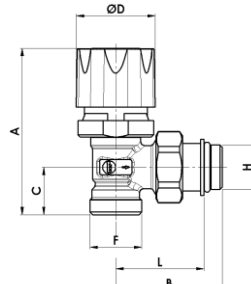

 * UNI EN 215 Approved

| Code | Size | A | B | C | D | E |
|-----------|----------|----|----|----|----|---|
| 12722717* | DN10 3/8 | 74 | 47 | 19 | 37 | - |
| 12722703* | DN15 1/2 | 77 | 49 | 22 | 37 | - |

| Code | Size | F | G | H | L | M |
|-----------|----------|--------|---|------|----|---|
| 12722717* | DN10 3/8 | G3/4EK | - | G3/8 | 37 | - |
| 12722703* | DN15 1/2 | G3/4EK | - | G1/2 | 39 | - |

M 320

Reverse angle radiator valve, thermostatically or electronically controlled, with protection cap.
Copper and plastic pipe W24x19"

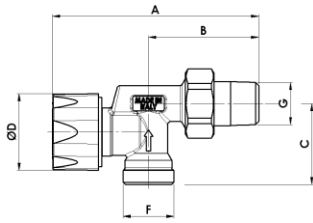

| Code | Size | A | B | C | D | E |
|----------|----------|--------|------|----|----|---|
| - | - | - | - | - | - | - |
| 13102100 | DN15 1/2 | 95 | 52 | 39 | 37 | - |
| Code | Size | F | G | H | L | M |
| - | - | - | - | - | - | - |
| 13102100 | DN15 1/2 | W24x19 | R1/2 | - | - | - |

M 330

Reverse angle radiator valve, thermostatically or electronically controlled, with manual control knob.
Copper and plastic pipe W24x19"

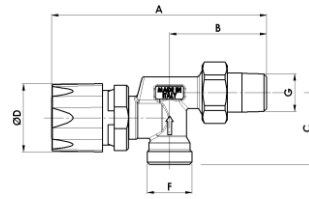

| Code | Size | A | B | C | D | E |
|----------|----------|--------|------|----|----|---|
| - | - | - | - | - | - | - |
| 13122100 | DN15 1/2 | 116 | 52 | 39 | 35 | - |
| Code | Size | F | G | H | L | M |
| - | - | - | - | - | - | - |
| 13122100 | DN15 1/2 | W24x19 | R1/2 | - | - | - |

M 320/A

Reverse angle radiator valve, thermostatically or electronically controlled, with protection cap.
Copper and plastic pipe G3/4 Eurokonus

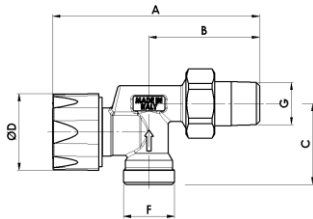

| Code | Size | A | B | C | D | E |
|----------|----------|--------|------|----|----|---|
| - | - | - | - | - | - | - |
| 13102721 | DN15 1/2 | 95 | 52 | 39 | 37 | - |
| Code | Size | F | G | H | L | M |
| - | - | - | - | - | - | - |
| 13102721 | DN15 1/2 | G3/4EK | R1/2 | - | - | - |

M 330/A

Reverse angle radiator valve, thermostatically or electronically controlled, with manual control knob.
Copper and plastic pipe G3/4 Eurokonus

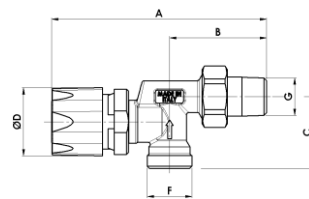

| Code | Size | A | B | C | D | E |
|----------|----------|--------|------|----|----|---|
| - | - | - | - | - | - | - |
| 13122721 | DN15 1/2 | 116 | 52 | 39 | 35 | - |
| Code | Size | F | G | H | L | M |
| - | - | - | - | - | - | - |
| 13122721 | DN15 1/2 | G3/4EK | R1/2 | - | - | - |

M 322

Reverse angle radiator valve, thermostatically or electronically controlled, with protection cap.
Connection for iron pipe.

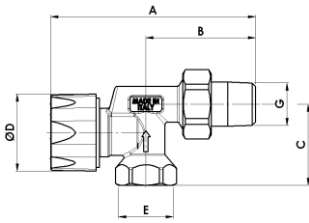

M 332

Reverse angle radiator valve, thermostatically or electronically controlled, with manual control knob.
Connection for iron pipe.

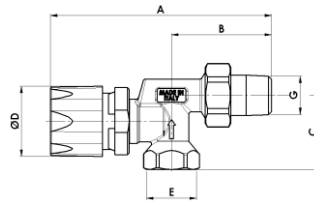

| Code | Size | A | B | C | D | E |
|----------|----------|----|----|----|----|------|
| - | - | - | - | - | - | - |
| 13202100 | DN15 1/2 | 95 | 52 | 40 | 37 | G1/2 |

| Code | Size | F | G | H | L | M |
|----------|----------|---|------|---|---|---|
| - | - | - | - | - | - | - |
| 13202100 | DN15 1/2 | - | R1/2 | - | - | - |

| Code | Size | A | B | C | D | E |
|----------|----------|-----|----|----|----|------|
| - | - | - | - | - | - | - |
| 13222100 | DN15 1/2 | 116 | 52 | 40 | 35 | G1/2 |

| Code | Size | F | G | H | L | M |
|----------|----------|---|------|---|---|---|
| - | - | - | - | - | - | - |
| 13222100 | DN15 1/2 | - | R1/2 | - | - | - |

Hydraulic Characteristics

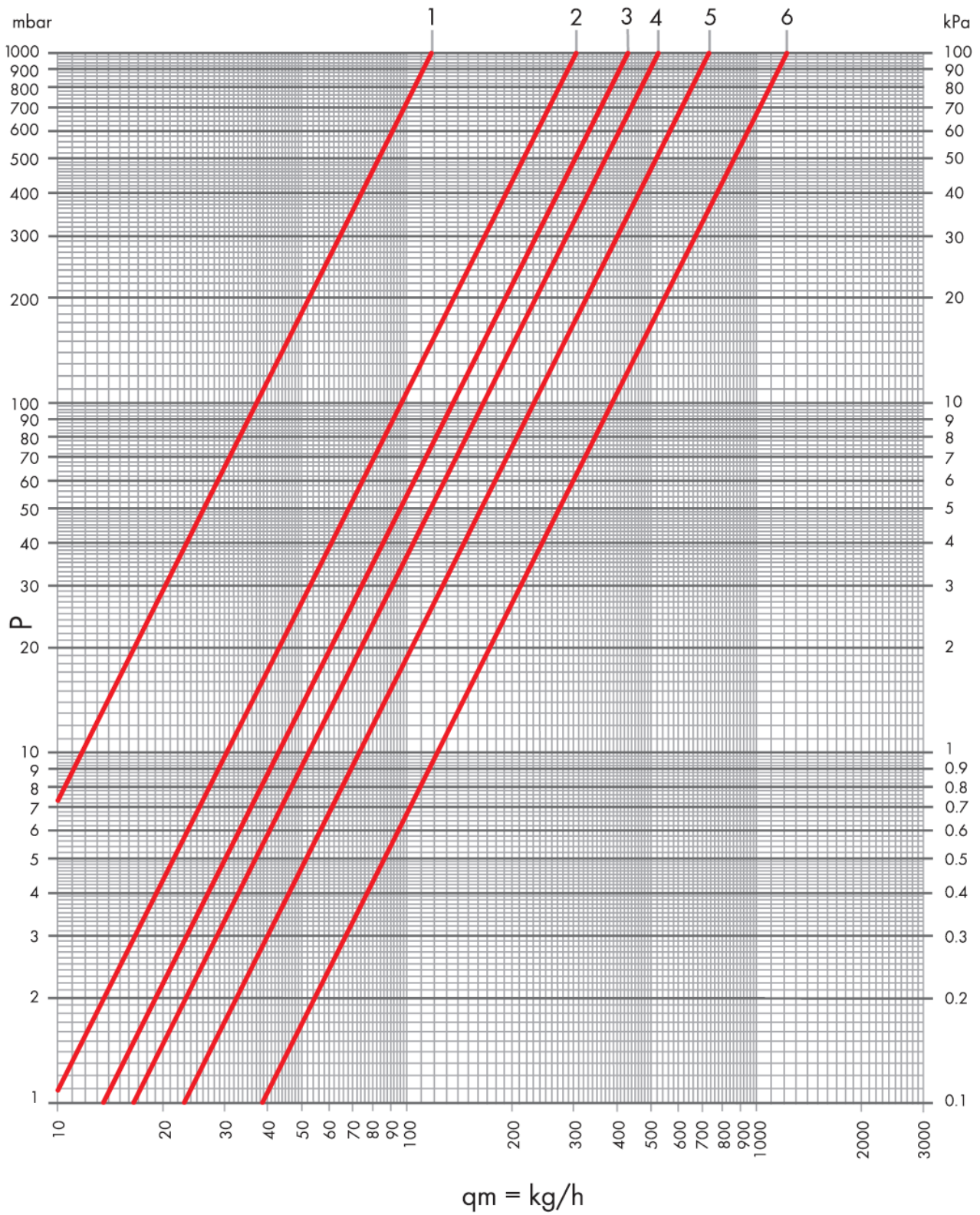

| Curve | Kv | Kv Δt 1°C | Kv Δt 2°C | Items |
|-------|------|-------------------|-------------------|-------------------------------|
| 1 | 0.12 | 0.10 | 0.11 | DN10 and DN15 straight valves |
| 2 | 0.30 | 0.20 | 0.25 | |
| 3 | 0.43 | 0.24 | 0.36 | |
| 4 | 0.52 | 0.24 | 0.37 | |
| 5 | 0.72 | 0.24 | 0.40 | |
| 6 | 1.21 | 0.29 | 0.49 | |

Hydraulic Characteristics

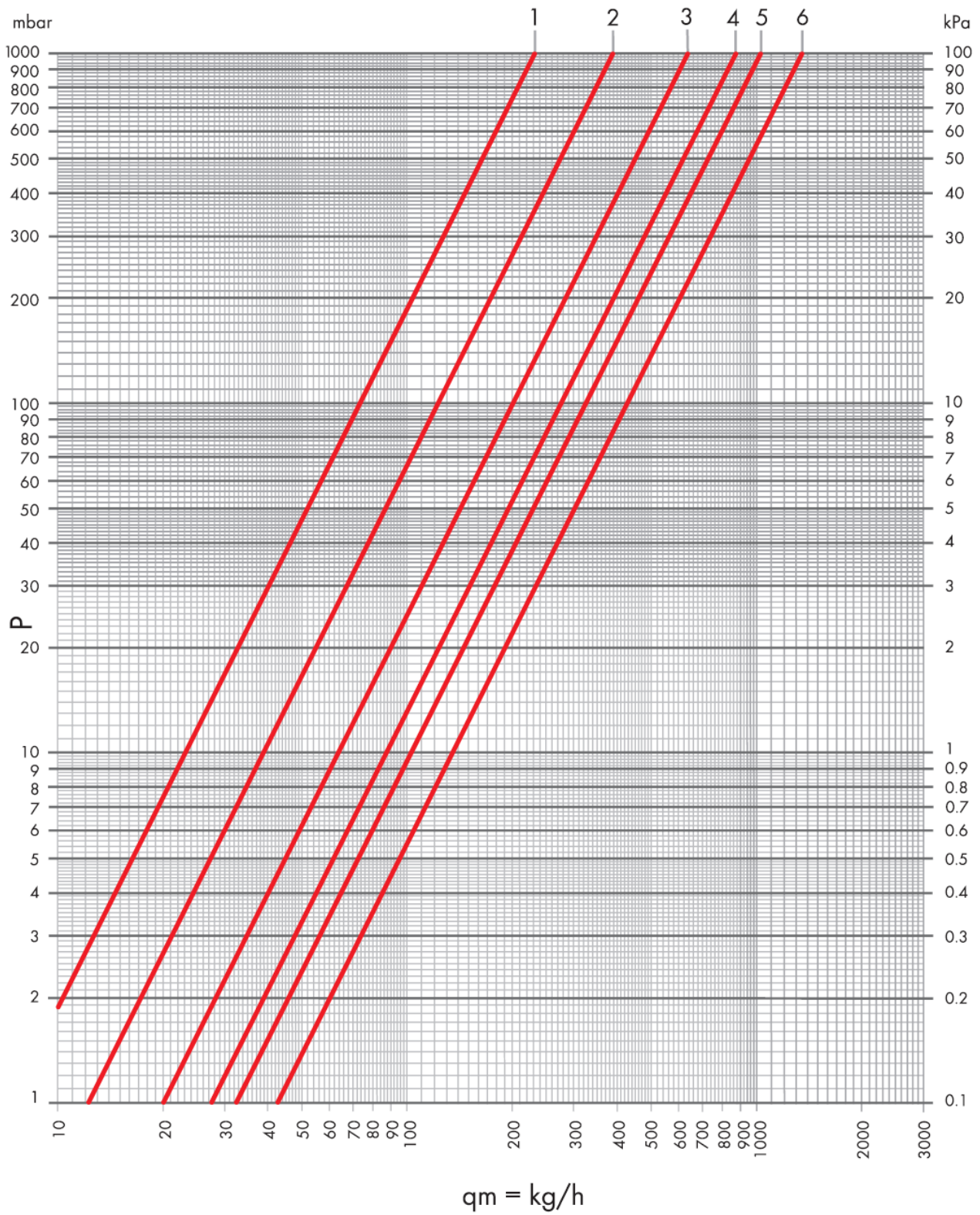

| Curve | Kv | Kv Δt 1°C | Kv Δt 2°C | Items |
|-------|------|-------------------|-------------------|----------------------|
| 1 | 0.23 | 0.16 | 0.19 | DN20 straight valves |
| 2 | 0.39 | 0.22 | 0.25 | |
| 3 | 0.63 | 0.25 | 0.36 | |
| 4 | 0.87 | 0.29 | 0.41 | |
| 5 | 1.02 | 0.30 | 0.50 | |
| 6 | 1.34 | 0.31 | 0.52 | |

Hydraulic Characteristics

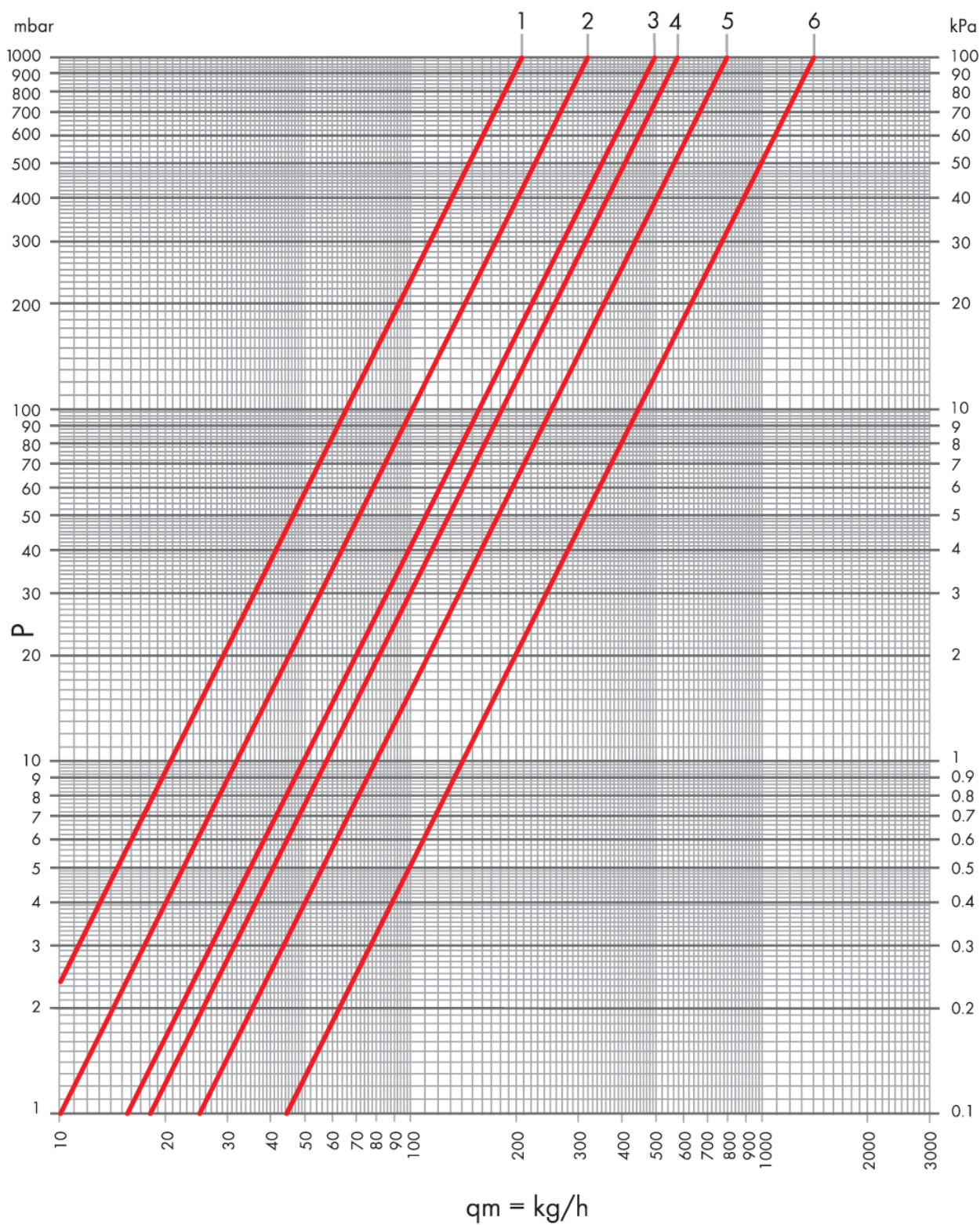

| Curve | Kv | Kv Δt 1°C | Kv Δt 2°C | Items |
|-------|------|-------------------|-------------------|----------------------------|
| 1 | 0.21 | 0.15 | 0.19 | DN10 and DN15 angle valves |
| 2 | 0.32 | 0.22 | 0.25 | |
| 3 | 0.49 | 0.24 | 0.36 | |
| 4 | 0.57 | 0.24 | 0.37 | |
| 5 | 0.79 | 0.24 | 0.40 | |
| 6 | 1.39 | 0.32 | 0.55 | |

Hydraulic Characteristics

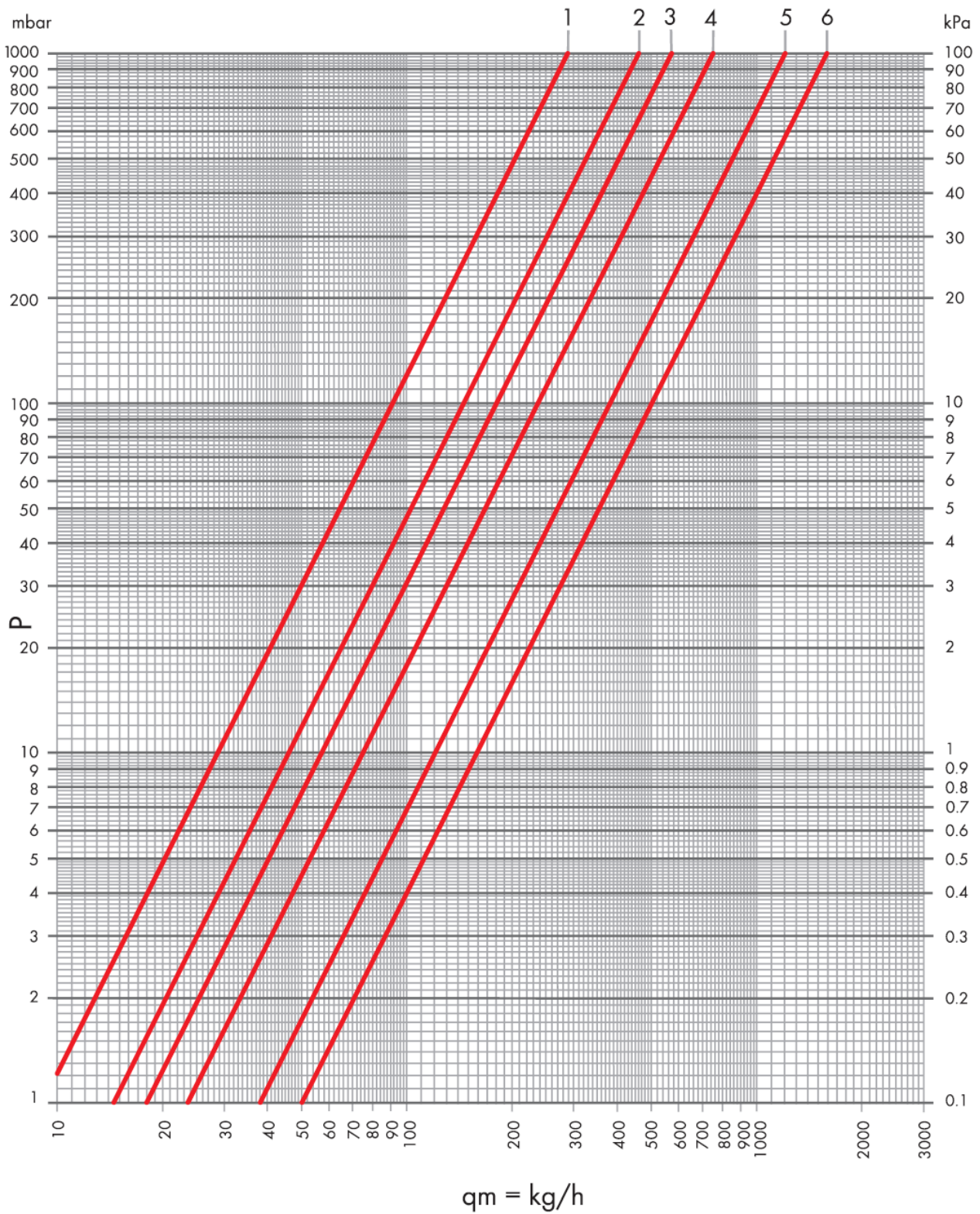

| Curve | Kv | Kv Δt 1°C | Kv Δt 2°C | Items |
|-------|------|-------------------|-------------------|-------------------|
| 1 | 0.29 | 0.15 | 0.19 | DN20 angle valves |
| 2 | 0.49 | 0.20 | 0.25 | |
| 3 | 0.57 | 0.24 | 0.36 | |
| 4 | 0.75 | 0.26 | 0.41 | |
| 5 | 1.20 | 0.31 | 0.55 | |
| 6 | 1.58 | 0.32 | 0.56 | |

Working Instructions

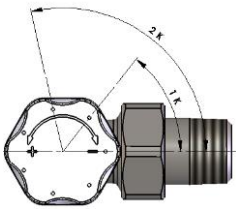

- **PROTECTION CAP:** Protects the thread during installation and allows for full closing of the valve. It enables to calibrate the nominal lift as follows:
 - Turn the cap until the valve is completely closed without forcing;
 - Draw a reference line on the valve body corresponding with one of the cap's notches;
 - Unplug the cap for two notches.



- **STEM SEALING:** The tightening device can be easily replaced without draining the system:
 - Unscrew the hexagonal collar by means of a 13 mm wrench;



- Remove the O-ring "A", clean the stainless steel stem and insert a new O-ring "A";
- Screw the collar tightly back.

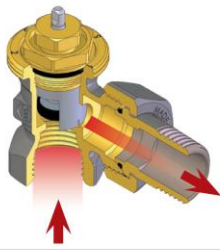
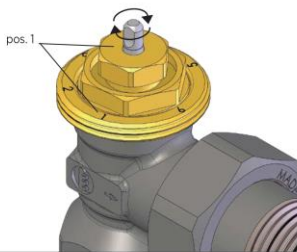

- **FLOW RATE ADJUSTMENT:** To set the maximum flow rate:
 - Align the reference mark "B" on the stainless steel stem with one of the positions printed on the valve body.

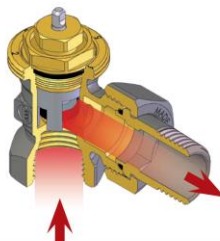
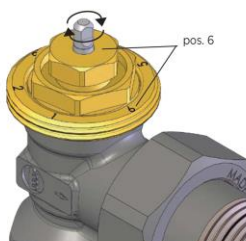

- **WARNING:** Once the system has been leak tested, please relieve the pressure. A differential pressure over 1 bar between the inlet and the outlet of the valve may cause the sealing O-ring to be expelled.

Item Specifications

RD 201

Straight radiator valve, thermostatically or electronically controlled with white ABS protection cap. ISO 228/1 3/8"F, 1/2"F and 3/4"F connection for iron pipe. Radiator connection prefitted with peroxide cured EPDM O-ring, DIN 2999 3/8"M, 1/2"M and 3/4"M conical thread. Valve body in chrome-plated CW617N brass. Double peroxide cured EPDM O-ring on the AISI 316 stainless steel stem. Max. working temperature 120 °C, max. pressure 10 bar, differential pressure 1 bar.

RS 202

Angle radiator valve, thermostatically or electronically controlled with white ABS protection cap. ISO 228/1 3/8"F, 1/2"F and 3/4"F connection for iron pipe. Radiator connection prefitted with peroxide cured EPDM O-ring, DIN 2999 3/8"M, 1/2"M and 3/4"M conical thread. Valve body in chrome-plated CW617N brass. Double peroxide cured EPDM O-ring on the AISI 316 stainless steel stem. Max. working temperature 120 °C, max. pressure 10 bar, differential pressure 1 bar.

RD 205

Straight radiator valve, thermostatically or electronically controlled with white ABS protection cap. ISO 228/1 3/8"F, 1/2"F and 3/4"F connection for iron pipe. 3/8"M, 1/2"M and 3/4"M radiator connection prefitted with peroxide cured EPDM O-ring, cylindrical thread and O-ring. Valve body in chrome-plated CW617N brass. Double peroxide cured EPDM O-ring on the AISI 316 stainless steel stem. Max. working temperature 120 °C, max. pressure 10 bar, differential pressure 1 bar.

RS 206

Angle radiator valve, thermostatically or electronically controlled with white ABS protection cap. ISO 228/1 3/8"F, 1/2"F and 3/4"F connection for iron pipe. 3/8"M, 1/2"M and 3/4"M radiator connection prefitted with peroxide cured EPDM O-ring, cylindrical thread and O-ring. Valve body in chrome-plated CW617N brass. Double peroxide cured EPDM O-ring on the AISI 316 stainless steel stem. Max. working temperature 120 °C, max. pressure 10 bar, differential pressure 1 bar.

RD 211

Straight radiator valve, thermostatically or electronically controlled with white ABS protection cap. Connection for copper, plastic and multilayer pipe W24x19. Radiator connection prefitted with peroxide cured EPDM O-ring, DIN 2999 3/8"M and 1/2"M conical thread. Valve body in chrome-plated CW617N brass. Double peroxide cured EPDM O-ring on the AISI 316 stainless steel stem. Max. working temperature 120 °C, max. pressure 10 bar, differential pressure 1 bar.

RS 212

Angle radiator valve, thermostatically or electronically controlled with white ABS protection cap. Connection for copper, plastic and multilayer pipe W24x19. Radiator connection prefitted with peroxide cured EPDM O-ring, DIN 2999 3/8"M and 1/2"M conical thread. Valve body in chrome-plated CW617N brass. Double peroxide cured EPDM O-ring on the AISI 316 stainless steel stem. Max. working temperature 120 °C, max. pressure 10 bar, differential pressure 1 bar.

RD 208

Straight radiator valve, thermostatically or electronically controlled with white ABS protection cap. Connection for copper, plastic and multilayer pipe W24x19. 3/8"M, 1/2"M and 3/4"M radiator connection prefitted with peroxide cured EPDM O-ring, cylindrical thread and O-ring. Valve body in chrome-plated CW617N brass. Double peroxide cured EPDM O-ring on the AISI 316 stainless steel stem. Max. working temperature 120 °C, max. pressure 10 bar, differential pressure 1 bar.

RS 209

Angle radiator valve, thermostatically or electronically controlled with white ABS protection cap. Connection for copper, plastic and multilayer pipe W24x19. 3/8"M, 1/2"M and 3/4"M radiator connection prefitted with peroxide cured EPDM O-ring, cylindrical thread and O-ring. Valve body in chrome-plated CW617N brass. Double peroxide cured EPDM O-ring on the AISI 316 stainless steel stem. Max. working temperature 120 °C, max. pressure 10 bar, differential pressure 1 bar.

RD 211/A

Straight radiator valve, thermostatically or electronically controlled with white ABS protection cap. Connection for copper, plastic and multilayer pipe 3/4"M Eurokonus. Radiator connection prefitted with peroxide cured EPDM O-ring, DIN 2999 3/8"M and 1/2"M conical thread. Valve body in chrome-plated CW617N brass. Double peroxide cured EPDM O-ring on the AISI 316 stainless steel stem. Max. working temperature 120 °C, max. pressure 10 bar, differential pressure 1 bar.

RS 212/A

Angle radiator valve, thermostatically or electronically controlled with white ABS protection cap. Connection for copper, plastic and multilayer pipe 3/4"M Eurokonus. Radiator connection prefitted with peroxide cured EPDM O-ring, DIN 2999 3/8"M and 1/2"M conical thread. Valve body in chrome-plated CW617N brass. Double peroxide cured EPDM O-ring on the AISI 316 stainless steel stem. Max. working temperature 120 °C, max. pressure 10 bar, differential pressure 1 bar.

RD 208/A

Straight radiator valve, thermostatically or electronically controlled with white ABS protection cap. Connection for copper, plastic and multilayer pipe 3/4"M Eurokonus. 3/8"M, 1/2"M and 3/4"M radiator connection prefitted with peroxide cured EPDM O-ring, cylindrical thread and O-ring. Valve body in chrome-plated CW617N brass. Double peroxide cured EPDM O-ring on the AISI

316 stainless steel stem. Max. working temperature 120 °C, max. pressure 10 bar, differential pressure 1 bar.

RS 209/A

Angle radiator valve, thermostatically or electronically controlled with white ABS protection cap. Connection for copper, plastic and multilayer pipe 3/4" M Eurokonus. 3/8" M, 1/2" M and 3/4" M radiator connection prefitted with peroxide cured EPDM O-ring, cylindrical thread and O-ring. Valve body in chrome-plated CW617N brass. Double peroxide cured EPDM O-ring on the AISI 316 stainless steel stem. Max. working temperature 120 °C, max. pressure 10 bar, differential pressure 1 bar.

RD 2501

Straight radiator valve, thermostatically or electronically controlled, with anti-loosening white ABS manual control knob. ISO 228/1 3/8" F, 1/2" F and 3/4" F connection for iron pipe. Radiator connection prefitted with peroxide cured EPDM O-ring, DIN 2999 3/8" M, 1/2" M and 3/4" M conical thread. Valve body in chrome-plated CW617N brass. Double peroxide cured EPDM O-ring on the AISI 316 stainless steel stem. Max. working temperature 120 °C, max. pressure 10 bar, differential pressure 1 bar.

RS 2502

Angle radiator valve, thermostatically or electronically controlled, with anti-loosening white ABS manual control knob. ISO 228/1 3/8" F, 1/2" F and 3/4" F connection for iron pipe. Radiator connection prefitted with peroxide cured EPDM O-ring, DIN 2999 3/8" M, 1/2" M and 3/4" M conical thread. Valve body in chrome-plated CW617N brass. Double peroxide cured EPDM O-ring on the AISI 316 stainless steel stem. Max. working temperature 120 °C, max. pressure 10 bar, differential pressure 1 bar.

RD 2505

Straight radiator valve, thermostatically or electronically controlled, with anti-loosening white ABS manual control knob. ISO 228/1 3/8" F and 1/2" F connection for iron pipe. 3/8" M, 1/2" M and 3/4" M radiator connection prefitted with peroxide cured EPDM O-ring, cylindrical thread and O-ring. Valve body in chrome-plated CW617N brass. Double peroxide cured EPDM O-ring on the AISI 316 stainless steel stem. Max. working temperature 120 °C, max. pressure 10 bar, differential pressure 1 bar.

RS 2506

Angle radiator valve, thermostatically or electronically controlled, with anti-loosening white ABS manual control knob. ISO 228/1 3/8" F and 1/2" F connection for iron pipe. 3/8" M, 1/2" M and 3/4" M radiator connection prefitted with peroxide cured EPDM O-ring, cylindrical thread and O-ring. Valve body in chrome-plated CW617N brass. Double peroxide cured EPDM O-ring on the AISI 316 stainless steel stem. Max. working temperature 120 °C, max. pressure 10 bar, differential pressure 1 bar.

RD 2511

Straight radiator valve, thermostatically or electronically controlled, with anti-loosening white ABS manual control knob. Connection for copper, plastic and multilayer pipe W24x19. Radiator connection prefitted with peroxide cured EPDM O-ring, DIN 2999 3/8" M and 1/2" M conical thread. Valve body in chrome-plated CW617N brass. Double peroxide cured EPDM O-ring on the AISI 316 stainless steel stem. Max. working temperature 120 °C, max. pressure 10 bar, differential pressure 1 bar.

RS 2512

Angle radiator valve, thermostatically or electronically controlled, with anti-loosening white ABS manual control knob. Connection for copper, plastic and multilayer pipe W24x19. Radiator connection prefitted with peroxide cured EPDM O-ring, DIN 2999 3/8" M and 1/2" M conical thread. Valve body in chrome-plated CW617N brass. Double peroxide cured EPDM O-ring on the AISI 316 stainless steel stem. Max. working temperature 120 °C, max. pressure 10 bar, differential pressure 1 bar.

RD 2508

Straight radiator valve, thermostatically or electronically controlled, with anti-loosening white ABS manual control knob. Connection for copper, plastic and multilayer pipe W24x19. 3/8" M, 1/2" M and 3/4" M radiator connection prefitted with peroxide cured EPDM O-ring, cylindrical thread and O-ring. Valve body in chrome-plated CW617N brass. Double peroxide cured EPDM O-ring on the AISI 316 stainless steel stem. Max. working temperature 120 °C, max. pressure 10 bar, differential pressure 1 bar.

RS 2509

Angle radiator valve, thermostatically or electronically controlled, with anti-loosening white ABS manual control knob. Connection for copper, plastic and multilayer pipe W24x19. 3/8" M, 1/2" M and 3/4" M radiator connection prefitted with peroxide cured EPDM O-ring, cylindrical thread and O-ring. Valve body in chrome-plated CW617N brass. Double peroxide cured EPDM O-ring on the AISI 316 stainless steel stem. Max. working temperature 120 °C, max. pressure 10 bar, differential pressure 1 bar.

RD 2508/A

Straight radiator valve, thermostatically or electronically controlled, with anti-loosening white ABS manual control knob. Connection for copper, plastic and multilayer pipe 3/4" M Eurokonus. 3/8" M, 1/2" M and 3/4" M radiator connection prefitted with peroxide cured EPDM O-ring, cylindrical thread and O-ring. Valve body in chrome-plated CW617N brass. Double peroxide cured EPDM O-ring on the AISI 316 stainless steel stem. Max. working temperature 120 °C, max. pressure 10 bar, differential pressure 1 bar.

RS 2509/A

Angle radiator valve, thermostatically or electronically controlled, with anti-loosening white ABS manual control knob. Connection for copper, plastic and multilayer pipe 3/4" M Eurokonus. 3/8" M, 1/2" M and 3/4" M radiator connection prefitted with peroxide cured EPDM O-ring, cylindrical thread and O-ring. Valve body in chrome-plated CW617N brass. Double peroxide cured EPDM O-ring on the AISI 316 stainless steel stem. Max. working temperature 120 °C, max. pressure 10 bar, differential

pressure 1 bar.

RD 2511/A

Straight radiator valve, thermostatically or electronically controlled, with anti-loosening white ABS manual control knob. Connection for copper, plastic and multilayer pipe 3/4" M Eurokonus. Radiator connection prefitted with peroxide cured EPDM O-ring, DIN 2999 1/2" M conical thread. Valve body in chrome-plated CW617N brass. Double peroxide cured EPDM O-ring on the AISI 316 stainless steel stem. Max. working temperature 120 °C, max. pressure 10 bar, differential pressure 1 bar.

RS 2512/A

Angle radiator valve, thermostatically or electronically controlled, with anti-loosening white ABS manual control knob. Connection for copper, plastic and multilayer pipe 3/4" M Eurokonus. Radiator connection prefitted with peroxide cured EPDM O-ring, DIN 2999 3/8" M and 1/2" M conical thread. Valve body in chrome-plated CW617N brass. Double peroxide cured EPDM O-ring on the AISI 316 stainless steel stem. Max. working temperature 120 °C, max. pressure 10 bar, differential pressure 1 bar.

M 320

Reverse angle radiator valve, thermostatically or electronically controlled with white ABS protection cap. Connection for copper, plastic and multilayer pipe W24x19. Radiator connection prefitted with peroxide cured EPDM O-ring, DIN 2999 1/2" M conical thread. Valve body in chrome-plated CW617N brass. Double peroxide cured EPDM O-ring on the AISI 316 stainless steel stem. Max. working temperature 120 °C, max. pressure 10 bar, differential pressure 1 bar.

M 320/A

Reverse angle radiator valve, thermostatically or electronically controlled with white ABS protection cap. Connection for copper, plastic and multilayer pipe 3/4" M Eurokonus. Radiator connection prefitted with peroxide cured EPDM O-ring, DIN 2999 1/2" M conical thread. Valve body in chrome-plated CW617N brass. Double peroxide cured EPDM O-ring on the AISI 316 stainless steel stem. Max. working temperature 120 °C, max. pressure 10 bar, differential pressure 1 bar.

M 330

Reverse angle radiator valve, thermostatically or electronically controlled, with anti-loosening white ABS manual control knob. Connection for copper, plastic and multilayer pipe W24x19. Radiator connection prefitted with peroxide cured EPDM O-ring, DIN 2999 1/2" M conical thread. Valve body in chrome-plated CW617N brass. Double peroxide cured EPDM O-ring on the AISI 316 stainless steel stem. Max. working temperature 120 °C, max. pressure 10 bar, differential pressure 1 bar.

M 330/A

Reverse angle radiator valve, thermostatically or electronically controlled, with anti-loosening white ABS manual control knob. Connection for copper, plastic and multilayer pipe 3/4" M Eurokonus. Radiator connection prefitted with peroxide cured EPDM O-ring, DIN 2999 1/2" M conical thread. Valve body in chrome-plated CW617N brass. Double peroxide cured EPDM O-ring on the AISI 316 stainless steel stem. Max. working temperature 120 °C, max. pressure 10 bar, differential pressure 1 bar.

M 322

Reverse angle radiator valve, thermostatically or electronically controlled with white ABS protection cap. ISO 228/1 1/2" F connection for iron pipe. Radiator connection prefitted with peroxide cured EPDM O-ring, DIN 2999 1/2" M conical thread. Valve body in chrome-plated CW617N brass. Double peroxide cured EPDM O-ring on the AISI 316 stainless steel stem. Max. working temperature 120 °C, max. pressure 10 bar, differential pressure 1 bar.

M 332

Reverse angle radiator valve, thermostatically or electronically controlled, with anti-loosening white ABS manual control knob. ISO 228/1 1/2" F connection for iron pipe. Radiator connection prefitted with peroxide cured EPDM O-ring, DIN 2999 1/2" M conical thread. Valve body in chrome-plated CW617N brass. Double peroxide cured EPDM O-ring on the AISI 316 stainless steel stem. Max. working temperature 120 °C, max. pressure 10 bar, differential pressure 1 bar.



Luxor S.p.A.

Sede amministrativa, stabilimento e uffici commerciali:

Administrative office, factory and commercial office:

Tel.: 030-9961161 – Fax: 030-9961165

info@luxor.it – www.luxor.it

via Madonnina, 94 – 25018 Montichiari - (BS) Italy

*Luxor si riserva il diritto di apportare miglioramenti e modifiche ai prodotti descritti ed ai relativi dati tecnici in qualsiasi momento e senza preavviso -
Luxor reserves the right to ameliorate and modify the above products and their technical data at any time and without notice*