

Conex | Bänninger

>B< Press Inox



 >B< Press Inox
Technical Brochure

Contents

1: General	1
1.1 Quality and Certification	
1.2 Materials	
1.3 Threads	
1.4 Black EPDM Sealing Elements	
1.5 Processing and Assembly	
1.6 Cold Bending of Stainless Steel Tubes	
1.7 Storage and Handling	
1.8 Tube Compatibility	
1.9 Electrical Continuity	
1.10 Recommended Water Velocities	
1.11 Product Guarantee	
2: Areas of Application.....	2
3: Thermal Expansion	3
3.1 Effects of Expansion	
3.2 Expansion Devices	
4: Corrosion Resistances.....	4
4.1 Internal Corrosion	
4.1.1 Disinfection and Sterilisation	
4.2 External Corrosion	
4.3 Thermal Insulation	
4.4 Connecting to other Materials	
5: Fitting Construction.....	4
5.1 Commissioning of >B< Press Inox Installations	
6: >B< Press Tools	5
6.1 >B< Press Jaws	
6.2 Maintenance	
6.3 Guarantee >B< Press to Press Connections	
6.4 Guarantee and other Manufacturers	
6.5 Compatible Press Tools	
6.5.1 Use of Tools	
7: Loss Coefficients	7
8: Installation Requirements	9
8.1 Installation Dimensions	
8.2 Tube Tolerances	
8.3 Minimum Tool Access	
9: Tube Preparation.....	11
9.1 Tube Cutting	
9.2 Tube Deburring	
10: Installation Guide	12
11: Product Range	13

1: General

>B< Press Inox is a quick and simple to install flame-free fitting, manufactured using high quality hygienic stainless steel material, suitable for multiple applications. >B< Press Inox is designed with a unique and innovative 3-point press system to ensure a leak-free, secure and permanent joint.

1.1 Quality and Certification

With over 100 years of experience in manufacturing innovative technology, Conex Bänninger operates an accredited Quality Management System to EN ISO 9001.

>B< Press Inox press fittings are tested and certified by independent national certification bodies like WRAS confirming their suitability and reliability for water use.

>B< Press Inox fittings are also certified by the following bodies:

Watermark	Australia	EMI	Hungary
DVGW	Germany	TYSK	Ukraine
Swedcert	Sweden	ITB	Poland
PZH	Poland	ACS	France
PCT	Russia		

1.2 Materials

>B< Press Inox fittings are made from solution-treated molybdenum-steel AISI 316L in accordance with EN 10088. These fittings are type tested in accordance with EN 10352 and approved for drinking water by WRAS and DVGW.

>B< Press Inox tubes are available in the material AISI 316L. The tubes correspond in properties and dimensions with the requirements of EN 10312, Series 2.

1.3 Threads

All of our >B< Press threaded fittings comply with EN 10226-1 (ISO 7-1) and are 'thread sealing' (mating conical male thread R /cylindrical female thread Rp).

1.4 Black EPDM Sealing Elements

High quality black elastomer EPDM with a hardness of 70 Shore is used for the sealing elements (O-rings) of our >B< Press Inox fittings. The sealing elements we use comply with the requirements of EN 681-1 for use within drinking water systems.

EPDM (ethylene propylene diene monomer) is a synthetic, peroxide-cured rubber. It is age, ozone and chemical resistant with high elasticity, and excellent cold and heat behaviour.

Temperature range:

Min/Max continuous operating temperature of the fittings: -35 to 110°C.

1.5 Applications

When using >B< Press Inox fitting, the application parameters in section 2 must be observed. >B< Press Inox fittings can be used with all stainless steel tubes that comply with EN 10312.

The use of different materials in a drinking water system must comply with the appropriate codes of practice. In the design and creation of pipework systems the standard engineering practices for drinking water installations must be adhered to and observed.

1.6 Cold Bending of Stainless Steel Tubes

Stainless steel tubes up to 28 mm, comply with EN 10312 Series 2. Tubes can be bent cold with suitable bending equipment, with a minimum bend radius of 3.5 times the tube diameter.

1.7 Storage and Handling

For the storage and transportation of >B< Press Inox tubes and fittings, it is advisable to leave the fittings in the packaging to conserve the lubrication of the O-rings prior to installations.

Please store in a cool and dry place to protect the fittings from contamination, damage and dirt.

1.8 Tube Compatibility

>B< Press Inox fittings can be used on stainless steel tubes manufactured in accordance with EN 10312 Series 1 and 2.

1.9 Electrical Continuity

>B< Press Inox fittings maintain earth continuity without the need for additional continuity straps.

1.10 Recommended Water Velocities

Please note the maximum allowances for water velocities are per the relevant national standards and codes, which includes EN 806-5. For more details please contact the technical team: technical@ibpgroup.com.

1.11 Product Guarantee

When professionally installed and used in accordance with our guidelines, >B< Press Inox fittings supplied by Conex Bänninger are guaranteed against manufacturing defects for 25 years from the date of first purchase. Any alleged defects must be reported to Conex Universal Ltd within one month of the first occurrence, clearly setting out the nature of the claim.

The guarantee is limited to the repair or replacement of defective fittings at the discretion of Conex Universal Ltd and the company reserves the right to inspect and test the alleged defects. This guarantee provided by Conex Universal Ltd does not affect your statutory rights.

2: Areas of Application

>B< Press Inox fittings are suitable for use in the following applications: hot and cold drinking water, heating, cooling and rainwater systems. The fittings are also suitable for low pressure steam, compressed air (oil free) systems, organic and inorganic acids, silicon oils, grease and polar solvents such as alcohols and ketones.

Application	Flow Medium Temperature	Pressure bar	Temp °C
Hot and cold water installations	General installations for hot and cold potable and non potable water outside EN specified requirements	16	-35 to +110
Drinking water installations EN 806 and EN 1988	Drinking water in accordance with the drinking water ordinance	10	95
		16	25
Hot water heaters EN 12828	Heating water	6	110
Local and district heating tubes EN 4747	Heating and district heating water	10	110
Thermal solar systems with permanent operating temperatures ≤ 110 °C EN 12975 / 12976	Water and water-glycol mixtures Mixing ratio max. 50/50%	6	-35 to 110
Water-based air conditioning systems	Water and water-glycol mixtures Mixing ratio max. 50/50%	6	-10
Rainwater harvesting systems EN 1989	Rainwater from cisterns	10	25
Oil-free compressed air	Compressed air classes 1 - 3 in accordance with ISO 8573-1	10	25
Industrial and process water	Treated, softened, partially and fully desalinated water	10	95
		16	25
Vacuum lines for non-medical purposes	n/a	-0,8	Ambient
Construction site test pressure	Water with $6.5 \leq \text{pH} \leq 9.5$	20	20

Not suitable for:

Aromatic, aliphatic and chlorinated hydrocarbons, turpentine, petroleum and mineral oils.

For applications outside those stated in the table above, please contact the technical department: technical@ibpgroup.com.



3: Thermal Expansion

3.1 Effects of Expansion

The coefficient of linear expansion for stainless steel is 16.0×10 per $^{\circ}\text{C}$. For example, a 10 metre length of stainless steel tube, irrespective of its size, wall thickness or temper, will increase in length by 9.6 mm with a temperature rise of 60°C . Tubes installed on hot water services must be free to accommodate this expansion; otherwise stresses will build up in the pipework, which may lead to joints being pulled apart and/or tubes fracturing. Clearly the magnitude and frequency of such changes in length will determine the life of the joint or failure of the tube.

Table 3.2 shows the amount of tube expansion for a given temperature rise. In the case of tube in domestic hot water and heating installations the limited size of rooms and hence straight tube runs, together with the many bends and offsets that normally occur, will result in thermal movement being accommodated automatically. However where long straight tube runs, exceeding 10 metres are encountered, allowance for expansion should be made.

A quick, economic and effective way of accommodating thermal expansion is to simply incorporate the horseshoe or compensating bend to the system design.

3.2 Expansion Devices

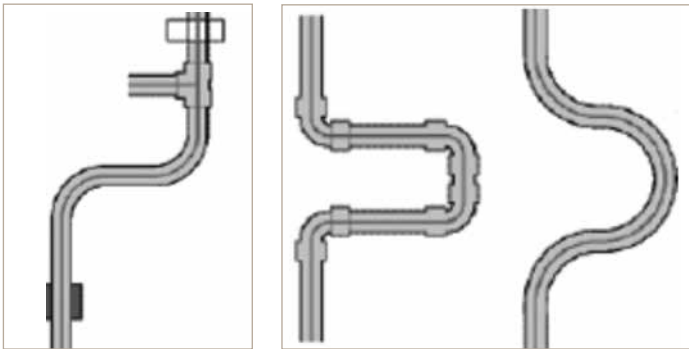

By change of direction

Horseshoe or compensating bend

Where stainless steel tubes pass through walls, floors and ceilings, they should be able to move as a result of expansion and contraction. This can be arranged by passing the tube through a sleeve or length of larger diameter tube fixed through the whole thickness of the wall, floor or ceiling, or by means of flexible joints on either side of the wall.

Short stubs to and from radiators, connected to relatively long straight runs should also be avoided. This can usually be achieved by introducing an expansion loop, thereby increasing the length of pipework fixed between the flow/return legs and the radiator connection. However, expansion accommodation techniques such as the use of loops and horseshoes may not be sufficient to accommodate large expansions and in such cases the use of the bellow type couplers may be necessary.

Thermal expansion (mm) of stainless steel tube as a function of tube length and temperature difference.

The table below shows the increase in length due to thermal expansion as a function of change in temperature Δt and the length of the tube at the lower temperature, irrespective of temper or wall thickness.

Tube Length m	Temperature difference Δt $^{\circ}\text{C}$							
	$\Delta t=30^{\circ}$	$\Delta t=40^{\circ}$	$\Delta t=50^{\circ}$	$\Delta t=60^{\circ}$	$\Delta t=70^{\circ}$	$\Delta t=80^{\circ}$	$\Delta t=90^{\circ}$	$\Delta t=100^{\circ}$
0.1	0.05	0.06	0.08	0.10	0.11	0.13	0.14	0.16
0.2	0.10	0.13	0.16	0.19	0.22	0.26	0.30	0.32
0.3	0.14	0.20	0.24	0.30	0.34	0.40	0.43	0.50
0.4	0.20	0.26	0.32	0.40	0.45	0.50	0.60	0.64
0.5	0.24	0.30	0.40	0.50	0.56	0.64	0.72	0.80
0.6	0.30	0.40	0.50	0.58	0.67	0.77	0.86	0.96
0.7	0.34	0.45	0.56	0.67	0.80	0.90	1.01	1.12
0.8	0.40	0.50	0.64	0.77	0.90	1.02	1.15	1.30
0.9	0.43	0.57	0.72	0.86	1.01	1.15	1.30	1.44
1.0	0.50	0.64	0.80	0.96	1.12	1.30	1.44	1.60
2.0	0.96	1.30	1.60	1.92	2.24	2.60	2.90	3.20
3.0	1.44	1.92	2.40	2.90	3.40	3.84	4.32	4.80
4.0	1.92	2.60	3.20	3.80	4.50	5.12	5.76	6.40
5.0	2.40	3.20	4.00	4.80	5.60	6.40	7.20	8.00
10.0	4.80	6.40	8.00	9.60	11.20	12.80	14.40	16.00
15.0	0.72	9.60	12.00	14.40	16.80	19.20	21.60	24.00
20.0	0.96	12.80	16.00	19.20	22.40	25.60	28.80	32.00
25.0	12.00	16.00	20.00	24.00	28.00	32.00	36.00	40.00

4. Corrosion Resistance

4.1 Internal Corrosion

Within a stainless steel pipework system a passive layer, mostly formed from chromic oxide is created upon contact with oxygen or oxygenated water (i.e. drinking water). This layer restricts corrosion from occurring and provides high levels of hygiene, durability and water quality.

If there are chloride levels above those deemed acceptable, a breakdown of the passive layer may occur allowing corrosion to occur in the form of, pitting, crevice or stress corrosion. The established view is that crevice corrosion rarely occurs on grade 316 steel where the concentrations of chloride are under 1000ppm in supply and waste water systems.

It has also been proved that crevice and pitting corrosion increases with temperature, however for drinking water systems everyday temperatures and chloride levels should not be a problem. Please note the UK guidelines. On the other hand borehole water may have increased levels of chlorine meaning more care should be taken to make sure levels are within the tolerable range.

4.1.1 Disinfection and Sterilisation

For the sterilisation process, chlorine of concentrations up to 25ppm during a 24 hour period is acceptable, providing that the lines are comprehensively flushed with fresh water and that residual chlorine is restricted to < 1ppm. It is recommended that this is verified by analysis.

4.2 External Corrosion

External corrosion of stainless steel systems is likely to occur when exposed to high levels of chloride. >B< Press Inox fittings should not be installed in this situation. However, if there are parts of the system where this is unavoidable, appropriate precautions must be taken to minimise the risk.

4.3 Thermal Insulation

The thermal insulations of tubes should be implemented in accordance with national codes and standards including BS 5970.

4.4 Connecting to other Materials

Stainless steel, copper and copper alloys can easily be combined without the risk of corrosion. Please note carbon steel should not be directly connected to stainless steel as this will cause corrosion. A spacer connector of brass material should be used to separate the two dissimilar materials by at least 50 mm. Flow of water should be in the direction of carbon steel to stainless steel and not visa versa.

5. Fitting Construction

The >B< Press Inox design has the advantage of a 3-point press profile; two hexagonal mechanical presses on either side of bead, and containing the O-ring. When pressure is exerted through the press tool, the O-ring material compresses itself to form a permanent, leak-proof joint, as a part the cold forming process.

This 3-point press feature enables a quick and safe installation process. To fit correctly it is important to ensure that the tube is parallel to the fitting before contact with the O-ring. This reduces the chance of damage to the O-ring during assembly.

All our >B< Press Inox fittings have a 'unique pressing indicator' that detects un-pressed connections.

>B< Press Inox fittings are specifically designed with a high-quality EPDM seal, with a specially section in two positions, which allows leakage if the joint has not been pressed. The joint will leak at a pressure between 0.1 to 6.0 bar. Any unpressed joints can be identified during the test phase and corrected saving valuable time. There is no need to drain down as the pressing operation can be carried out whilst the water is still in the system. Always ensure the tube is fully inserted to the stop before pressing. When the fitting is pressed, the O-ring material compresses itself to form a permanent, leak free joint.

For a guaranteed leak free joint please use our approved and recommended pressing jaws. See section 6.5.

>B< Press Inox fittings are installed with a mechanical press tool and a compatible >B< profile jaw. The Force is exerted through the press tool closing the jaw to make a permanent joint.

5.1 Commissioning of >B< Press Inox Installations

Chemical disinfection and flushing of >B< Press Inox systems should be carried out in accordance to EN 806-4 guidelines.

Stainless steel tubes can be disinfected with hydrogen peroxide H₂O₂, although disinfection with chlorine is possible providing correct guidelines are used.

Stainless steel pipework must be protected from external contact with chloride-containing building materials and other aggressive medium. In such cases, a subsequent corrosion protection in accordance with EN 12068 should be provided. Please note it is advised that corrosion protection binding and/or exposure to class A or B heat-shrinkable tubing guidelines must be adhered to.

If in doubt please contact our technical department: technical@ibpgroup.com.



6. >B< Press Tools

Please refer to our approved jaw list in section 6.5.

6.1 >B< Press Jaws

There are various press and jaws that have been tested for use when installing >B< Press fitting system. Please note we offer press jaws in nominal sizes from 15 to 54 mm. Please see approved press jaws listed in sections 6.5.

6.2 Maintenance Instructions

The maintenance of press machines and jaws approved by Conex Bänninger must be carried out at least once a year or at the latest after approx. 10,000 pressings by an authorised service centre.

The regular maintenance, care and cleaning of press jaws must be done by the user. Press jaws must always be free of damage or deformation. The inner pressing contour of the jaw must always be kept free of dirt and debris. When necessary, the jaws can be cleaned with a brush or cleaning cloth and non-corrosive solvents such as methylated spirit.

6.3 Guarantee >B< Press to Press Connections

In principle, product guarantee for >B< Press Inox products are subject to expert and correct installations procedure in line with the installation instructions. For more details about the guarantee please visit www.conexbanninger.com.

The use of Stainless press connectors from other manufacturers in the same installation does not affect the warranty of our fittings.

6.4 Guarantee and other Manufacturers

If press products from other manufacturers are used in the same installation with Stainless steel tubes, owners of these fittings are responsible for their products according to their specifications. Please contact these manufacturers directly for more details.

Direct connection of press fittings with other products from different manufacturers is subject to conditions. In case of damage, an assessment would have to be made to confirm the cause of the damage.



6.5 Compatible Press Tools

Size and Type	Press Jaw	Klauke		Rems	Rothenberger	Viega		RIDGID	Novopress* Milwaukee* Conel V-PB2
		Profile	KSP4 P77267	SSK (42 & 54 Only)	V/V45	V/SV	SOM	PT 2	V
15 - 54 mm	Manufacturer	Press Machine							
	Klauke	UP2EL14	✓	✓	✓	✓	✓	✓	✓
	Klauke	UAP2/UNP2	✓	✓	✓	✓	✓	✓	✓
	Klauke	UAP3L/UAP4L	✓	✓	✓	✓	✓	✓	✓
	Rems	Power-Press	✓	✓	✓	✓	✓	✓	No
	Rems	Akku-Press	✓	✓	✓	✓	✓	✓	No
	Rothenberger	Romax 3000	✓	✓	✓	✓	✓	✓	✓
	Rothenberger	Romax Pressliner/Eco	✓	✓	✓	✓	✓	✓	✓
	Rothenberger	Romax AC-Eco	✓	✓	✓	✓	✓	✓	✓
	Viega	Typ 2	✓	✓	✓	✓	✓	✓	✓
	Viega	PT3-AH/EH/H	✓	✓	✓	✓	✓	✓	✓
	Viega	Akku-Presshandy	✓	✓	✓	✓	✓	✓	✓
	Viega	Pressgun 5/4 B/E	✓	✓	✓	✓	✓	✓	✓
	Conel	PM 2	✓	✓	✓	✓	✓	✓	✓
	Novopress	EFP1 (as of serial nr.6000)	✓	✓	✓	✓	✓	✓	✓
	Novopress	EFP2	✓	✓	✓	✓	✓	✓	✓
	Novopress	ACO1/ECO1	✓	✓	✓	✓	✓	✓	✓
	Novopress	ACO/ECO/EFP/AFP201/202	✓	✓	✓	✓	✓	✓	✓
	Novopress	ACO/ECO/EFP203	✓	✓	✓	✓	✓	✓	✓
	Milwaukee	M18 HPT/BLHPT	✓	✓	✓	✓	✓	✓	✓
	Geberit	PWH 75	✓	✓	✓	✓	✓	✓	✓
	Ridgid	RP 330/340-B/-C	✓	✓	✓	✓	✓	✓	✓
			IBP		Rems	Rothenberger	Viega	RIDGID	Conel Novopress* Milwaukee*
15 - 35 mm			KSP4 P77282		Mini V/V45	Compact V/SV	Picco	Compact V	V-PB1
	Klauke	MAP1	✓ ≤ 28		No	No	No	No	No
	Klauke	MAP2L	✓ ≤ 28		No	No	No	No	No
	Rems	Mini-Press ACC	No		✓	No	No	No	No
	Rothenberger	Romax Compact	No		No	✓ ≤ 28	No	No	✓ ≤ 28
	Ridgid	100-B / RP 210-B	No		No	No	No	✓	No
	Viega	Picco/Pressgun Picco	No		No	No	✓	No	No
	Conel	PM1	No		No	✓ ≤ 28	No	No	✓
	Novopress	AFP101/ACO102	No		No	✓ ≤ 28	No	No	✓
	Milwaukee	M12 HPT	No		No	✓ ≤ 28	No	No	✓

! Always read the manufacturers instruction book before using press machines and jaws.













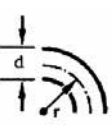

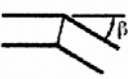
* NOVOPRESS & MILWAUKEE: only jaws with the  marking are compatible.

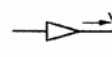

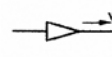

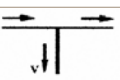

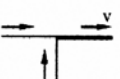
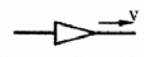
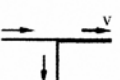

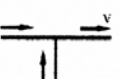
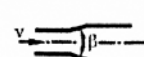
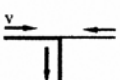
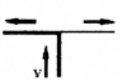

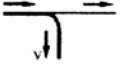

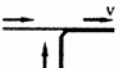
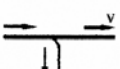
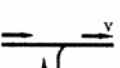
6.5.1 Use of Tools

If other machines and press jaws are used, their suitability for a permanent tight connection must be demonstrated by an accredited test. A constant thrust of at least 32 KN and max. 36 KN.

KN is a prerequisite to ensure that sufficient power reserves for the dimension of 54 mm are available and that high shear forces cannot reduce the lifetime of the pressing jaws or destroy them.

7. Loss Coefficients

Symbol	Designation	ζ	Application		Symbol	Designation	ζ	Application	
			DW	H				DW	H
	Angle or elbow reference value in accordance with DIN 1988 T3	0,70	X	X		Distributor outlet	0,5	X	X
	Angle 90° r/d = 0,5 (r/d = 1,2 = 1,0 with fittings = 2,0 complying with DIN EN 1254) = 3,0	1,0 0,35 0,20 0,15	X X X X	X X X X		Collective inlet	1,0	X	X
	Angle $\beta = 90^\circ$ = 60° = 45°	1,3 0,8 0,4	X X X	X X X		Reservoir outlet	0,5	X	
						Inlet	1,0	X	X
	Crossover	0,5	X	X		Reducer	0,4	X	X
						Constriction β - constant = 30° 45° 60°	0,02 0,04 0,07	X X X	X X X
	Branch, square flow separation	1,3	X	X		Expansion β - constant = 10° 20° 30° 40°	0,10 0,15 0,20 0,20	X X X X	X X X X
	Flow merging	0,9	X	X		Expansion bends	1,0	X	X
	Clearance at flow merging	0,3	X	X		Compensator	2,0	X	X
	Clearance at flow merging	0,6	X	X		Compensator	2,0	X	X
	Counter-flow at flow merging	3,0	X	X					
	Counter-flow at flow separation	1,5	X	X					

Symbol	Designation	ζ	Application		Symbol	Designation	ζ	Application		
			DW	H				DW	H	
	Branch, curved flow separation	0,9	X	X		Shut-off valve	10,0 8,5 7,0 6,0 5,0	X X X X X	X X X X X	
	Flow merging	0,4	X	X		Straight seat valve				
	Clearance at flow separation	0,3	X	X		DN15				
	Clearance at flow merging	0,2	X	X		DN20				
	Angle valves	7,0 4,0 2,0 3,5 4,0	X X X X X	X X X X X		Return flow inhibitor	7,7 4,3 3,8 2,5	X X X X	X X X X	
	DN 10									DN 15 to DN 20
	DN 15									DN 25 to DN 40
	DN 20									DN 50
	to DN 50									DN 65 to DN 100
DN 65 to DN 100										
	Diaphragm valves	10,0 8,5 7,0 6,0 5,0	X X X X X	X X X X X		Control valve with return flow inhibitor	6,0 5,0	X X	X X	
	DN 15									DN 20
	DN 20									DN 25 to DN 50
	DN 25									DN 40 to DN 100
	to DN 32									
DN 40 to DN 100										
	Shutter valves	1,0 0,5 0,3	X X X	X X X		Valve tapping sleeve	5,0	X		
	Piston valves									DN 10 to DN 15
	Ball valves									DN 20 to DN 25
	DN 10 to DN 15									DN 32 to DN 150
DN 20 to DN 25										
DN 32 to DN 150										
	Radiator valves	4,0		X		Boiler	2,5		X	
	Control valve	2,0		X						
	Pressure regulator fully open	30,0		X		Heating radiator	2,5		X	
						Panel radiator	3,0		X	

8. Installation Requirements

8.1 Installation Dimensions

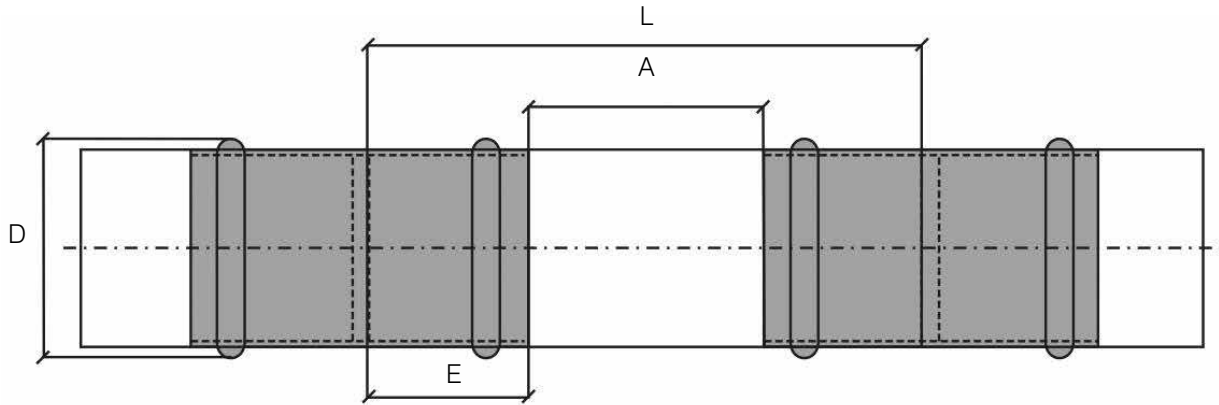

Size	Nominal External Ø Pipe	Nominal External-Ø Bead	Minimum Distance	Minimum Pipe Length	Insertion Depth
	mm	D - mm	A - mm	L - mm	E - mm
15	15	23	10	54	22
22	22	31.5	20	66	23
28	28	37.0	20	68	24
35	35	44.2	25	79	28
42	42	54.4	30	102	36
54	54	65.4	35	116	41

When using the Conex Bänninger >B< Press tool, a minimum distance from the centre of the press bead to the adjacent component (e.g. walls or ceilings) of 45 mm is required.

8.2 Tube Dimensions

Dimensions of light gauge Stainless steel tubes – EN 10312 Series 1 and 2.

Specified Outside Diameter D	Outside Diameter		Specified Wall Thickness T
	Maximum	Minimum	
Size mm	mm	mm	mm
15	15.04	14.94	0,6
22	22.05	21.95	0,7
28	28.05	27.95	0,8
35	38.07	34.97	1,0
42	42.07	41.97	1,1
54	54.07	53.84	1,2

Series 1 Stainless steel tubes dimensions

Specified Outside Diameter D	Specified Wall Thickness T	Tolerance on T
Size mm	mm	mm
15	1,0	± 0,10
22	1,2	± 0,10
28	1,2	± 0,10
35	1,5	± 0,10
42	1,5	± 0,10
54	1,5	± 0,10

Series 2 Stainless steel tubes dimensions

8.3 Minimum Tool Access

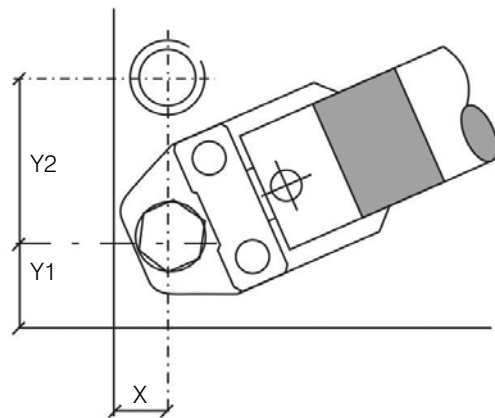
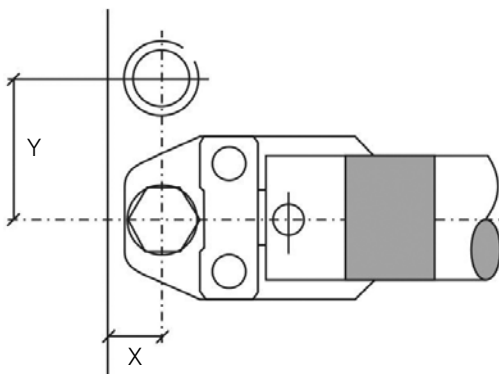

10

Space required for the pressing process between pipes		
External pipe	X	Y
Size mm	mm	mm
15	26	53
22	26	56
28	33	69
35	33	73
42	75	115
54	85	120

Space required for the pressing process between tubes			
External pipe	X	Y1	Y2
Size mm	mm	mm	mm
15	31	45	73
22	31	45	76
28	38	55	80
35	38	55	85
42	75	75	115
54	85	85	140

9. Tube Preparation

Correct tube preparation is essential for problem free installation, just follow these simple guidelines. Incorrect tube preparation can damage the O-ring and cause the fittings to leak.

Note: Grinding wheels and hacksaws are not suitable for cutting the tube. If the tube ends become distorted, remove the damaged section using the appropriate cutting method.

When preparing tube ensure that the tube is correctly supported and eye protection is worn. If using power tools, great care must be taken. Refer to the manufacturers instructions before use.

Sizes 15 mm - 54 mm

9.1 Tube Cutting



1. Cut tube ends should be clean and free from scratches with no sharp edges.

Wipe clean the tube of swarf and debris to avoid damage to the O-ring on tube insertion.



Domed



Sharp edge

9.2 Tube Deburring



2. Make sure that the internal and external tube ends are free from burrs or sharp edges.

If a deburrer is not available then a fine file can be used to remove the sharp edges.



Chamfer



Burrs

10. Fitting Installation Instructions

It is advisable to leave the fittings in the packaging prior to final installation to protect them from contamination and to conserve the lubrication of the O-rings. Please note the space required for pressing tools (see section 8).

10.1 Cutting to length



To cut the tube use a tube cutter, fine-tooth saw or a special electrical tube saw. It is important to ensure that the tube is cut completely square. Tube ends should be clean and free from scratches not less than the socket length.

10.2 Deburring and calibrating



Make sure that the internal and external tube end is free from burrs or sharp edges by using a deburring tool to prevent damage to the O-ring. Then wipe the tube end clean to avoid damaging the O-ring on tube insertion.

10.3 Checking the fittings



Inspect the fitting, checking the O-ring(s) are present and correctly seated and that the fitting is the correct size for the tube.

10.4 Marking the insertion depth



The tube must be fully inserted into the fitting until it reaches the tube stop in order to make a perfect joint. Marking insertion depth will ensure that any tube movement is detected, which is especially important if the joints are to be pressed at a later time.

Caution: Do not measure the socket depth by pushing the tube into the fitting then marking the tube.

10.5 Assembling the tube and fitting



To assemble the joint, the tube must be inserted into the fitting up to the tube stop. (Use the mark on the tube which was made earlier as reference). The pressing operation should only be undertaken when the tube reaches the tube stop (see section 8).

10.6 Complete the joint with the press tool



Ensure that the correct size jaw for the fitting is inserted into the tool. The jaws must be placed square on the fitting. Depress the trigger/button to begin the compression cycle of the tool. This is complete when the mouth of the fitting is fully enclosed by the jaws. Now release the jaws from around the fitting. (For further information refer to tooling instructions).

Caution: The >B< Press Inox joint is complete after one full cycle of the tool. Do not crimp any >B< Press Inox fitting more than once.

11. The Range

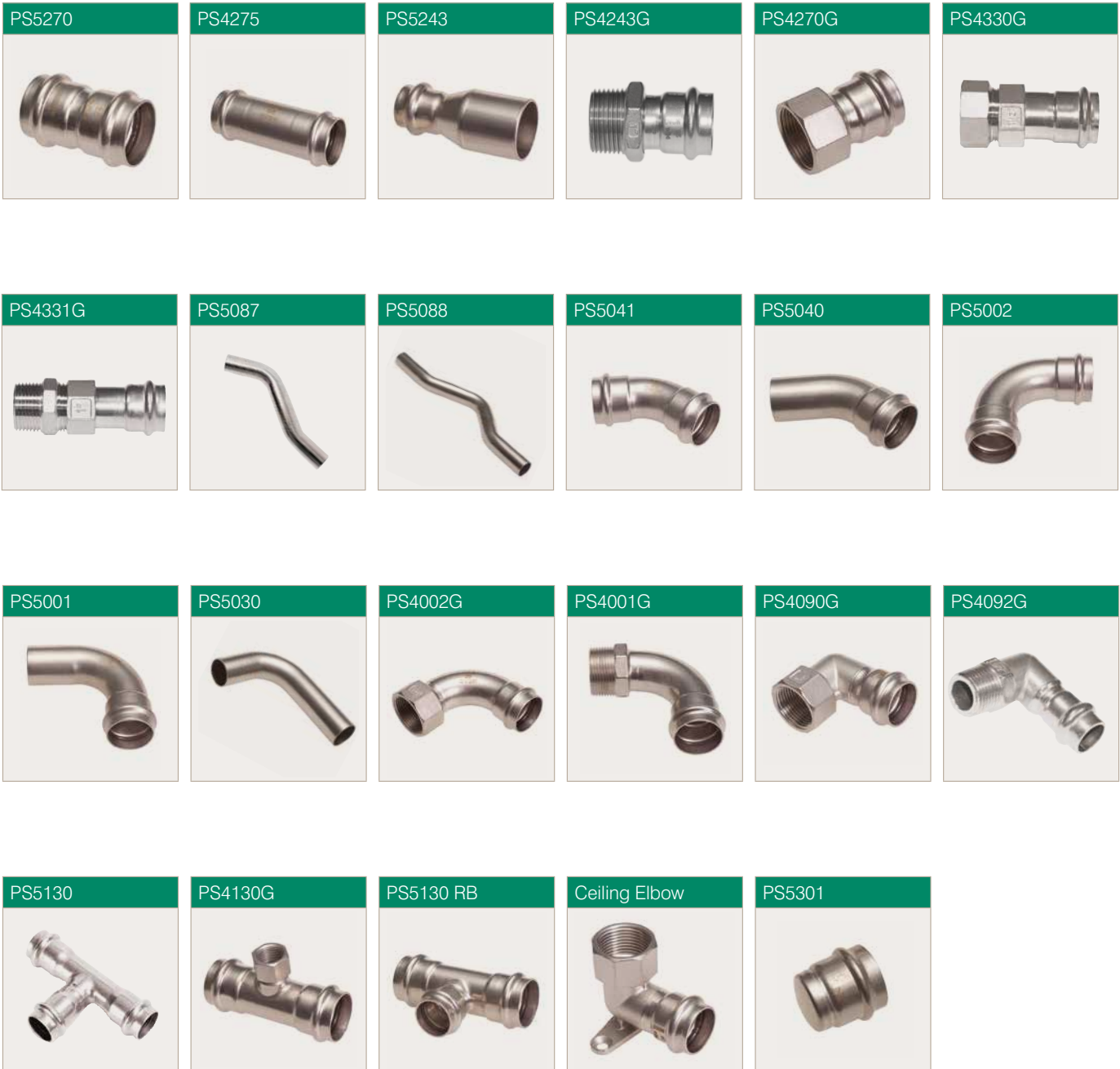

PS5270

Straight Coupler

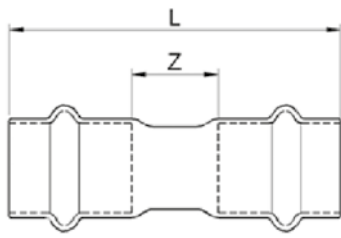

Dimension	L	Z					Product code
15	54	10					PS 5270 0150000
18	54	10					PS 5270 0180000
22	56	10					PS 5270 0220000
28	58	10					PS 5270 0280000
35	66	10					PS 5270 0350000
42	87	15					PS 5270 0420000
54	98	16					PS 5270 0540000

PS4275

Slip Coupler

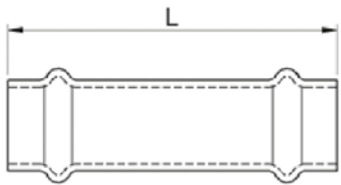

Dimension	L						Product code
15	80						PS 4275 0150000
18	80						PS 4275 0180000
22	85						PS 4275 0220000
28	95						PS 4275 0280000
35	105						PS 4275 0350000
42	120						PS 4275 0420000
54	135						PS 4275 0540000

PS5243

Fitting Reducer

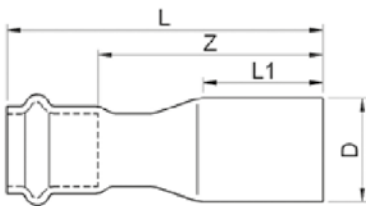

Dimension	L	L1	Z	D			Product code
18 x 15	63	29	41	18			PS 5243 0181500
22 x 15	70	30	48	22			PS 5243 0221500
22 x 18	62	30	40	22			PS 5243 0221800
28 x 15	77	31	55	28			PS 5243 0281500
28 x 18	72	31	50	28			PS 5243 0281800
28 x 22	90	34	67	28			PS 5243 0282200
35 x 18	81	34	59	35			PS 5243 0351800
35 x 22	76	34	53	35			PS 5243 0352200
35 x 28	72	34	48	35			PS 5243 0352800
42 x 28	92	44	68	42			PS 5243 0422800
42 x 35	85	44	58	42			PS 5243 0423500
54 x 28	112	48	89	54			PS 5243 0542800
54 x 35	106	48	79	54			PS 5243 0543500
54 x 42	108	48	70	54			PS 5243 0544200

PS4243G

Male Straight Coupler

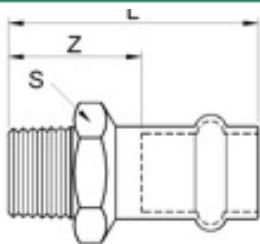

Dimension	L	Z	S				Product code
15 x 1/2"	54	32	22				PS 4243G 0150400
18 x 1/2"	55	32	22				PS 4243G 0180400
18 x 3/4"	56	34	28				PS 4243G 0180600
22 x 1/2"	56	32	22				PS 4243G 0220400
22 x 3/4"	57	34	28				PS 4243G 0220600
22 x 1"	60	37	36				PS 4243G 0220800
28 x 3/4"	58	34	28				PS 4243G 0280600
28 x 1"	61	37	36				PS 4243G 0280800
35 x 1 1/4"	71	41	43				PS 4243G 0351000
42 x 1 1/2"	79	44	50				PS 4243G 0421200
54 x 2"	92	51	62				PS 4243G 0541600

PS4270G

Female Straight Coupler

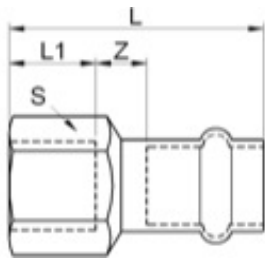

Dimension	L	L1	Z	S	Product code
15 x 1/2"	50	15	13	26	PS 4270G 0150400
18 x 1/2"	50	15	13	26	PS 4270G 0180400
18 x 3/4"	52	16	14	31	PS 4270G 0180600
22 x 1/2"	51	15	13	26	PS 4270G 0220400
22 x 3/4"	53	16	14	31	PS 4270G 0220600
22 x 1"	57	19	15	39	PS 4270G 0220800
28 x 3/4"	53	16	13	31	PS 4270G 0280600
28 x 1"	58	19	15	39	PS 4270G 0280800
35 x 1 1/4"	67	21	17	48	PS 4270G 0351000
42 x 1 1/2"	77	21	20	55	PS 4270G 0421200
54 x 2"	88	26	20	67	PS 4270G 0541600

PS4330G

Female Straight Union Connector

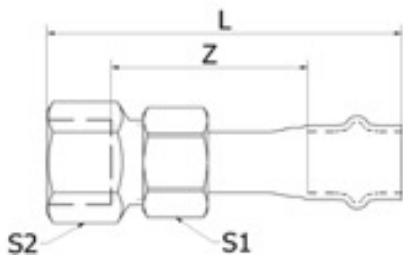



Dimension	L	Z	S1	S2	Product code
15 x 1/2"	79	46	26	26	PS 4330G 0150400
15 x 3/4"	87	45	31	31	PS 4330G 0150600
18 x 1/2"	80	46	26	26	PS 4330G 0180400
18 x 3/4"	82	44	31	31	PS 4330G 0180600
22 x 3/4"	84	50	31	31	PS 4330G 0220600
22 x 1"	91	48	39	39	PS 4330G 0220800
28 x 1"	92	49	39	39	PS 4330G 0280800
35 x 1 1/4"	103	47	48	48	PS 4330G 0351000
42 x 1 1/2"	117	63	55	55	PS 4330G 0421200
54 x 2"	131	63	67	67	PS 4330G 0541600

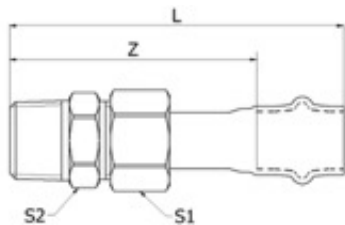

PS4331G

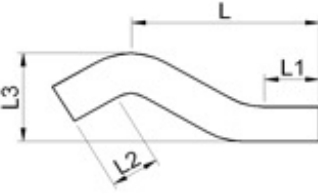

Male Straight Union Connector



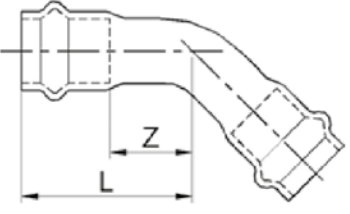

Dimension	L	Z	S1	S2	Product code
15 x 1/2"	85	63	26	22	PS 4331G 0150400
18 x 1/2"	82	63	26	22	PS 4331G 0180400
22 x 3/4"	88	65	31	28	PS 4331G 0220600
28 x 1"	98	75	39	36	PS 4331G 0280800
35 x 1 1/4"	114	85	48	43	PS 4331G 0351000
42 x 1 1/2"	123	87	55	50	PS 4331G 0421200
54 x 2"	139	93	67	62	PS 4331G 0541600

PS5087		Short Crossover					
		Dimension	L	L1	L2	L3	Product code
		15	97	40	40	42	PS 5087 0150000
		18	121	50	50	52	PS 5087 0180000
		22	133	55	55	58	PS 5087 0220000
		28	155	60	60	71	PS 5087 0280000

PS5088		Long Crossover					
		Dimension	L	L1	L2	H	Product code
		15	215	50	50	47	PS 5088 0150000
		18	252	55	55	58	PS 5088 0180000
		22	283	65	65	64	PS 5088 0220000
		28	318	65	65	78	PS 5088 0280000

PS5041		45° Obtuse Elbow				
		Dimension	L	Z		Product code
		15	35	13		PS 5041 0150400
		18	37	15		PS 5041 0180400
		22	40	17		PS 5041 0220600
		28	45	21		PS 5041 0280800
		35	52	25		PS 5041 0351000
		42	70	34		PS 5041 0421200
		54	80	39		PS 5041 0541600

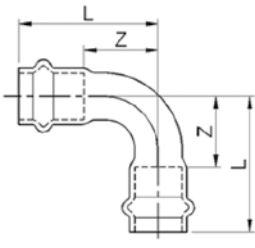
PS5040		45° Obtuse Street Elbow				
		Dimension	L	L1	Z	Product code
		15	35	42	13	PS 5040 0150000
		18	37	44	15	PS 5040 0180000
		22	40	47	17	PS 5040 0220000
		28	45	53	21	PS 5040 0280000
		35	52	59	25	PS 5040 0350000
		42	70	74	34	PS 5040 0420000
		54	80	86	39	PS 5040 0540000

PS5002		90° Elbow				
		Dimension	L	Z		Product code
		15	46	24		PS 5002 0150000
		18	50	28		PS 5002 0180000
		22	55	32		PS 5002 0220000
		28	66	42		PS 5002 0280000
		35	78	51		PS 5002 0350000
		42	100	64		PS 5002 0420000
		54	120	79		PS 5002 0540000

PS5001		90° Street Elbow					
	Dimension	L	L1	Z			Product code
	15	46	53	24			PS 5001 0150000
	18	50	57	28			PS 5001 0180000
	22	55	63	32			PS 5001 0220000
	28	66	74	42			PS 5001 0280000
	35	78	85	51			PS 5001 0350000
	42	100	108	64			PS 5001 0420000
	54	120	125	79			PS 5001 0540000

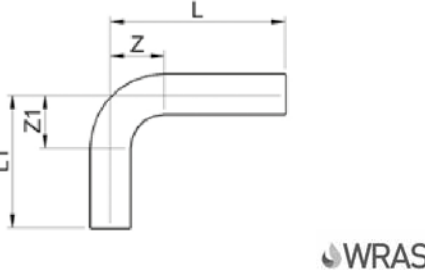
PS5030		Male Street Bend					
	Dimension	L	L1	Z	Z1		Product code
	15	120	70	19	19		PS 5030 0150000
	18	120	70	22	22		PS 5030 0180000
	22	120	70	27	27		PS 5030 0220000
	28	140	90	36	36		PS 5030 0280000
	35	140	90	45	45		PS 5030 0350000
	42	160	110	53	53		PS 5030 0420000
	54	160	110	67	67		PS 5030 0540000

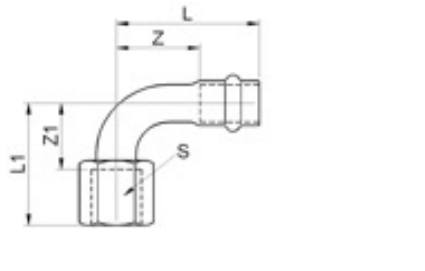
PS4002G		90° Bend with Female Thread					
	Dimension	L	L1	Z	Z1	S	Product code
	15 x 1/2"	46	43	24	28	26	PS 4002G 0150400
	18 x 1/2"	50	46	28	31	26	PS 4002G 0180400
	18 x 3/4"	50	48	28	32	31	PS 4002G 0180600
	22 x 3/4"	55	53	32	36	31	PS 4002G 0220600
	28 x 1"	66	66	42	47	39	PS 4002G 0280800
	35 x 1 1/4"	78	79	51	57	48	PS 4002G 0351000
	42 x 1 1/4"	100	88	64	67	55	PS 4002G 0421200
54 x 2"	120	107	79	81	67	PS 4002G 0541600	

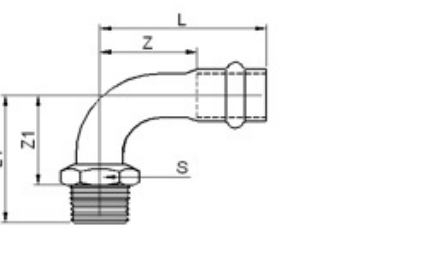
PS4001G		90° Bend with Male Thread					
	Dimension	L	L1	Z	Z1	S	Product code
	15 x 1/2"	46	47	24	34	22	PS 4001G 0150400
	18 x 1/2"	50	52	28	39	22	PS 4001G 0180400
	18 x 3/4"	50	54	28	39	28	PS 4001G 0180600
	22 x 3/4"	55	56	32	41	28	PS 4001G 0220600
	28 x 1"	66	66	42	49	36	PS 4001G 0280800
	35 x 1 1/4"	78	78	51	59	43	PS 4001G 0351000
	42 x 1 1/2"	100	86	64	67	50	PS 4001G 0421200
54 x 2"	120	107	79	83	62	PS 4001G 0541600	

PS4090G

90° Elbow with Female Thread

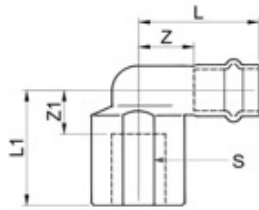

Dimension	L	L1	Z	Z1	S	Product code
15 x 1/2"	46	30	24	15	26	PS 4090G 0150400
18 x 1/2"	46	30	24	15	26	PS 4090G 0180400
22 x 1/2"	47	30	24	15	26	PS 4090G 0220400
22 x 3/4"	56	36	33	20	31	PS 4090G 0220600
28 x 1"	56	43	32	23	39	PS 4090G 0280800
35 x 1 1/4"	66	49	39	28	48	PS 4090G 0351000

PS4092G

90° Elbow with Male Thread

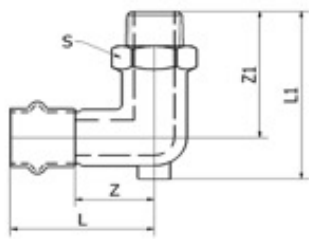

Dimension	L	L1	Z	Z1	S	Product code
15 x 1/2"	50	34	20	45	22	PS 4092G 0150400
18 x 1/2"	50	34	20	45	22	PS 4092G 0180400

PS5130

Equal Tee

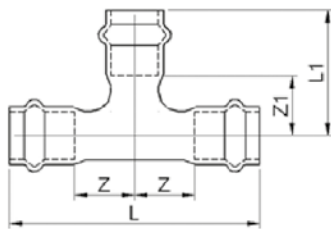

Dimension	L	Z	L1	Z1	Product code
15	82	22	39	14	PS 5130 0151515
18	82	22	42	17	PS 5130 0181818
22	88	24	45	19	PS 5130 0222222
28	96	28	50	22	PS 5130 0282828
35	111	31	56	25	PS 5130 0353535
42	134	36	71	30	PS 5130 0424242
54	159	41	82	36	PS 5130 0545454

PS4130G

Tee with Female Branch

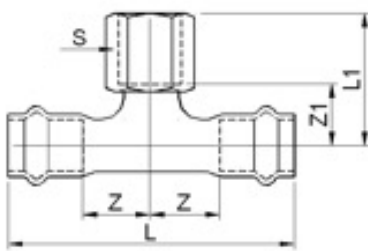

Dimension	L	L1	Z	Z1	S	Product code
15 x 1/2"	82	34	19	19	26	PS 4130G 0150415
18 x 1/2"	82	37	19	22	26	PS 4130G 0180418
18 x 3/4"	82	39	19	23	31	PS 4130G 0180618
22 x 1/2"	88	39	21	24	26	PS 4130G 0220422
22 x 3/4"	88	40	21	24	31	PS 4130G 0220622
28 x 1/2"	96	41	24	26	26	PS 4130G 0280428
28 x 3/4"	96	43	24	27	31	PS 4130G 0280628
28 x 1" x 28	97	47	24	28	39	PS 4130G 0280828
35 x 1/2"	108	44	27	29	26	PS 4130G 0350435
35 x 3/4"	108	46	27	28	31	PS 4130G 0350635
35 x 1 1/4"	108	54	27	33	48	PS 4130G 0351035
42 x 1/2"	134	48	31	33	26	PS 4130G 0420442
42 x 3/4"	134	50	31	34	31	PS 4130G 0420642
42 x 1 1/2"	134	59	31	38	55	PS 4130G 0421242
54 x 1/2"	159	54	36	39	26	PS 4130G 0540454
54 x 3/4"	159	56	36	40	31	PS 4130G 0540654
54 x 2" x 54"	159	70	36	44	67	PS 4130G 0541654

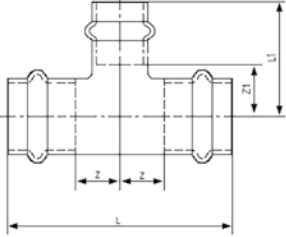
PS5130		Reduced Branch Tee					
	Dimension	L	Z	L1	Z1		Product code
	18 x 15 x 18	82	19	39	17		PS 5130 0181518
	22 x 15 x 22	88	21	41	19		PS 5130 0221522
	22 x 18 x 22	88	21	41	19		PS 5130 0221822
	28 x 15 x 28	96	24	54	32		PS 5130 0281528
	28 x 18 x 28	96	24	54	32		PS 5130 0281828
	28 x 22 x 28	96	24	44	21		PS 5130 0282228
	35 x 15 x 35	111	27	57	35		PS 5130 0351535
	35 x 18 x 35	111	27	64	35		PS 5130 0351835
	35 x 22 x 35	111	27	48	25		PS 5130 0352235
	35 x 28 x 35	111	27	49	25		PS 5130 0352835
	42 x 22 x 42	134	30	51	28		PS 5130 0422242
	42 x 28 x 42	134	30	52	28		PS 5130 0422842
	42 x 35 x 42	134	30	55	28		PS 5130 0423542
	54 x 22 x 54	159	36	57	34		PS 5130 0542254
	54 x 28 x 54	159	36	58	34		PS 5130 0542854
	54 x 35 x 54	159	36	64	34		PS 5130 0543554
54 x 42 x 54	159	36	77	36		PS 5130 0544254	

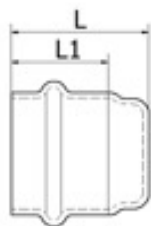

PS5301		Stop End					
	Dimension	L	L1				Product code
	15	34	22				PS 5301 0150000
	18	34	22				PS 5301 0180000
	22	37	23				PS 5301 0220000
	28	38	24				PS 5301 0280000
	35	43	27				PS 5301 0350000
	42	55	36				PS 5301 0420000
	54	59	41				PS 5301 0540000



Notes



Conex | Bänninger

Conex | Bänninger
>B< Press

Conex | Bänninger
>B< Press Gas

Conex | Bänninger
>B< Press Solar

Conex | Bänninger
>B< Press XL

Conex | Bänninger
>B< Press Carbon

Conex | Bänninger
>B< Press Inox

Conex | Bänninger
>B< MaxiPro

Conex | Bänninger
>B< ACR

K65®

Conex | Bänninger
>B< Push

Conex | Bänninger
>B< Flex

Conex | Bänninger
>B< Oyster

Conex | Bänninger
Cuprofit

Conex | Bänninger
Triflow Solder Ring

Conex | Bänninger
Delcop End Feed

Conex | Bänninger
Delbraze

Conex | Bänninger
Medical Gas

Conex | Bänninger
Valves

Conex | Bänninger
Conex Compression

Conex | Bänninger
Series 3000

Conex | Bänninger
Series 4000

Conex | Bänninger
Series 5000

Conex | Bänninger
Series 8000

Conex | Bänninger
OEM



United Kingdom
Conex Universal Limited

Germany
IBP GmbH

Spain/France
IBP Atcosa SL

Italy
IBP Banninger Italia srl

Poland Sales, Marketing and logistics
IBP Instalittings Sp z.o.o.

China
IBP China

Tel: +44 (0)121 557 2831 | Fax: +44 (0)121 557 0185 | Email: salesuk@ibpgroup.com | Website: www.conexbanninger.com

The content of this publication is for general information only. It is the user's responsibility to determine suitability of any product for the purpose intended and reference should be made to our Technical Department if clarification is required. In the interests of technical development we reserve the right to change specification, design and materials without notice.

Conex Bänninger products are approved by numerous Standards Authorities and Certification Bodies. For more details on this product range, please email our technical team: technical@ibpgroup.com This is a representation of the full range from Conex Universal Ltd. IBP trademarks are registered in numerous countries.