

MULTILAYER PIPES



Technical data sheet for multilayer pipes for sanitary, heating and cooling installations

Contents

DESCRIPTION	3
ADVANTAGES	4
FIELDS OF APPLICATION	5
COMPOSTION OF BARE PIPE	6
COMPOSITION OF COATED PIPE	7
CROSS-LINKED POLYETHYLENE (PEX)	9
PERMEABILITY TO OXYGEN	9
ADHESIVE PRIMER	10
COVERING (in case of coated pipe)	10
APPLICATION CLASSES	11
TECHNICAL DATA	12
DIMENSIONS	12
VOLUME AND WEIGHT	12
CONDUCTIVITY AND EXPANSION	13
TEMPERATURE AND PRESSURE	13
BENDING RADIUS	13
SHEATH TECHNICAL CHARACTERISTICS	14
REGULATIONS	14
CERTIFICATIONS	14
MARKINGS	15
PRESSURE DROPS	15
FITTINGS	15
THERMAL EXPANSION	16
THERMAL AND ACOUSTIC INSULATION	17
FLUIDS AND REAGENTS	18
PIPES INSTALLATION	24
CAUTIONS	26

Technical data sheet of multilayer pipes for water instalaltions

Multilayer pipes for sanitary,
heating, cooling and
compressed air systems



DESCRIPTION

The multilayer pipe of the TB200.20 series is characterized by a 5-layer structure in which a butt-welded aluminum layer is enclosed between two layers of cross-linked polyethylene (PEX) and fixed to the latter by two layers of adhesive.

Thanks to this feature, TB00.20 pipe represents a perfect combination of the properties of plastic (cross-linked polyethylene with high mechanical resistance) and ductile metal (highly flexible aluminum), in which the qualities of PEX are added to those of aluminum, giving life to a product with extraordinary and multiple qualities.







PEX confers chemical resistance, corrosion resistance, lightness, hygiene and guarantees a very smooth and polished surface in contact with the transported fluid such as to reduce pressure drops and avoid encrustations.

The presence of aluminum allows the pipe to be modeled very easily in order to significantly speed up installation and prevent the passage of oxygen inside the pipeline. The pipe is suitable for sanitary, heating, cooling and compressed air systems.

ADVANTAGES

- Excellent sound insulation: the elasticity of the cross-linked polyethylene allows for excellent absorption of vibrations
- Corrosion resistance
- Lightness: pipes are much lighter than metal pipes
- Hygiene: the materials used are non-toxic and certified for the transport of drinking water
- Hygiene, absence of encrustations and fungi (the extreme smoothness of the internal surface reduces the possibility of obstructions caused by the growth of encrustations and fungi)
- Reduced pressure drops: the smooth and polished internal surface reduces pressure drops and avoids the formation of encrustations
- Flessibilità: la presenza dell'alluminio ad alto grado di snervamento consente di modellare il tubo con estrema facilità
- Reduced thermal expansion: thermal expansion is limited to $0.026\text{mm} / \text{m} \text{ } ^\circ \text{C}$
- Chemical and electrochemical resistance (PEX being a bad electrical conductor it is not subject to destructive phenomena of stray currents)
- Barrier to light and oxygen: the butt-welded aluminum layer forms an oxygen barrier that promotes the formation of algae, fungi and corrosion
- Ideal for seismic areas thanks to its flexibility and ability to attenuate vibrations

FIELDS OF APPLICATION

APPLICATIONS		T. of the system
	drinking water	-20°C/+95°C
	hot sanitary water	-20°C/+95°C
	cooling	-20°C/+95°C
	conditioning	-20°C/+95°C
	radiators	-20°C/+95°C
	floor heating (low temperature)	-20°C/+95°C
	irrigation	-20°C/+95°C

COMPOSITION OF BARE PIPE

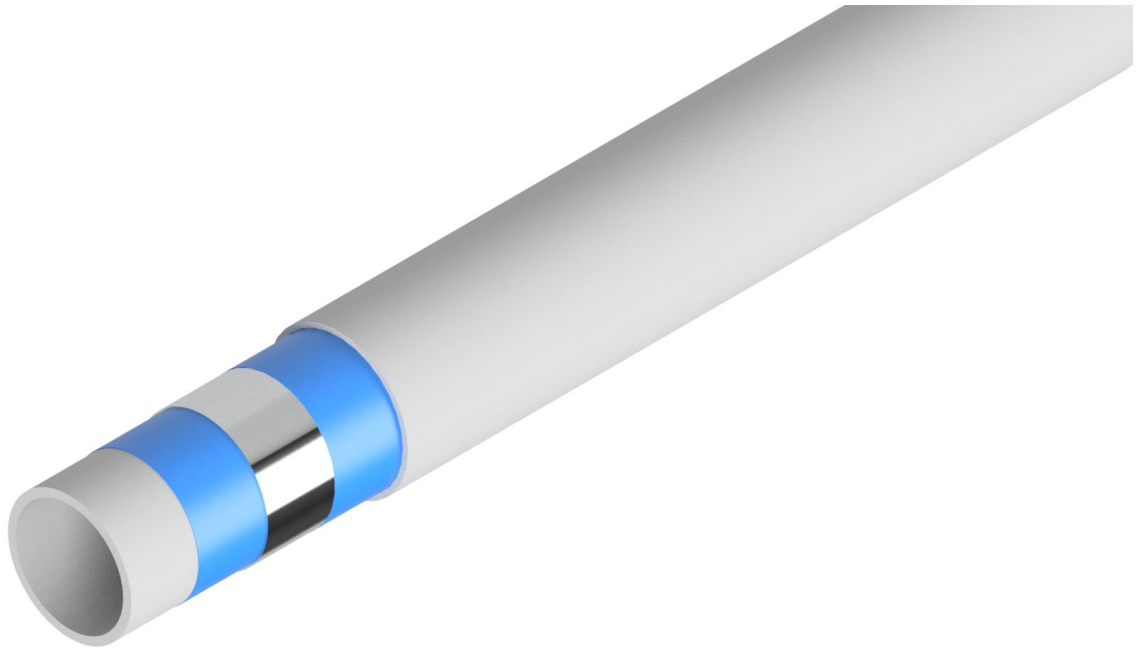

LAYER COMPOSITION

An inner pipe in catalyst cross-linked polyethylene (PEX-b), extruded with cross-linkable high-density polyethylene

A layer of high quality glue to ensure a homogeneous connection between the aluminum pipe and the inner pipe in PEX-b

An aluminum tube, longitudinally welded and electronically controlled

A layer of high quality glue to ensure a homogeneous connection between the aluminum pipe and the external PEX-b pipe

An outer pipe in catalyst cross-linked polyethylene (PEX-b), extruded with cross-linkable high-density polyethylene

COMPOSITION OF COATED PIPE

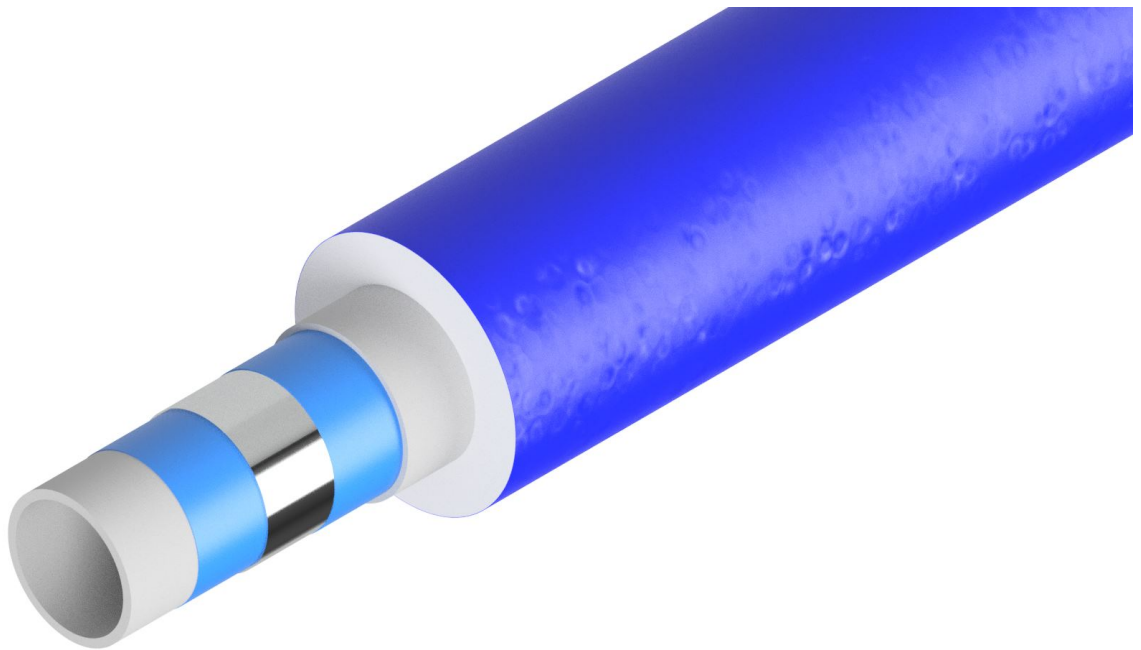

LAYER COMPOSITION

An inner pipe in catalyst cross-linked polyethylene (PEX-b), extruded with cross-linkable high-density polyethylene

A layer of high quality glue to ensure a homogeneous connection between the aluminum pipe and the inner pipe in PEX-b

An aluminum tube, longitudinally welded and electronically controlled

A layer of high quality glue to ensure a homogeneous connection between the aluminum pipe and the external PEX-b pipe

An outer pipe in catalyst cross-linked polyethylene (PEX-b), extruded with cross-linkable high-density polyethylene

Coating: layer of insulating material, made of closed cell expanded polyethylene, which increases the energy efficiency of the installation, and further improves the already reduced noise level.

BLUE COATED PIPE

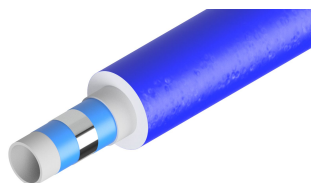

RED COATED PIPE

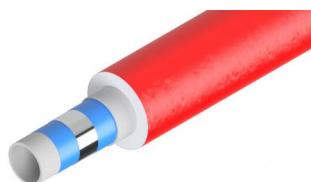

GREY COATED PIPE

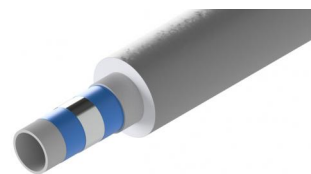

WHITE COATED PIPE - WHITE FRIO

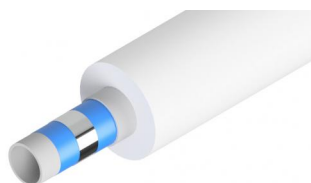

CROSS-LINKED POLYETHYLENE (PEX)

Polyethylene is a thermoplastic polymeric material composed of numerous long molecules which, even at moderately high temperatures (still below the melting point), begin to have a significant degree of fluidity.

With the crosslinking process, the polyethylene molecules bind together to form a more complex three-dimensional structure: the chemical crosslinking reaction transforms the product from thermoplastic to thermosetting.

The material undergoes a structural modification that improves its characteristics such as abrasion, chemical resistance, mechanical resistance over time, resistance to aging and high temperatures. The mechanical performance of the material is significantly increased.

Cross-linked polyethylene can be produced using different technologies recognized by international standards and identified with methods A (peroxides), B (silanes), C (radiation). The method used is indicated after the material code, obtaining respectively PE-Xa, PE-Xb, PE-Xc.

All the above methods are valid: it is not the crosslinking process that defines the goodness of the product, but its ability to pass the physical and mechanical tests defined by the standards.

In the case of PE-Xb, the internal and external layers of the pipe are cross-linked with the silane method: cross-linking takes place with the creation of chemical bonds due to the presence of silanes. This process takes place partly during the extrusion phase but mainly in a second stage which consists in placing the bars or coils of tube in a tub of water at temperatures between 70 ° C and 95 ° C.

The crosslinking process, which reaches a minimum percentage of 65%, is activated by humidity and temperature. The crosslinking process never reaches 100% as the polyethylene would become very brittle and subject to mechanical breakage.

In general, the crosslinking varies from 65% to 89% and depends on the crosslinking method used: a crosslinking of less than 65% does not guarantee sufficient performance in terms of chemical and mechanical resistance.

The butt-welded aluminum sheet with laser technology is the heart of General Fittings' multilayer pipe. The aluminum sheet, with variable thickness for each diameter produced, is previously cylindrically shaped on the inner layer of PEX before welding. The aluminum tape must meet high quality standards.

The alloy used has excellent mechanical characteristics (high yield point) and excellent weldability.

PERMEABILITY TO OXYGEN

General Fittings pipe is impermeable to any diffusion phenomenon, as the intermediate aluminum structure guarantees a zero passage of gases inside the tube itself.

This feature makes it the perfect solution in any heating system that includes aluminum exchangers or metal tube bundles sensitive to oxygen diffusion.

General Fittings multilayer pipes can also be used in underfloor heating systems in compliance with the provisions of the UNI EN1264 standard which prescribes an oxygen diffusion barrier on the pipes for radiant floor heat systems, limiting it to 0.32 mg / m² per day in order to avoid the reduction of the useful life of the pipe itself.

ADHESIVE PRIMER

The aluminum tape is attached to the inner and outer PEX layers by two layers of glue. The latter was specifically developed to maximize the adhesion between PEX and aluminum and to ensure that the bond strength does not decline with time and with high temperatures. Thanks to the adhesive, the two layers of PEX and the aluminum layer form a whole with superior properties compared to the single component.

COVERING (in case of coated pipe)

The layer of insulating material, made of closed cell polyethylene foam, in addition to increasing the energy efficiency of the installation, further improves the already reduced noise level of systems made of synthetic materials.

La sezione isolante è costituita da uno strato di polietilene espanso a cellule chiuse (privo di CFC) protetto da una caratteristica pellicola di rivestimento esterna di colore rosso, blu e grigio (per impianti di riscaldamento) e di colore bianco (per impianti di condizionamento / acqua refrigerata).

APPLICATION CLASSES

Class	Design Temperature	TIME _b at TD	T max	Time at T max	T mal	Time at T mal	Typical Field of application
1a	60	49	80	1	95	100	Hot water supply (60 °C)
2a	70	49	80	1	95	100	Hot water supply (70 °C)
4b	20 plus cumulative	2.5	70	2.5	100		Underfloor heating and low temperatures radiators
4b	40 plus cumulative	20	70	2.5	100		Underfloor heating and low temperatures radiators
4b	60	25	70	2.5	100		Underfloor heating and low temperatures radiators
5b	20 plus cumulative	14	90	1	100		High temperatures radiators
5b	60 plus cumulative	25	90	1	100		High temperatures radiators
5b	80	10	90	1	100		High temperatures radiators

TECHNICAL DATA

TECHNICAL DATA	
Type of material	PEX-b/Al/PEX-b
Application class (EN ISO 21003)	CL 2-5 10bar
T. Min	-20 °C (with the use of glycol in a maximum percentage of 35%)
Maximum operating temperature (EN ISO 21003-1)	90 °C
Peak temperature (EN ISO 21003-1)	95 °C
Maximum working pressure (EN ISO 21003-1)	10 bar
Thermal expansion coefficient	0,026 mm/m K
Thermal conductivity	0,42÷0,52 W/m K
Inner pipe surface roughness	0,007 mm
Permeability to oxygen	0 mg/l
Resistance to water vapor diffusion	$\mu > 5000$
BEHAVIOR IN FIRE	
bare pipe (EN 13501-1): C-s2, d0	C-s2,d0
insulation (EN 13501-1 LNE P126686)	CL-s1,d0

DIMENSIONS

NOMINAL DIAMETER OF THE PIPE	16x2.0	20x2.0	26x3.0	32x3.0
TYPE OF PLASTIC MATERIAL (5 layers)	PE-Xb /Al/PE-Xb			
EXTERNAL DIAMETER mm	16	20	26	32
INTERNAL DIAMETER mm	12	16	20	26
THICKNESS mm	2		3	

VOLUME AND WEIGHT

NOMINAL DIAMETER OF THE PIPE	16x2.0	20x2.0	26x3.0	32x3.0
VOLUME CONTENT OF WATER l / m	0.113	0.201	0.314	0.535

CONDUCTIVITY AND EXPANSION

NOMINAL DIAMETER OF THE PIPE	16x2.0	20x2.0	26x3.0	32x3.0
COEFFICIENT OF THERMAL CONDUCTION w / mk	0.4			
COEFFICIENT OF LINEAR THERMAL EXPANSION mm / m · k	0.026			
INNER PIPE SURFACE ROUGHNESS mm	0.007			

TEMPERATURE AND PRESSURE

NOMINAL DIAMETER OF THE PIPE	16x2.0	20x2.0	26x3.0	32x3.0
MAXIMUM OPERATING TEMPERATURE ° C	90			
MINIMUM OPERATING TEMPERATURE ° C	-20			
PEAK TEMPERATURE (malfunction) ° C	95			
MAXIMUM OPERATING PRESSURE (bar) AT 20 ° C (in combination with 5500 series fittings)	10			

BENDING RADIUS

NOMINAL DIAMETER OF THE PIPE	16x2.0	20x2.0	26x3.0	32x3.0
MANUAL mm	80	100	130	-
WITH INTERNAL SPRING mm	45	60	95	-
WITH BENDER mm	X			

SHEATH TECHNICAL CHARACTERISTICS

NOMINAL DIAMETER OF THE PIPE	16x2.0	20x2.0	26x3.0	32x3.0
OPERATING TEMPERATURE	-30 °C ; + 95°C			
DENSITY	33 Kg/m ³			
COEFFICIENT OF THERMAL CONDUCTIVITY (at 40 ° C)	0.0397 W/(m*K)			
RESISTANCE TO THE DIFFUSION OF WATER VAPOR	> 6000			
FIRE RESISTANCE CLASSIFICATION	class 1			

REGULATIONS

• ISO 21003-3

It is the European standard for multilayer pipes for hot and cold water in installations inside homes. This legislation specifies the general characteristics of pipes and multilayer systems for conveying hot and cold water inside homes in heating and drinking water systems

CERTIFICATIONS

KIWA-DVGW in accordance with UNI EN ISO 21003.

The new regulation requires the marking to report only the classes of applications and temperatures of the pipe project. Any other indication of temperature and pressure is confusing

General Fittings pipe, certified by prestigious bodies, finds its application in continuous hot water supplies at 70 ° C.

General Fittings pipe is therefore guaranteed for continuous operation of hot water supply at 70 ° C for 49 years and, for one year at 80 ° C, for 100h at 95 ° C, the latter considered as a malfunction temperature.

MARKINGS

Pex/Sheath	MARKING
Tube	> < M 001 A03 General Fittings Dn. PIPE SIZE PE-Xb AI PE-Xb ISO 21003 Class 2-5/10 bar - Max 90°C KIWA CODE KIWA DVGW CODE DVGW Sanitary and Heating - Made in Italy - DATE HOUR - BATCH
Codes: TB0020G202000H, TB0020G263000H, TB0020R202000H, TB0020R263000H, TB0020B202000H, TB0020B263000H	> < M 001 A03 General Fittings COLORETherm Dn. PIPE SIZE + SHEATH THICKNESS mm - Made in Italy - DATE HOUR - BATCH
Blue, red and gray sheath	> < M 001 A03 General Fittings COLORETherm Dn. PIPE SIZE + SHEATH THICKNESS mm L10/91 CL.1 - Made in Italy - DATE HOUR- BATCH
White frio sheath	> < M 001 A03 General Fittings WhiteFrio Dn. PIPE SIZE + SHEATH THICKNESS mm L10/91 CL.1 - Made in Italy - DATE HOUR- BATCH

PRESSURE DROPS

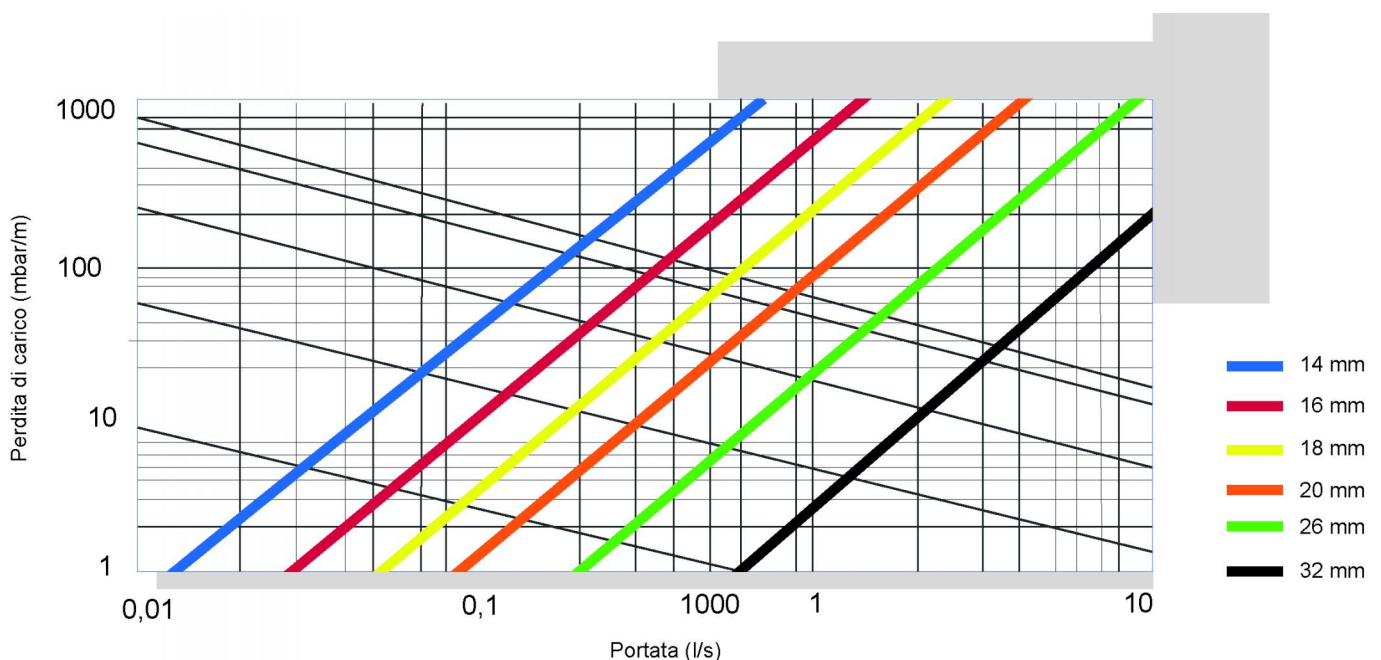

FITTINGS

Both radial press fittings and compression fittings are available to be used with PEX-b / AI / PEX-b multilayer pipes.

Given the wide range of fittings offered by General Fittings, we recommend that you refer to the commercial catalogue or the website www.generalfittings.it.

THERMAL EXPANSION

During the design and installation phases of PEX-b / Al / PEX-b multilayer pipes, the phenomenon of thermal expansion must not be neglected.

Through the table below it is possible to make the appropriate assessments. Thermal expansion can be evaluated using the formula: $\Delta L = \alpha \times L \times \Delta t$ where

ΔL = expansion expressed in mm

α = coefficient of linear thermal expansion, which corresponds to 0.026 mm / m K

L = length of the pipe expressed in m

Δt = temperature variation expressed in degrees Kelvin [K] or Celsius [° C]

PIPE LENGTH (m)	TEMPERATURE DIFFERENCE (K)							
	10	20	30	40	50	60	70	80
1	0.26	0.52	0.78	1.04	1.3	1.56	1.82	2.08
2	0.52	1.04	1.56	2.08	2.6	3.12	3.64	4.16
3	0.78	1.56	2.34	3.12	3.9	4.68	5.46	6.24
4	1.04	2.08	3.12	4.16	5.2	6.24	7.28	8.32
5	1.3	2.6	3.9	5.2	6.5	7.8	9.1	10.4
6	1.56	3.12	4.68	6.24	7.8	9.359	10.92	12.48
7	1.82	3.64	5.46	7.28	9.1	10.92	12.74	14.56
8	2.08	4.16	6.24	8.32	10.4	12.48	14.56	16.64
9	2.34	4.68	7.02	9.359	11.7	14.04	16.38	18.72
10	2.6	5.2	7.8	10.4	13	15.6	18.2	20.8
	LINEAR EXPANSION (mm)							

THERMAL AND ACOUSTIC INSULATION

The multilayer pipes for hot and cold water (or other heat transfer fluid) must be adequately insulated to comply with specific regulations in terms of thermal and acoustic insulation as well as to absorb in cases where any expansion of the pipeline is possible. Since the thickness and sizing varies according to the concerned environments, the minimum thickness for the insulation materials is shown in the table.

Once the diameter of the pipe and the value of the useful thermal conductivity of the insulation (expressed in $W / m \text{ } ^\circ C$ at a temperature of $40 \text{ } ^\circ C$) are known, the minimum thicknesses to be applied in the most common cases can be obtained.

All ducts must be acoustically insulated to avoid the transmission of noise; it is always suggested to detach the risers from the building, where possible use specific support collars and bandage them with materials suitable for reducing acoustic bridges.

Thermal conductivity of the insulation ($W / m \text{ } ^\circ C$)	Outside diameter of the pipe (mm)					
	< 20	From 20 to 39	From 40 to 59	From 60 to 79	From 80 to 99	> 100
0.030	13	19	26	33	37	40
0.032	14	21	29	36	40	44
0.034	15	23	31	39	44	48
0.036	17	25	34	43	47	52
0.038	18	28	37	46	51	56
0.040	20	30	40	50	55	60
0.042	22	32	43	54	59	64
0.044	24	35	46	58	63	69
0.046	26	38	50	62	68	74
0.048	28	41	54	66	72	79
0.050	30	42	56	71	77	84

FLUIDS AND REAGENTS

Fluid	%	20°C	60°C	80°C
Acetic acid	60	C		
Glacial acetic acid	>96	C	L	
Vinager	-	C		-
Acetone	liquid	S	-	L
Adipic acid	Sol.Sat	C		-
Air	-	C		
Acetate silver	Sol.Sat	C		-
Nitrate silver	Sol.Sat	C		-
Allyl Alcohol	liquid	-	NC	-
Methyl alcohol	5	C		-
Methyl alcohol	liquid	C		-
Alum	Sol. Sat.	C		-
Aluminium (chlorate)	Sol. Sat.	C		-
Aluminum (fluorinated)	Sol. Sat.	C		-
Aluminum (nitrate)	Sol. Sat.	C		-
Aluminum (potassium sulf.)	Sol. Sat.	C		
Ammonia	Sol. Sat.	C		-
Ammonia	gas	C		-
Ammonium Carbonate	Sol. Sat.	C		-
Ammonium (chloride)	Sol. Sat.	C		-
Ammonium (carbonate)	Sol. Sat.	C		-
Ammonium (nitrate)	Sol. Sat.	C		
Ammonium (sulfate)	Sol. Sat.	C		
Amyl Acetate	liquid	L		
Amile alcohol	liquid	C		-
aqua regia	HCl/HNO ₃ 3/1	NC		
Barium (bromate)	Sol. Sat.	C		
Barium (carbonate)	Sosp.	C		
Barium (chloride)	Sol. Sat.	C		
Barium (hydroxide)	Sol. Sat.	C		
Barium (sulfate)	Sosp.	C		
Barium (sulphite)	Sol. Sat.	C		
Benzaldehyde	liquid	L	NC	

Fluid	%	20°C	60°C	80°C
Benzene	liquid	C	-	
Benzoic (acid)	Sol. Sat.	C		-

DATA SHEET

Beer	-	C		
Bismuth carbonate	Sol. Sat.	C		
Borax	Sol.	C		
Borax	Sol. Sat.	C		
Boric (acid)	Sol. Sat.	C		
Bromine	gas	NC		
Bromine	liquid	NC		
Butane	gas	C		-
n-Butane	liquid	C	L	-
Butyl (acetate)	Liquid	L		-
Butyl (glycol)	liquid	C		-
Butyric (acid)	liquid	L		-
Calcium (carbonate)	Sosp.	C		
Calcium (chlorate)	Sol. Sat.	C		
Calcium (hydroxide)	Sol. Sat.	C		-
Calcium (hypochlorite)	Solution	C		-
Calcio (nitrato)	Sol. Sat.	C		
Calcium (sulfate)	Sosp.	C		
Camphor (oil)	Liquid	NC		
Carbon (dioxide)	Sol. Sat.	C		-
Carbon (dioxide)	gas	C		-
Carbon (monoxide)	gas	C		-
Carbon (tetrachloride)	Liquid	L	NC	
Chlorine	gas	NC		-
Chlorine	Sol. Sat.	NC		-
Chloroform	liquid	NS		-
Hydrochloric acid				

Fluid	%	20°C	60°C	80°C
Ferric chloride	Sol. Sat.	C		
Ferric nitrate	Sol. Sat.	C		-
Ferric sulfate	Sol. Sat.	C		-
Ferrous chloride	Sol. Sat.	C		-
Ferrous sulfate	Sol. Sat.	C		-
Fluorine gas	Sol. Sat.	NC		
Formic (acid)	10-100	C		-
Phosphoric (acid)	Up to 50	C		-
Freon	Sol.	C	-	
Diesel fuel	liquid	C	L	-
Glucose	Sol.	C		
Glycerine	liquid	C		-
Hydrogen	gas	C		-
Hydrogen peroxide	10	C		-
Hydrogen peroxide	30	C	L	-
Hydrogen peroxide	90	C	NC	-
Hydrogen sulphide	gas	C		-
Iodine	Sol. Sat.	NC		-
Milk	Sol.	C		
Lactic (acid)	liquid	C		-
Magnesium carbonate	Sosp.	C		-
Magnesium chlorate	Sol. Sat.	C		-
Magnesium hydroxide	Sol. Sat.	C		-
Magnesium nitrate	Sol. Sat.	C		-
Magnesium sulfate	Sol. Sat.	C		-
Naphtha	Sol.	C		L
Nitric acid	0-35	C	L	-
Nitric acid	>40	NC		-
Mineral oils	Sol.	C		L
Vegetable oils	liquid	C	L	-
Oxygen	gas	C	L	-
Ozone	Sol. Sat.	L	NS	-
Picric (acid)	Sol. Sat.	C	L	-
Potassium dichromate	Sol. Sat.	C		-

DATA SHEET

Fluid	%	20°C	60°C	80°C
Potassium bicarbonate	Sol. Sat.	C		-
Potassium dichromate	Sol. Sat.	C		-
Potassium bisulfate	Sol. Sat.	C		-
Potassium bromide	Sol, Sat.	C		-
Potassium carbonate	Sol. Sat.	C		-
Potassium chlorate	Sol. Sat.	C		-
Potassium chloride	Sol. Sat.	C		-
Potassium hydroxide	Up to 50	C		
Potassium hypochlorite	Sol.	C	L	-
Potassium nitrate	Sat. Sol.	C		-
Potassium orthophosphate	Sat. Sol.	C		-
Potassium permanganate	Sat. Sol.	C		-
Potassium sulfate	Sat. Sol.	C		-
Propionic (acid)	Up to 50	C		-
Copper chloride	Sol. Sat.	C		
Cyanate copper	Sol. Sat.	C		-
Copper nitrate	Sol. Sat.	C		-
Copper sulfate	Sol. Sat.	C		-
Salicylic (acid)	Sol. Sat.	C		-
Sodium acetate	Sol. Sat.	C		-
Sodium benzoate	Sol. Sat.	C		-
Sodium bicarbonate	Sol. Sat.	C		-
Sodium bicarbonate	Sol. Sat.	C		-
Sodium bisulfate	Sol. Sat.	C		-
Sodium bromide	Sol. Sat.	C		-
Sodium carbonate	Up to 50	C		-
Sodium chloride	Sol. Sat.	C		-
Sodium chromate	Sol. Sat.	C		-
Sodium hydroxide	From 1 to 60	C		-
Sodium hypochlorite	From 10 to 15	C		-

Fluid	%	20°C	60°C	80°C
Sodium nitrate	Sat. Sol.	C		-
Sodium nitrite	Sat. Sol.	C		-
Sodium phosphate	Sol. Sat.	C		-
Sodium silicate	Sol. Sat.	C		-
Sodium sulfate	Sol. Sat.	C		-
Sodium sulfate	Sol. Sat.	C		-
Sulfuric acid	Up to 50	C		-
Sulfuric acid	From 50 to 98	C	L	NC
Fruit juice	Sol.	C		-
Photographic development	Sol.	C		-
Acid tannic	Sol.	C		-
Toluene	liquid	C	L	-
Trichlorethylene	Liquid	L	NC	
Urea	Sol. Sat.	C		-
Urine	Sol.	C		-
Wine	Sol.	C		-
Zinc carbonate	Sosp.	C		-
Chlorinated zinc	Sol. Sat.	C		-
Zinc nitrate	Sol. Sat.	C		-
Zinc oxide	Sosp.	C		-
Zinc sulfate	Sol. Sat.	C		-

LEGEND

C	compatible
L	limitedly compatible
NC	Incompatible

PIPES INSTALLATION

To facilitate quick sizing of the sanitary water network, an hypothesis is reported below (load units serving the various users).

In the case of above-average adduction for connection to individual users, check with the pressure drop diagrams that the minimum requirements for flow rate, pressure drop and water speed are met.

CONSUMPTION	CONNECTOR	Ø EXTERNAL PIPE	Ø INTERNAL PIPE
Kitchen sink	1/2"	16x2.0 mm	Ø 12mm
Service sink	1/2"	16x2.0 mm	Ø 12mm
Bathroom sink	1/2"	16x2.0 mm	Ø 12mm
Bidet	1/2"	16x2.0 mm	Ø 12mm
Shower	3/4"	20x2.0 mm	Ø 16mm
Cabinet	3/4"	20x2.0 mm	Ø 16mm
Distribution rising columns	3/4"	20x2.0 mm	Ø 16mm
Distribution rising columns	3/4"	26x3.0 mm	Ø 16mm
Distribution rising columns	1"	32x3.0 mm	Ø 20mm
Distribution rising columns	1" 1/4	40x3.50 mm	Ø 33mm
Distribution rising columns	1" 1/2	50x4.00 mm	Ø 42mm
Distribution rising columns	2"	63x4.50 mm	Ø 54mm

To lay the pipes, it is necessary to follow some simple precautions concerning the connection of the pipe using the appropriate fittings and adapters, the bends of the pipes, the protection from sunlight and possible damage:

- the connection of the pipes to the distribution manifolds or to the elbows for the connection of taps must be made by means of fittings and adapters of suitable size for the pipe used
- the connection of the pipes to the manifold must be carried out in such a way as to avoid that the components are subjected to permanent mechanical stress
- all the materials used to manufacture the pipes expand when heated and shrink when cooled: for this reason, the length variation (ΔL) generated by temperature variations must always be taken into account during installation (see paragraph " Thermal expansion ")
- When installing exposed pipes, the length of the pipes must be calculated based on the system requirements, and the distances between the pipe supports must be carefully evaluated. The maximum distance between each support (L) depends on the diameter of the pipe used and is summarized in the following table.

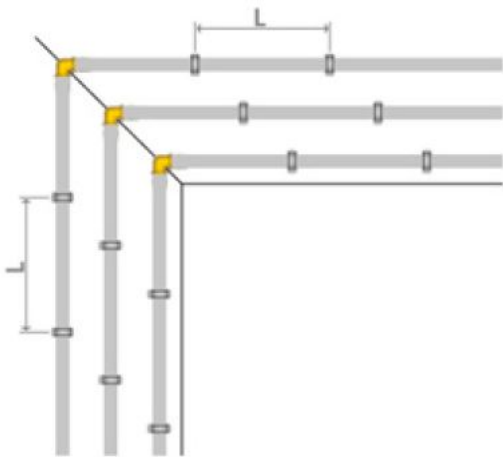

Ø EXTERNAL OF THE PIPE mm	MAX DISTANCE BETWEEN EACH SUPPORT (L) mm
16	1000
18	1100
20	1250
26	1500
32	2000
40	2250
50	2500
63	2760
75	2750
90	2750

The supports made in visible installations have two functions: they support the piping and allow its thermal expansion. The supports can be fixed, when they block the pipe, or sliding, when they allow the pipe to slide caused by thermal expansions.

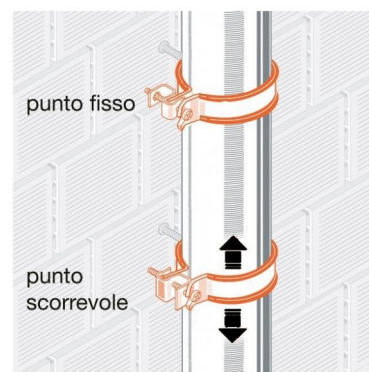

In long sections of straight piping, to absorb any variations in length, it is advisable to insert at least one expansion elbow every 10m of pipe, as shown in the following diagram. For pipes with a diameter equal to or greater than 32mm, the expansion curves are mandatory.

- L = Distance between fixed support and expansion curve
- ΔL = Change in pipe length
- F = Fixed support
- Lb = Length of the expansion arm

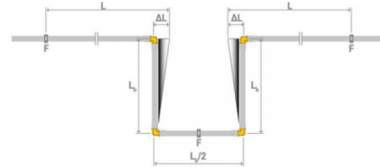

The minimum length of the expansion arm (Lb) can be calculated using the following formula $Lb = C \times \sqrt{\varnothing \times \Delta L}$

- Lb = minimum length of the expansion arm in mm
- C = material constant (for multilayer pipe the value is 33)
- \varnothing = external diameter of the pipe in mm
- ΔL = Change in pipe length in mm

When making the expansion bends, it is essential to use fittings and correctly position the fixed supports and sliding supports as shown in the following diagram. It is advisable to use expansion elbows every time the pipeline undergoes a change of direction

- L = Distance between fixed support and expansion curve
- ΔL = Change in pipe length
- F = Fixed support
- S = Sliding support
- Lb = Length of the expansion arm

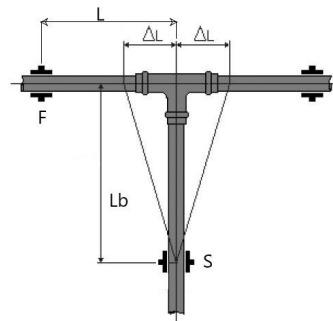

CAUTIONS

The multilayer pipes in PEX-b / Al / PEX-b require some necessary precautions to guarantee their

duration and functionality:

- keep the pipe in the appropriate packaging and store in covered, dry places to prevent moisture from damaging it;
- do not expose directly to sunrays; General Fittings multilayer pipe can be freely laid on sight inside the buildings. However, direct exposure to UV rays must be avoided as they deteriorate the polyethylene by oxidizing the surface;
- always cut the pipe to be installed with the appropriate tools capable of making a clean cut, perpendicular to the axis of the pipe and without burrs;
- after each cutting operation, and before putting on the fitting, calibrate with the appropriate tool and lubricate the sealing elements on the hose holder;
- avoid the formation of ice inside the pipe, because the expansion due to the change of state could damage it irreparably;
- avoid storage at temperatures below -30°C ;
- the pipe must never come into contact with open flames;
- once installation is complete, carry out an acceptance test at a pressure equal to 1.5 times the operating pressure;
- the bending radius when laying the pipes must be greater than 5 times the external diameter of the pipe; this value can drop to 3 times the external diameter of the pipe with pipe bending bender;
- two consecutive fittings must be installed at a sufficient distance not to generate mutual stresses on all components, both during installation and during the operation of the system;
- in visible installations the piping must always be protected from ultraviolet rays, which can alter the chemical-physical characteristics;
- prevent the piping from being exposed for long periods to solar radiation or fluorescent lamps;
- if the pipe is chased without a protective sheath, it must be covered with a screed with a thickness of at least 15 mm to avoid cracks in the plaster due to thermal expansion;
- avoid as much as possible to install concealed fittings. If this is not possible, make the fitting inspectable or protect it from contact with building material and keep track of its position in the project documentation;
- after laying the pipes and before any coverage, a pressure test of the system should be performed in order to immediately highlight any leaks;
- the pressure test must be followed by the protection of the sheaths by covering with cement in order to avoid crushing of the piping or alteration of the laying;



General Fittings Spa
Via Golgi, 73/75
25064 Gussago (BS) ITALY
Tel. +39 030 3739017
P.IVA 03448140172 - C.F. 01613110178
www.generalfittings.it