

Installation Operation Manual

Model: EAB-003 100*190
Cod Romstal:79CD4208

Model: EAB-004 80*190
Cod Romstal:79CD4210

Model: EAB-003 120*190
Cod Romstal:79CD4209

Model: EAB-004 90*190
Cod Romstal:79CD4211

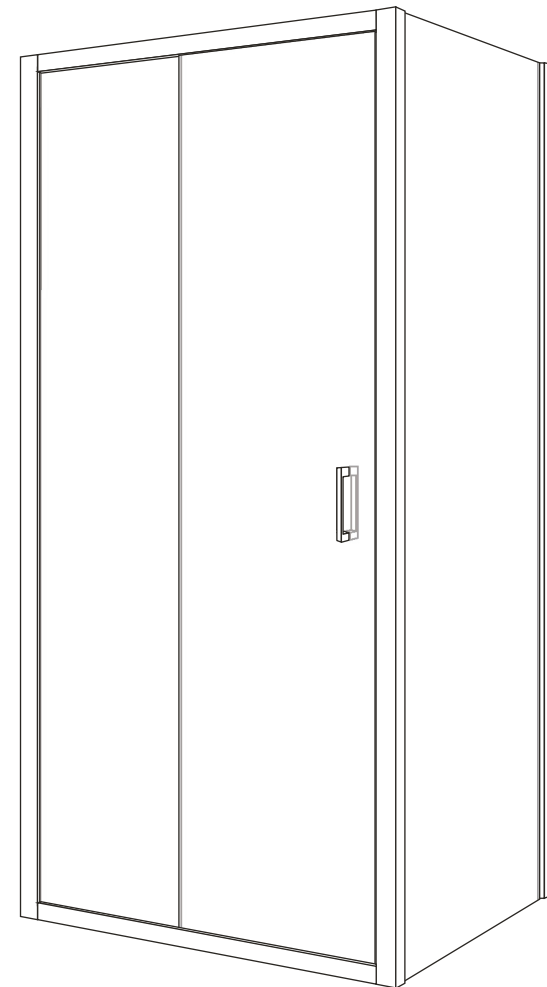







Important Reminder

1. Please install the shower enclosure according to the instruction strictly, otherwise, it will affect the operational performance.
2. After opening the carton, please check the parts according to the part list.
3. Please handle the glass parts carefully, don't knock on the glass to avoid damage.
4. After installation completely, please use it after 24 hours.

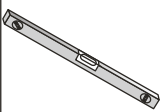

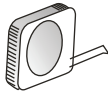
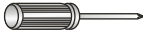

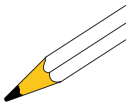





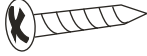

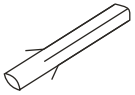

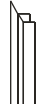
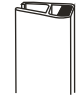

Notice

1. Do not let children, old people or disabled people enter the room alone.
2. Do not climb or hang heavy things on the shower enclosure.
3. Do not knock and impact the glass with heavy things.
4. Caution slippery on the inside of the shower enclosure.
5. Ordinary liquid detergent should be used with a soft cloth for cleaning.
6. Apply silicone to prevent water leakage.
7. Keep the tray clean, avoid hair and sundries to jam the drain.

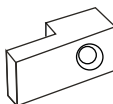
Tools:

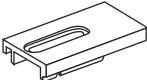
			
Spirit Level	5.5mm drill	Tape measure	Cross screw driver
			
Scissors	Silicone Gun	Pencil	Rubber mallet

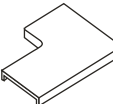
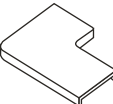
Part list

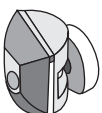
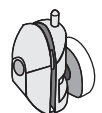
 Screws ST4X25 X8	 Screws ST4X20 X2	 Screws ST4X35 X2	 Wall plug X8
 Wall Profile X2	 X1	 X2	 X1
 X1	 X1	 Rubber Seal X2	 Magnetic Seal X1
 Handle X1	 X2	 Screws ST4X16 X2	 X2
 X2	 X1	 X1	 3mm X1
 X2	 X2		

Installation Procedure

STEP 1:

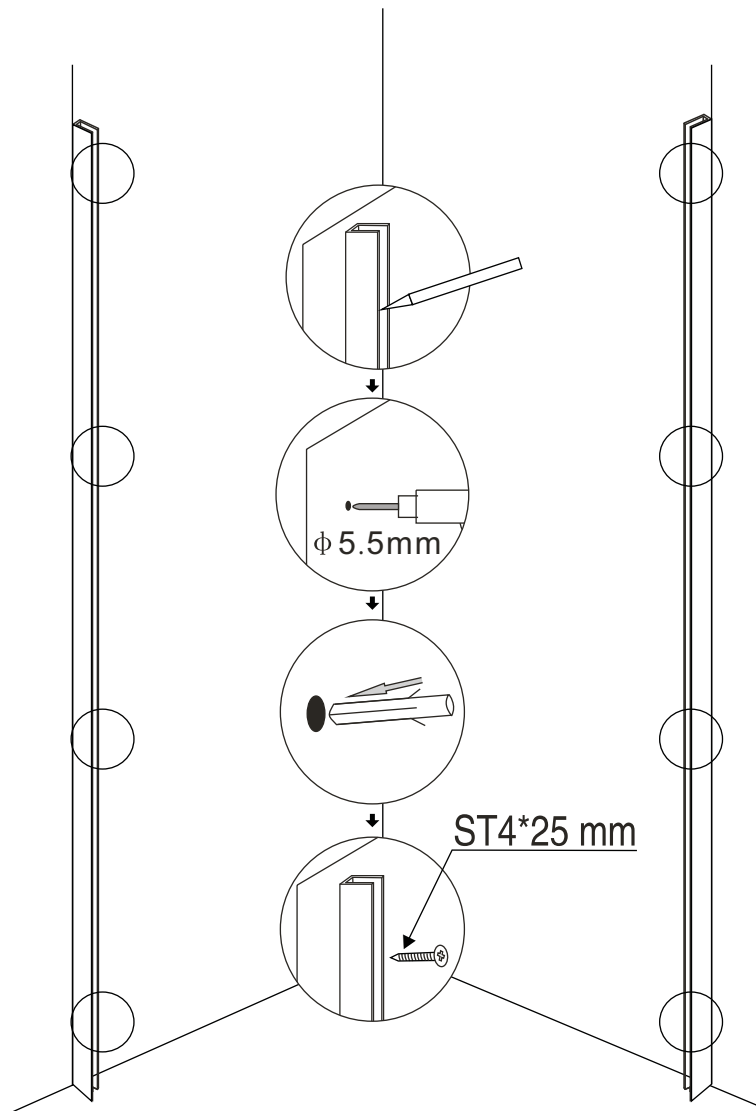

- Measure the correct distance from the corner to the required positions of the outside of the wall profiles and mark this position on the wall with a pencil.
- Position the wall profiles against these marks and use a spirit level to ensure they are vertical.
- Using the wall profiles as a template, mark the positions of the pre-drilled holes on the wall.
- Drill the positions marked using a 5.5mm drill bit.
- Use a rubber mallet to insert the wall plugs into the holes.
- Fix the wall profiles with screws 4x25mm.

STEP2:

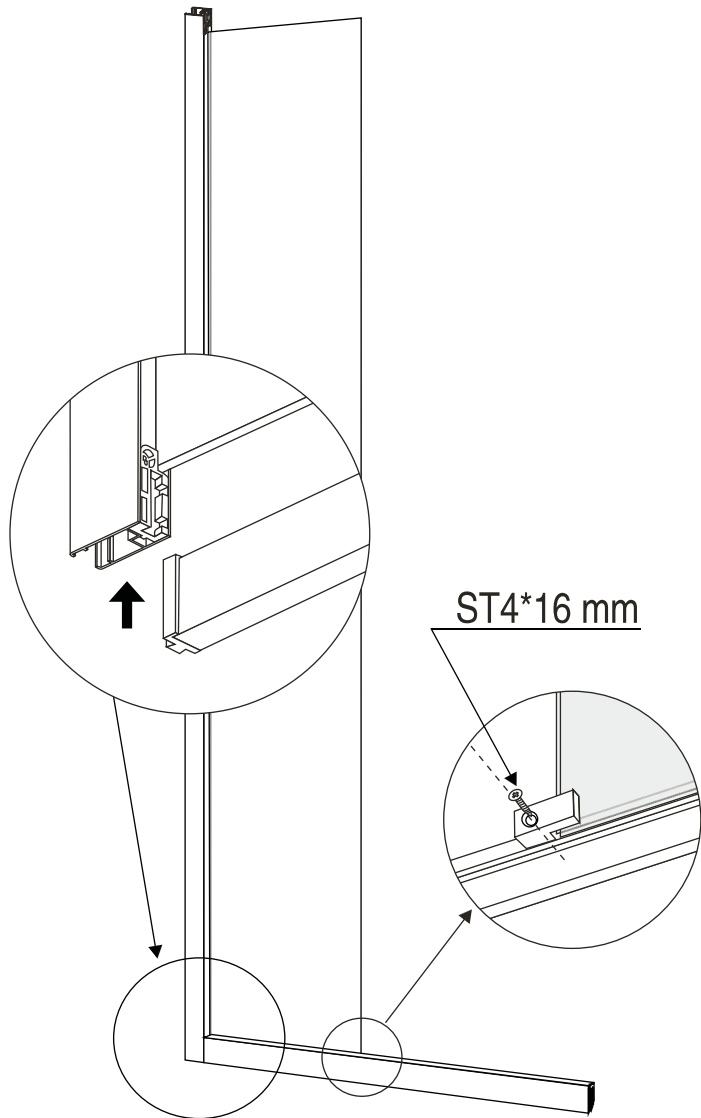

STEP3:

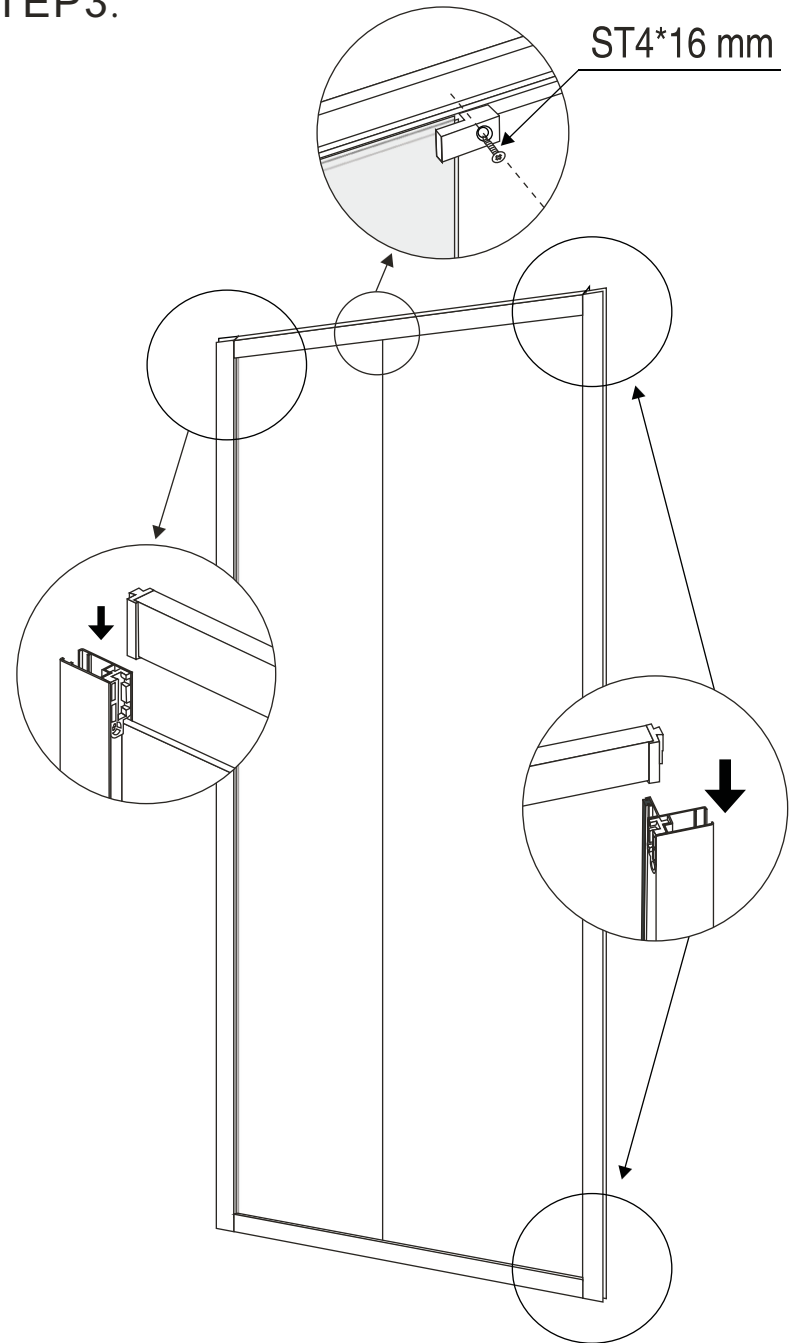

STEP4:

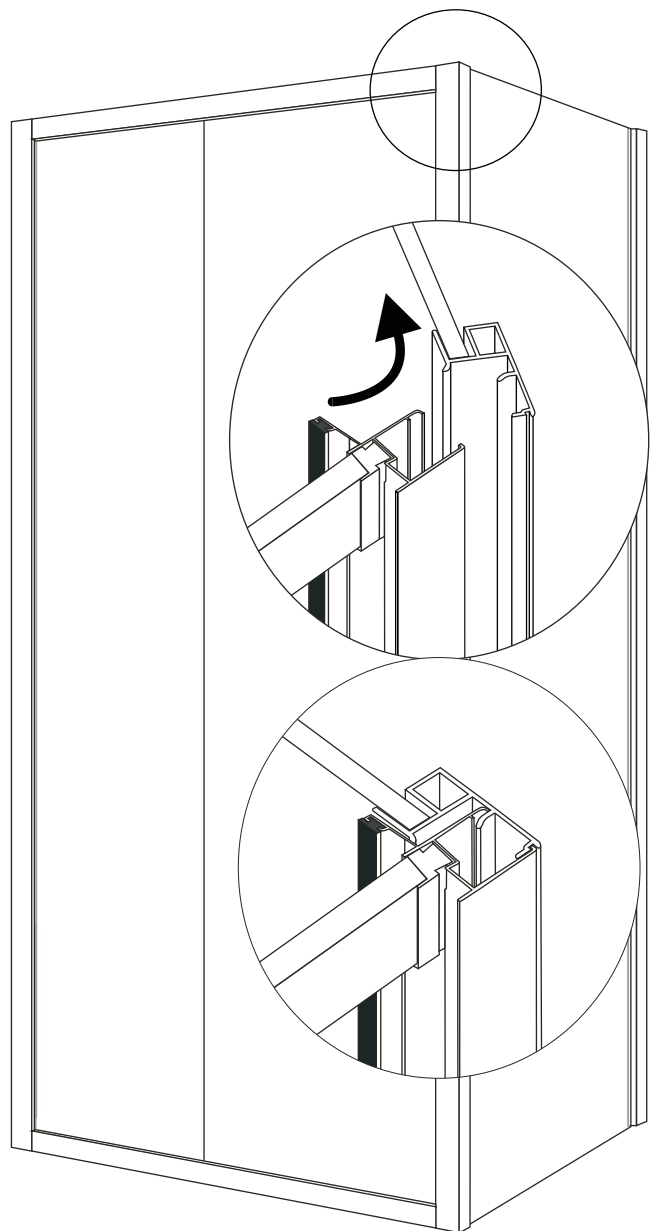

STEP5:

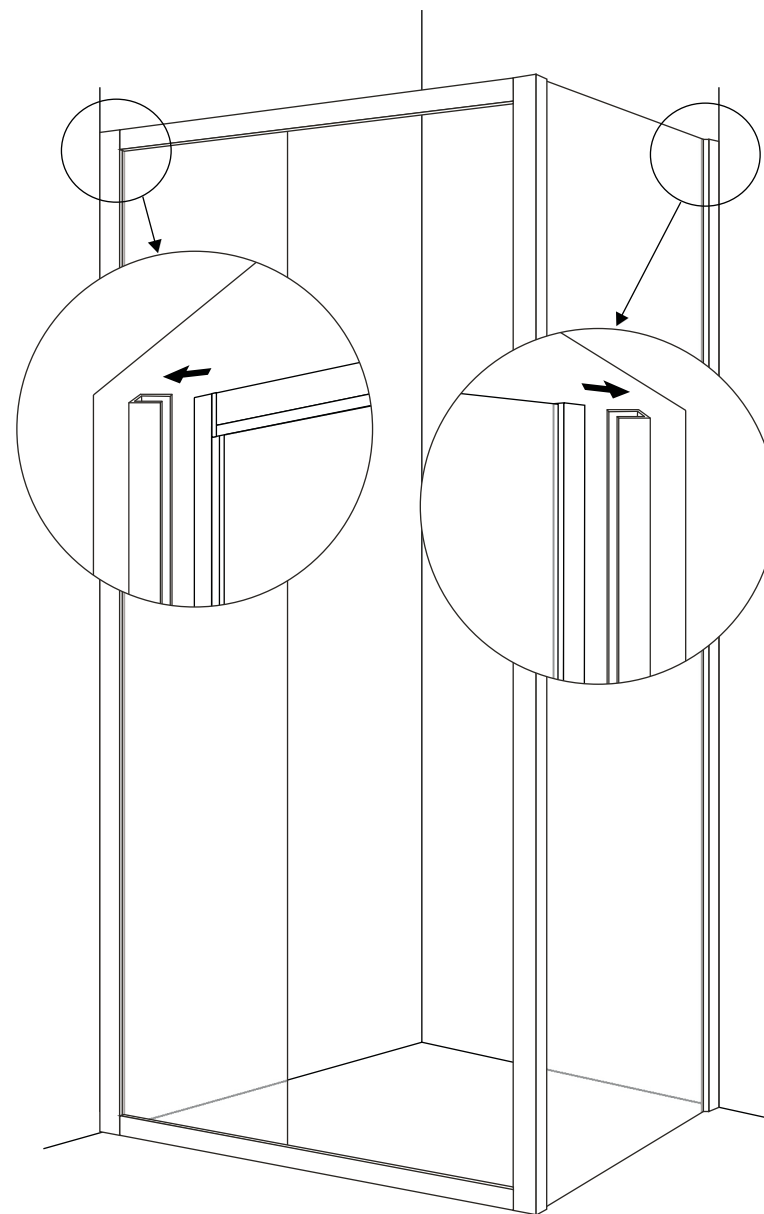

STEP6:

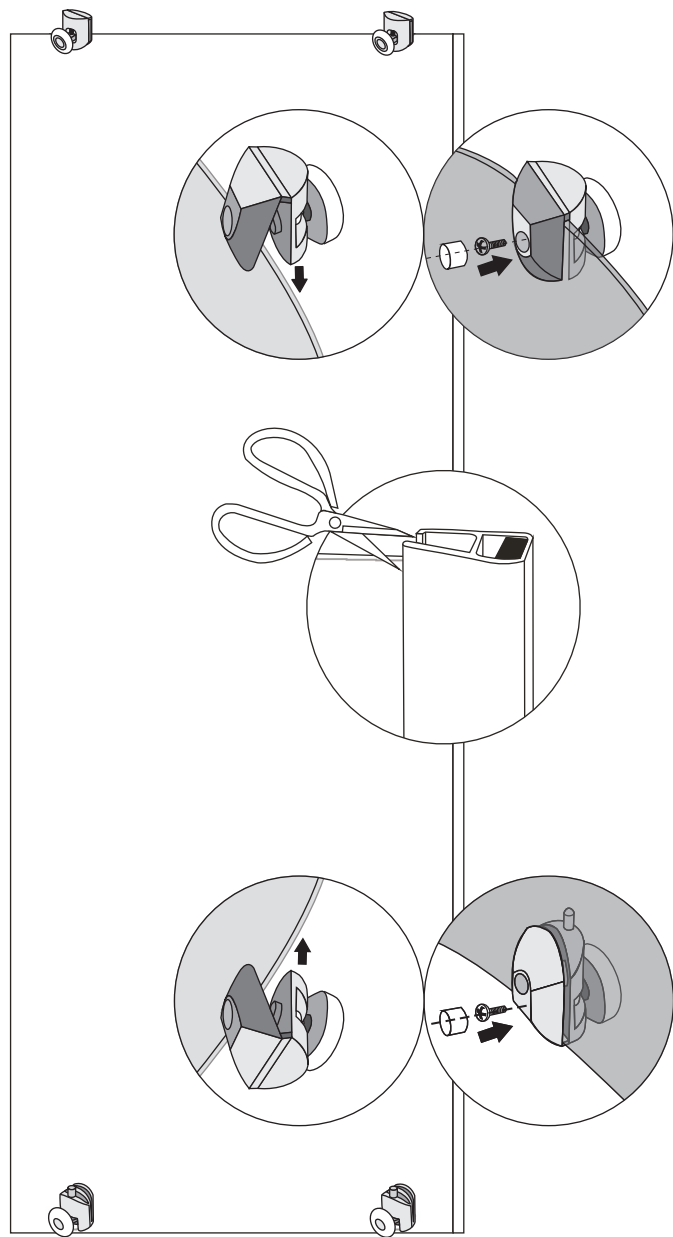

STEP7:

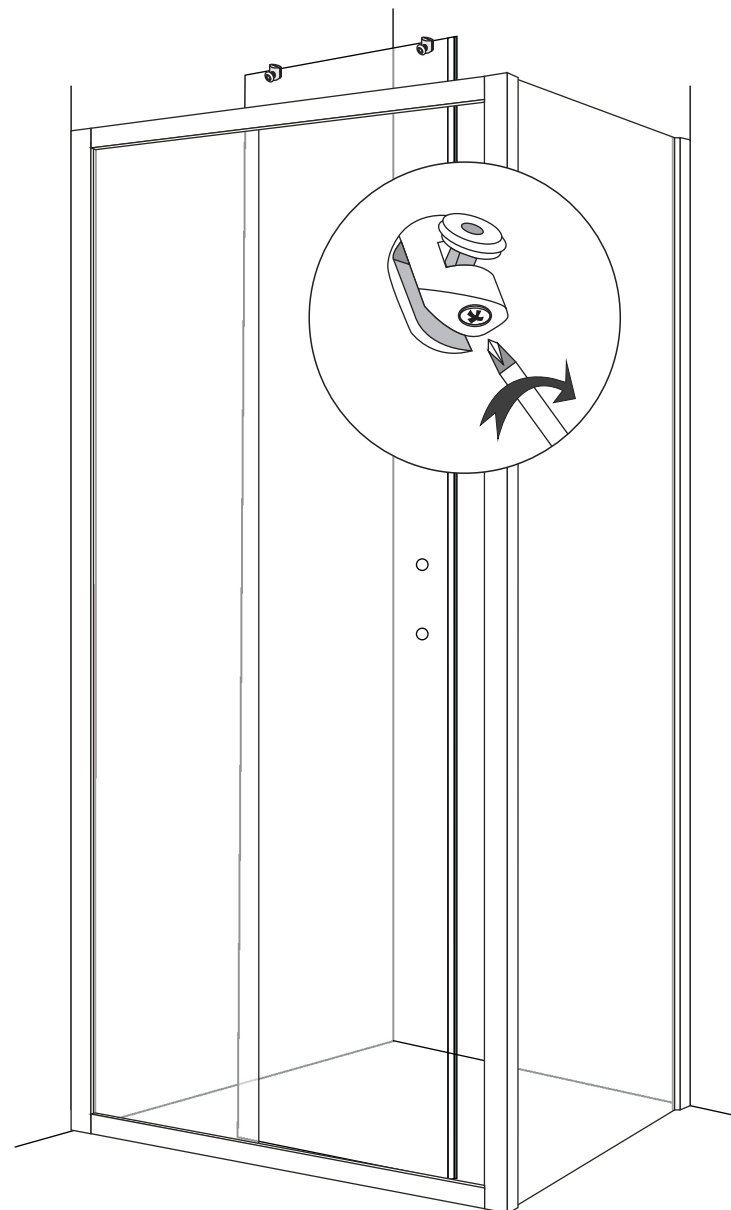

STEP8:

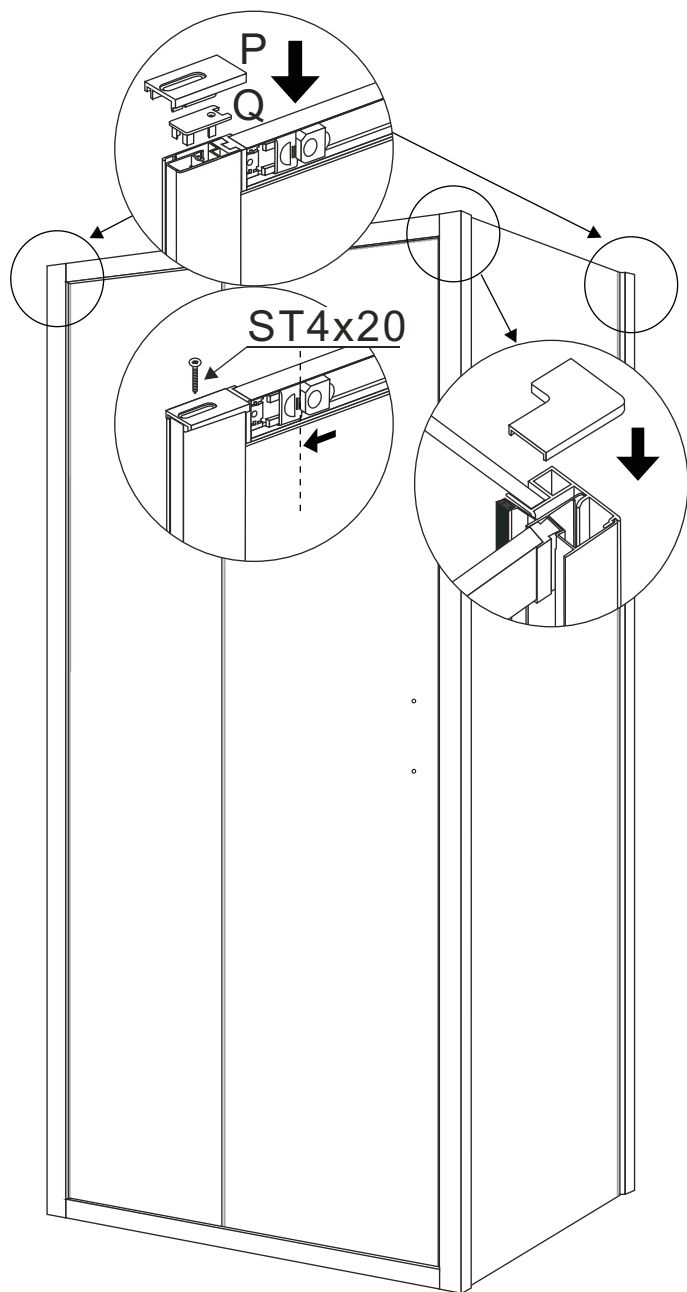

STEP9:

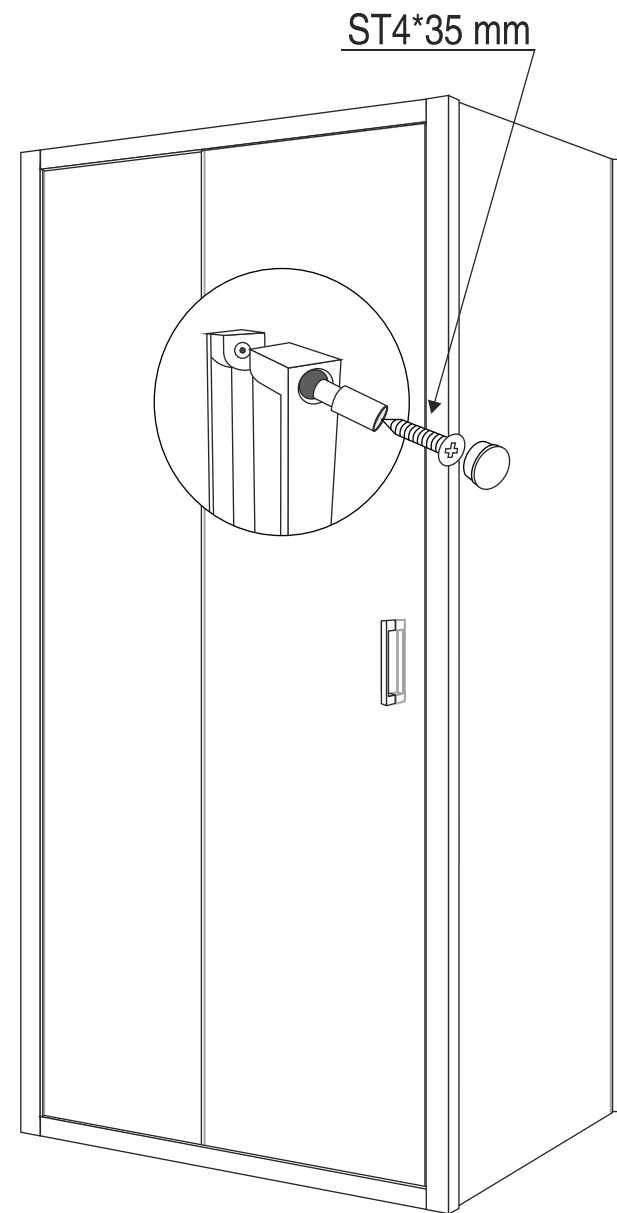

STEP 10:

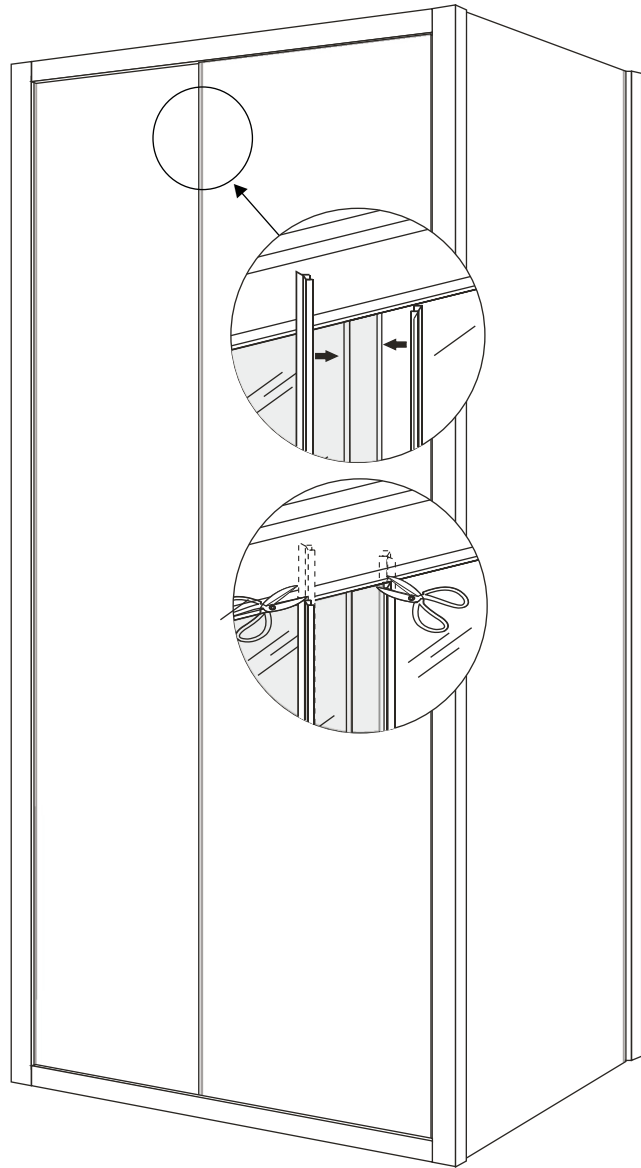

STEP 11: Silicone Application

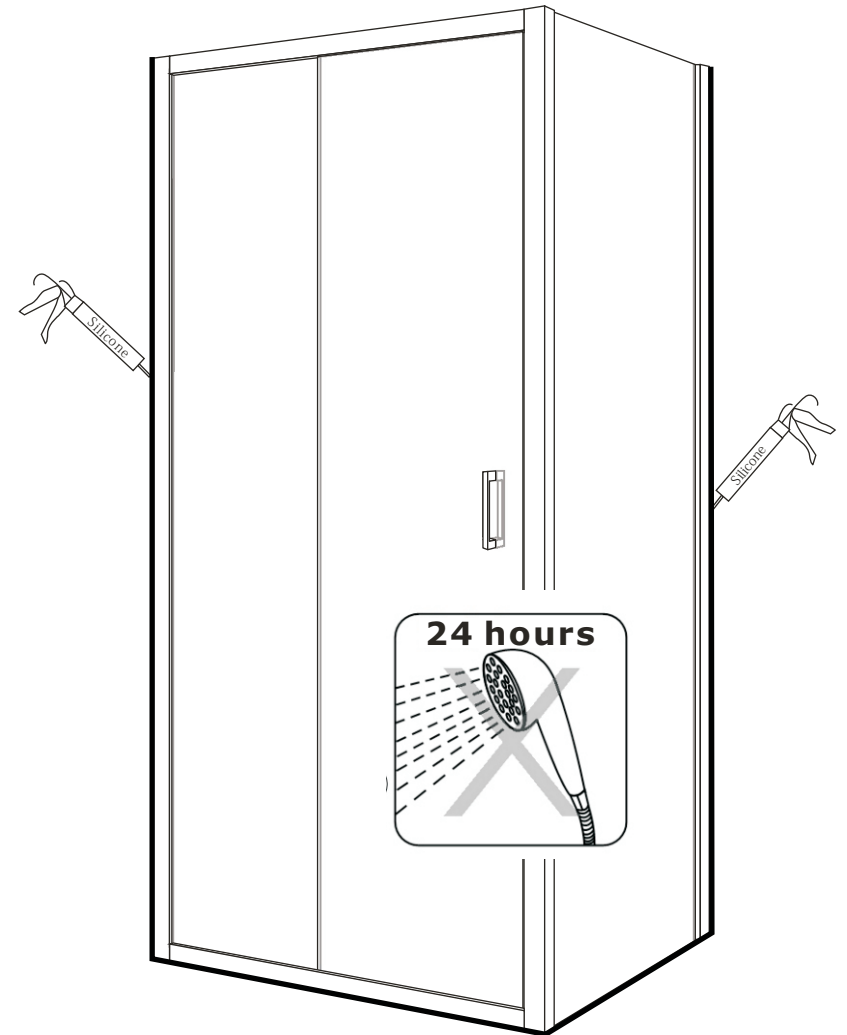

- Apply silicone sealant to all joints between wall profiles and tray.
- Do not use the enclosure for 24 hours, to allow the silicone to dry completely.