

# 1511090 Instructions of assembly

## Tool Needed

1. Tape measure(Max 3 Metre)
2. Horizontal ruler
3. Cross Screw driver
4. Electric drill
5. Hammer

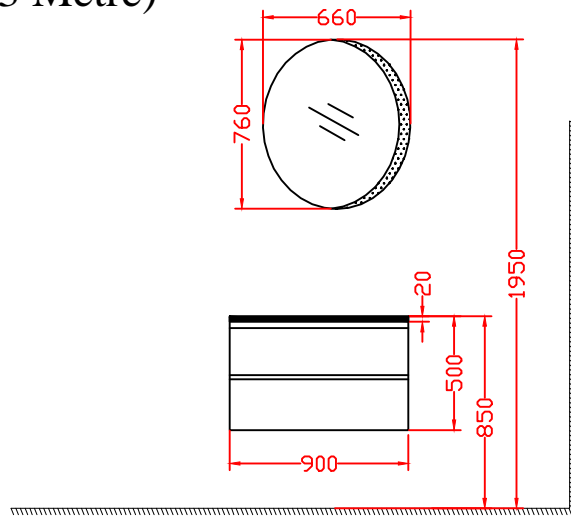

## STEP 1)

As drawing shows, make holes horizontally with drill

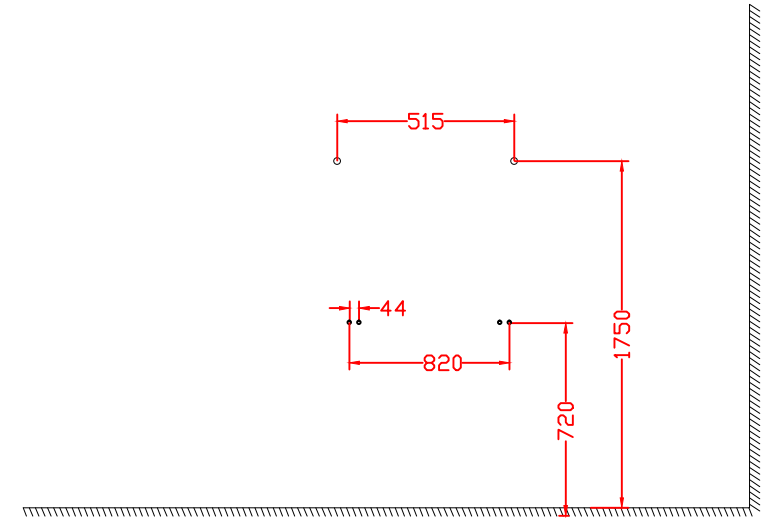

## STEP 2)

As drawing shows, fix the screw and hanger into the wall with driver horizontally

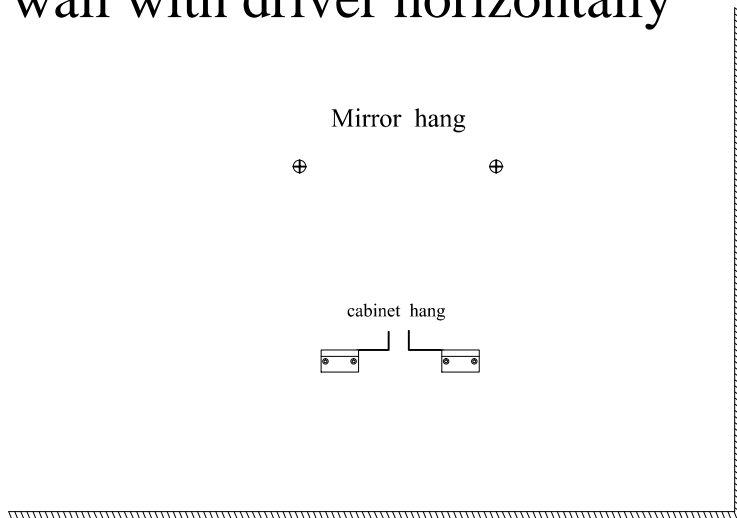

## STEP 3)

Suspending mirror and cabinets into hangers, then adjust horizontally and perfectly

