

COMBI 2

MULTI-HEAT ENERGY BUFFER WITH POLYWARM® COATED TANK IN TANK CALORIFIER FOR D.H.W. AND 1 FIXED HEAT EXCHANGER



APPLICATION

Heating hot water storage and D.H.W. production.

MATERIAL

Buffer tank: Mild steel construction with exterior paint. No anti-corrosion treatment required due to the buffer's closed circuit system.

D.H.W. storage: Mild steel Polywarm® coated (Attestation ACS - SSICA - DVGW - W270 - WRAS)

HEAT EXCHANGER

N° 1 fixed heat exchanger.

TECHNICAL DESCRIPTION

Multi-Heat Energy tanks Combi 1 are used in units with a typically discontinuous energy source for double use: heating systems and domestic hot water systems.

INSULATION

- HARD: High thermal insulation with ecological polyurethane hard foam.

- SOFT: NOFIRE® polyester fleece 100% made of recyclable material, with high thermal insulation. Fire resistance class B-s2d0 according to EN 13501.

Grey PVC external lining, complete with top and flange cover.

CATHODE PROTECTION

Chain magnesium anode

WARRANTY

5 years - See general sales conditions and warranty

ACCESSORIES AND SPARE PARTS

See Accessories section for the entire list.



POLYWARM®
COATED
DHW STORAGE



cordivari.com/erp

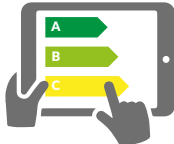

On line ErP label tool



COMBI 2 WB



Model	HARD FOAM insulation Art. Nr.	D.H.W. STORAGE		HEAT EXCHANGER		ENERGY EFFICIENCY CLASS ErP
		Volume [lt]	Surface [m²]	Volume [lt]	Surface [m²]	
500	3270162314101	99	1,1	11,5	1,9	C
600	3270162314102	146	1,3	18	2,8	C
800	3270162314103	191	1,6	20	3,1	B
1000	3270162314104	226	1,8	24	3,7	C
1500	3270162314105	412	2,5	32	4,9	C
2000	3270162314106	566	3,1	35	5,4	B



COMBI 2 WC

Model	DISMOUNTABLE SOFT FLEECE insulation Art. Nr.	D.H.W. STORAGE		HEAT EXCHANGER		ENERGY EFFICIENCY CLASS ErP
		Volume [lt]	Surface [m²]	Volume [lt]	Surface [m²]	
800	3270162284112	191	1,6	20	3,1	C
1000	3270162284113	226	1,8	24	3,7	C
1500	3270162284114	412	2,5	32	4,9	C
2000	3270162284115	566	3,1	35	5,4	C

ACCESSORIES

Thermometer

Art. Nr.	
5032240000107	
5 units box	

Chain magnesium anode (connection 3/4")

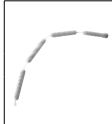
Art. Nr.	For models	
5200000041007	800÷2000	
5200000041016	500,600	
N° 2 chain anodes + insulated cap + gasket		

Buffer tanks connecting kit

Art. Nr.	Connection	
5006170001001	1" 1/2	
Stainless steel extensible connecting kit - (200 ÷ 400 mm)		

COMBI 2

MULTI-HEAT ENERGY BUFFER WITH POLYWARM® COATED TANK IN TANK CALORIFIER FOR D.H.W. AND 1 FIXED HEAT EXCHANGER

TECHNICAL STORAGE		D.H.W. STORAGE		FIXED HEAT EXCHANGER	
Pmax	Tmax	Pmax	Tmax	Pmax	Tmax
3 bar	99 °C	6 bar	90 °C	12 bar	110 °C



CORDIVARI Lab

TÜV Rheinland Energie und Umwelt GmbH states that test procedures and Cordivari LAB are certified conforming to European standard EN 15332, as indicated by Ecodesign ErP Directive.

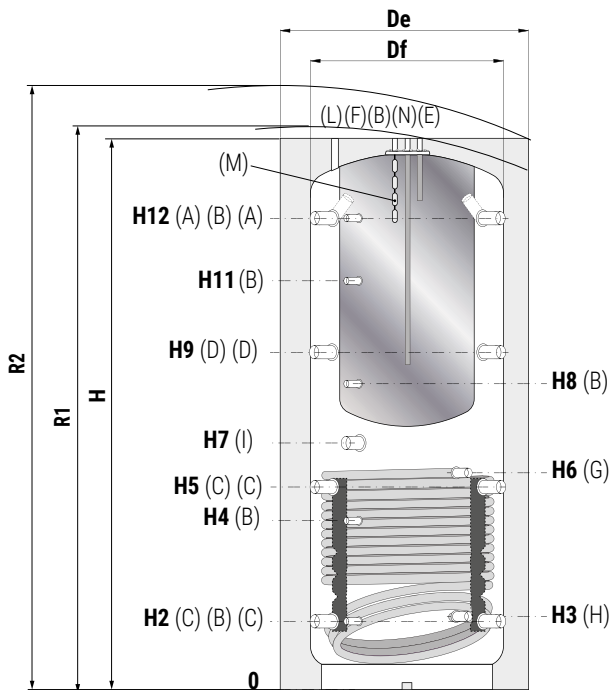
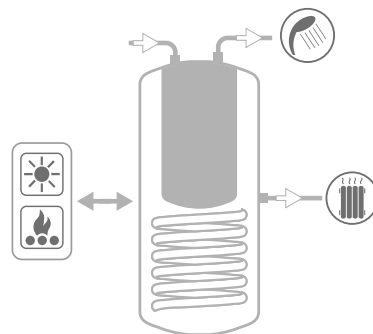

- A** Heating delivery/From generator 1"1/2 F
- B** Connection for instrumentation 1/2" F
- C** Heating return/to generator 1"1/2 F
- D** Heating delivery 1"1/2 F
- E** Domestic hot water outlet 3/4" F
- F** Domestic cold water circuit inlet 3/4" F
- G** Heat exchanger inlet 1" F
- H** Heat exchanger outlet 1" F
- I** Connection for electric immersion heater 1"1/2 F
- L** Air purge 1/2" F
- M** Chain magnesium anode 3/4" F
- N** Recirculation 3/4" F

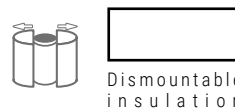
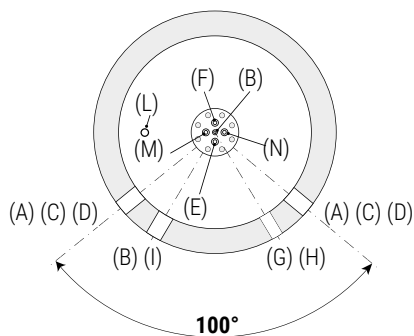

COMBI 2 WB - HARD FOAM INSULATION

Model	Volume [lt]	Df	De	H	R1	R2	H2	H3	H4	H5	H6	H7	H8	H9	H11	H12
		[mm]														
500	478	//	750	1670	//	1835	247	260	533	629	744	841	930	1011	1231	1343
600	560	//	750	1920	//	2070	247	260	582	695	855	915	1060	1144	1382	1593
800	805	790	950	1855	1900	2120	265	278	584	690	762	823	988	1115	1332	1541
1000	946	790	950	2150	2180	2380	265	284	656	787	953	998	1188	1309	1588	1831
1500	1454	//	1100	2280	//	2590	313	336	736	845	1006	1061	1286	1377	1653	1909
2000	1973	//	1300	2345	//	2715	347	370	770	879	1001	1060	1300	1411	1687	1943

COMBI 2 WC - DISMOUNTABLE SOFT FLEECE INSULATION

Model	Volume [lt]	Df	De	H	R1	R2	H2	H3	H4	H5	H6	H7	H8	H9	H11	H12
		[mm]														
800	805	790	1010	1855	1900	2090	265	278	584	690	762	823	988	1115	1332	1541
1000	946	790	1010	2150	2180	2355	265	284	656	787	953	998	1188	1309	1588	1831
1500	1454	950	1210	2280	2315	2540	313	336	736	845	1006	1061	1286	1377	1653	1909
2000	1973	1100	1360	2345	2400	2690	347	370	770	879	1001	1060	1300	1411	1687	1943



Model	COMPLETE HEATED STORAGE VOLUME				UPPER PART HEATED STORAGE VOLUME		
	DHW Volume	DHW exchanger surface	Max sanitary water produced from 10°C to 45°C with storage at 65°C and boiler on	Max sanitary water produced from 10°C to 45°C with storage at 65°C and boiler off	Max sanitary water produced from 10°C to 45°C with storage at 65°C and boiler on	Max sanitary water produced from 10°C to 45°C with storage at 65°C and boiler off	
	[lt]	[m ²]	[lt/min]	[lt]	[lt/min]	[lt]	
500	99	1,1	2,5	10 lt/min: 198 lt	1,57	10 lt/min: 148 lt	
				25 lt/min: 176 lt		25 lt/min: 132 lt	
600	146	1,3	3,0	10 lt/min: 239 lt	1,86	10 lt/min: 179 lt	
				25 lt/min: 213 lt		25 lt/min: 160 lt	
800	191	1,6	3,5	10 lt/min: 320 lt	2,17	10 lt/min: 240 lt	
				25 lt/min: 280 lt		25 lt/min: 210 lt	

LOWER HEAT EXCHANGER POWER COMBI 2 - COMBI 3

Output of the Combi 2 - Combi 3 lower heat exchangers depending on the average DeltaT between primary and accumulation considering flow rate 3 m³/h.

Thermal output is given in both kW or kcal/h in terms of average temperature difference between primary and secondary circuit, all for a range of primary 3 m³/h.

For example, a 1000 liters COMBI 2 with a water flow of 3 m³/h at 80 °C inlet and outlet at 70 °C, has on the storage of water an average temperature of 60 °C, the main difference of temperature will be:

$(80 + 70) / 20 - 60 = 15$ °C and therefore you can exchange up to approximately 32 kW.

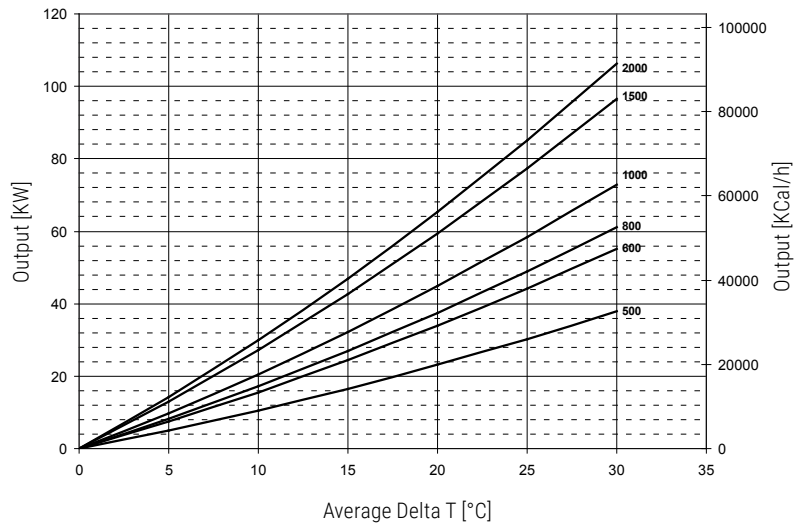

UPPER HEAT EXCHANGER POWER COMBI 3

Output of the Combi 3 upper heat exchangers depending on the average DeltaT between primary and accumulation considering flow rate 3 m³/h.

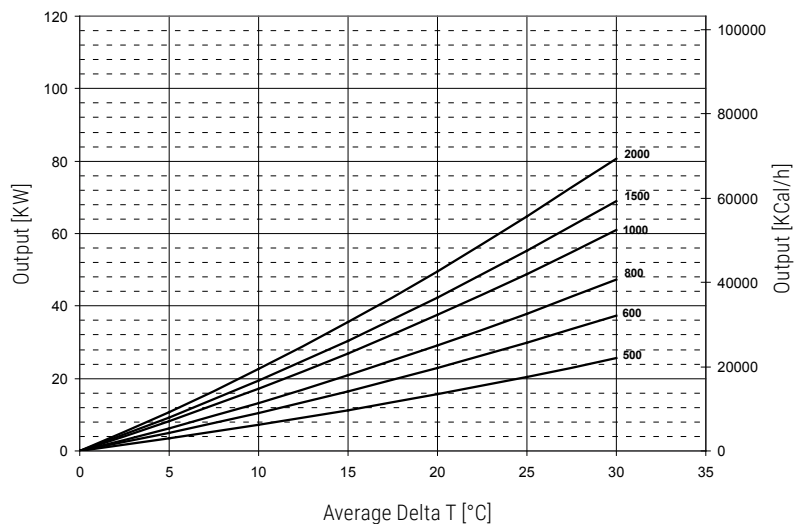

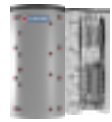

COMPLETE HEATED STORAGE VOLUME

UPPER PART HEATED STORAGE VOLUME

Model	DHW Volume	DHW exchanger surface	Max sanitary water produced from 10°C to 45°C with storage at 65°C and boiler on	Max sanitary water produced from 10°C to 45°C with storage at 65°C and boiler off	Max sanitary water produced from 10°C to 45°C with storage at 65°C and boiler on	Max sanitary water produced from 10°C to 45°C with storage at 65°C and boiler off
	[lt]	[m ²]	[lt/min]	[lt]	[lt/min]	[lt]
1000	226	1,8	4,1	10 lt/min: 389 lt	2,26	10 lt/min: 291 lt
				25 lt/min: 330 lt		25 lt/min: 250 lt
1500	412	2,5	5,6	10 lt/min: 753 lt	3,36	10 lt/min: 565 lt
				25 lt/min: 614 lt		25 lt/min: 461 lt
2000	566	3,1	6,8	10 lt/min: 1083 lt	4,08	10 lt/min: 812 lt
				25 lt/min: 852 lt		25 lt/min: 639 lt

LOWER HEAT EXCHANGER PRESSURE LOSS COMBI 2 - COMBI 3

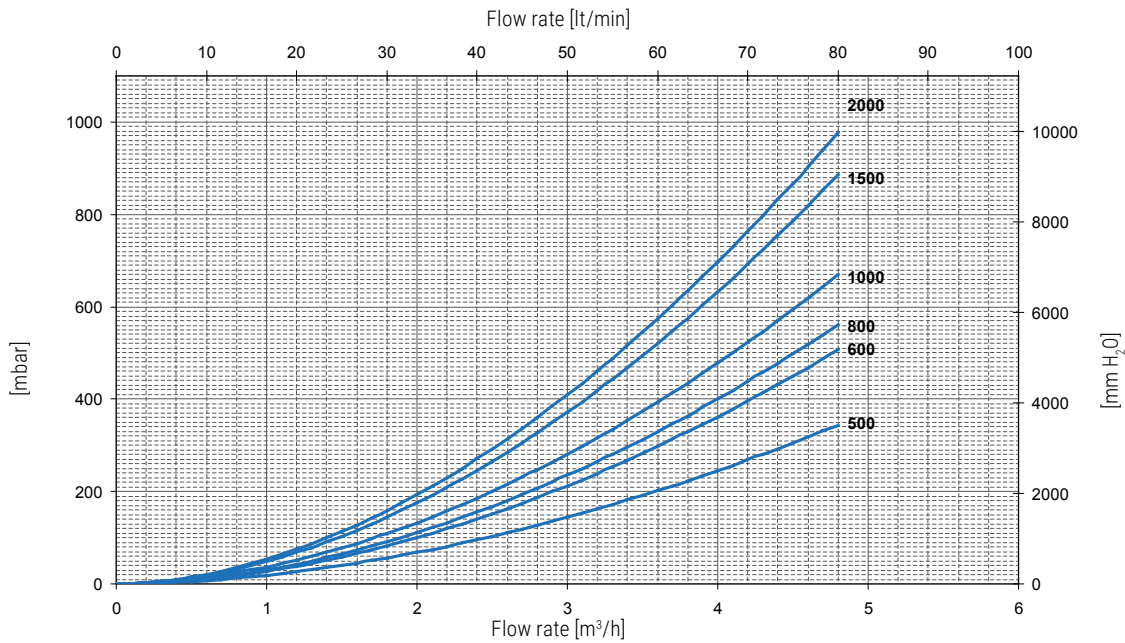

UPPER HEAT EXCHANGER PRESSURE LOSS COMBI 3

