

# Engineering Data

## Medium Static Pressure Duct

### VRF IDU



MIH15T2N18

MIH71T2N18

MIH22T2N18

MIH80T2N18

MIH28T2N18

MIH90T2N18

MIH36T2N18

MIH112T2N18

MIH125T2N18

MIH45T2N18

MIH140T2N18

MIH56T2N18

MIH160T2N18





# Medium Static Pressure Duct

<b>1 Specifications .....</b>	<b>4</b>
<b>2 Dimensions.....</b>	<b>7</b>
<b>3 Unit Placement.....</b>	<b>9</b>
<b>4 Piping Diagram .....</b>	<b>10</b>
<b>5 Wiring Diagram .....</b>	<b>11</b>
<b>6 Capacity Tables.....</b>	<b>13</b>
<b>7 Electrical Characteristics .....</b>	<b>14</b>
<b>8 Sound Levels .....</b>	<b>15</b>
<b>9 Fan Performance .....</b>	<b>18</b>

## 1 Specifications

Table 1.1: MIH15(22,28,36)T2N18 specifications

Model			MIH15T2N18	MIH22T2N18	MIH28T2N18	MIH36T2N18
Power supply			1-phase, 220-240V, 50Hz			
Cooling <sup>1</sup>	Capacity	kW	1.5	2.2	2.8	3.6
		kBtu/h	5.1	7.5	9.6	12.3
	Power input	W	33	36	40	50
Heating <sup>2</sup>	Capacity	kW	1.8	2.5	3.2	4
		kBtu/h	6.1	8.5	10.9	13.7
	Power input	W	33	36	40	50
Fan motor type			DC			
Indoor coil	Number of rows		2	2	2	2
	Tube pitch	mm	18×10.72			
	Fin spacing and type	mm	1.35 Hydrophilic aluminum			
	Tube OD and type	mm	Φ5 Inner-groove			
	Dimensions (L×H×W)	mm	400×21.44×360			
	Number of circuits		5	5	5	5
Air flow rate <sup>3</sup>		m <sup>3</sup> /h	470/438/407/375/3 43/312/280	500/467/433/400/3 67/333/300	540/503/467/430/ 393/357/320	575/535/495/455/ 415/375/335
External static pressure <sup>4</sup>		Pa	30 (10-160)			
Sound pressure level <sup>5</sup>		dB(A)	26.5/26/25/24/23/2 2.5/22	26.5/26/25/24/23/2 2.5/22	26.5/26/25/24/23/ 22.5/22	29/28/27/26/25/2 3/22
Sound power level		dB(A)	46/44.5/43/41.5/40 /38.5/37	47/45.5/44/42.5/41 /39.5/38	47/45.5/44/42.5/4 1/39.5/38	50/48.5/47/45/43/ 41/39
Unit	Net dimensions <sup>6</sup> (W×H×D)	mm	600×245×750			
	Packed dimensions (W×H×D)	mm	765×305×885			
	Net/Gross weight	kg	18.5/21			
Refrigerant type			R410A/R32			
Throttle type			Electronic expansion valve			
Design pressure (H/L)		MPa	4.4/2.6			
Pipe connections	Liquid/Gas pipe	mm	Φ6.35/Φ12.7			
	Drain pipe	mm	OD Φ25			

Notes:

- Indoor temperature 27°C DB, 19°C WB; outdoor temperature 35°C DB; equivalent refrigerant piping length 7.5m with zero level difference.
- Indoor temperature 20°C DB; outdoor temperature 7°C DB, 6°C WB; equivalent refrigerant piping length 7.5m with zero level difference.
- Fan motor speed and air flow rate are from the highest speed to the lowest speed, total 7 rates for each model.
- Stable operation external static pressure range. (Note: setting external static pressure outside the unit's optimal static pressure range may lead to higher noise levels and lower airflow rate. For the optimal external static pressure range refer to the unit's installation manual.)
- Sound pressure level is from highest level to lowest level, total 7 levels for each model. Sound pressure level is measured 1.5m below the unit in an anechoic chamber.
- The dimension is only the body size, excluding the size of the installation lug, connecting copper pipe, etc. For detailed dimensions, please refer to the installation manual.
- All specifications are measured at standard external static pressure
- G1 air filter is standard for Medium Static Pressure Duct.

Table 1.2: MIH45(56,71,80)T2N18 specifications

Model			MIH45T2N18	MIH56T2N18	MIH71T2N18	MIH80T2N18
Power supply			1-phase, 220-240V, 50Hz			
Cooling <sup>1</sup>	Capacity	kW	4.5	5.6	7.1	8
		kBtu/h	15.4	19.1	24.2	27.3
	Power input	W	70	70	96	102
Heating <sup>2</sup>	Capacity	kW	5	6.3	8	9
		kBtu/h	17.1	21.5	27.3	30.7
	Power input	W	70	70	96	102
Fan motor type			DC			
Indoor coil	Number of rows		3	2	3	2
	Tube pitch	mm	18×10.72			
	Fin spacing and type	mm	1.35 Hydrophilic aluminum			
	Tube OD and type	mm	Φ5 Inner-groove			
	Dimensions (L×H×W)	mm	400×32.16×360	600×21.44×360	600×32.16×360	850×21.44×360
	Number of circuits		5	5	10	10
Air flow rate <sup>3</sup>		m <sup>3</sup> /h	665/623/580/538/4 95/453/410	970/904/838/773 /707/641/575	1150/1068/986/9 04/822/740/660	1355/1263/1172/1 080/988/897/805
External static pressure <sup>4</sup>		Pa	30 (10-160)			40 (10-160)
Sound pressure level <sup>5</sup>		dB(A)	33/32/29.5/28/26.5 /25/24	33/32/31/30/27.5 /26/25	35/33.5/32/30.5/ 29/27.5/26	37/35.5/34/32.5/31 /29.5/28
Sound power level		dB(A)	53/51/49/47/45/43 /41	55/53/51/49/47/4 5/43	58/56/54/51.5/48 /47/45	59/57/55/53/51/49 /47
Unit	Net dimensions <sup>6</sup> (W×H×D)		mm	600×245×750	800×245×750	1050×245×750
	Packed dimensions (W×H×D)		mm	765×305×885	965×305×885	1215×305×885
	Net/Gross weight		kg	19.5/22	24/27.5	25/28.5
Refrigerant type			R410A/R32			
Throttle type			Electronic expansion valve			
Design pressure (H/L)		MPa	4.4/2.6			
Pipe connections	Liquid/Gas pipe		mm	Φ6.35/Φ12.7		Φ9.52/Φ15.9
	Drain pipe		mm	OD Φ25		

Notes:

- Indoor temperature 27°C DB, 19°C WB; outdoor temperature 35°C DB; equivalent refrigerant piping length 7.5m with zero level difference.
- Indoor temperature 20°C DB; outdoor temperature 7°C DB, 6°C WB; equivalent refrigerant piping length 7.5m with zero level difference.
- Fan motor speed and air flow rate are from the highest speed to the lowest speed, total 7 rates for each model.
- Stable operation external static pressure range. (Note: setting external static pressure outside the unit's optimal static pressure range may lead to higher noise levels and lower airflow rate. For the optimal external static pressure range refer to the unit's installation manual.)
- Sound pressure level is from highest level to lowest level, total 7 levels for each model. Sound pressure level is measured 1.5m below the unit in an anechoic chamber.
- The dimension is only the body size, excluding the size of the installation lug, connecting copper pipe, etc. For detailed dimensions, please refer to the installation manual.
- All specifications are measured at standard external static pressure
- G1 air filter is standard for Medium Static Pressure Duct.

Table 1.3: MIH90(112,140,160)T2N18 specifications

Model			MIH90T2N18	MIH112T2N18	MIH125T2N18	MIH140T2N18	MIH160T2N18
Power supply			1-phase, 220-240V, 50Hz				
Cooling <sup>1</sup>	Capacity	kW	9	11.2	12.5	14	16
		kBtu/h	30.7	38.2	42.7	47.8	54.6
	Power input	W	110	138	172	172	210
Heating <sup>2</sup>	Capacity	kW	10	12.5	14	16	18
		kBtu/h	34.1	42.7	47.8	54.6	61.4
	Power input	W	110	138	172	172	210
Fan motor type			DC				
Indoor coil	Number of rows		3	2	3	3	3
	Tube pitch	mm	18×10.72				
	Fin spacing and type	mm	1.35 Hydrophilic aluminum				
	Tube OD and type	mm	Φ5 Inner-groove				
	Dimensions (L×H×W)	mm	850×32.16×360	1200×21.44×360	1200×32.16×360	1200×32.16×360	1200×32.16×360
	Number of circuits		10				
Air flow rate <sup>3</sup>		m <sup>3</sup> /h	1420/1323/1225 /1128/1030/933 /835	1950/1817/1683 /1550/1417/128 3/1150	2105/1971/1837 /1703/1568/143 4/1300	2105/1971/1837 /1703/1568/143 4/1300	2350/2160/2015 /1871/1776/153 3/1400
External static pressure <sup>4</sup>		Pa	40 (10-160)			50 (10-160)	
Sound pressure level <sup>5</sup>		dB(A)	37/35.5/34/32.5 /31/29.5/28	39/37/35/33/31/ 29/28	40/38/36/34/32/ 30/29	40/38/36/34/32/ 30/29	42/40/38/36/34/ 33/31
Sound power level		dB(A)	59/57/55/53/50. 5/48/46	60/58/56.5/55/5 3.5/52/50	64/62/61.5/59.5 /57.5/55/53	64/62/61.5/59.5 /57.5/55/53	65/63/61/58.5/5 6.5/54/52
Unit	Net dimensions <sup>6</sup> (W×H×D)	mm	1050×245×750	1400×245×750			
	Packed dimensions (W×H×D)	mm	1215×305×885	1565×305×885			
	Net/Gross weight	kg	31/35.0	37/42.0	39/44.0	39/44.0	39/44.0
Refrigerant type			R410A/R32				
Throttle type			Electronic expansion valve				
Design pressure (H/L)		MPa	4.4/2.6				
Pipe connections	Liquid/Gas pipe	mm	Φ9.52/Φ15.9				
	Drain pipe	mm	OD Φ25				

Notes:

- Indoor temperature 27°C DB, 19°C WB; outdoor temperature 35°C DB; equivalent refrigerant piping length 7.5m with zero level difference
- Indoor temperature 20°C DB; outdoor temperature 7°C DB, 6°C WB; equivalent refrigerant piping length 7.5m with zero level difference.
- Fan motor speed and air flow rate are from the highest speed to the lowest speed, total 7 rates for each model.
- Stable operation external static pressure range. (Note: setting external static pressure outside the unit's optimal static pressure range may lead to higher noise levels and lower airflow rate. For the optimal external static pressure range refer to the unit's installation manual.)
- Sound pressure level is from highest level to lowest level, total 7 levels for each model. Sound pressure level is measured 1.5m below the unit in an anechoic chamber.
- The dimension is only the body size, excluding the size of the installation lug, connecting copper pipe, etc. For detailed dimensions, please refer to the installation manual.
- All specifications are measured at standard external static pressure
- G1 air filter is standard for Medium Static Pressure Duct.

## 2 Dimensions

### 2.1 Unit Dimensions

Figure 2.1: External dimension, air outlet size, and size of fresh air outlet (unit: mm)

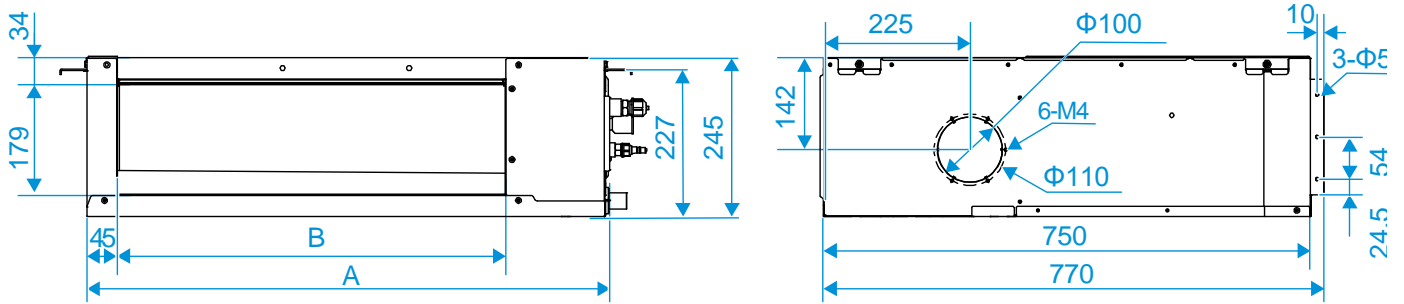

Figure 2.2: Size of return air inlet (rear return air mode): (unit: mm)

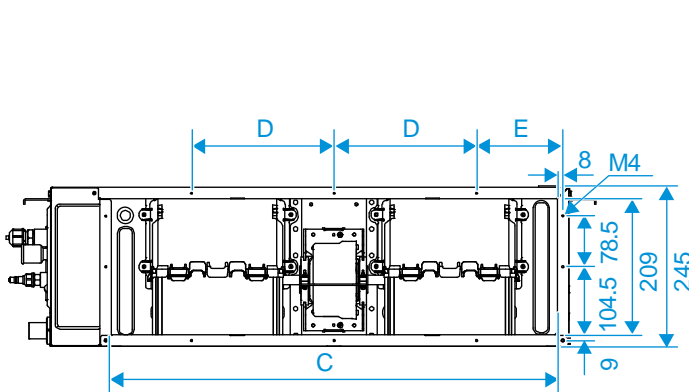

Figure 2.3: Piping and water pipe size:(unit: mm)

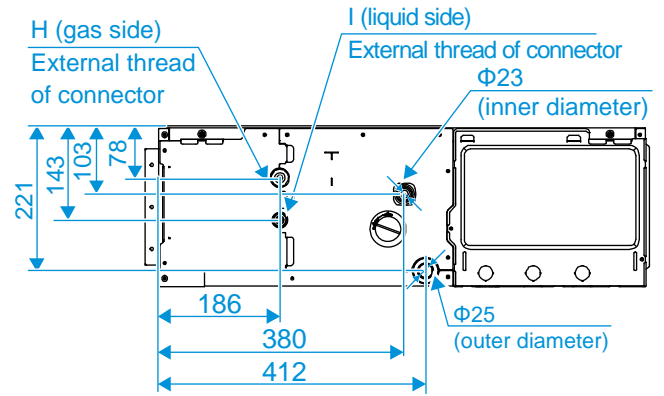
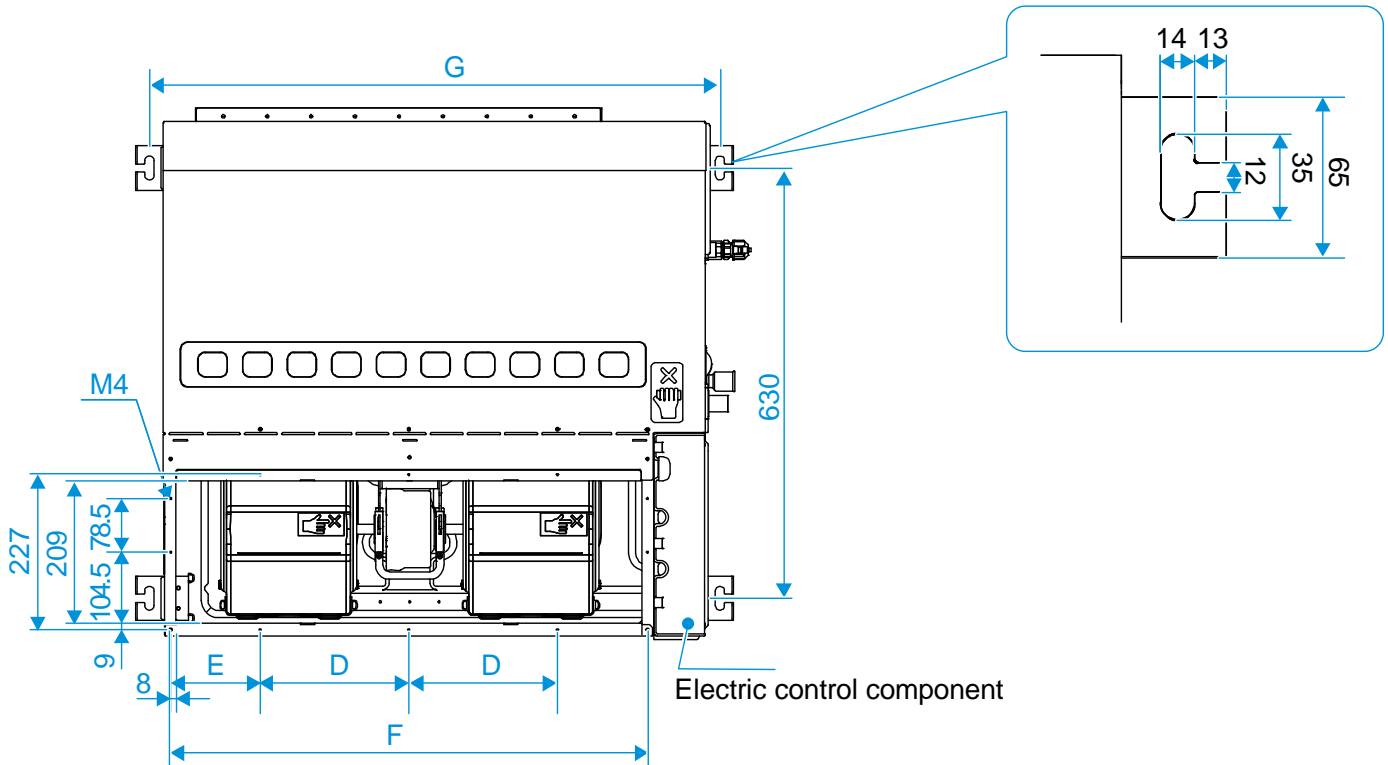

Figure 2.4: Size of return air inlet (bottom return air mode) and distance between lifting lugs:(unit: mm)



Notes: meaning of letters refer to Table 2.1



## V8 VRF Indoor Units



Table 2.1: Letter-Size Correspondence Table: (unit: mm)

Capacity (kW)	A	B	C	D	E	F	G	H	I
$kW \leq 4.5$	600	400	490	87.5	165	506	645	3/4-16 UNF	7/16-20 UNF
$4.5 < kW \leq 5.6$	800	600	690	220	134	706	845		
$5.6 < kW \leq 7.1$	800	600	690	220	134	706	845	7/8-14 UNF	5/8-18 UNF
$7.1 < kW < 11.2$	1050	850	940	220	146	956	1095		
$11.2 \leq kW \leq 16.0$	1400	1200	1290	220	213	1306	1445		

### 3 Unit Placement

#### 3.1 Placement Considerations

Unit placement should take account of the following considerations:

- Units should not be installed in the following locations:
  - A place filled with mineral oil, fumes or mist, like a kitchen.
  - A place where there are corrosive gases, such as acid or alkaline gases..
  - A place exposed to combustible gases and using volatile combustible gases such as diluent or gasoline.
  - A place where there is equipment emitting electromagnetic radiation.
  - A place where there is a high salt content in the air like a coast.
  - Do not use the air conditioner in an environment where an explosion may occur.
  - Places like in vehicles or cabin rooms.
  - Factories with major voltage fluctuations in the power supplies.
  - Other special environmental conditions.
- Units should be installed in positions where:
  - Ensure that the airflow in and out of the IDU is reasonably organized to form an air circulation in the room.
  - Ensure IDU maintenance space.
  - The nearer the drainage pipe and copper pipe are to the ODU, the lower the pipe cost is.
  - Prevent the air conditioner from blowing directly to the human body.
  - The closer the wiring to the power cabinet, the lower the wiring cost is.
  - Keep the air-conditioning return air away from the setting sun of the room.
  - Be careful not to interfere with the light tank, fire pipe, gas pipe and other facilities.
  - The IDU should not be lifted in the places like load-bearing beam and columns that affect the structural safety of the house.
  - The wired controller and the IDU should be in the same installation space; otherwise, the sampling point setting of the wired controller need to be changed.

#### 3.2 Space Requirements

Figure 3.1: Medium Static Pressure Duct space requirements (unit: mm)

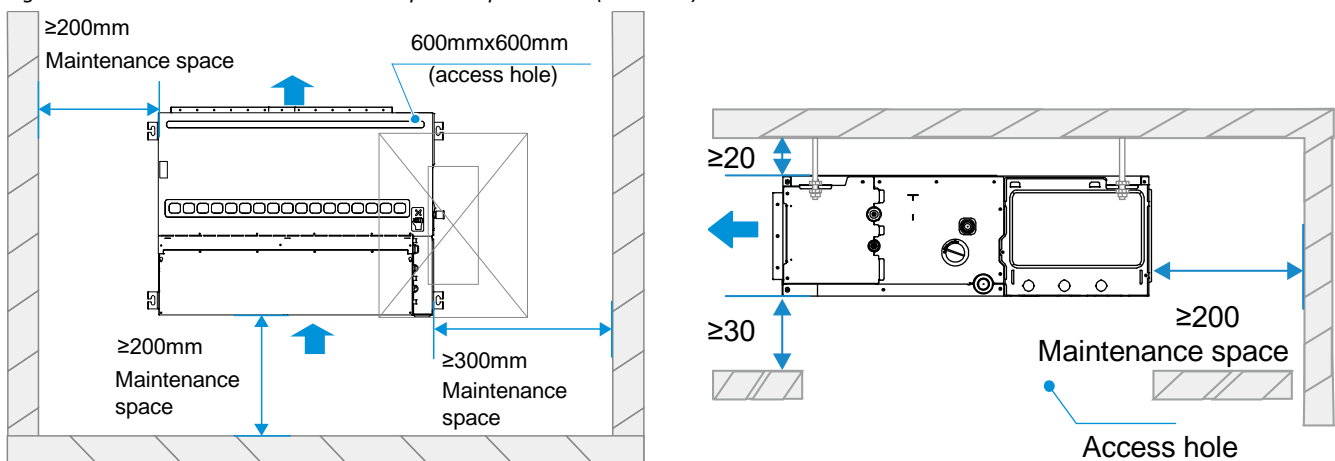

Notes:

1. The centerline of the maintenance hole should be in the same position as the centerline of the indoor unit.

## 4 Piping Diagram

Figure 4.1: Medium Static Pressure Duct piping diagram

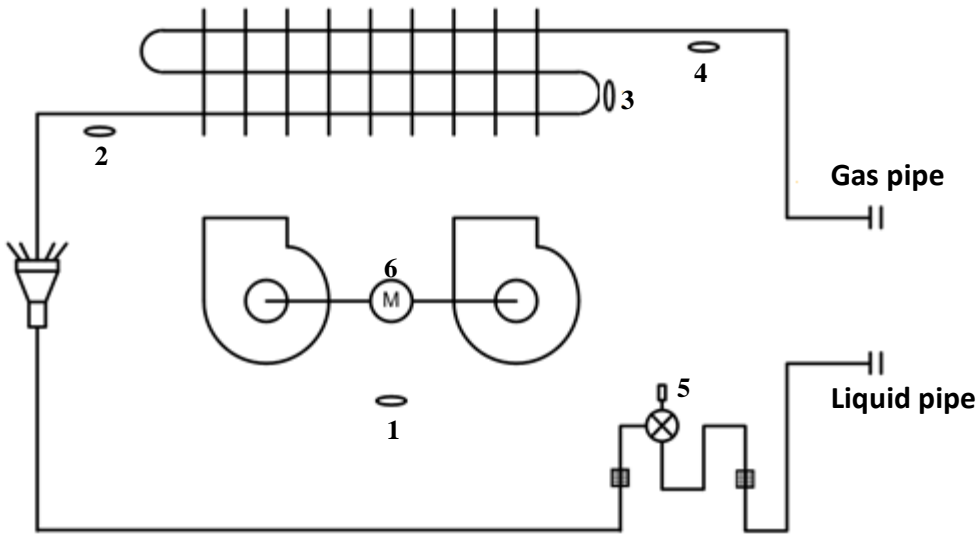

Legend	Code	Description
1	T1	Inlet Air Temp. Sensor
2	T2A	Liquid Pipe Temp. Sensor
3	T2	Middle Pipe Temp. Sensor
4	T2B	Gas Pipe Temp. Sensor
5	EEV	Electronic Expansion Valve
6	FAN	DC Fan motor

## 5 Wiring Diagram

Figure 5.1: Medium Static Pressure Duct wiring diagram

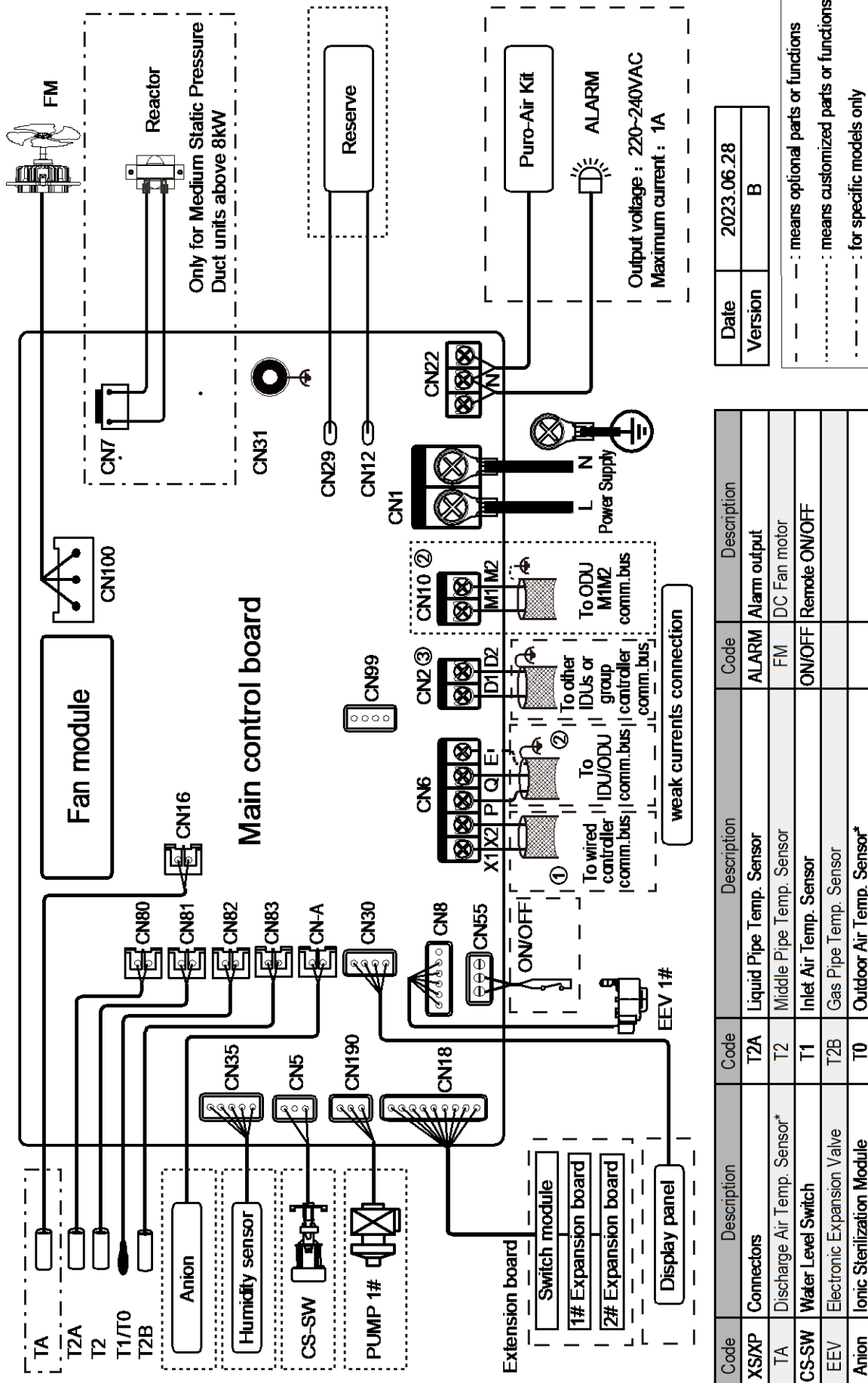

\* Indicates that this sensor is only available for Fresh Air Processing Unit

### Notes for installers and service engineers

#### Caution

- All installation, servicing and maintenance must be carried out by competent and suitably qualified, certified and accredited professionals and in accordance with all applicable legislation.
- Units should be grounded in accordance with all applicable legislation. Metal and other conductive components should be insulated in accordance with all applicable legislation.
- Power supply wiring should be securely fastened at the power supply terminals – loose power supply wiring would represent a fire risk.
- After installation, servicing or maintenance, the electric control box cover should be closed. Failing to close the electric control box cover risks fire or electric shock.
- The dotted lines indicate the field wiring or optional function.
- PQ and M1M2 communication ports both are used for indoor and outdoor communication, and only one of them can be used at a time. Meanwhile, be sure to connect the same communication ports (PQ to PQ; M1M2 to M1M2) in case of damage of the main control board.
- D1D2 communication ports are used for group control communication. When connecting the group controller, the D1D2 port of the indoor units that are to be group controlled must be connected in daisy chain, and the group controller must be connected to the X1X2 port of one of the indoor units in the group control, and set to group control mode. In addition, D1D2 communication ports can also be connected to the central controller.

## 6 Capacity Tables

### 6.1 Cooling Capacity Table

Table 6.1: Medium Static Pressure Duct cooling capacity

Model	Indoor air temperature (°C WB/DB)													
	14/20		16/23		18/26		19/27		20/28		22/30		24/32	
	TC	SC	TC	SC	TC	SC	TC	SC	TC	SC	TC	SC	TC	SC
MIH15T2N18	1.4	1.3	1.5	1.4	1.5	1.3	1.5	1.3	1.6	1.3	1.6	1.2	1.6	1.1
MIH22T2N18	2.0	1.9	2.1	1.9	2.2	1.9	2.2	1.8	2.3	1.8	2.3	1.7	2.4	1.7
MIH28T2N18	2.5	2.3	2.7	2.4	2.8	2.4	2.8	2.3	2.9	2.3	2.9	2.2	3.0	2.1
MIH36T2N18	3.2	3.0	3.4	3.1	3.6	3.1	3.6	3.0	3.7	3.0	3.8	2.8	3.9	2.7
MIH45T2N18	4.0	3.7	4.3	3.8	4.5	3.9	4.5	3.7	4.6	3.6	4.7	3.5	4.8	3.3
MIH56T2N18	5.0	4.6	5.3	4.7	5.6	4.8	5.6	4.6	5.7	4.5	5.8	4.3	6.0	4.1
MIH71T2N18	6.3	5.8	6.7	5.9	7.0	6.0	7.1	5.8	7.2	5.7	7.4	5.4	7.6	5.2
MIH80T2N18	7.1	6.3	7.6	6.5	7.9	6.6	8.0	6.5	8.1	6.3	8.3	6.0	8.5	5.8
MIH90T2N18	8.0	7.1	8.5	7.3	8.9	7.4	9.0	7.3	9.1	7.1	9.4	6.8	9.6	6.5
MIH112T2N18	9.9	8.8	10.6	9.1	11.1	9.3	11.2	9.1	11.3	8.8	11.6	8.4	11.9	8.1
MIH125T2N18	11.1	9.9	11.8	10.2	12.4	10.4	12.5	10.1	12.7	9.9	13.0	9.4	13.3	9.0
MIH140T2N18	12.4	11.1	13.2	11.4	13.8	11.5	14.0	11.3	14.2	11.0	14.5	10.5	14.9	10.1
MIH160T2N18	14.2	12.7	15.1	13.0	15.8	13.2	16.0	12.9	16.2	12.6	16.6	12.0	17.0	11.5

Abbreviations:

TC: Total capacity (kW)

SC: Sensible capacity(kW)

Notes:

1. Shaded cells indicate rating condition.

### 6.2 Heating Capacity Table

Table 6.2: Medium Static Pressure Duct heating capacity

Model	Indoor air temperature (°C DB)					
	16	18	20	21	22	24
	SHC	SHC	SHC	SHC	SHC	SHC
MIH15T2N18	1.9	1.9	1.8	1.7	1.7	1.6
MIH22T2N18	2.7	2.7	2.5	2.4	2.4	2.2
MIH28T2N18	3.4	3.4	3.2	3.1	3.0	2.8
MIH36T2N18	4.2	4.2	4.0	3.8	3.8	3.5
MIH45T2N18	5.3	5.3	5.0	4.8	4.7	4.4
MIH56T2N18	6.7	6.6	6.3	6.1	5.9	5.5
MIH71T2N18	8.5	8.4	8.0	7.8	7.5	7.0
MIH80T2N18	9.5	9.5	9.0	8.7	8.5	7.8
MIH90T2N18	10.6	10.5	10.0	9.7	9.4	8.8
MIH112T2N18	13.3	13.1	12.5	12.1	11.8	10.9
MIH125T2N18	14.8	14.7	14.0	13.6	13.2	12.2
MIH140T2N18	17.0	16.8	16.0	15.5	15.0	13.9
MIH160T2N18	19.1	18.9	18.0	17.5	16.9	15.7

Abbreviations:

SHC: Sensible Heat Capacity

Notes:

1. Shaded cells indicate rating condition.

## 7 Electrical Characteristics

Table 7.1: Medium Static Pressure Duct electrical characteristics

Model name	Power supply						Indoor Fan Motor	
	Hz	Volts	Min. volts	Max. volts	MCA	MFA	Rated power output (W)	FLA
MIH15T2N18	50	220-240	198	264	0.63	15	50	0.50
MIH22T2N18	50	220-240	198	264	0.63	15	50	0.50
MIH28T2N18	50	220-240	198	264	0.63	15	50	0.50
MIH36T2N18	50	220-240	198	264	0.80	15	50	0.64
MIH45T2N18	50	220-240	198	264	1.19	15	50	0.95
MIH56T2N18	50	220-240	198	264	1.19	15	60	0.95
MIH71T2N18	50	220-240	198	264	1.50	15	60	1.2
MIH80T2N18	50	220-240	198	264	1.50	15	240	1.2
MIH90T2N18	50	220-240	198	264	1.63	15	240	1.3
MIH112T2N18	50	220-240	198	264	2.29	15	240	1.8
MIH125T2N18	50	220-240	198	264	2.31	15	240	1.9
MIH140T2N18	50	220-240	198	264	2.31	15	240	1.9
MIH160T2N18	50	220-240	198	264	2.76	15	240	2.2

Abbreviations:

MCA: Minimum Circuit Amps

MFA: Maximum Fuse Amps

FLA: Full Load Amps

## 8 Sound Levels

### 8.1 Overall

Table 8.1: Medium Static Pressure Duct sound pressure levels<sup>1</sup>

Model name	Sound pressure levels dB						
	SSH	SH	H	M	L	SL	SSL
MIH15T2N18	26.5	26	25	24	23	22.5	22
MIH22T2N18	26.5	26	25	24	23	22.5	22
MIH28T2N18	26.5	26	25	24	23	22.5	22
MIH36T2N18	29	28	27	26	25	23	22
MIH45T2N18	33	32	29.5	28	26.5	25	24
MIH56T2N18	33	32	31	30	27.5	26	25
MIH71T2N18	35	33.5	32	30.5	29	27.5	26
MIH80T2N18	37	35.5	34	32.5	31	29.5	28
MIH90T2N18	37	35.5	34	32.5	31	29.5	28
MIH112T2N18	39	37	35	33	31	29	28
MIH125T2N18	40	38	36	34	32	30	29
MIH140T2N18	40	38	36	34	32	30	29
MIH160T2N18	42	40	38	36	34	33	31

Notes:

- The sound pressure level is measured in an anechoic chamber at a distance of 1.5m below the unit, under the default static pressure setting at the factory. During on-site operation, the sound pressure level may be higher due to the influence of environmental noise.

Figure 8.2: Medium Static Pressure Duct sound pressure level measurement

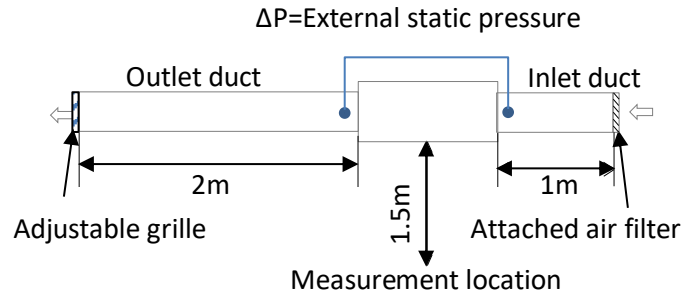

Connected to a top-discharge outdoor unit and measured in anechoic room. Adjusting the outlet grille to make the  $\Delta P$  is equal to the rated static pressure, the data was recorded at 1.5m below the unit.

### 8.2 Octave Band Levels

Figure 8.3: MIH15T2N18 octave band levels

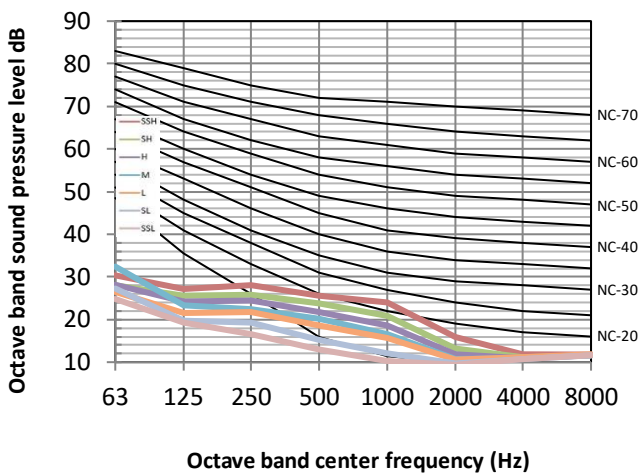

Figure 8.4: MIH22T2N18 octave band levels

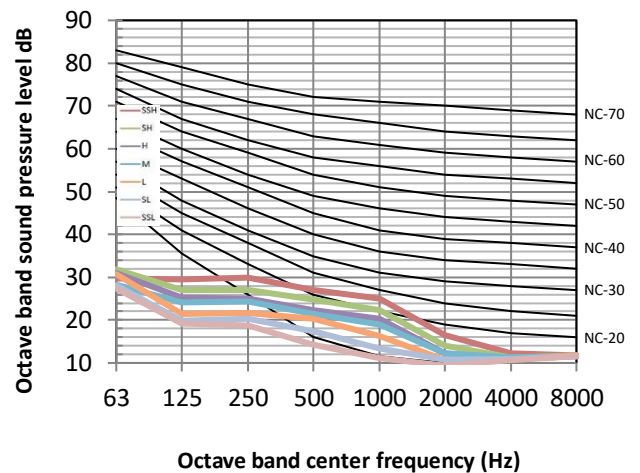



Figure 8.5: MIH28T2N18 octave band levels

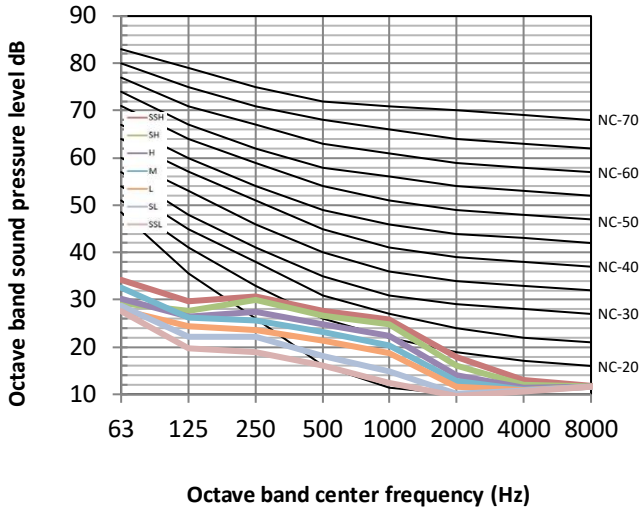

Figure 8.6: MIH36T2N18 octave band levels

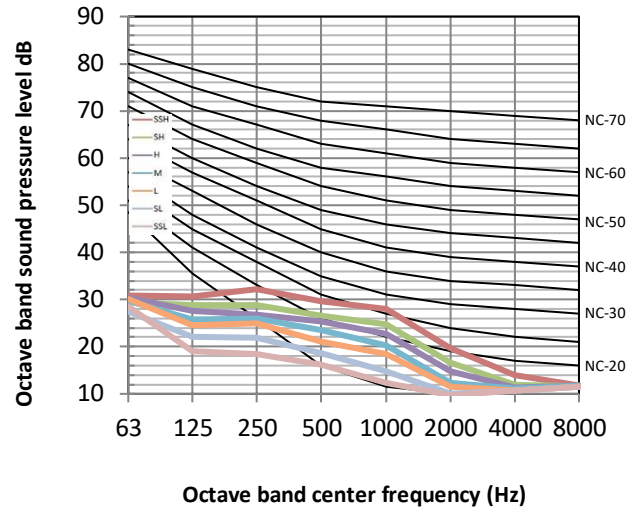

Figure 8.7: MIH45T2N18 octave band levels

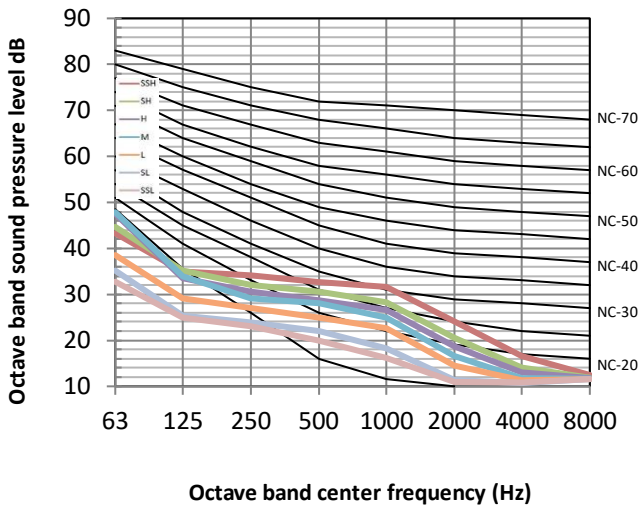

Figure 8.8: MIH56T2N18 octave band levels

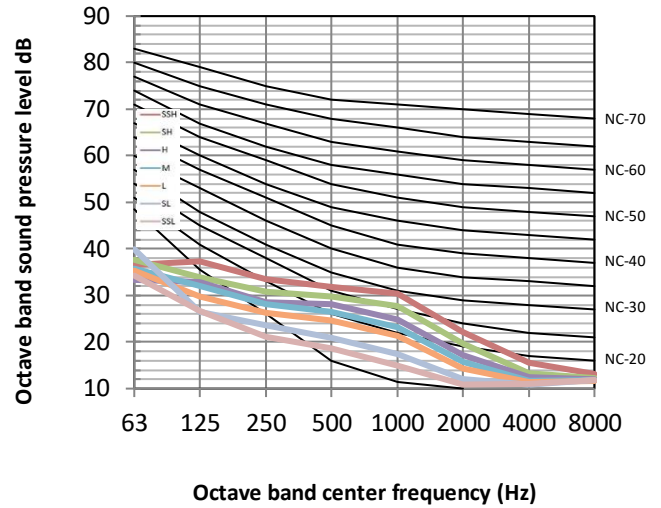

Figure 8.9: MIH71T2N18 octave band levels

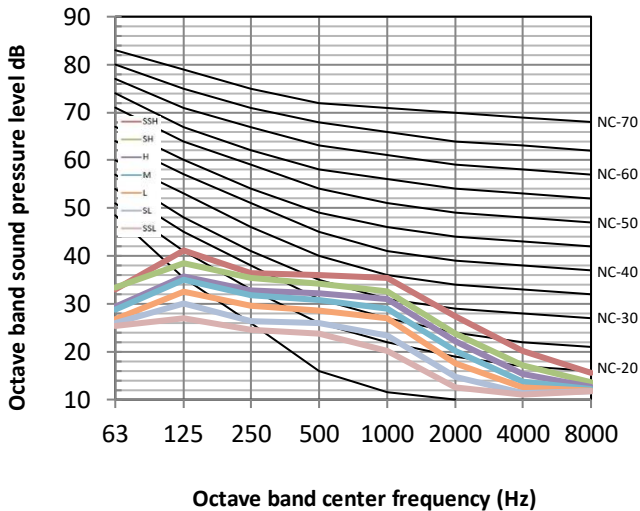

Figure 8.10: MIH80T2N18 octave band levels

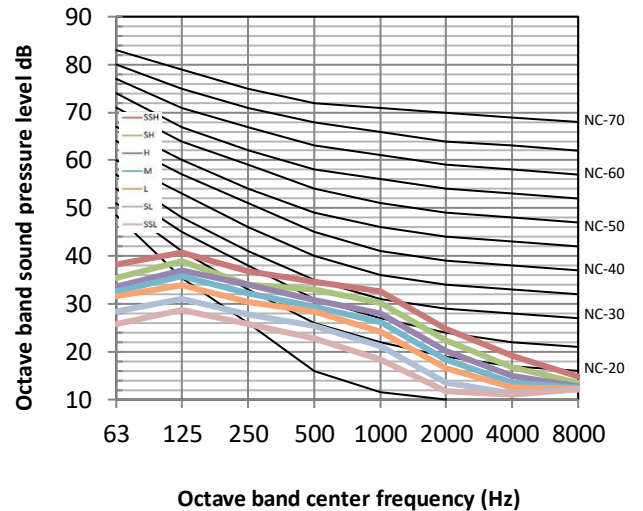

Figure 8.11: MIH90T2N18 octave band levels

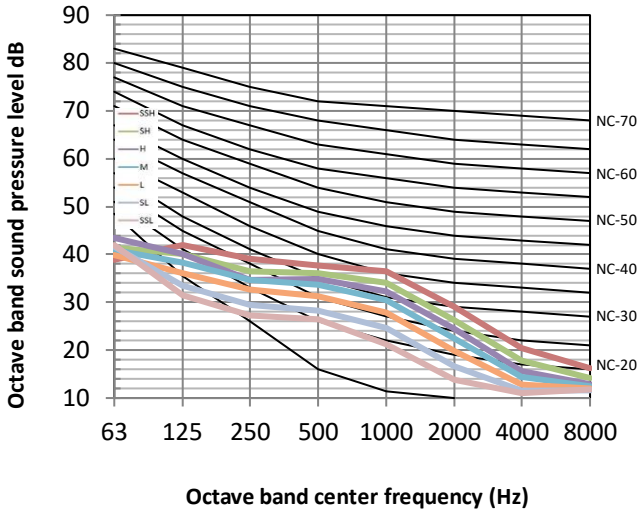

Figure 8.12: MIH112T2N18 octave band levels

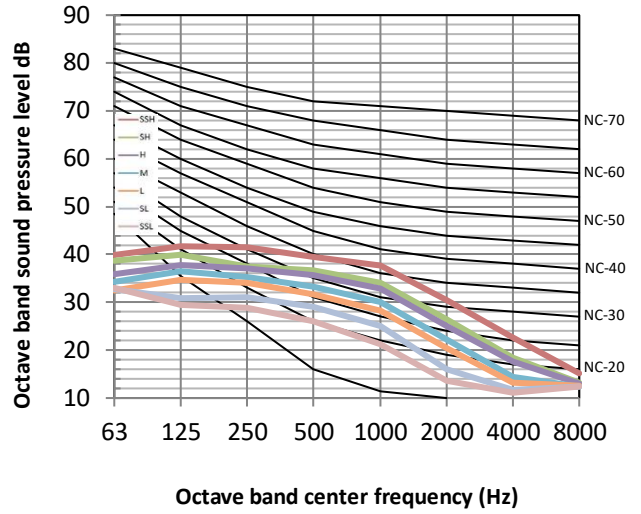

Figure 8.13: MIH125T2N18 octave band levels

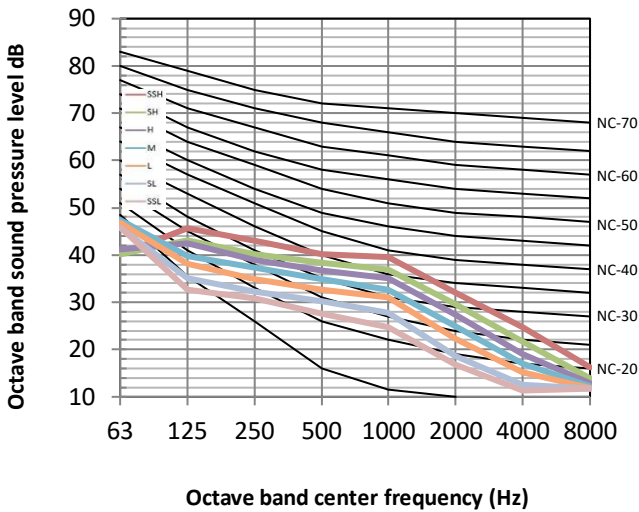

Figure 8.14: MIH140T2N18 octave band levels

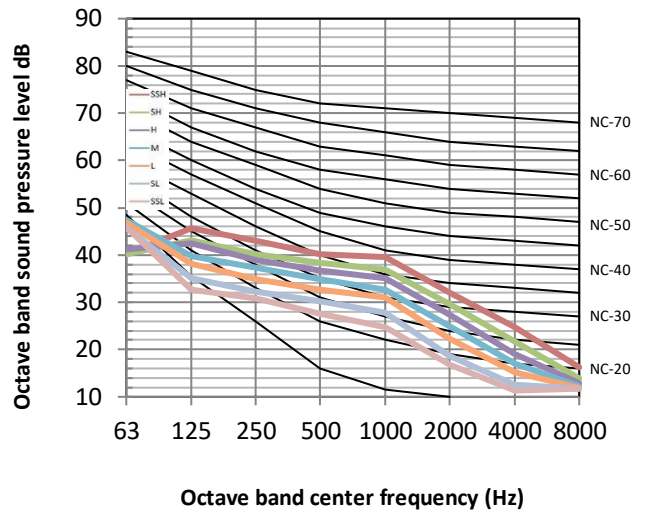
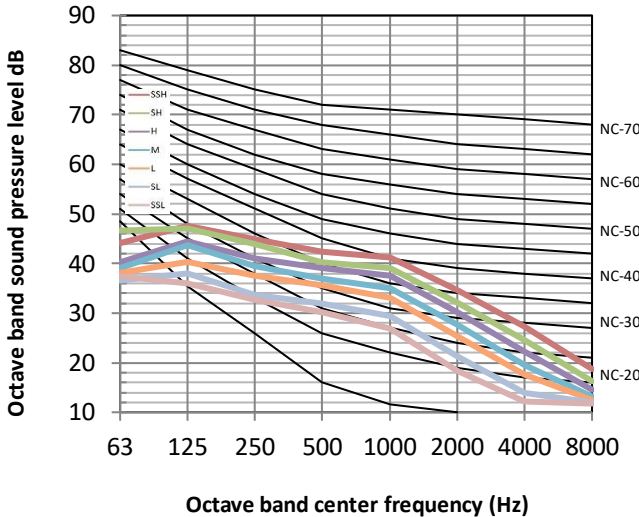

Figure 8.15: MIH160T2N18 octave band levels



## V8 VRF Indoor Units

### 9 Fan Performance

#### 9.1 How to switch between Constant Airflow mode and Constant Speed mode

- ① In the main interface, press "≡" + "↵" for 3 seconds at the same time, and the main interface will display "CC". Press the "▲" and "▼" to select the indoor unit ("n00-n63" is displayed, and the last two digits are the indoor unit addresses). Press the "↵" to enter the parameter setting interface, and "n00" will be displayed.
- ② Press the "▲" and "▼" until "N30" is displayed on the page, and then press the "↵" to enter the mode setting. Use the "▲" and "▼" keys to adjust to the demand mode parameter values, and press the "↵" to confirm.
- ③ Press the "⌚" button to return to the previous menu and exit the parameter setting. Parameter setting will also exit after 60 s of no operation

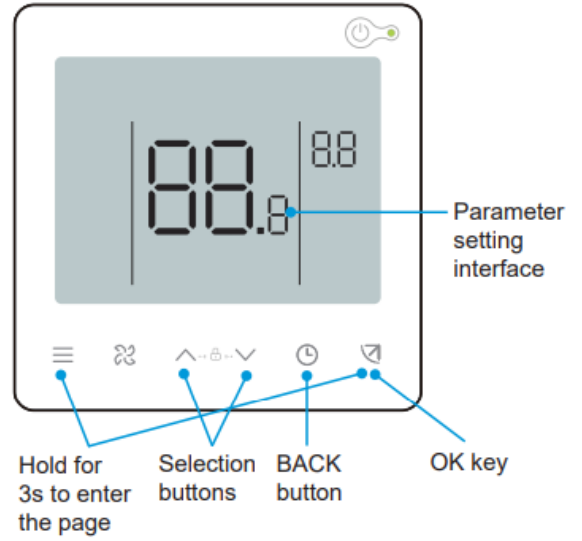

Table 9.1: Arc Duct mode setting

First level menu	Second level menu	Description	Default
n30	00	Constant Speed	-
	01	Constant Airflow	√

Notes:

1. The above is only an example. If you choose other controllers, please refer to their instructions for setting.

#### 9.2 Constant Airflow mode

##### 9.2.1 Fan performance diagram

Figure 9.1: MIH15T2N18

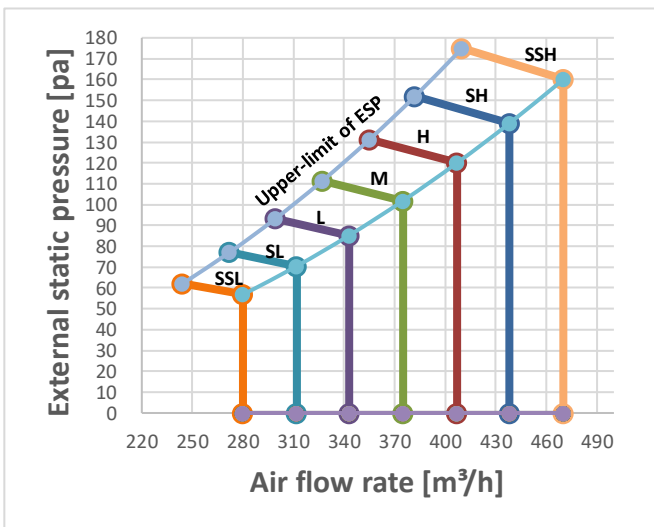

Figure 9.2: MIH22T2N18

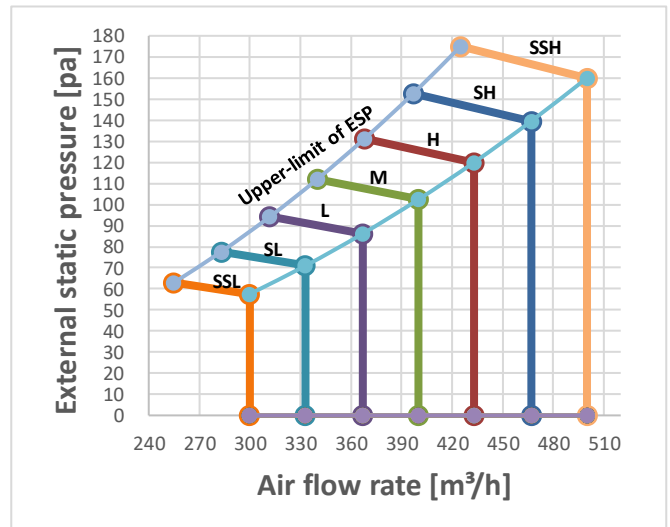

Figure 9.3: MIH28T2N18

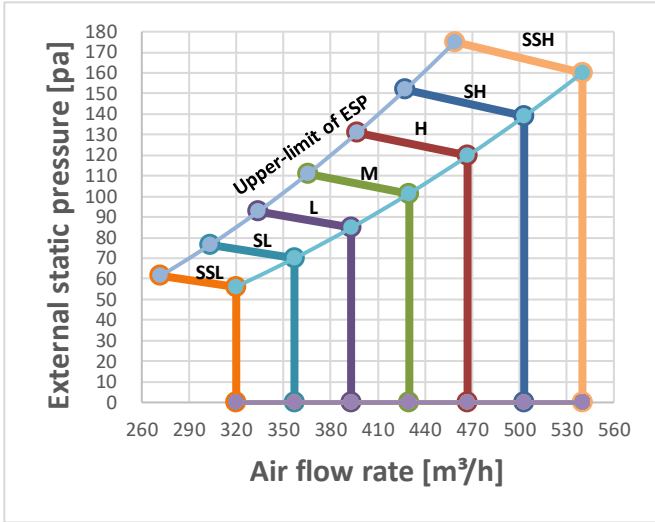

Figure 9.4: MIH36T2N18

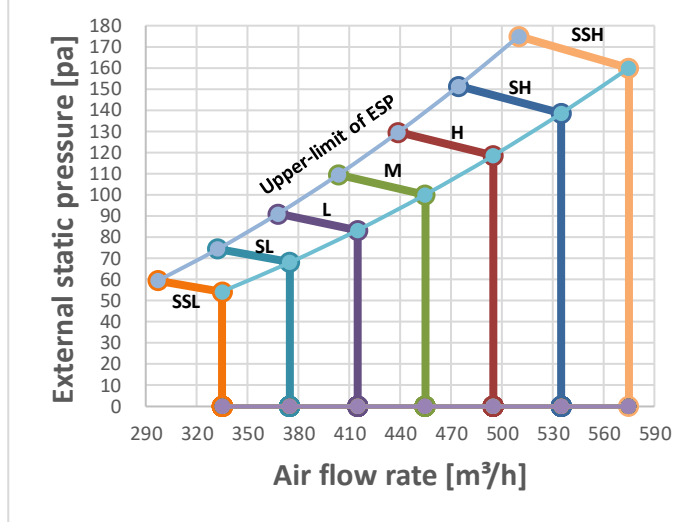

Figure 9.5: MIH45T2N18

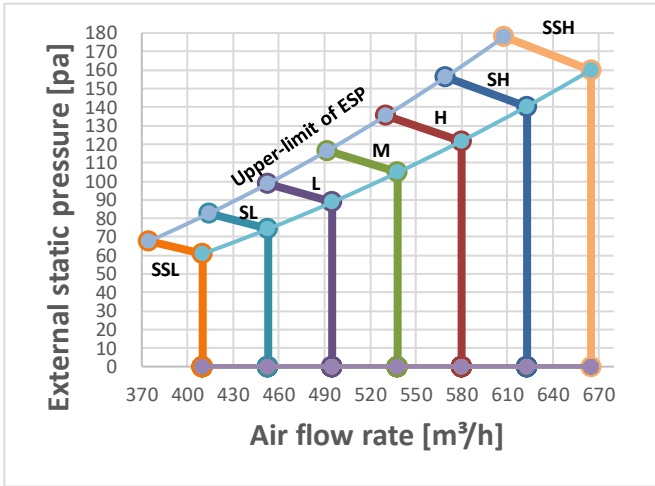

Figure 9.6: MIH56T2N18

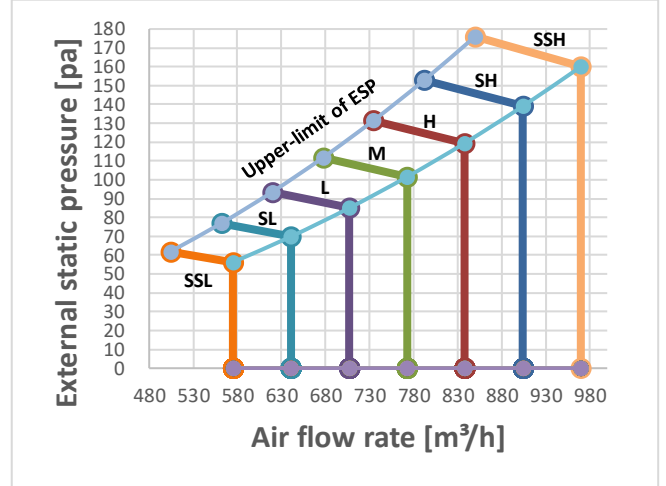

Figure 9.7: MIH71T2N18

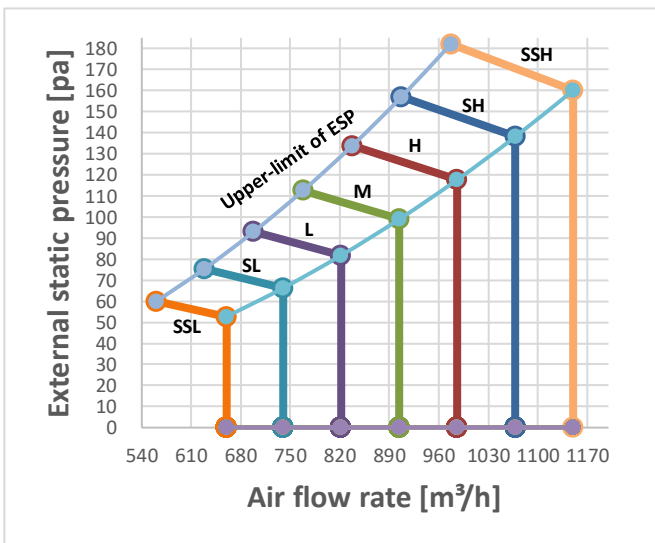
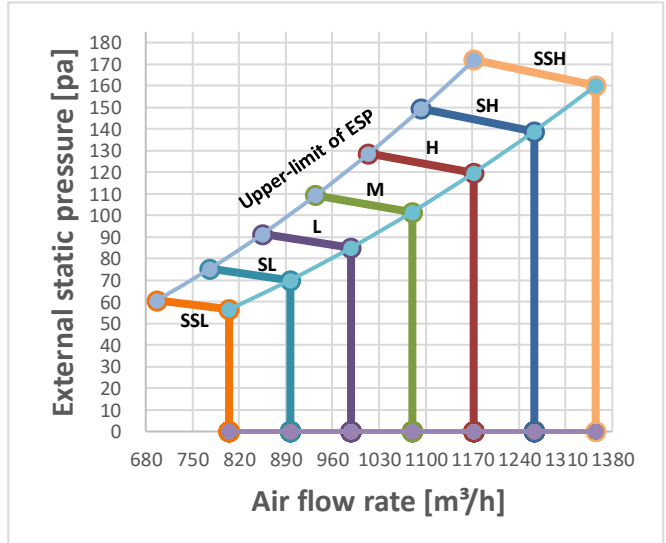

Figure 9.8: MIH80T2N18



## V8 VRF Indoor Units



Figure 9.9: MIH90T2N18

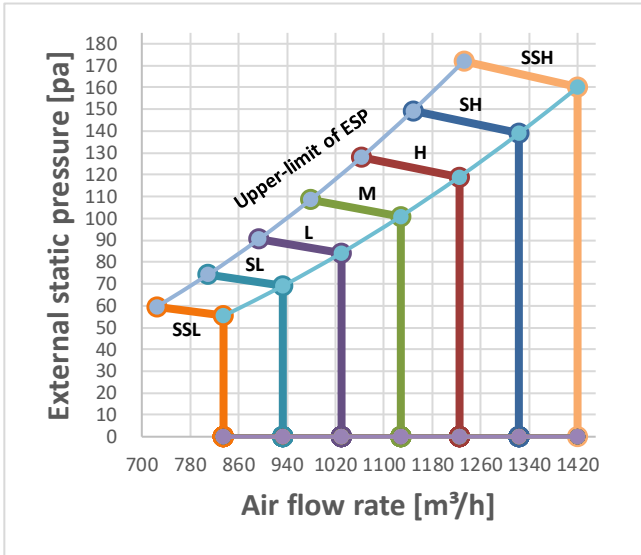

Figure 9.10: MIH112T2N18

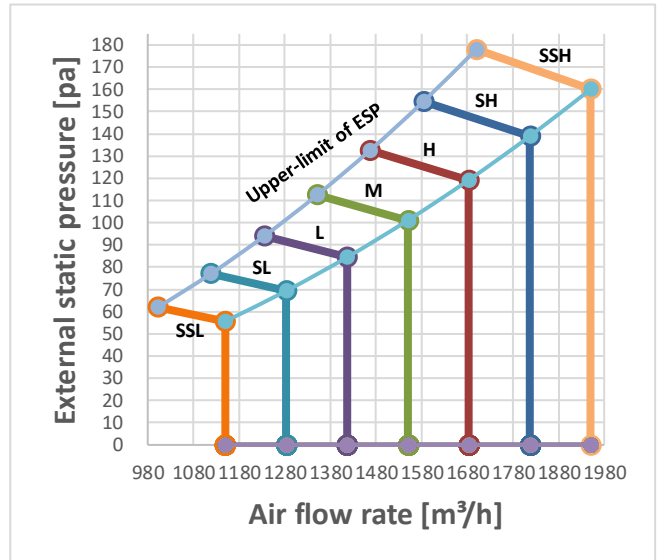

Figure 9.11: MIH125T2N18

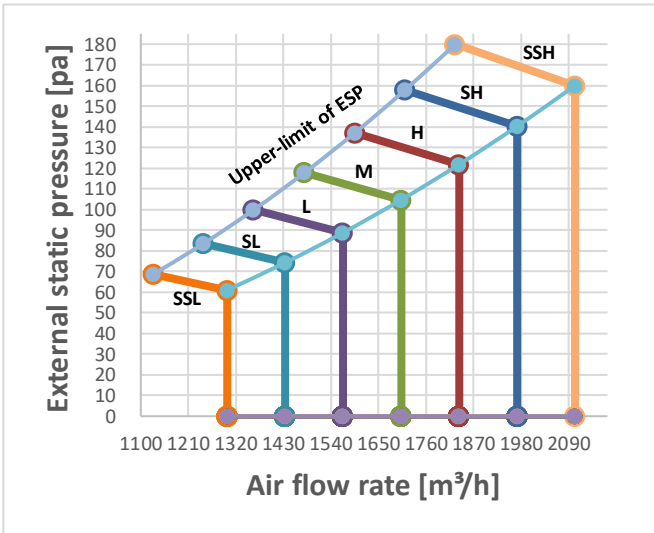

Figure 9.12: MIH140T2N18

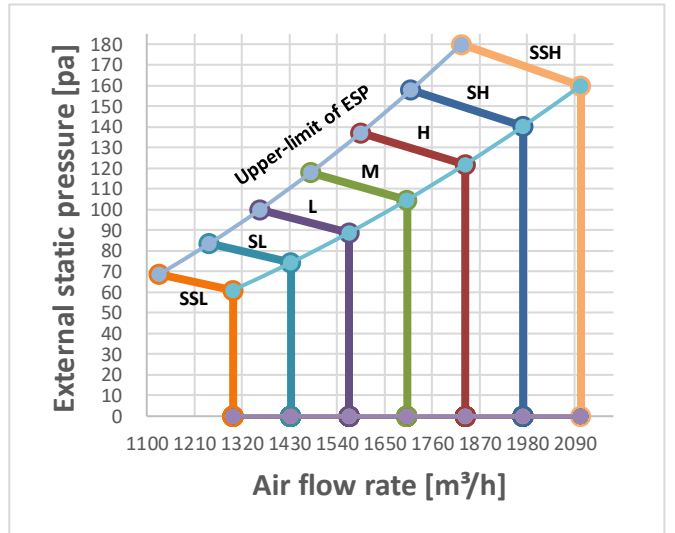
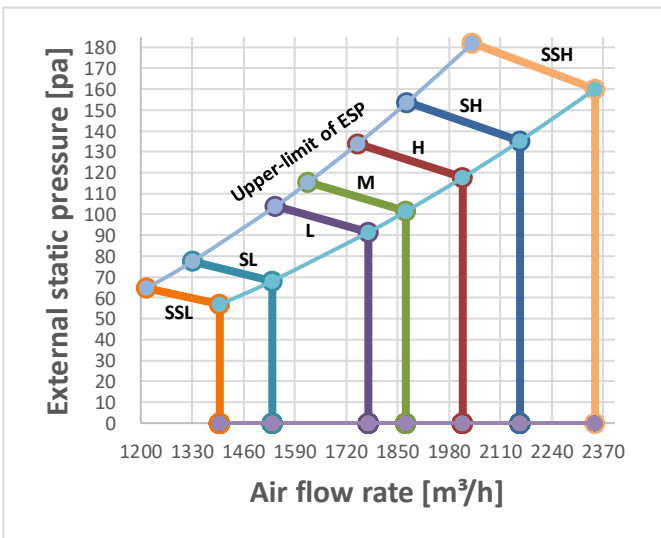

Figure 9.13: MIH160T2N18



## 9.2.2 How to Read the Diagram (Constant Airflow mode)

The vertical axis is the External Static Pressure (Pa) while the horizontal axis represents the Air Flow (m<sup>3</sup>/h). The characteristic curve for the "SSH","SH", "H", "M", "L","SL" and "SSL" fan speed control.

For MIH140T2N18, in "H" windshield, when the external static pressure is less than 122 Pa, the air flow keeps 1837 m<sup>3</sup>/h, but when the external static pressure is greater than 122 Pa, the air flow begins to decline, and the allowable maximum external static pressure is 137 Pa.

## 9.3 Constant Speed mode

### 9.3.1 Set external static pressure parameters

① In the main interface, press "☰" + "↵" for 3 seconds at the same time, and the main interface will display "CC". Press the "▲" and "▼" to select the indoor unit ("n00-n63" is displayed, and the last two digits are the indoor unit addresses). Press the "↵" to enter the parameter setting interface, and "n00" will be displayed.

② When "n00" is displayed, press the "↵" to enter the static pressure setting. Use the "▲" and "▼" keys to adjust to the demand parameter values, and press the "↵" to confirm.

③ Press the "⌚" button to return to the previous menu and exit the parameter setting. Parameter setting will also exit after 60 s of no operation

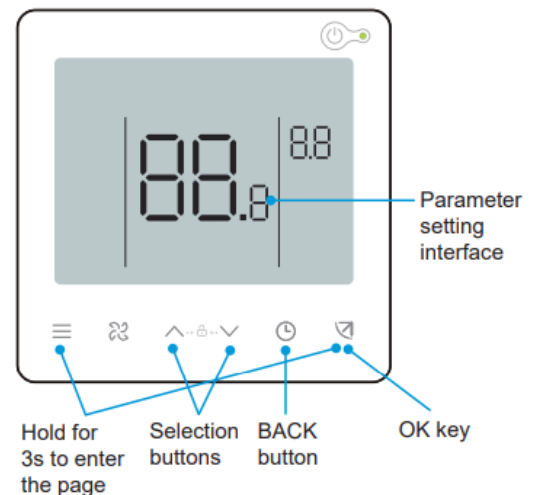

Table 9.1: External static pressure setting (1.5-7.1kW)

First level menu	Second level menu	Description	Default
N00	00/01/02/03/04/05/~ /19	Static pressure level	1.5-7.1kW: 06 8.0-11.2kW: 07 12.5-16.0kW: 08

Level	00	01	02	03	04	05	06	07	08	09	10
Static pressure(Pa)	0	5	10	15	20	25	30	40	50	60	70

Level	11	12	13	14	15	16	17	18	19
Static pressure(Pa)	80	90	100	110	120	130	140	150	160

Notes:

- The above is only an example of 86S wired controller. If you choose other controllers, please refer to their manuals for setting.



## 9.3.2 Fan performance diagram

Figure 9.14: MIH15T2N18

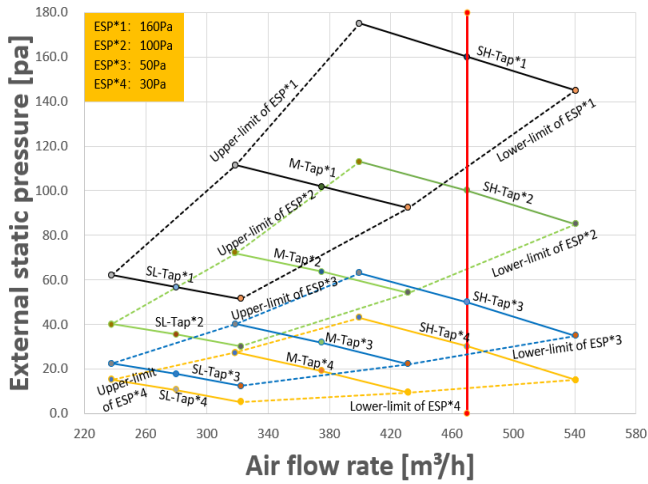

Figure 9.15: MIH22T2N18

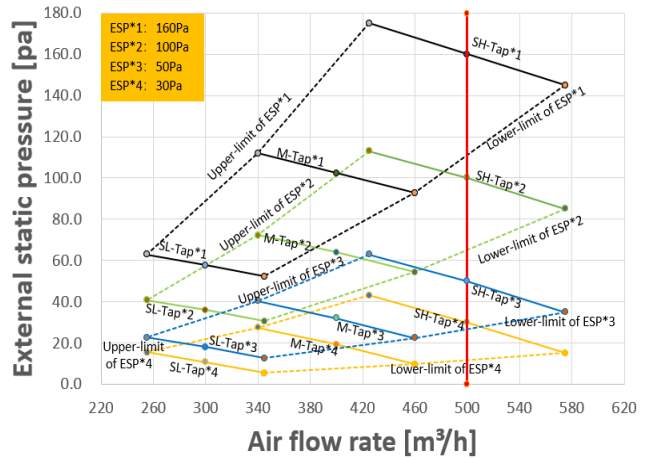

Figure 9.16: MIH28T2N18

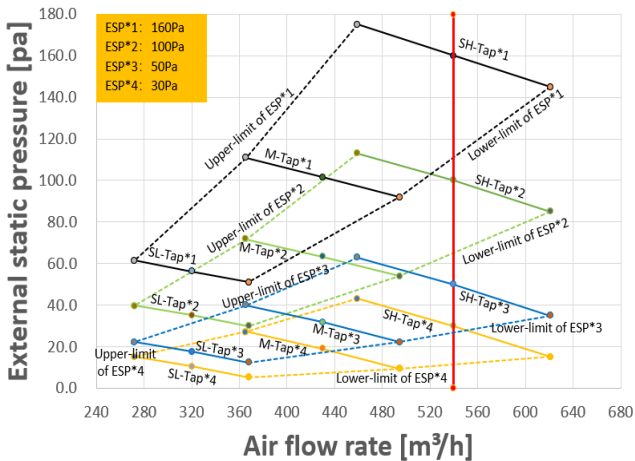

Figure 9.17: MIH36T2N18

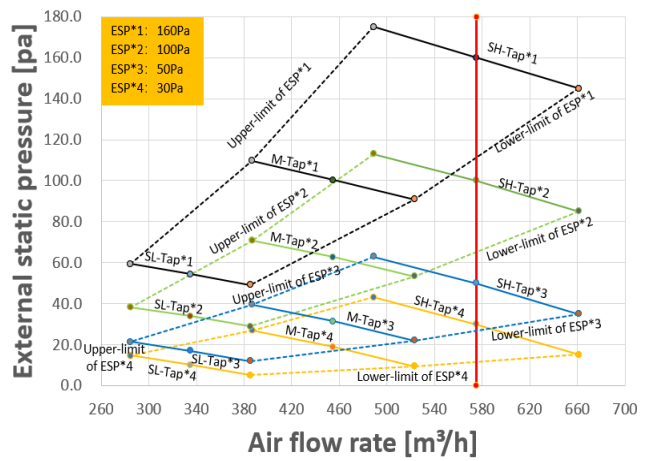

Figure 9.18: MIH45T2N18

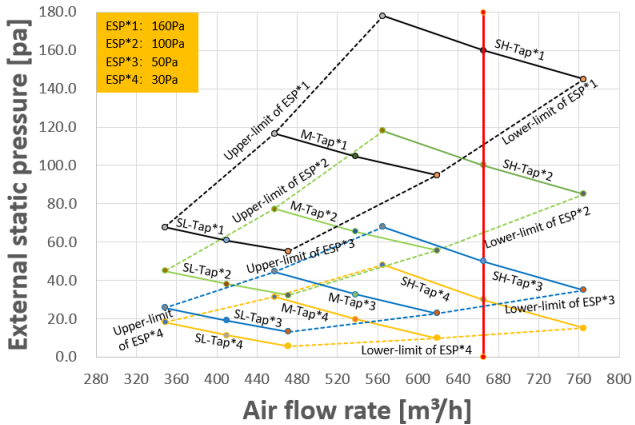

Figure 9.19: MIH56T2N18

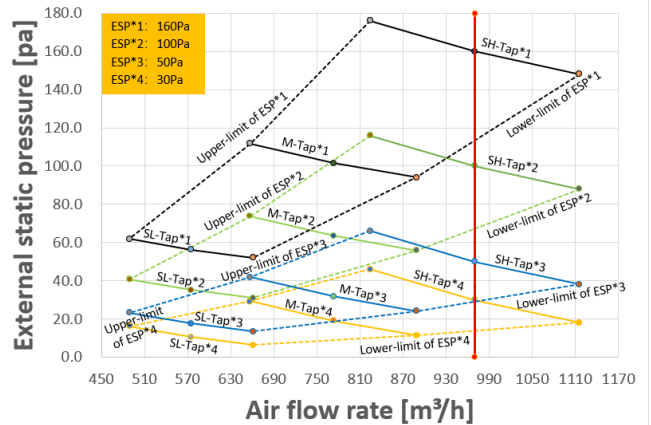

Figure 9.20: MIH71T2N18

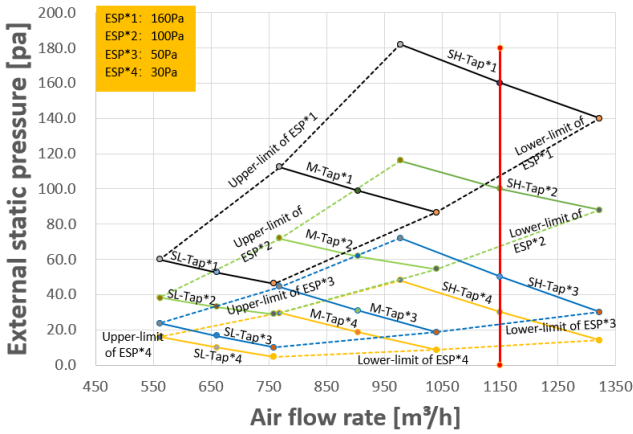

Figure 9.21: MIH80T2N18

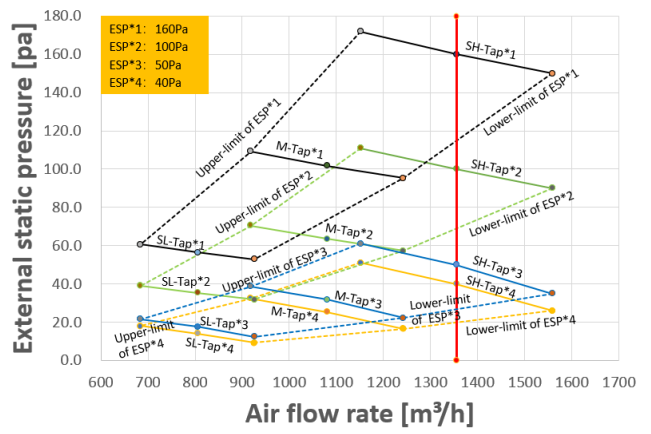

Figure 9.22: MIH90T2N18

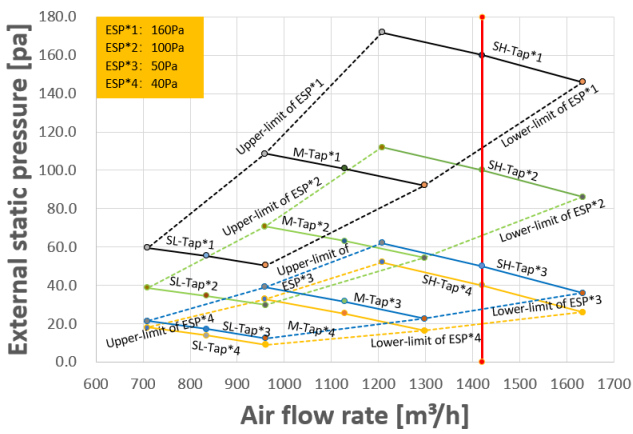

Figure 9.23: MIH112T2N18

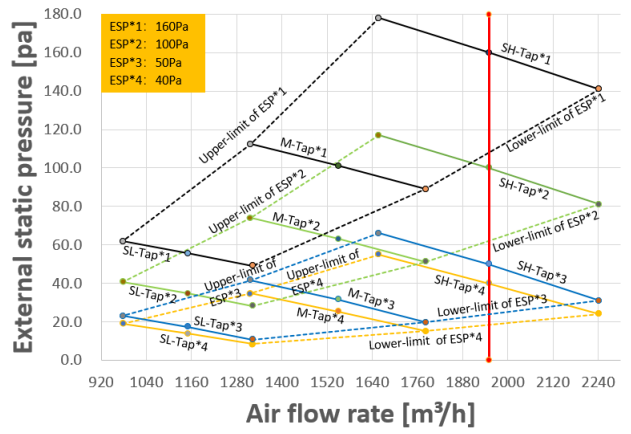

Figure 9.24: MIH125T2N18

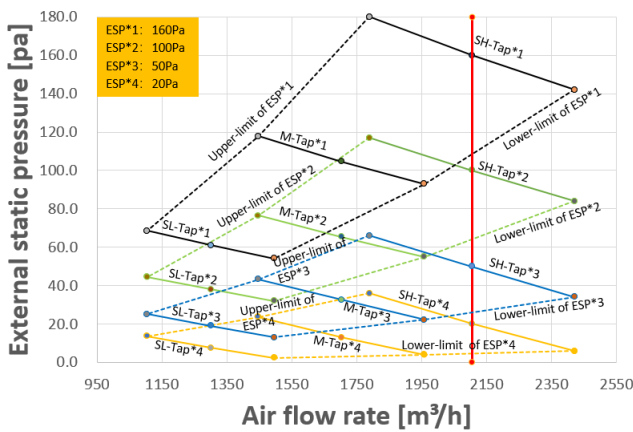

Figure 9.25: MIH140T2N18

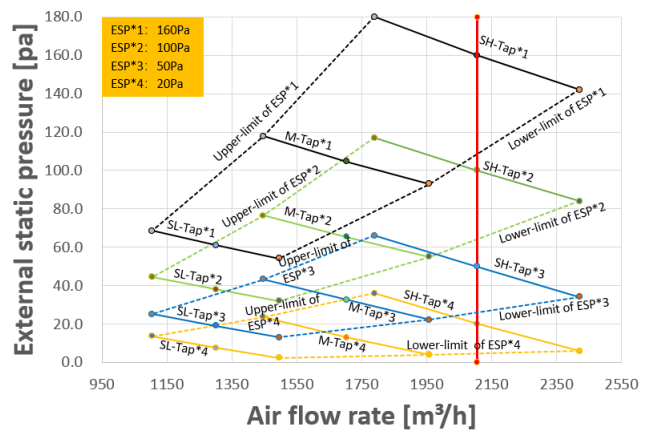
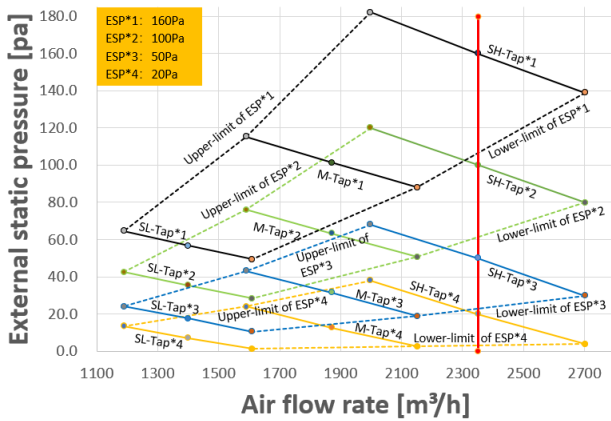



Figure 9.26: MIH160T2N18



### 9.3.3 How to Read the Diagram (Constant Speed mode)

The vertical axis is the External Static Pressure (Pa) while the horizontal axis represents the Air Flow (m³/h). The characteristic curve for the “SH”, “M” and “SL” fan speed control.

The Air Flow decreases with the increase of the external static pressure. For MIH140T2N18, in “SH” windshield and “50Pa” setting static pressure, when the external static pressure is 50Pa, the air flow is 2105 m³/h, and the allowable external static pressure range is 34 to 66.



T-V8T2HEU  
Ver. 2023-10

**Midea Building Technologies Division**  
**Midea Group**

**Add.:** Midea Headquarters Building, 6 Midea Avenue, Shunde, Foshan, Guangdong, China

**Postal code:** 528311

mbt.midea.com / [www.midea-group.com/](http://www.midea-group.com/) [tsp.midea.com/](http://tsp.midea.com/)

Note: Product specifications change from time to time as product improvements and developments are released and may vary from those in this document.

