

INSTALLATION & OWNER'S MANUAL

Wired Controller

MODEL:KJRP-86A/BMFNKD-E
KJRP-86I/MFK-E



Thank you very much for purchasing our product.

Before using your unit, please read this manual carefully and keep it for future reference.

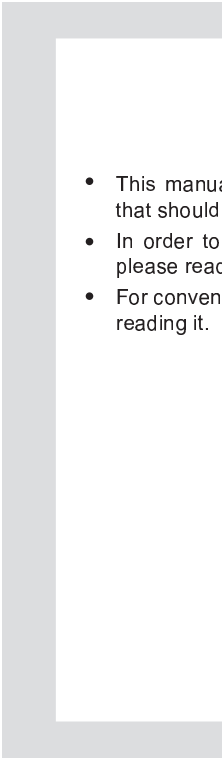
- 
- This manual gives detailed description of the precautions that should be brought to your attention during operation.
 - In order to ensure correct service of the wired controller please read this manual carefully before using the unit.
 - For convenience of future reference, keep this manual after reading it.

CONTENTS

- 1 Quick Operation Process 01
- 2 Features 01
- 3 Main Parameters 02
- 4 Overview 03
- 5 Basic Setting 04
- 6 Fan Speed Setting 05
- 7 Timer Setting 06
- 8 Child Lock Setting 07
- 9 Indoor Temperature Display 07
- 10 Project Commissioning 08
- 11 Installation 13

1 Quick Operation Process



1.1 Auxiliary function operation

- Timer function:

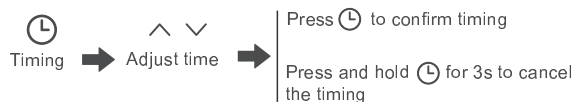

- ECO function:



2 Features



Modbus
(Not supported if non-networked)



Electric auxiliary heating mode
(Not supported if non-networked)



ECO setting



Timer function



Child lock

3 Main Parameters

Model	Networked: KJRP-86A/BMFNKD-E Non-networked: KJRP-86I/MFK-E
Rated voltage	220-240V~, 50/60Hz
Rated Current	Substantially resistive load: max. 1A /output, total: max. 1A Inductive load: max. 0.9A /output, total: max. 1A, PF=0.93
Temperature limit	-15°C to 43°C
Humidity	≤RH90 %
Degree of pollution	2
Action Type	1B.U





CAUTION

- Entrust a qualified local technician to perform installation. The user must not install the unit. The unit must be installed by a professional technician.
- Before cleaning or maintenance, ensure the power supply is cut off. Do not use water for washing to prevent electric shocks.
- Do not operate with wet hands to avoid electric shocks.
- Do not use pesticides, disinfectants, or flammable directly on the wired controller as they may damage the device or cause fires.
- Do not try to remove the display panel with your bare hands to avoid electric shocks.

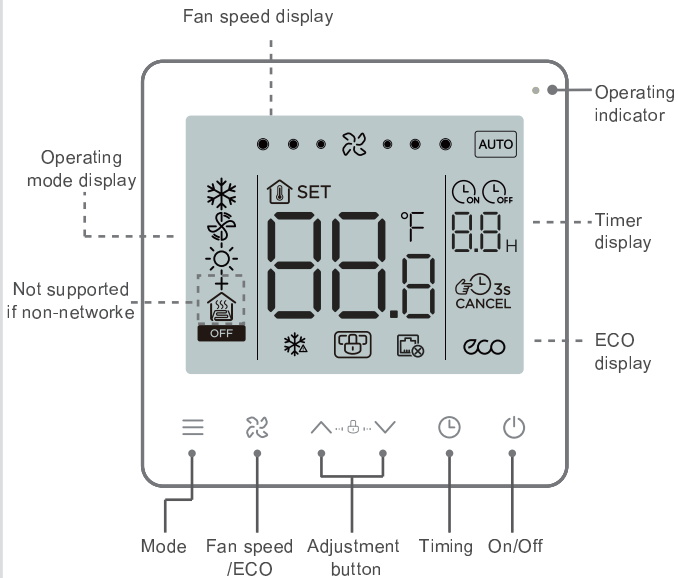
4 Overview



5 Basic Setting

- 1 On/Off Press  . The operating status LED turns on and the air conditioner starts operating;
Press  again. The operating status LED turns off and the air conditioner stops operating.



OFF

The icon is displayed when the air conditioner is off.

- 2 Mode selection Press  to change the operating mode according to the order shown below:



Two-pipe cooling and heating scenario is set before delivery from factory by default. The scenario can be changed based on the parameter settings according to the actual need.

Only two-pipe cooling and two-pipe cooling and heating modes are supported if non-networked.

Scenario	Mode switch
Two-pipe cooling	→ Cool → Fan →
Two-pipe cooling and heating	→ Cool → Fan → Heat →
Two-pipe cooling + Auxiliary electric heater	→ Cool → Fan → Auxiliary electric heater →
Two-pipe heating + Auxiliary electric heater	→ Cool → Fan → Auxiliary electric heater → Heat + Auxiliary electric heater →
Two-pipe cooling and heating + Auxiliary electric heater	→ Cool → Fan → Heat → Auxiliary electric heater → Heat + Auxiliary electric heater →
Four-pipe	→ Cool → Fan → Heat →

3 Temperature setting



Except in the Fan mode, press \wedge or \vee to adjust the set temperature indoors. Press and hold the button to increase or decrease the set temperature continuously.

4 ECO setting



Press and hold  bottom for 2s to enable ECO mode.
Cooling ECO: 26 $^{\circ}\text{C}$, low fan speed;
Fan ECO: low fan speed;
Heating ECO: 18 $^{\circ}\text{C}$, low fan speed;
Auxiliary electric heater ECO: 18 $^{\circ}\text{C}$, low fan speed;
Heating + Auxiliary electric heater ECO: 18 $^{\circ}\text{C}$, low fan speed

6 Fan Speed Setting

1 Adjust fan speed



Press  to adjust the fan speed, which can be set to High, Normal, Low and Auto.



CAUTION

- After the fan speed is set, it takes time for the air conditioner to respond. It is normal if the air conditioner does not respond to the setting immediately.

7 Timer Setting

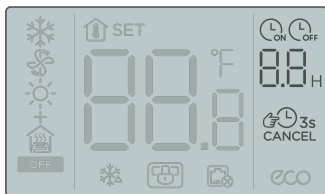

1 Timed On setting:



2 Timed Off setting:



3 Cancel timing:

Press and hold Timer for 3s or set the timer to 0.0 to cancel timing.

CAUTION

- Timed Off can be set when the air conditioner is on and Timed On can be set when the air conditioner is off.

8 Child Lock Setting

1 Enable child lock:



Press and hold the two buttons for 1.5s



Enable child lock

The wired controller doesn't respond when buttons are pressed and  flashes.

2 Disable child lock



Press and hold the two buttons for 1.5s



Disable child lock

9 Indoor Temperature Display

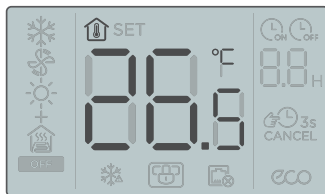

- The indoor temperature is displayed when the screen is off.

10 Project Commissioning

10.1 Restore Factory Default Settings

- Touch and hold \equiv , \otimes and \odot at the same time for 5s, and the wired controller will restart with its parameters restored to the factory settings.

10.2 Error Display

- When the sensor fails, the LCD displays the error code E1 in the Temperature Setting display area;
- In the Parameter Settings interface, the LCD displays the  icon when Modbus communication fails. It always displays if non-networked;
- Notify the distributor of the error code. Do not disassemble, modify or repair the air conditioner without authorization.

10.3 Parameter Settings of the Temperature Controller

- Parameters can be set when the unit is on or off.
- Touch and hold \equiv and \odot for 3s to enter the parameter settings interface.
- After entering the page for parameter settings, C0 is displayed in the temperature display zone. Press \wedge and \vee to switch over to Parameter Code; after selecting Parameter Code, press \odot to enter the specific parameter settings. Press \wedge and \vee to set parameters. Press \odot to save the parameters. Press \odot to exit the parameters without saving parameters.
- If no operation is made in 60s, the page will save your parameters and close.
- When it is in the parameter settings page, the wired controller cannot communicate with Modbus.

Parameter Code	Parameter Name	Parameter Range	Default Value	Remarks
C0	Wired controller address	01-32	01	
C1	Two-pipe/four-pipe selection	00:Two-pipe cooling and heating 01:Two-pipe cooling ★02:Two-pipe cooling +Auxiliary electric heater ★03:Two-pipe heating +Auxiliary electric heater ★04:Two-pipe cooling and heating +Auxiliary electric heater ★05:Four-pipe	00	
C2	ECO cooling temperature setting	17°C to 30°C / 62°F to 86°F	26°C / 79°F	Stepping 0.5°C / 1°F
C3	ECO heating temperature setting	17°C to 30°C / 62°F to 86°F	18°C / 64°F	Stepping 0.5°C / 1°F
C4	Anti-freezing protection	00:Off 01:Start	00	
C5	Anti-freeze temperature setting	0°C to 20°C / 32°F to 68°F	5°C / 41°F	Stepping 0.5°C / 1°F
C6	★Baud rate setting	00:4800 01:9600	01	
C7	Celsius/Fahrenheit	00:°C 01:°F	00	
C8	★Button backlight setting	00:Off 01:On	01	
C9	Language	00:Chinese 01:English	01	
C10	Cooling/Fan temperature compensation	-10°C to 10°C / -18°F to 18°F	0°C / 0°F	Stepping 0.5°C / 1°F
C11	Heating/Auxiliary electric heater temperature compensation	-10°C to 10°C / -18°F to 18°F	0°C / 0°F	Stepping 0.5°C / 1°F
C12	Temperature return difference	1, 2, 3 (°C) / 2, 4, 6 (°F)	1°C / 2°F	
C13	Fan always on/always off (After setting temperature)	00:Always on 01:Always off	0	

Note: The “★” indicates the function is not supported if non-networked.

Parameter Code	Parameter Name	Parameter Range	Default Value	Remarks
C14	Duration of preventing cold wind	00: 0 second 05: 5 seconds 10: 10 seconds 15: 15 seconds 30: 30 seconds 60: 60 seconds 90: 90 seconds	00	
C15	Version		Read only	

10.4 Modbus

- Transmission rate: 9600 bps; Data length: 8 bits; Stop bit: 1 bit; Check bit: no check; Transmission code: hexadecimal value (MODBUS RTU mode); Error detection: CRC-16 (MODBUS RTU mode);
- MODBUS communication IP address of slave unit: 1-32;
- Command = 03: Multi-register read instruction; Command = 06: Single register write instruction;
Command = 16: Multi-register write instruction.

Command	Register Address	Parameter Name	Parameter Range	Default Value
03	1	Thermostat program version No.	1~255	
03	2	Room temperature	Celsius: -50~500; Fahrenheit: 23~122	
03/06/16	3	Current ON/OFF mode	0: OFF; 1: ON	
03/06/16	4	Current setting temperature	17°~30°C / 41°F~95°F	
03/06/16	5	System mode setting	0: Ventilation; 1: Cooling; 2: Heating; 3: Auxiliary electric heater; 4: Heating + Auxiliary electric heater	0
03/06/16	6	Set fan speed	1: Low; 2: Medium; 3: High; 4: Auto	4

Command	Register Address	Parameter Name	Parameter Range	Default Value
03/06/16	7	Fan always on /always off (After setting temperature)	00: OFF; 01: ON	0
03/06/16	8	Select temperature unit	00:°C degrees Celsius 01:°F degrees Fahrenheit	0
03/06/16	9	Cooling/Fan temperature compensation	-10°C~-10°C/ -18°F~-18°F	0C° / 0°F
03/06/16	10	Heating/Auxiliary electric heater temperature compensation	-10°C~-10°C/ -18°F~-18°F	0C° / 0°F
03/06/16	11	Duration of preventing cold wind	00: 0 second 05: 5 seconds 10: 10 seconds 15: 15 seconds 30: 30 seconds 60: 60 seconds 90: 90 seconds	0
03/06/16	12	Temperature return difference	1、2、3 C (°C) / 2、4、6 (°F)	1C° / 2°F
03/06/16	13	Communication IP address (Modbus)	01-32	1
03/06/16	14	Whether anti-freezing protection is enabled	00: OFF; 01: ON	0
03/06/16	15	Anti-freezing setting temperature	0° ~20°C / 32°F~68°F	5°C / 41°F
03/06/16	16	Centralized control locking	00: OFF; 01: ON	0

Command	Register Address	Parameter Name	Parameter Range	Default Value
03/06/16	17	System type	00: Two-pipe cooling and heating 01: Two-pipe cooling 02: Two-pipe cooling +Electric auxiliary heating 03: Two-pipe heating +Electric auxiliary heating 04: Two-pipe cooling and heating +Electric auxiliary heating 05: Four-pipe	0
03	18	Restore factory settings	0: General; 1: Restore factory settings	0
03	19	High fan speed status	00: OFF; 01: ON	0
03	20	Medium fan speed status	00: OFF; 01: ON	0
03	21	Low fan speed status	00: OFF; 01: ON	0
03	22	Valve 1 status	00: OFF; 01: ON	0
03	23	Valve 2 status	00: OFF; 01: ON	0

CAUTION

- The minimum interval of data packet is 100 ms. In case of excessive data in a single data packet, adjust the time interval appropriately.
- The numerical analysis method is different in different temperature systems. At Celsius, the value of the register is 10 times the actual temperature. When setting the register value, the input value should be an integer multiple of 5; In Fahrenheit, the value of the register is equal to the actual temperature, and there is no special provision for setting the register value.

CAUTION

- The default status of Valve1 and Valve 2 will depending on the system state.

11 Installation

11.1 Installation Precautions

- To ensure correct installation, read the "Installation" section of this manual.
- The content provided here covers warnings, which contains important information about safety that must be followed.

CAUTION

- Entrust the local distributor or local service agent to appoint a qualified technician to perform installation. The user must not install the unit.
- Do not disassemble and assemble the product without permission.
- The wiring must be compatible with the wired controller current.
- Use the specified cables, and do not place heavy object on the wiring terminals.

11.2 Installation Accessories

Please check that you have all the following parts.

No.	Name	Qty	Remarks
1	Wired controller	1	
2	Philips head screw, M4×25	2	Used to install the wired controller on the electrical box
3	Installation & Owner's Manual	1	
4	Plastic support bar	2	Used to install the wired controller on the electrical box

Prepare the following parts in the field:

No.	Name	Qty	Remarks
1	Installation box(cassette type)	1	General specifications of the installation box, which is embedded into the wall
2	Shielded 3-core cable	1	RVVP-0.5 mm ² ×3, embedded into the wall (Non-networked without preparation)
3	Control cable (with the null and live wires)	1	1.5 mm ² ×7, embedded into the wall
4	Small slotted screwdriver	1	Used to install the slotted head screws and remove the bottom cover of the wired controller

11.3 Product Dimensions (mm)

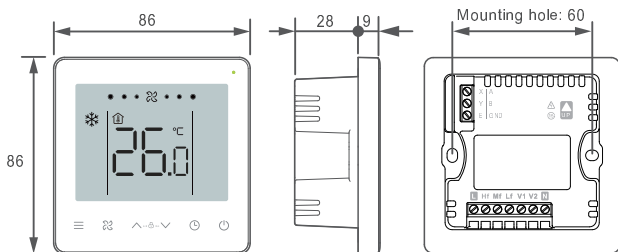

11.4 Installation Method

1. Remove rear cover of the wired controller: insert a slotted-head screwdriver into the bottom buckle of the wired controller, and rotate in the direction indicated to remove the rear cover. Remove the flat cable connecting the front and rear PCBs and remove the front cover of the wired controller.

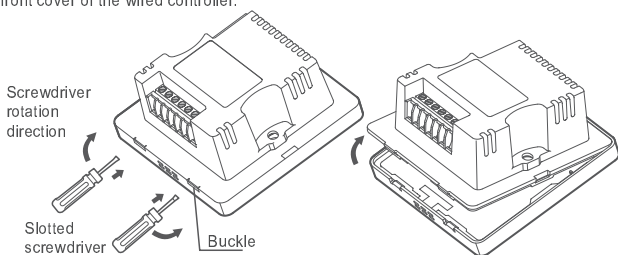

2. Install support bars: Adjust the lengths of the two plastic support bars in the accessories. Ensure that the rear cover of the wired controller stays level with the wall when installed on the screw post of installation box (cassette type).

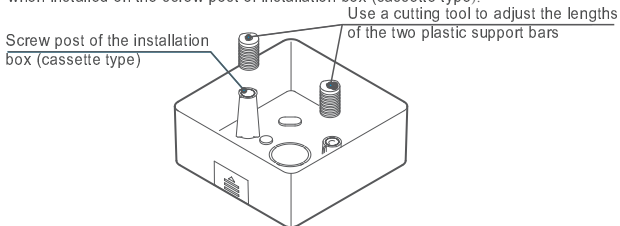

3. Wiring: Connect the cables according to the following wiring drawing

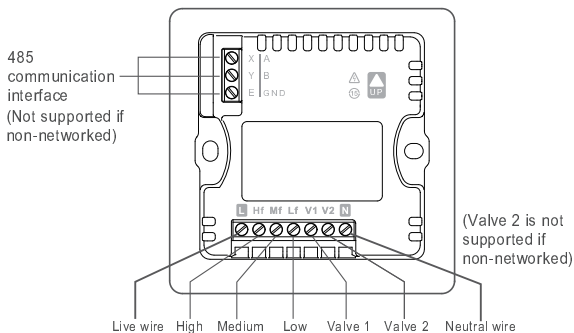

⊘ PROHIBIT

- This product must be installed by a specialized technician. Do not connect cables when the unit is active.
- Do not connect the neutral and live wires to the X/Y/E ends. Otherwise, the wired controller will be burnt.

⚠ WARNING

- Check the wiring before powering on the unit. Wrong wiring may damage the wired controller.

Installation and Wiring diagram

Two-pipe cooling/cooling and heating
(Networked/Non-networked)

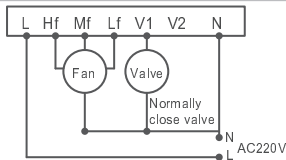

Two-pipe cooling/cooling and heating (Networked)

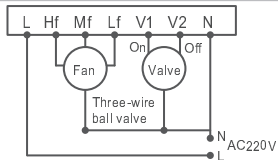

Two-pipe cooling/cooling and heating (Networked)

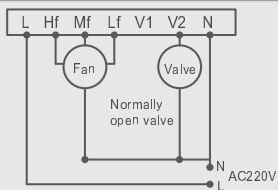

Two-pipe heating + Auxiliary electric heater
Two-pipe cooling + Auxiliary electric heater
Two-pipe cooling and heating + Auxiliary electric heater (Networked)

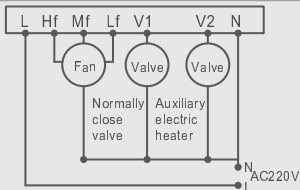

Four-pipe(Networked)

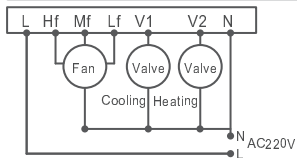

4. Insert the cable of the rear cover into the installation box (cassette type). Use pan head screws to fix the rear cover of the wired controller on the installation box (cassette type); connect the flat cable that connects the front and rear PCBs.

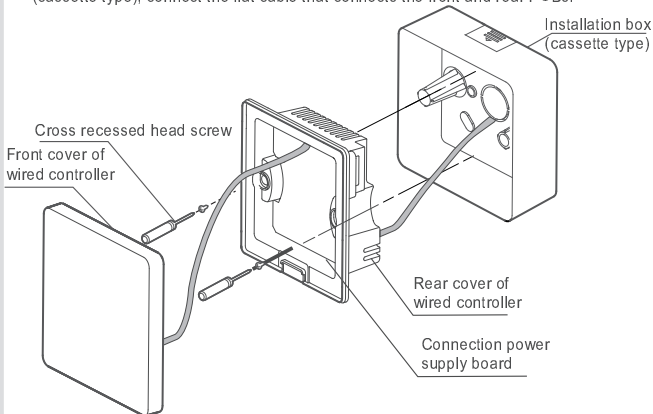

WARNING

- Do not overtighten the pan head screws, otherwise the rear cover of the wired controller may deform and cannot be levelled on the wall surface, which makes it difficult to install or not securely installed.

5. Buckle the front cover of the wired controller on the rear cover as shown in the following figure.

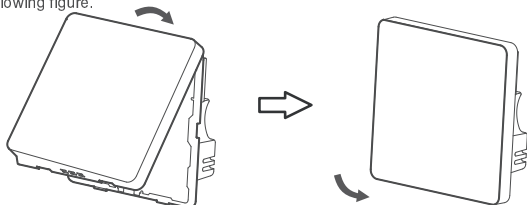

First buckle the upper ends of the front and rear covers of the wired controller.

Then buckle the lower ends of the front and rear covers of the wired controller.

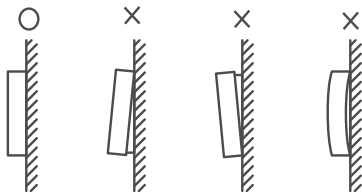

WARNING

- Make sure that no cables are clamped when buckling the front and rear covers.
- The front and rear covers should be installed correctly. Otherwise, the front and rear covers may get loose and fall apart.

16117100002374 V.C

备注说明【此页无需打印】

印刷方式：黑白印刷

材质说明：双胶纸80g

**VA换VB：第五页地暖模式没有风速的描述删除
参数设置更新**

VB换VC：第十页室内温度描述修改