

AIR SOURCE WATER HEAT PUMP

Installation and Instruction Manual

CONTENT

1. Preface	1
2. Safety Precautions	2
2.1 Mark Notes	2
2.2 Icon Notes	2
2.3 Warning	3
2.4 Attention	4
3. Overall information of the heat pump	5
3.1 Device description	5
3.2 Features of the AIR HEAT PUMP	5
3.3 Running Range	6
3.4 New Technology	7
3.5 Running Ambient Temperature Comparison	8
3.6 Functions	8
3.7 Heat Pump Protection	8
3.8 Specification data	9
3.9 Heat pump dimension and view	11
4. Installation	15
4.1 Transit	15
4.2 Installation occasions	15
4.3 Installation method	15
4.4 Water loop connection	16
4.5 Location of the unit	17
4.6 Water connection diagram	18
4.7 Power supply connection	18
4.8 Cable and switch	19
4.9 Trial running	20
5. Controlling and Operation	21
5.1 Main interface display and function	21
5.2 Usage of wire controller	23
5.3 Parameter table	28
6. Troubleshooting and extra information	29
6.1 Maintenance	29
6.2 Malfunction table	30
7. The main controller terminals	32
7.1 The main controller terminals	32
7.2 Connection of PCB illustration	32
7.3 Common observation	33
8. Appendix	34
8.1 Caution & Warning	34
8.2 Cable specification	35

1. Preface

Welcome to air source water heat pump. Your decision to purchase heat pump will reward you for many years.

This is your assurance that you have purchased quality heat pump system available, one that is manufactured in a state-of-the-art facility and goes with innovation.

Necessary reading

Carefully read these operating and installation instructions and keep them safe. Should the equipment change hands, pass these instructions to the subsequent owner. Pass them to the trained contractors for servicing purposes.

Qualified only

Positioning, installation and commissioning must be carried out by trained personnel working in accordance with these *operating and installation instructions*.

Protection

Where children or persons with limited physical, sensory or mental capabilities are to be allowed to control this equipment ensure that this will only happen under supervision or after appropriate instructions by a person responsible for their safety. Children should be supervised to ensure that they do not play with the equipment.

For information

The pictures and drawings in this manual are for your information only. The manufacturer has the right to change or improve the product when it is needed, without prior notification to the users of this device.

Quality check at first receipt of this product

When the product is delivered to the users, please check whether there is any damage on the unit during transportation; If there is any please talk with the forwarder or the contractor.

If the heat pump unit just can be installed a while later, please keep it free from damage, rust or abrasion by following methods.



- 1, all the access like the water connections must be sealed correctly;
- 2, the unit must be free from sunshine, and placed under 45°C;
- 3, the unit must be free from heavy dust to avoid dirt on the evaporator;
- 4, the unit must be placed free from chaos to avoid accident.
- 5, please check the unit during stock

2. Safety Precautions



To prevent the users and others from the harm of this unit, and avoid damage on the unit or other property, and use the heat pump properly, please read this manual carefully and understand the following information correctly.

The piping connection and wiring should be installed according to the local legal laws and regulations as well as the profession standard.

Mark Notes



Mark	Meaning
 WARNING	A wrong operation may lead to death or heavy injury on people.
 ATTENTION	A wrong operation may lead to harm on people or loss of material.



Icon Notes



Icon	Meaning
	Prohibition. What is prohibited will be nearby this icon
	Compulsory implement. The listed action need to be taken.
	ATTENTION (include WARNING) Please pay attention to what is indicated.

2. Safety Precautions

Warning



Installation	Meaning
 Professional installer is required.	The heat pump must be installed by qualified personals, to avoid improper installation which can lead to water leakage, electrical shock or fire.
 Earthing is required	Please make sure that the unit and power connection have good earthing, otherwise may cause electrical shock.





Operation	Meaning
 PROHIBITION	DO NOT put fingers or others into the fans and evaporator of the unit, otherwise harm may be occurred.
 Shut off the power	When there is something wrong or strange smell, the power supply need to be shut off to stop the unit. Continue to run may cause electrical short or fire.

Move and repair	Meaning
 Entrust	When the heat pump need to be moved or installed again, please entrust dealer or qualified person to carry it out. Improper installation will lead to water leakage, electrical shock, injury or fire.
 Entrust	When the heat pump need to be repaired, please entrust dealer or qualified person to carry it out. Improper movement or repair on the unit will lead to water leakage, electrical shock, injury or fire.
 Prohibit	It is prohibited to repair the unit by the user himself, otherwise electrical shock or fire may be occur.

2. Safety Precautions

Attention

Installation	Meaning
 Installation Place	The unit CANNOT be installed near the flammable gas. Once there is any leakage of the gas, fire can occur.
 Fix the unit	Make sure that the basement of the heat pump is strong enough, to avoid any decline or fall down of the unit
 Need circuit breaker	Make sure that there is circuit breaker for the unit, lack of circuit breaker can lead to electrical shock or fire.

Operation	Meaning
 Check the installation basement	Please check the installation basement in a period (one month), to avoid any decline or damage on the basement, which may hurt people or damage the unit
 Switch off the power	Please switch off the power for clean or maintenance.
 Prohibition	It is prohibited to use copper or iron as fuse. The right fuse must be fixed by electrician for the heat pump.
 Prohibition	It is prohibited to spray the flammable gas to the heat pump, as it may cause fire.

3. Overall information of the heat pump

3.1 Device description

The air source heat pump extracts heat from ambient air and transfer it to water. By circulating the water, the energy is used to warm the house efficiently. Through the usage of floor heating, the heat pump COP can be as high as 4.5.

In reverse, cooling is also available when it is needed.

Compared with oil boiler, gas boiler and electrical heater, heat pump is the best solution with high efficiency, safety and environment protect.

This air source heat pump use advanced heating technology and intelligent control system, to produce hot water at maximum temperature of 65°C for all applications coupled with radiators, fan coils and floor heating.

In addition, the air heat pump can be used to provide hot water for sanitary use, like kitchen, shower, etc.

3.2 Features of the AIR HEAT PUMP

1, Save our planet---earth, by green technology

Heat pump transfer heat from air to the space for heating, so that there is no burning, no waste, no dirty gas, thus maintain good environment for human and save earth from waste.

2, Serve people by high efficiency and money saving

The heat pump is driven by electricity, and annually average efficiency can be higher than 4. By timer function, users can make use of the electric power at the low point of a day, thus save money for every family.

3, Good for life with safe running

To use heat pump for heating can avoid electrical shot and burning, thus keep people free from explosion or poisoning.

4, Easy operation

Heat pump is controlled and protected by micro-computer based controller, the desired water temperature is set according to real requirement. System protection program will guarantee the unit to be running at hard environment.

3. Overall information of the heat pump

3.3 Running Range

PASHW050S-PS/PASHW100S-PS/ PASHW150S-PS/PASHW300S-PS

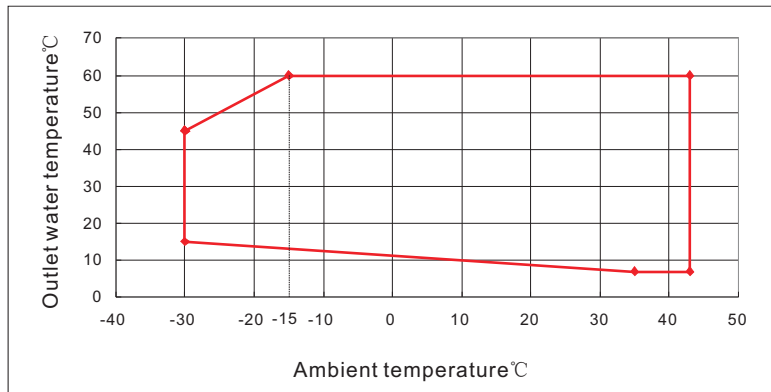

3. Overall information of the heat pump

3.4 New Technology

(1) EVI Strong Heating Technology

Compared with normal heat pump system, heat pump with EVI greatly improves the system running safety in low ambient temperature. Meanwhile, COP is increased by 15% and heating capacity is increased by 20%.

(2) Low Ambient Temperature Heating Technology

The heat pump can work efficiently and safely at -30°C ambient temperature.

(3) High COP

The COP of heat pump can reach 4.0 at rated heating condition.

3. Overall information of the heat pump

3.5 Running Ambient Temperature Comparison

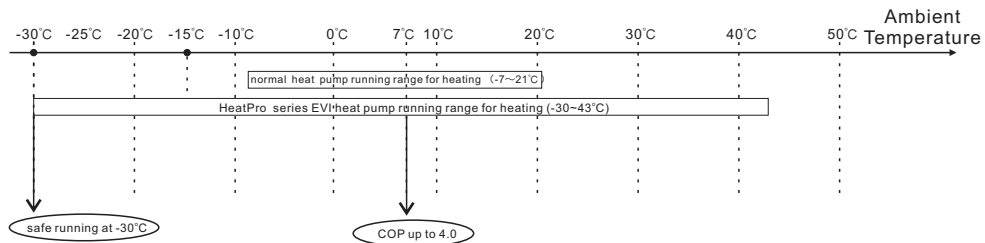

3.6 Functions

- Heating/Cooling
- Smart defrost
- Auto Protection
- Multiple Module Control
- Automatic Reset for Partial Failure
- Auto Alert
- Remote Control

3.7 Heat Pump Protection

- Water flow protection
- Compressor overload, discharge air temp protection
- Discharge air pressure over high protection
- Suction air pressure over low protection
- Water(out) temperature over high protection
- Water(out) temperature over low protection
- Suspend anti-freezing protection in winter
- Compressor frequent switching protection

3. Overall information of the heat pump

3.8 Specification data

Model		PASRW050S-PS	PASRW100S-PS
*Heating Capacity	kW	19.0	36.5
	kcal/h	16337	31384
**Heating Capacity	kW	15.9	31.4
	kcal/h	13672	26999
***Heating Capacity	kW	15.7	31.1
	kcal/h	13500	267411
Cooling Capacity	kW	11.5	18.0
	kcal/h	9888	15477
*Power Input for Heating	kW	4.1	7.8
**Power Input for Heating	kW	5.3	10.6
***Power Input for Heating	kW	3.47	7.4
Power Input for Cooling	kW	4.0	7.5
Running Current (*Heating/**Heating/***Heating/Cooling)	A	7.1/8.2/6.0/6.9	13.5/18.4/12.8/13.0
Power Supply		380V/3N~/50Hz	380V/3N~/50Hz
Compressor Quantity		1	2
Compressor Type		EVIScroll	EVIScroll
Fan Quantity		2	2
Fan Power Input	W	140×2	300×2
Fan Rotate Speed	RPM	850	875
Noise	dB(A)	60	65
Water Connection	inch	1	1.5
Water Flow Rate	m ³ /h	2.6	5.2
Water Pressure Drop	kPa	60	53
Unit Dimension (L/W/H)	mm	(Subject to drawings of the heat pump)	
Packing Size (L/W/H)	mm	(Subject to data on the package)	
Net Weight	kg	(Subject to data on the nameplate)	
Gross Weight	kg	(Subject to data on the package)	

- 1.*Hot Water: outdoor temperature DB/WB20°C/15°C , outlet water circulation from 15°C to 55°C ;
- 2.**Heating: outdoor temperature DB/WB7°C/6°C , outlet water 55°C, inlet water (return) 50°C;
- 3.***Heating: outdoor temperature DB/WB7°C/6°C , outlet water 35°C, inlet water (return) 30°C;
- 4.Cooling: outdoor temperature DB/WB35°C/24°C , outlet water 7°C, inlet water (return)12°C .

3. Overall information of the heat pump

Model		PASRW150S-PS	PASRW300S-PS
*Heating Capacity	kW	50	100.0
	kcal/h	42992	85984
**Heating Capacity	kW	43	86.0
	kcal/h	36973	73947
***Heating Capacity	kW	42	84.0
	kcal/h	36114	72227
Cooling Capacity	kW	27.3	59.0
	kcal/h	23473	46948
*Power Input for Heating	kW	10.8	22.0
**Power Input for Heating	kW	14.5	29.0
***Power Input for Heating	kW	10	20.0
Power Input for Cooling	kW	10.6	21.9
Running Current (*Heating/**Heating/**Heating/Cooling)	A	19.2/25.8/17.8/18.8	46.7/61.5/42.4/46.5
Power Supply		380V/3N~/50Hz	380V/3N~/50Hz
Compressor Quantity		1	2
Compressor Type		EVIScroll	EVIScroll
Fan Quantity		1	2
Fan Power Input	W	1100×1	1100×2
Fan Rotate Speed	RPM	900	900
Noise	dB(A)	68	73
Water Connection	inch	1.5	DN80 Flange
Water Flow Rate	m ³ /h	8.5	17
Water Pressure Drop	kPa	60	65
Unit Dimension (L/W/H)	mm	(Subject to drawings of the heat pump)	
Packing Size (L/W/H)	mm	(Subject to data on the package)	
Net Weight	kg	(Subject to data on the nameplate)	
Gross Weight	kg	(Subject to data on the package)	

- 1.*Hot Water: outdoor temperature DB/WB20°C/15°C , outlet water circulation from 15°C to 55°C ;
- 2.**Heating: outdoor temperature DB/WB7°C/6°C , outlet water 55°C. inlet water (return) 50°C;
- 3.***Heating: outdoor temperature DB/WB7°C/6°C , outlet water 35°C, inlet water (return) 30°C;
- 4.Cooling: outdoor temperature DB/WB35°C/24°C , outlet water 7°C, inlet water (return)12°C .

3. Overall information of the heat pump

3.9 Heat pump dimension and view

Model: PASRW050S-PS

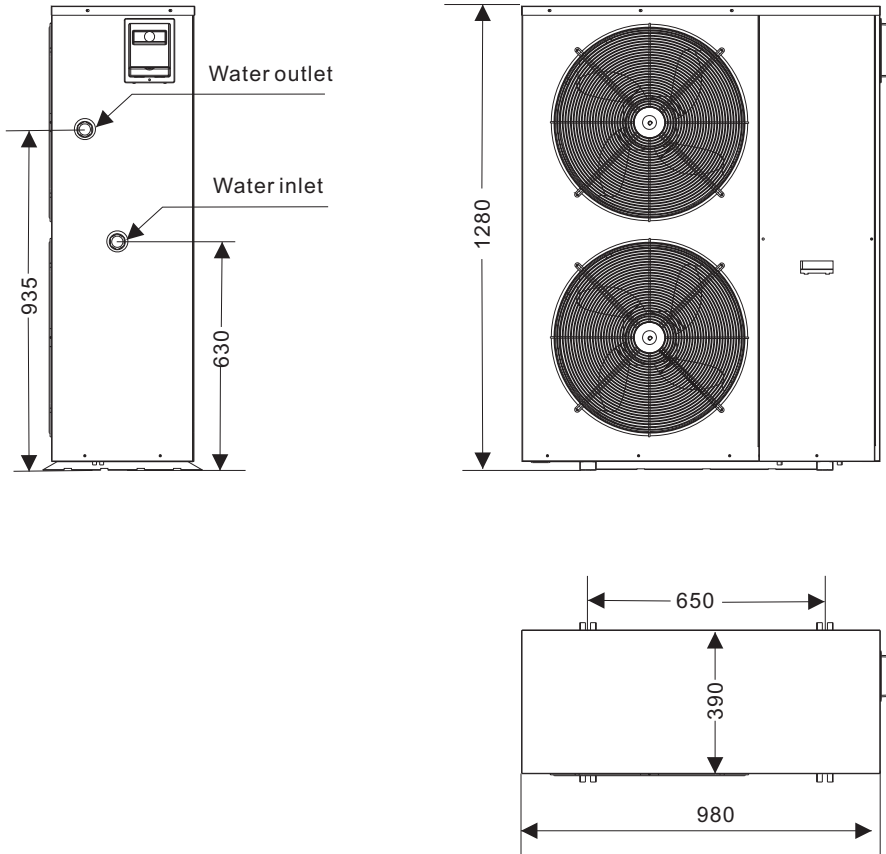

3. Overall information of the heat pump

Model: PASRW100S-PS

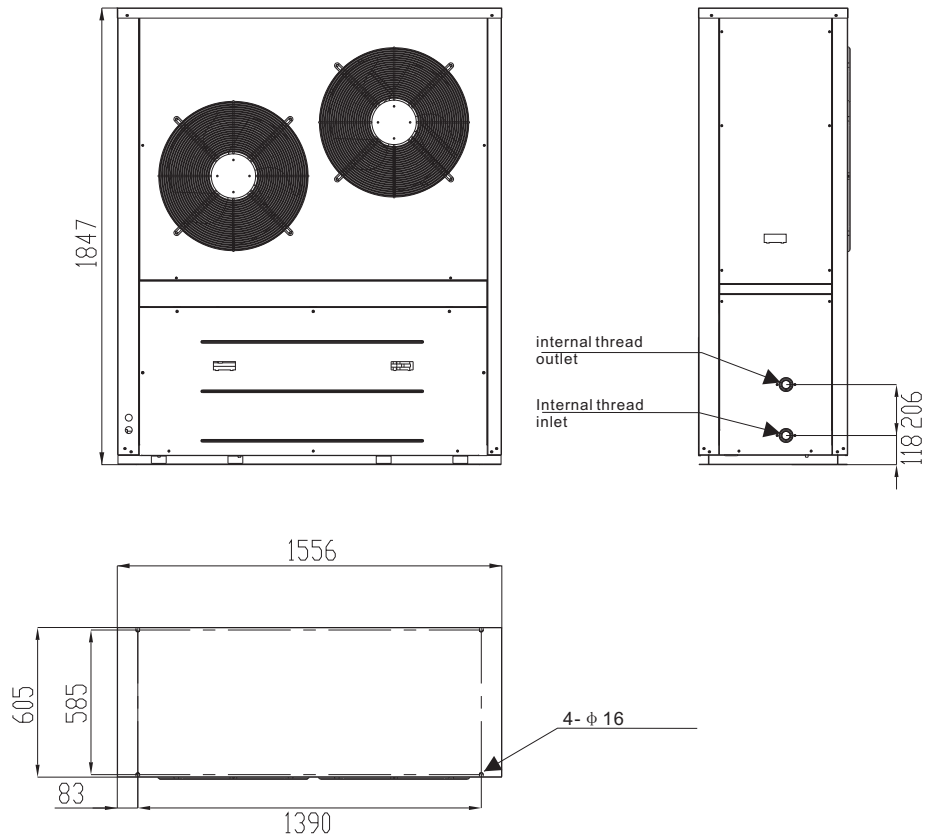

3. Overall information of the heat pump

Model: PASRW150S-PS

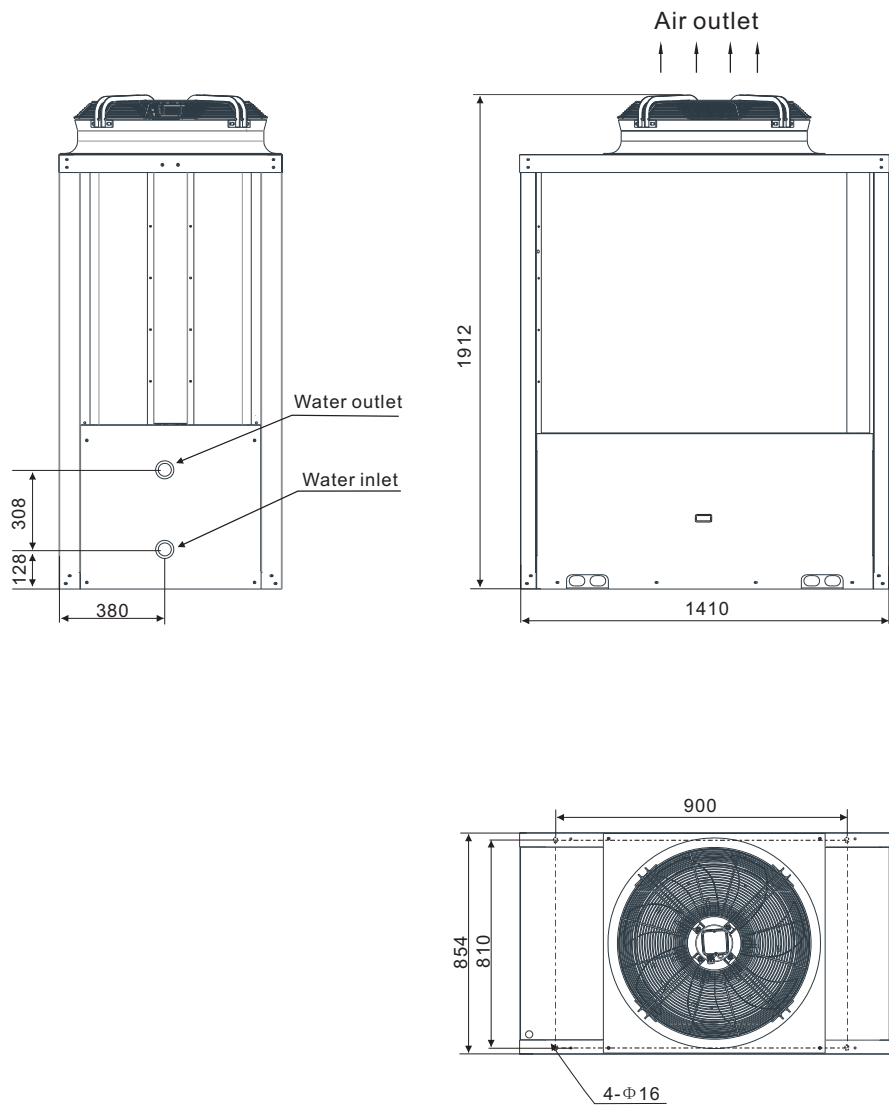

3. Overall information of the heat pump

Model: PASRW300S-PS

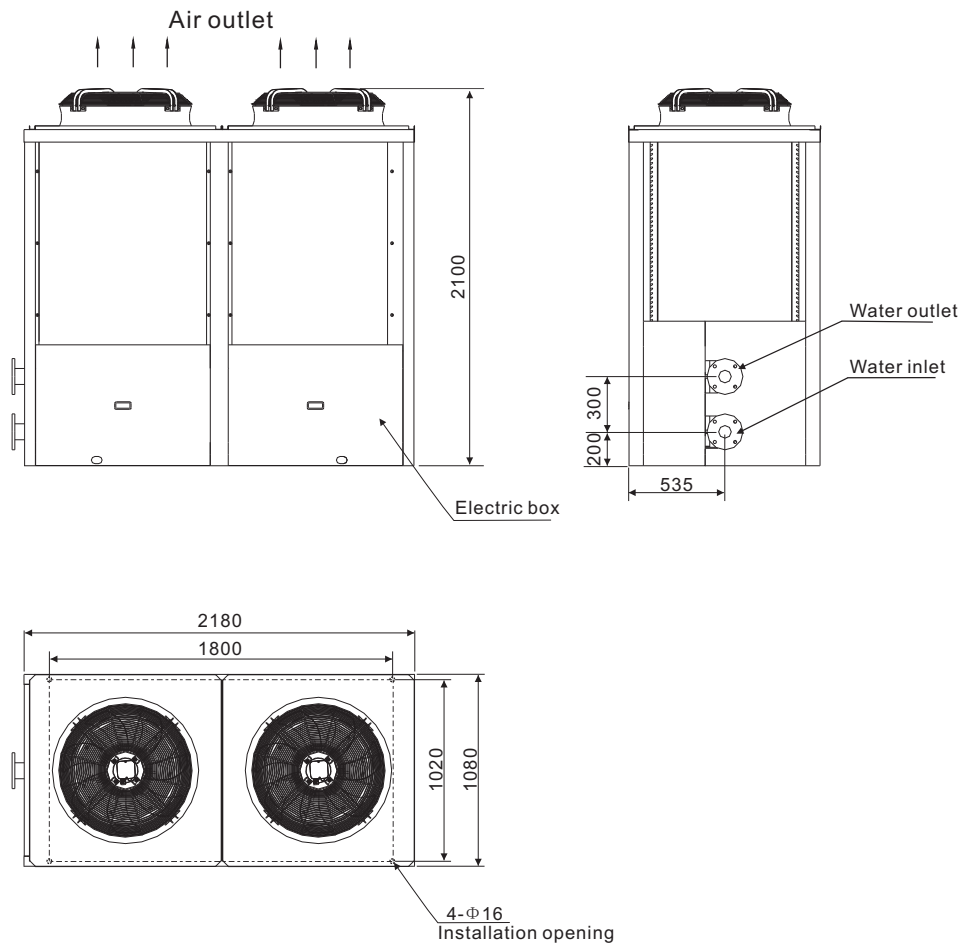

4. Installation

4.1 Transit

When the heat pump is transported please keep the unit stand up. The unit cannot be laid down, otherwise the inner parts of the device may be damaged.

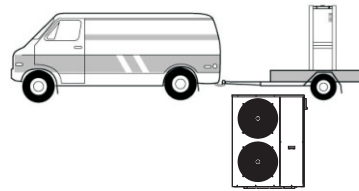

When the unit need to be hung up during installation, a 8 metres cable is needed, and there must be soft material between the cable and the unit to prevent damage to the heat pump cabinet. (See picture 1)

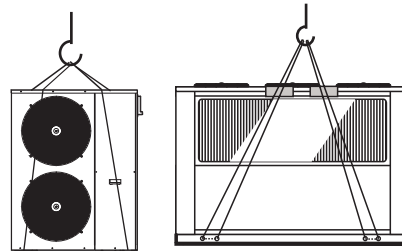

Picture 1

Picture 2

Or please use forklift, since there is wood chassis as package.

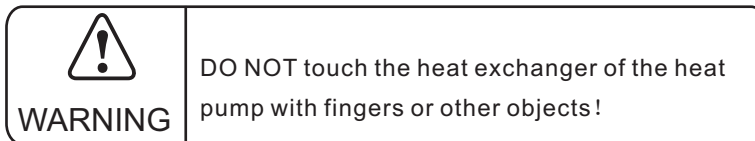

4.2 Installation occasions

- The unit can be installed on any place outdoor which can carry heavy machine such as terrace, housetop, ground and so on.
- The location must have good ventilation.
- The place is free from heat radiation and other fire flame.
- A pall is needed in winter to protect the heat pump from snow. (See picture 2)
- There must be not obstacles near the air inlet and outlet of the heat pump.
- There must be water channel around the heat pump to drain the condensing water .
- A place which is free from strong air blowing.
- There must be enough space around the unit for maintenance.

4.3 Installation method

The heat pump can be installed onto the concrete basement by expansion screws, or onto a steel frame with rubber feet which can be placed on the ground or housetop.

Make sure that the unit is placed horizontally.

4. Installation

Picture 3: Snow shelter

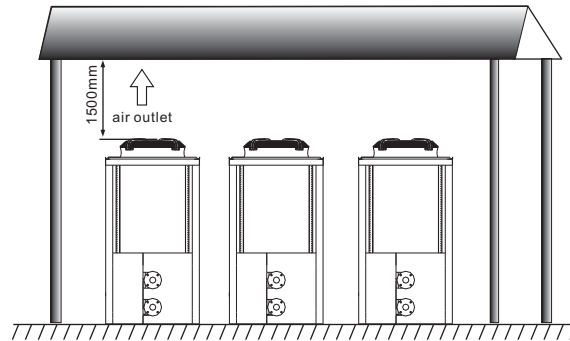

Attention

Snow shelter is necessary if the heat pump has to work normally at cold area in winter.

4.4. Water loop connection

Please pay attention to below matters when the water pipe is connected:

- Try to reduce the resistance to the water from the piping.
- The piping must be clear and free from dirty and blocks. Water leakage test must be carried out to ensure there is no water leaking. And then the insulation can be made.
- Attention that the pipe must be tested by pressure separately. DO NOT test it together with the heat pump.
- There must be expansion tank on the top point of the water loop, and the water level in the tank must be at least 0.5 meter higher than the top point of the water loop.
- The flow switch is installed inside of the heat pump, check to ensure that the wiring and action of the switch is normal and controlled by the controller.
- The connection between the heat pump and the construction is better to be flexible type, to avoid vibration transfer. The support to the water pipe must be separate, but not rely on the heat pump unit
- Try to avoid air stayed inside of the water pipe, and there must be air vent on the top point of the water loop.
- There must be thermometer and pressure meter at the water inlet and outlet, for easy inspection during running.
- There must be drainage on the low points of the water system, and there is already drainage on the chassis of the heat pump. The water in the system must be drain out during winter if the heat pump is not running. And there must be air vent on the high point of the water system to drive air of the water. Drainage and air vent need not to be insulated, in order to maintain.

4. Installation

4.5. Location of the unit

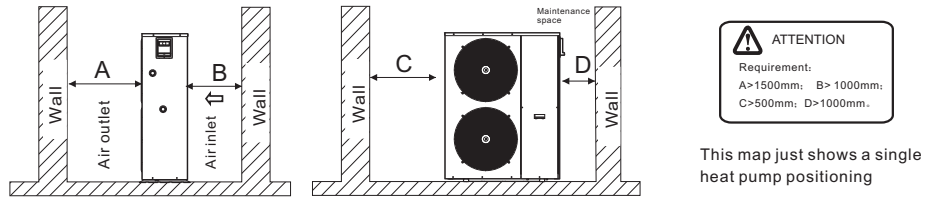

The size of unit

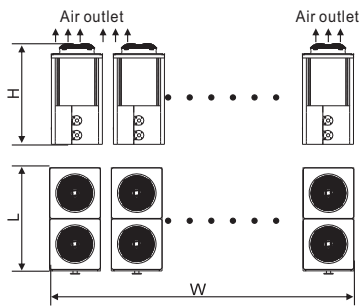

Parallel model	L(mm)	W(mm)	H(mm)
two units	2180	3160	2100
three units	2180	5240	2100
four units	2180	7320	2100
five units	2180	9400	2100

The schematic diagram of installation

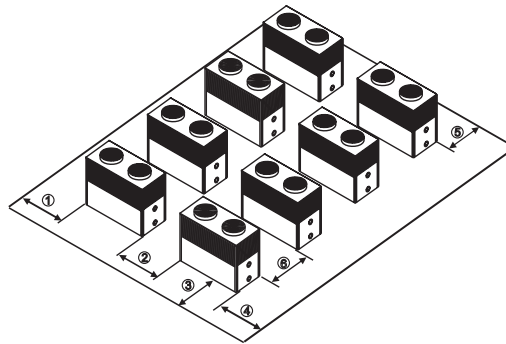

1	The place for maintenance more than 1500mm
2	The distance between two units more than 1500mm
3	The place for maintenance more than 1500mm
4	The place for maintenance more than 1500mm
5	The place for maintenance more than 1200mm

4. Installation

4.6 Water connection diagram

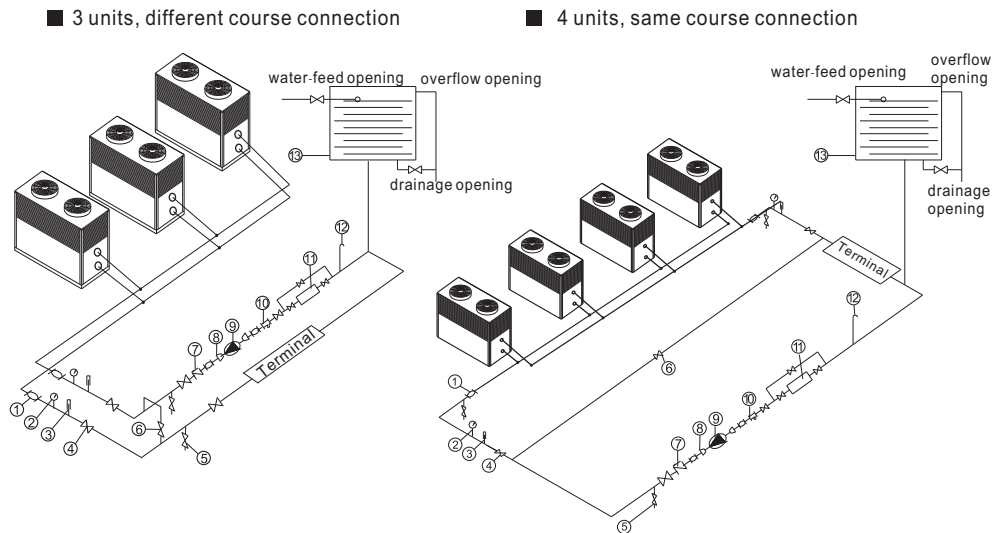

1	rubber connector	4	adjusting valve	7	one way valve	10	Y filter	13	expansion tank
2	gauge	5	drain valve	8	reducer union	11	electric scale-borer		
3	thermometer(0-100°C)	6	bypass valve	9	water pump	12	discharge valve		

4.7. Power supply connection

- Open the front panel, and open the power supply access.
- The power supply must go through the wire access and be connected to the power supply terminals in the controlling box. Then connect the 3-signal wire plugs of the wire controller and main controller.
- If the outside water pump is needed, please insert the power supply wire into the wire access also and connect to the water pump terminals.
- If an additional auxiliary heater is need to be controlled by the heat pump controller, the relay (or power) of the aux-heater must be connected to the relevant output of the controller.

4. Installation

4.8 Cable and switch

- The unit should use independent power supply, Wiring required by Table 6.1, Power supply voltage must in line with rated voltage.
- Power supply circuit must be equipped with an All-pole disconnect device have at least 3mm contact opening distance.
- The wiring must be completed by professional technicians in accordance with circuit diagram.
- Power supply circuit must have earth wire, the earth wire of power should be connected with external earth wire safely. And the external earth wire must be in order.
- The creepage protection device must be settled in accordance with the relevant national technical standards for electronic equipment.
- The power wire and signal wire should be neatly arranged. High voltage wire and low voltage wire must be separated and free from any interference, and they must be free from any pipe and valves of the unit.
- When all the wiring is completed, the power can only be connected after a double check.

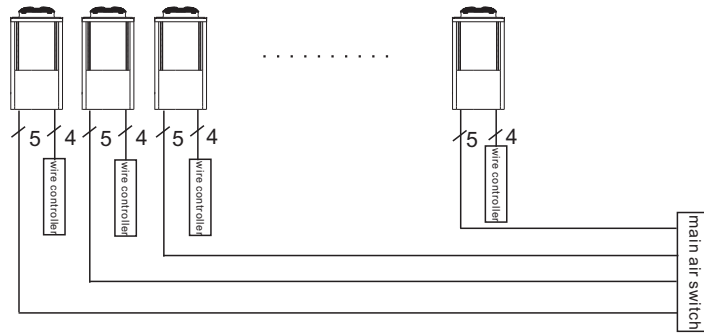

Power Specifications

Items Unit Model	Power Supply	Cable		MCB	Creepage Protector
		Section area	Earthing wire		
PASHW050S-PS	380V/3N~50Hz	4×4mm ²	2.5mm ²	40A	30mA Less Than 0.1 SET
		5×16mm ²	16mm ²		
PASHW100S-PS	380V/3N~50Hz	5×16mm ²	16mm ²	80A	30mA Less Than 0.1 SET
		5×16mm ²	16mm ²		
PASHW150S-PS	380V/3N~50Hz	5×16mm ²	16mm ²	80A	30mA Less Than 0.1 SET
		5×16mm ²	16mm ²		
PARSW300S-PS	380V/3N~50Hz	25×4mm ²	25mm ²	100A	30mA Less Than 0.1 SET
		25×4mm ²	25mm ²		

4. Installation

4.9 Trial running

Inspection before trial running

- Check the indoor unit, and make sure that the pipe connection is right and the relevant valves are open .
- Check the water loop, to ensure that the water inside of the expansion tank is enough, the water supply is good, the water loop is full of water and without any air. Also make sure there is good insulation for the water pipe.
- Check the electrical wiring. Make sure that the power voltage is normal, the screws are fastened, the wiring is made in line with the diagram, and the earthing is connected.
- Check the heat pump unit including all of the screws and parts of the heat pump to see if they are in good order. When power on, review the indicator on the controller to see if there is any failure indication. The gas gauge can be connected to the check valve to see the high pressure(or low pressure) of the system during trial running.

Trial running

- Start the heat pump by press "  " key on the controller. Check whether the water pump is running, if it runs normally there will be 0.2 MPa on the water pressure meter.
- When the water pump runs for 1 minutes, the compressor will start. Hear whether there is strange sound from the compressor. If abnormal sound occurs please stop the unit and check the compressor. If the compressor runs well please look for the pressure meter of the refrigerant.
- Then check whether the power input and running current is in line with the manual. If not please stop and check.
- Adjust the valves on the water loop, to make sure that the hot(cool) water supply to each door is good and meet the requirement of heating(or cooling).
- Review whether the outlet water temperature is stable.
- The parameters of the controller are set by the factory, it is not allowed to change then by user himself.

5. Controlling and Operation

5.1. Main interface display and function

(1) Power on interface



(2) Starting up interface

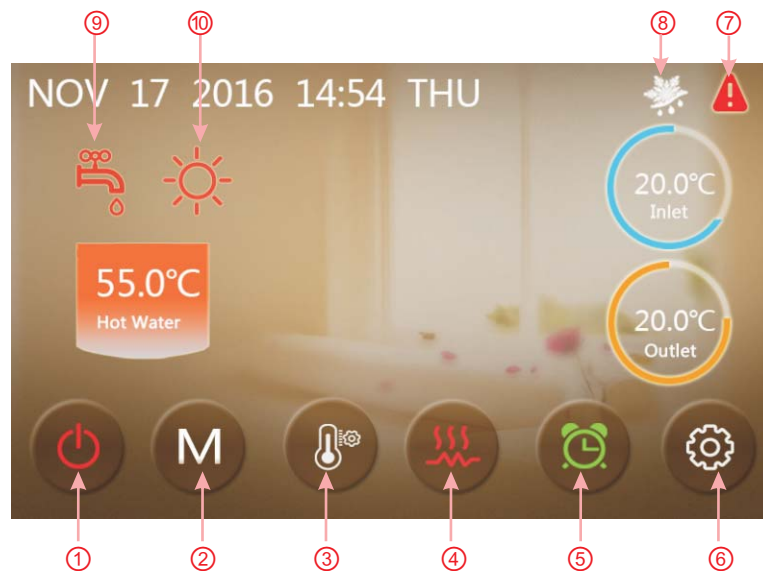

5. Controlling and Operation

Key function

Key number	Key name	Key function
①	On and off	Click this key to switch ON or OFF Red represents ON, while grey represents OFF
②	Mode key	Hot water mode, heating mode, cooling mode, hot water+heating mode or hot water+cooling mode can be selected by pressing this key.
③	Temperature setting	Click this key to set the target temperature
④	Fast heating	Click this key to start the rapid heating This key will be displayed during heating
⑤	Timer setting	Click this key to set the timer White represents not enabled, while green represents enabled
⑥	Setup key	Click this key to check the unit status, time, factory parameter, temperature curve, timer setting and Mute setting
⑦	Fault icon	This icon will flash when there is an error shown up, then the display will enter Failure record interface after tapping this icon.

Note:

- ⑧ is defrosting icon, the machine is in defrosting mode when this icon is shown;
- ⑨ is hot water mode icon, this machine is in hot water mode when this icon is shown;
- ⑩ is heating mode icon, this machine is in heating mode when this icon is shown.

5. Controlling and Operation

5.2 Usage of wire controller

1. On and off

On and off .As the main interface shows

(1) .In shutting down interface (on/off key is in gray status),
press on/off key can start up the machine.

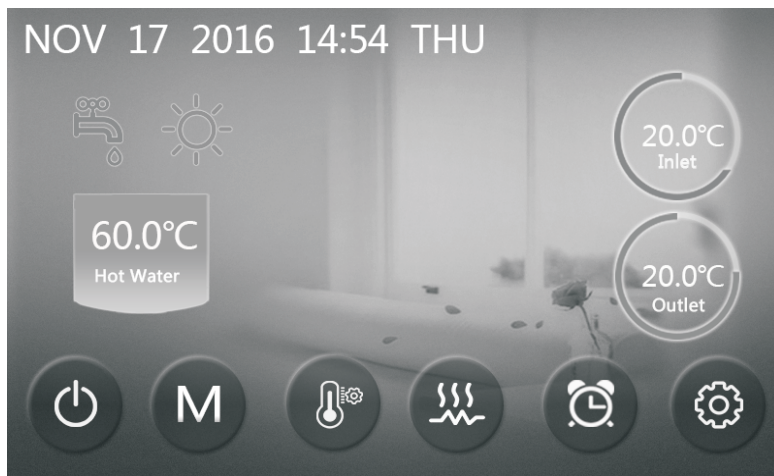

(2) Note: In starting up interface (on/off key is in red status),
press on/off key can shut down the machine.

2. Mode switch



5. Controlling and Operation

In the main interface, there are five modes can be selected after tapping the mode key.

- (1) tapping hot water mode icon ①, then the display will change to this mode interface;
- (2) tapping heating mode icon ②, then the display will enter this mode interface;
- (3) tapping cooling mode icon ③, then the display will switch to this mode interface;
- (4) tapping hot water+heating mode icon ④, then the display will go into hot water+heating mode interface;
- (5) tapping hot water+cooling mode icon ⑤, then the display will come to hot water+cooling mode interface;

Note: If what you have purchased is a cooling-only or heating-only model, the mode switch will be invalid.

3. Setting of target temperature



Take hot water + cooling mode for example;

Tapping ①, the wire controller back to main interface;

Tapping ②, the target temp of hot water can be set by pop-up keyboard;

Tapping ③, the target temp of cooling mode can be set by pop-up keyboard.

5. Controlling and Operation

4. When the target temp is being set, pop-up keyboard is shown as following:

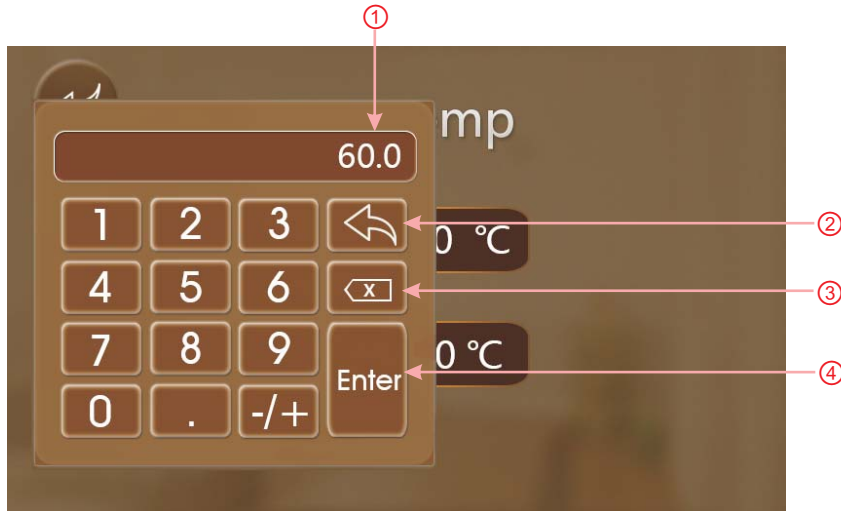

Key number	Key name	Key function
②	Return key	Tapping this key can back to the main interface.
③	Delete key	Tapping this key to undo the last action.
④	Enter key	Tapping this key can save you action and back to the main interface.

Note: ① means the new target temp under current setting

5. Controlling and Operation

5. Fast heating

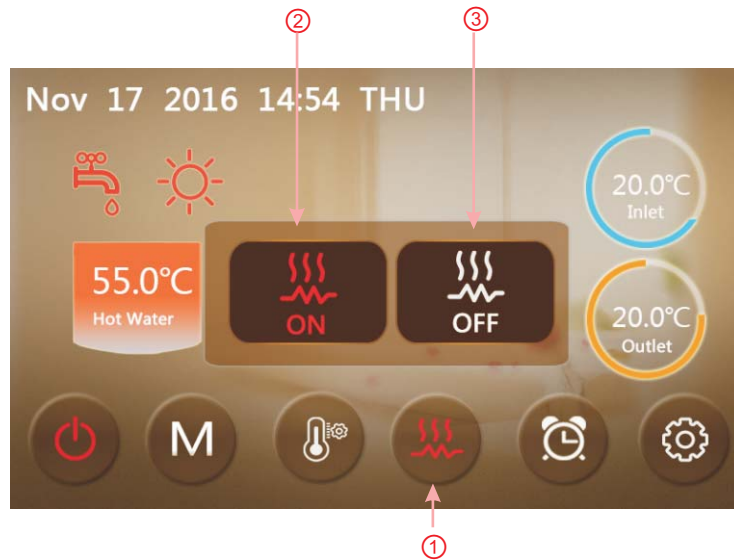

Under the heating mode, click the fast heating key ① the above interface will appear. Click ② to start the fast heating and click ③ to close it.

6. Timer setting

Click the timer setting key to enter the timer setting and the interface display is as follows:

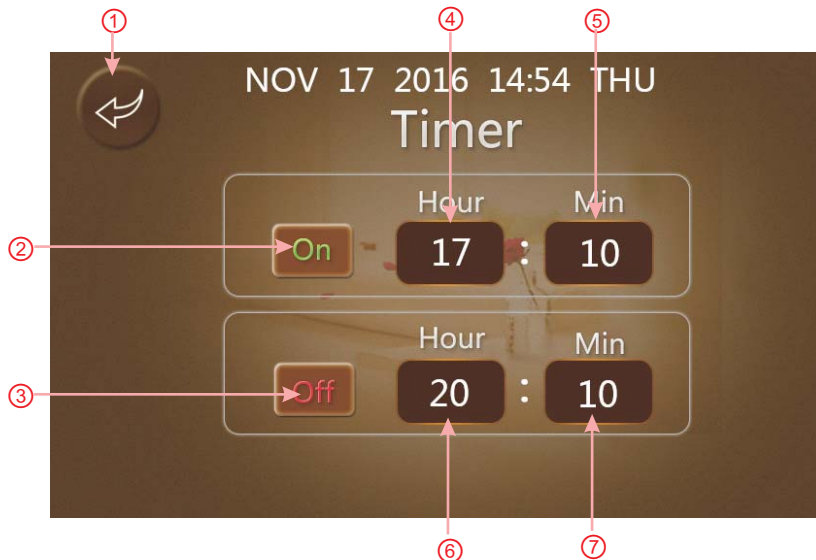

5. Controlling and Operation

Key number	Key name	Key color	Key function
①	Return key		Click this key to return to the main interface.
②	Enable the timer on	Enable: Green ON Disable: Gray OFF	Click this key to start or turn off the timed start-up function
③	Enable the timer off	Enable: Red ON Disable: Gray OFF	Click this key to start or turn off the timed shutdown function
④	Hour of timer on		Hour of Timer on is shown
⑤	Minute of timer on		Minute of Timer on is shown
⑥	Hour of timer off		Hour of Timer off is shown
⑦	Minute of timer off		Minute of Timer off is shown

Such as the above figure: Under the state of unmanned operation, it will start the timed start-up at 17:10 and will be timed shutdown when running to 20:10 .

7. Fault interface

Click the fault icon on the main interface and the interface display is as follows:

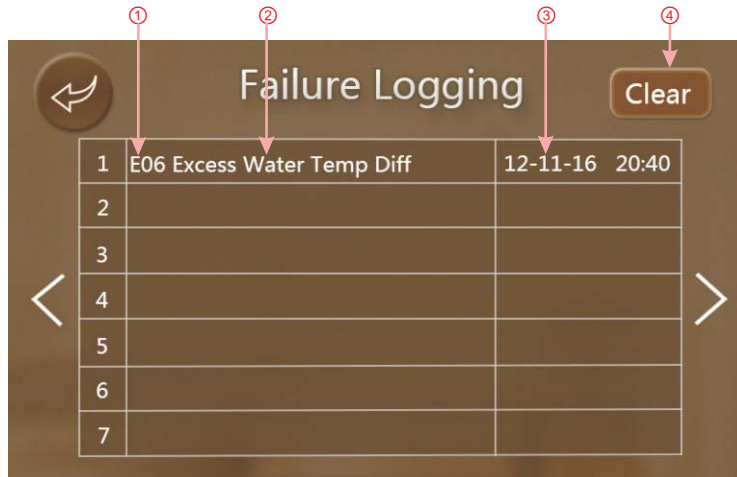

5. Controlling and Operation

Note:

- ①: Fault code
- ②: Fault name
- ③: Occurrence time of the fault, Day, month and year hour: second (s)
- ④: Click this key to clear all fault records

5.3 Parameter table

Meaning	Default	Remarks
Set-point of cooling target temp.	12℃	Ajustable
Set-point of heating target temp.	50℃	Ajustable

6. Troubleshooting and extra information

6.1 Maintenance

- Check the water supply and air vent frequently, to avoid lack of water or air in the water loop. Clean the water filter in a certain period to keep good water quality. Lack of water and dirty water can damage the unit. The heat pump will start the water pump per 72 hours when it is not running, to avoid freezing.
- Keep the unit in a place which is dry and clean, and has good ventilation. Clean the heat exchanger in 1 or 2 month and keep good heat exchange rate and save energy.
- Check each part of the unit and the pressure of the system. Replace the failure part if there is any, and recharge the refrigerant if it is needed.
- Check the power supply and the electrical system, make sure the electrical components are good, the wiring is well. If there is any part failed with wrong action or smell, please replace in time.
- If the heat pump is not used for a long time, please drain out all the water in the unit and seal the unit to keep it good. Please drain the water from the lowest point of the heat exchanger to avoid freezing in winter. Water recharge and full inspection on the heat pump is needed before it is restarted.
- Please drain out the water in the super heater of the heat pump unit in winter, when the super heater is not used, in case it is heat pump with super heater.
- The water loop of the heat pump MUST be protected from freezing in winter time. Please pay attention to below suggestions. Nonobservance on below suggestion will invalid the warranty for the heat pump.

(1) Please do not shut off the power supply to the heat pump in winter. When the air temperature is below 0 °C, if the inlet water temperature is above 2 °C and below 4°C, the water pump will start for freezing protect, if the inlet water is lower than 2 °C, the heat pump will run for heating.

(2) Use anti-freezing liquid (glycol water)

1) look for below table for the volume of the glycol water

2) the glycol water can be added into the system from the expansion tank of the water loop.

Glycol percentage (%)	10	20	30	40	50
ambient temp. (°C)	-3	-8	-14	-22	-33
cooling/heating capacity fluctuation	0.991	0.982	0.972	0.961	0.946
power input fluctuation	0.996	0.992	0.986	0.976	0.966
water flow fluctuation	1.013	1.040	1.074	1.121	1.178
water drop fluctuation	1.070	1.129	1.181	1.263	1.308

Note: if the glycol water is too much, the water flow and water pump will be influenced and the heat exchange rate will be decreased. This table is for reference, please use anti-freezing water according to the real condition of the local climate.

6. Troubleshooting and extra information

6.2 Malfunction table

You can refer to the malfunction table to find out the failure cause and solution.

Protect/fault	Fault display	Reason	Elimination methods
Standby	Non		
Normal boot	Non		
Inlet Temp Sensor Fault	P01	The temp. Sensor is broken or short circuit	Check or change the temp. Sensor
Outlet Temp Sensor Fault	P02	The temp. Sensor is broken or short circuit	Check or change the temp. Sensor
Water Tank Temp Sensor	P03	The temp. Sensor is broken or short circuit	Check or change the temp. Sensor
AT Sensor Fault	P04	The ambient temp. Sensor is broken or short circuit	Check or change the temp. Sensor
Syst1:Coil temp1 Sensor	P153	The temp. Sensor is broken or short circuit	Check or change the temp. Sensor
Syst1:Coil temp2 Sensor	P154	The temp. Sensor is broken or short circuit	Check or change the temp. Sensor
Syst1:Suction temp Sensor	P17	The temp. Sensor is broken or short circuit	Check or change the temp. Sensor
Syst1:Antifreeze Sensor1(US)	P191	The temp. Sensor is broken or short circuit	Check or change the temp. Sensor
Syst1:Antifreeze Sensor2(US)	P193	The temp. Sensor is broken or short circuit	Check or change the temp. Sensor
Syst1:Antifreeze Sensor4(HSS)	P195	The temp. Sensor is broken or short circuit	Check or change the temp. Sensor
Syst1:Inlet Sensor(EVI)	P101	The temp. Sensor is broken or short circuit	Check or change the temp. Sensor
Syst1:Outlet Sensor(EVI)	P102	The temp. Sensor is broken or short circuit	Check or change the temp. Sensor
Syst1:Exhaust temp Sensor	P181	The temp. Sensor is broken or short circuit	Check or change the temp. Sensor
Syst1:Pressure Sensor fault	PP11	The system 1 pressure Sensor is broken or short circuit	Check or change the pressure Sensor or pressure
Syst2:Coil temp Sensor	P25	The temp. Sensor is broken or short circuit	Check or change the temp. Sensor
Syst2:Suction temp Sensor	P27	The temp. Sensor is broken or short circuit	Check or change the temp. Sensor
Syst2:Antifreeze Sensor1(US)	P291	The temp. Sensor is broken or short circuit	Check or change the temp. Sensor
Syst2:Antifreeze Sensor2(US)	P293	The temp. Sensor is broken or short circuit	Check or change the temp. Sensor
Syst2:Antifreeze Sensor1(HSS)	P292	The temp. Sensor is broken or short circuit	Check or change the temp. Sensor
Syst2:Antifreeze Sensor2(HSS)	P296	The temp. Sensor is broken or short circuit	Check or change the temp. Sensor
Syst2:Exhaust Temp Sensor	P281	The temp. Sensor is broken or short circuit	Check or change the temp. Sensor
Syst2:Pressure Sensor fault	PP21	The system 2 pressure Sensor is broken or short circuit	Check or change the pressure Sensor or pressure
Syst2:Inlet Sensor(EVI)	P201	The temp. Sensor is broken or short circuit	Check or change the temp. Sensor
Syst2:Outlet Sensor(EVI)	P202	The temp. Sensor is broken or short circuit	Check or change the temp. Sensor
Syst1:Exhaust Overtemp	P182	The temp. Sensor is broken or short circuit	Check or change the temp. Sensor
Syst2:Exhaust Overtemp	P282	The temp. Sensor is broken or short circuit	Check or change the temp. Sensor
Low AT Protection	TP	The ambient temp. is low	
Fan Motor1 Fault	F031	1. Motor is in locked-rotor state 2.The wire connection between DC-fan motor module and fan motor is in bad contact	1.Change a new fan motor 2.Check the wire connection and make sure they are in good contact
Fan Motor2 Fault	F032	1. Motor is in locked-rotor state 2.The wire connection between DC-fan motor module and fan motor is in bad contact	1.Change a new fan motor 2.Check the wire connection and make sure they are in good contact
Communication Fault (speed control module)	E081	Speed control module and main board communication fail	Check the communication connection

6. Troubleshooting and extra information

Protect/fault	Fault display	Reason	Elimination methods
Communication Fault	E08	Communication failure between wire controller and mainboard	Check the wire connection between remote wire controller and main board
Syst1:Comp Overcurrent	E101	The compressor is overload	Check whether the system of the compressor running normally
Syst2:Comp Overcurrent	E201	The compressor is overload	Check whether the system of the compressor running normally
Syst1: HP Protection	E11	The high-pressure switch is broken	Check the pressure switch and cold circuit
Syst2: HP Protection	E21	The high-pressure switch is broken	Check the pressure switch and cold circuit
Syst1: LP Protection	E12	The high-pressure switch is broken	Check the pressure switch and cold circuit
Syst2: LP Protection	E22	The high-pressure switch is broken	Check the pressure switch and cold circuit
Flow Switch Protection	E032	No water/little water in water system	Check the pipe water flow and water pump
Aux Superheat Protection	E04	The electric-heater protection switch is broken	Check to see whether the electric heater has been running under the temperature over 150°C for a long time
Prim Anti-freezing Prot	E19	The ambient temp. is low	
Secondary Anti-freezing Prot	E29	The ambient temp. is low	
Syst1:Antifreeze(US)	E171	Use side water system temp. is low	1. Check the US water temp. or change the temp. Sensor 2. Check the pipe water flow and whether water system is jammed or not
Syst2:Antifreeze(US)	E271	Use side water system temp. is low	1. Check the US water temp. or change the temp. Sensor 2. Check the pipe water flow and whether water system is jammed or not
Syst1:Antifreeze(HSS)	E172	Heat side water system temp. is low	1. Check the HSS water temp. or change the temp. Sensor 2. Check the pipe water flow and whether water system is jammed or not
Syst2:Antifreeze(HSS)	E272	Heat side water system temp. is low	1. Check the HSS water temp. or change the temp. Sensor 2. Check the pipe water flow and whether water system is jammed or not
Syst1:Exhaust Overtemp	E182	The compressor is overload	Check whether the system of the compressor running normally
Syst2:Exhaust Overtemp	E282	The compressor is overload	Check whether the system of the compressor running normally
Excess Water Temp Diff	E06	Water flow is not enough and low pressure difference	Check the pipe water flow and whether water system is jammed or not

7. The main controller terminals

7.1 The main controller terminals

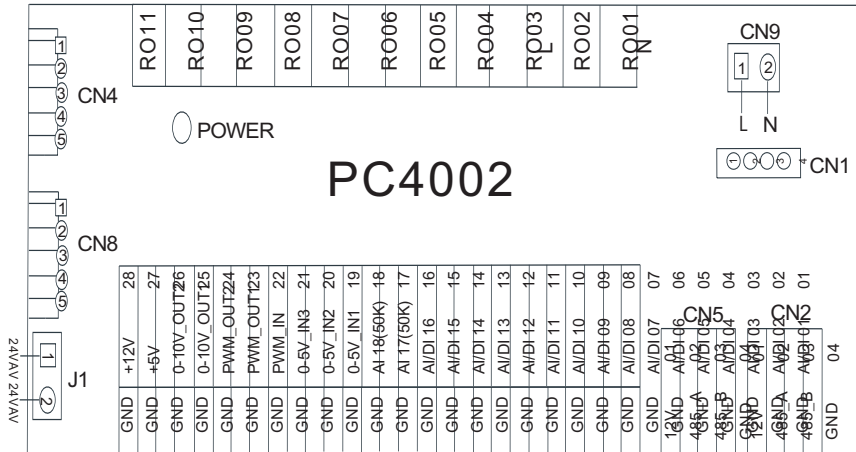

7.2 Connection of PCB illustration

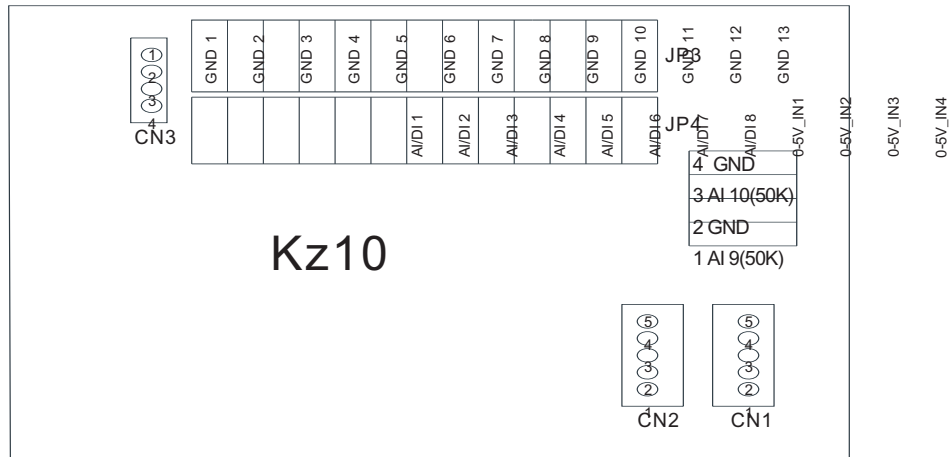

7. The main controller terminals

7.3 Common observation

Look over and clear the failure according to below information.

Failure	Possible causes for the failure	Solutions
Heat pump cannot be started	<ol style="list-style-type: none"> 1 Wrong power supply 2 power supply cable loose 3 circuit breaker open 	<ol style="list-style-type: none"> 1 shut off the power and check power supply; 2 check power cable and make right connection 3 check for the cause and replace the fuse or circuit breaker
Water pump is running with high noise or without water	<ol style="list-style-type: none"> 1 lack of water in the piping 2 much air in the water loop 3 water valves closed 4 dirt and block on the water filter 	<ol style="list-style-type: none"> 1 check the water supply and charge water to the piping; 2 discharge the air in the water loop; 3 open the valves in water loop; 4 clean the water filter.
Heat pump capacity is low, compressor do not stop	<ol style="list-style-type: none"> 1 lack of refrigerant; 2 bad insulation on water pipe; 3 low heat exchange rate on air side exchanger; 4 lack of water flow 	<ol style="list-style-type: none"> 1 check for the gas leakage and recharge the refrigerant; 2 make good insulation on water pipe; 3 clean the air side heat exchanger; 4 clean the water filter
High compressor exhaust	<ol style="list-style-type: none"> 1 too much refrigerant 2 low heat exchange rate on air side exchanger 	<ol style="list-style-type: none"> 1 discharge the redundant gas 2 clean the air side heat exchanger
Low pressure problem of the system	<ol style="list-style-type: none"> 1 lack of gas 2 block on filter or capillary 3 lack of water flow 	<ol style="list-style-type: none"> 1 check the gas leakage and recharge freon; 2 replace filter or capillary; 3 clean the water filter and discharge the air in water loop.
Compressor do not run	<ol style="list-style-type: none"> 1 power supply failure 2 compressor contactor broken 3 power cable loose 4 protection on compressor 5 wrong setting on return water temp. 6 lack of water flow 	<ol style="list-style-type: none"> 1 check off the power supply; 2 replace compressor contactor; 3 tighten the power cable; 4 check the compressor exhaust temp.; 5 reset the return water temp.; 6 clean the water filter and discharge the air in water loop.
High noise of compressor	<ol style="list-style-type: none"> 1 liquid refrigerant goes into compressor 2 compressor failure 	<ol style="list-style-type: none"> 1 bad evaporation, check the cause for bad evaporation and get rid of this; 2 use new compressor;
Fan do not run	<ol style="list-style-type: none"> 1 failure on fan relay 2 fan motor broken 	<ol style="list-style-type: none"> 1 replace the fan relay; 2 replace fan motor.
The compressor runs but heat pump has not heating or cooling capacity	<ol style="list-style-type: none"> 1 no gas in the heat pump; 2 heat exchanger broken; 3 compressor failure. 	<ol style="list-style-type: none"> 1 check system leakage and recharge refrigerant; 2 find out the cause and replace the heat exchanger; 3 replace compressor.
Low outlet water temperature	<ol style="list-style-type: none"> 1 low water flow rate; 2 low setting for the desired water temp.; 	<ol style="list-style-type: none"> 1 clean the water filter and discharge the air in water loop. 2 reset the desired water temperature.
Low water flow protection	<ol style="list-style-type: none"> 1 lack of water in the system; 2 failure on flow switch 	<ol style="list-style-type: none"> 1 clean the water filter and discharge the air in water loop. 2 replace the flow switch.

8. Appendix

8.1 Caution & Warning

- 1 The unit can only be repaired by qualified installer centre personnel or an authorised dealer. (for Europe market)
- 2 This appliance is not intended for use by persons (including children) with reduced physical sensory or mental capabilities, or lack of experience and knowledge, unless they have been given supervision or instruction concerning use of the appliance by a person responsible for their safety. (for Europe market)
Children should be supervised to ensure that they do not play with the appliance.
- 3 Please make sure that the unit and power connection have good earthing, otherwise may cause electrical shock.
- 4 If the supply cord is damaged, it must be replaced by the manufacturer or our service agent or similarly qualified person in order to avoid a hazard.
- 5 Directive 2002/96/EC (WEEE):
The symbol depicting a crossed-out waste bin that is underneath the appliance indicates that this product, at the end of its useful life, must be handled separately from domestic waste, must be taken to a recycling centre for electric and electronic devices or handed back to the dealer when purchasing an equivalent appliance.
- 6 Directive 2002/95/EC (RoHs): This product is compliant with directive 2002/95/EC (RoHs) concerning restrictions for the use of harmful substances in electric and electronic devices.
- 7 The unit CANNOT be installed near the flammable gas. Once there is any leakage of the gas, fire can be occur.
- 8 Make sure that there is circuit breaker for the unit, lack of circuit breaker can lead to electrical shock or fire.
- 9 The heat pump located inside the unit is equipped with an over-load protection system. It does not allow for the unit to start for at least 3 minutes from a previous stoppage.
- 10 The unit can only be repaired by the qualified personnel of an installer center or an authorized dealer. (for North America market)
- 12 Installation must be performed in accordance with the NEC/CEC by authorized person only. (for North America market)
- 13 USE SUPPLY WIRES SUITABLE FOR 75°C.
- 14 Caution: Single wall heat exchanger, not suitable for potable water connection.

8. Appendix

8.2 Cables specification

1 Single phase unit

Nameplate maximum current	Phase line	Earth line	MCB	Creepage protector	Signal line
No more than 10A	2×1.5mm ²	1.5mm ²	20A	30mA less than 0.1 sec	n×0.5mm ²
10~16A	2×2.5mm ²	2.5mm ²	32A	30mA less than 0.1 sec	
16~25A	2×4mm ²	4mm ²	40A	30mA less than 0.1 sec	
25~32A	2×6mm ²	6mm ²	40A	30mA less than 0.1 sec	
32~40A	2×10mm ²	10mm ²	63A	30mA less than 0.1 sec	
40~63A	2×16mm ²	16mm ²	80A	30mA less than 0.1 sec	
63~75A	2×25mm ²	25mm ²	100A	30mA less than 0.1 sec	
75~101A	2×25mm ²	25mm ²	125A	30mA less than 0.1 sec	
101~123A	2×35mm ²	35mm ²	160A	30mA less than 0.1 sec	
123~148A	2×50mm ²	50mm ²	225A	30mA less than 0.1 sec	
148~186A	2×70mm ²	70mm ²	250A	30mA less than 0.1 sec	
186~224A	2×95mm ²	95mm ²	280A	30mA less than 0.1 sec	

2 Three phase unit

Nameplate maximum current	Phase line	Earth line	MCB	Creepage protector	Signal line
No more than 10A	3×1.5mm ²	1.5mm ²	20A	30mA less than 0.1 sec	n×0.5mm ²
10~16A	3×2.5mm ²	2.5mm ²	32A	30mA less than 0.1 sec	
16~25A	3×4mm ²	4mm ²	40A	30mA less than 0.1 sec	
25~32A	3×6mm ²	6mm ²	40A	30mA less than 0.1 sec	
32~40A	3×10mm ²	10mm ²	63A	30mA less than 0.1 sec	
40~63A	3×16mm ²	16mm ²	80A	30mA less than 0.1 sec	
63~75A	3×25mm ²	25mm ²	100A	30mA less than 0.1 sec	
75~101A	3×25mm ²	25mm ²	125A	30mA less than 0.1 sec	
101~123A	3×35mm ²	35mm ²	160A	30mA less than 0.1 sec	
123~148A	3×50mm ²	50mm ²	225A	30mA less than 0.1 sec	
148~186A	3×70mm ²	70mm ²	250A	30mA less than 0.1 sec	
186~224A	3×95mm ²	95mm ²	280A	30mA less than 0.1 sec	

When the unit will be installed at outdoor, please use the cable which can against UV.



Code:20170321-0001