

SWIMMING POOL DEHUMIDIFIER

Installation & Operation Manual

CONTENT

1. Preface	1
2. Installation Precautions	2
2.1 Marks	2
2.2 Icons	2
2.3 Warnings	2
2.4 Attention	3
3. Specifications	4
3.1 Parameters	4
3.2 Performance Curve	5
3.3 Dimensions	6
3.4 Working Principle	6
3.5 Product Features	7
3.6 Hygrostat Control	7
4. Installation	8
4.1 Installation Precautions	8
4.2 Positioning	8
4.3 Minimum Installation Distances	8
4.4 Drainage	10
5. Operation and Usage	11
5.1. The wire controller operation interface	11
5.2. Function of wire controller	12
5.3. Controller interface diagram and definition	15
6. Maintenance	16
6.1 Maintenance	16
6.2 Troubleshootings	17

1. Preface

Thank you for choosing Swimming Pool Dehumidifier for controlling the climate in you pool area. This product strictly complies with design and production standards to provide perfect performance, high reliability and good adaptability for you.

Read the entire manual before the initial start-up of the unit. It is important to know the correct operating procedures for the unit and all safety precautions to prevent the possibility of property damage and/or personal injury. Do not modify or intervene on the unit by yourself only as this could create dangerous situations and the manufacturer will not be responsible for any damage caused.

This instruction must be kept carefully and must always accompany the appliance. If it is lost or damaged, please contact the local technical service center.

1.1 Fail to comply with these recommendations will invalidate the warranty.



- This unit must be installed by an authorized installer.
- All repair or maintenance interventions must be performed by the technical service department or by professionally qualified personnel.
- All repair or maintenance interventions must be performed in the specified period and times.
- Use the spare parts ONLY provided by the manufacturer.

1.2 In case of system leakage, disconnect the power to the unit and call the technical service department or other professionally qualified personnel as soon as possible, and do not intervene personally on the appliance.

If the unit is not used for a long time, you should disconnect the power to the unit.

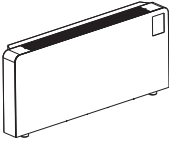
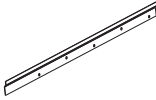

1.3 Packing List (Fig.1)

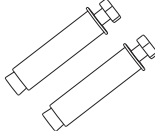
Fig.1



Main unit	Wall suspension bar	Manual	Expansion bolts
			

2. Installation Precautions



2.1 Marks



Mark	Meaning
 WARNING	A wrong operation may lead to death or heavy injury on people.
 ATTENTION	A wrong operation may lead to harm to people or loss of property.



2.2 Icons

Icon	Meaning
	Prohibition. What is prohibited will be nearby this icon.
	Compulsory implement. The listed actions need to be taken.
	Attention(include warnings) Please pay attention to what is indicated.

2.3 Warnings



INSTALLATION	 PROFESSIONAL INSTALLER IS REQUIRED	Entrust a specialized personnel for installation. Wrong installation may cause leakage, personnel electric shock or fires.
	 EARTHING IS REQUIRED	Confirm whether wether the unit is with correct earthing. Wrong connection may cause personnel shock.



OPERATION	 PROHIBITION	Do not put fingers or others into the fan or evaporator of the unit, otherwise harm may be occurred.
	 SHUT OFF THE POWER	When there is something wrong or strange smell from the unit, please cut off the power to the unit immediately.

MOVE AND REPAIR	 ENTRUST	When the unit needs to be moved or installed again, please entrust dealer or qualified person to carry it out. Improper installation may lead to water leakage, electrical shock, injury or fire.
	 PROHIBIT	It is prohibited to repair the unit by the user himself, otherwise electrical shock or fire may occur.
	 ENTRUST	When the unit needs to be repaired, please entrust dealer or qualified person to carry it out. Improper movement or repair on the unit may lead to water leakage, electrical shock, injury or fire.

2. Installation Precautions

2.4 Attention

INSTALLATION	Meaning
 Fix the unit	Make sure that the basement of the unit is strong enough to avoid any decline or fall down.
 Need circuit breaker	Make sure that there is circuit breaker for the unit. Lack of circuit breaker can lead to electrical shock or fire.

OPERATION	Meaning
 Check the installation basement	Please check the installation basement regularly to avoid any decline or damage which may hurt people or damage the unit.
 Disconnect the power	Please disconnect the power to the unit for clean or maintenance.
 Prohibit	Please use the suitable fuse. If copper or iron is used to replace the fuse, it will cause failure, even fire.



Warning:

Remember that some fundamental safety rules should be followed when using this product:

1. This appliance is not intended for use by persons (including children) with reduced physical, sensory or mental capabilities, or lack of experience and knowledge, unless they have been given supervision or instruction concerning use of the appliance by a person responsible for their safety. Children should be supervised to ensure that they do not play with the appliance.
2. It is forbidden to touch the appliance with wet hands or body when barefoot.
3. It is forbidden to carry out any cleaning before having disconnected the appliances from the electricity mains supply by turning the system master switch to OFF.
4. It is forbidden to modify the safety or adjustment devices or adjust without authorization and indication of the manufacturer.
5. It is forbidden to pull, cut or knot the electrical cables coming out of the appliance, even if it is disconnected from the mains supply.
6. If the supply cord is damaged, it must be replaced by the manufacturer, its service agent or similarly qualified persons in order to avoid a hazard.
7. It is forbidden to poke objects or anything else through the inlet or outlet grills.
8. It is forbidden to dispose of or leave in the reach of children the packaging materials which could become a source of danger.
9. It is forbidden to climb onto the appliance or rest any object on it.
10. It is forbidden to touch the unit with hands directly as the external parts of the appliance can reach temperatures of more than 70°C.
11. The appliance shall be installed in accordance with national wiring regulations.

3. Specifications

3.1 Parameters

● Swimming Pool Dehumidifier

Model	Unit	PCF-2.2BD	PCF-3.0BD	PCF-4.3BD
Rated Capacity	L/h	2.2	3.0	4.3
Dehumidification capacity per day	L	53	72	103
Max pool area	m ²	42	60	83
Noise Level	dB(A)	47	48	48
Rated Voltage/Freq	/	220-240V~/50Hz		
Rated Power Input	kW	0.93	1.33	1.97
Rated Running Current	A	4.1	6.1	8.7
Max.Power Input	kW	1.02	1.55	2.28
Max.Running Current	A	4.3	7.14	10
Relative Humidity	%RH	40~90	40~90	40~90
Temperature	°C	10~36		
Dimensions(L/W/H)	mm	See 3.3		
Net Weight	kg	See nameplate/ package label		
Refrigerant	/	R410A		
Condensation Pipe Diameter	mm	16	16	16

Test condition: Ambient temperature: 30°C, Relative humidity: 80%.

Operating limits: temperature 10°C~36°C
relative humidity 40%~90%

3. Specifications

3.2 Performance Curve

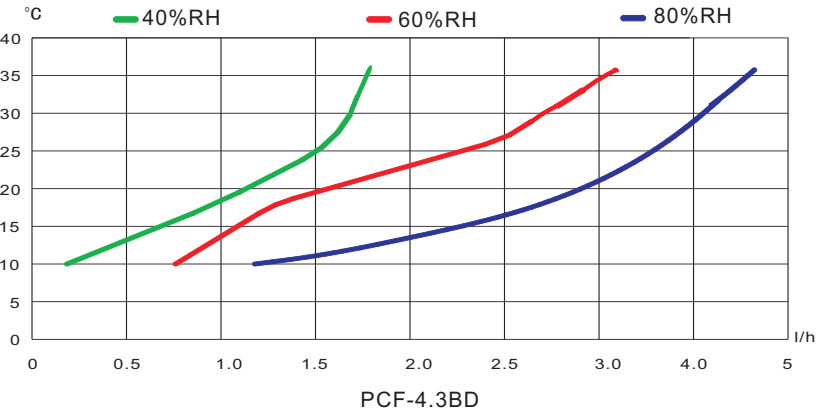
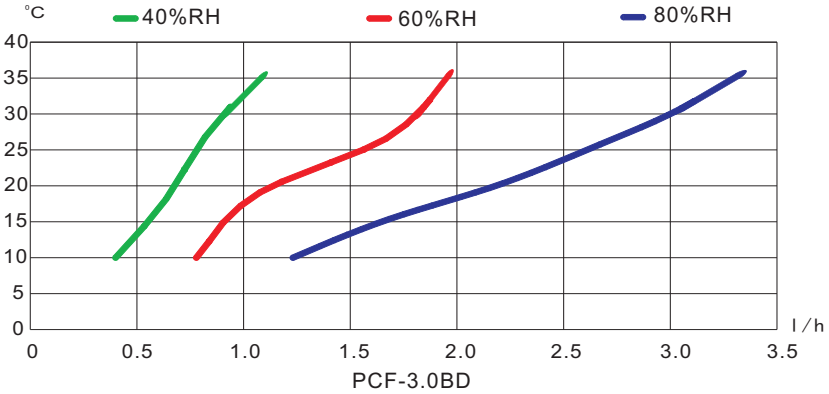
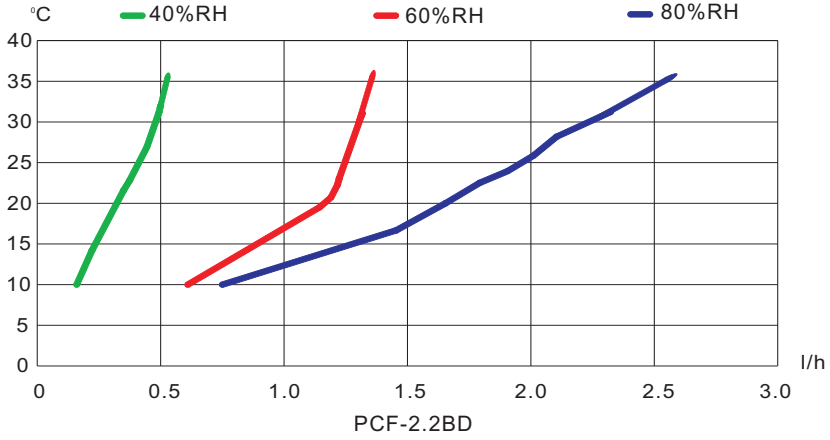

3. Specifications

3.3 Dimensions

3.3.1 Applicable product model:PCF-2.2/3.0/4.3BD

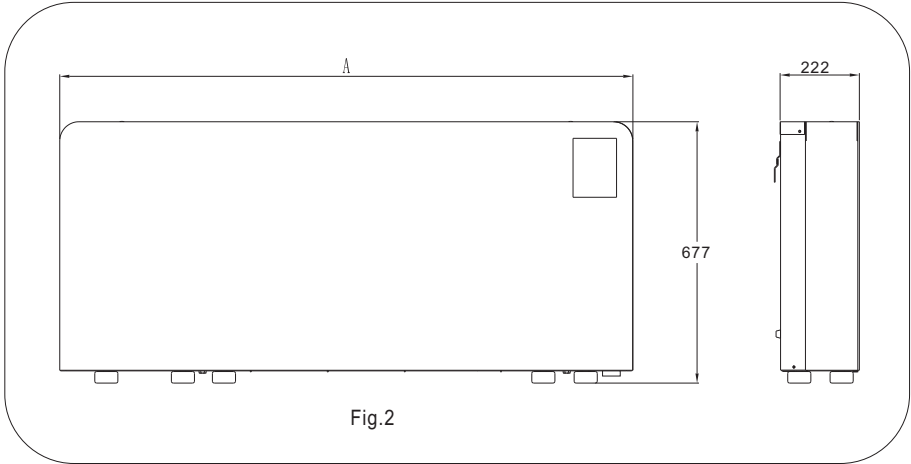

Model	PCF-2.2BD	PCF-3.0BD	PCF-4.3BD
Length: A	1295	1495	1495

3.4 Working Principle:

The unit works by drawing moist air over a refrigerated coil with a small fan. The cold coil of the refrigeration device condenses the water, which is removed, then the air is reheated by the hot coil. This process works most effectively with higher ambient temperatures with a high dew point temperature(Fig.3).

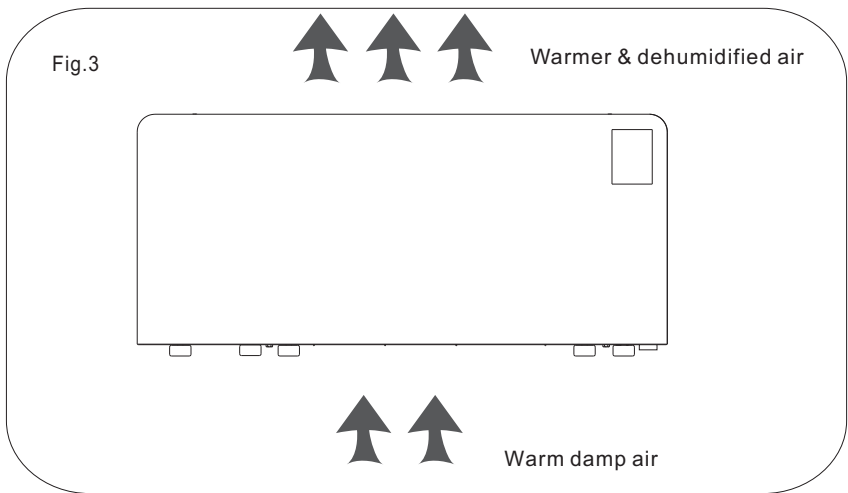

3. Specifications

3.5 Product Features

3.5.1 Ultra-low noise

With the advanced air ducting technology and the super quiet cross-flow fan, the unit can operate with ultra-low noise.

3.5.2 Ultra-thin casing

With the ultra-thin casing of 200mm, which is the result of compact design, the unit can save more space for you when it is compared with the common dehumidifiers with the thickness of 400mm.

3.5.3 Fashionable appearance

With noble & fashion arc frame and elegant & graceful snow white color, the unit will be perfectly combined with your pool house.

3.5.4 Newly design controller.

With simple operating display, the newly developed controller makes the unit operation easier and more user-friendly.

3.6 Hygrostat Control

3.6.1 The dehumidifier is controlled by a built-in hygrostat set on one side of the unit and the target RH value can be set ranges from 30% to 90%.

3.6.2 The unit will not start to dehumidify until the actual RH is beyond the setting value.

3.6.3 We recommend that an external hygrostat should be installed to ensure a constant measure of the humidity in the pool area.

3.6.4 The location of hygrostat is as the following (Fig.4):

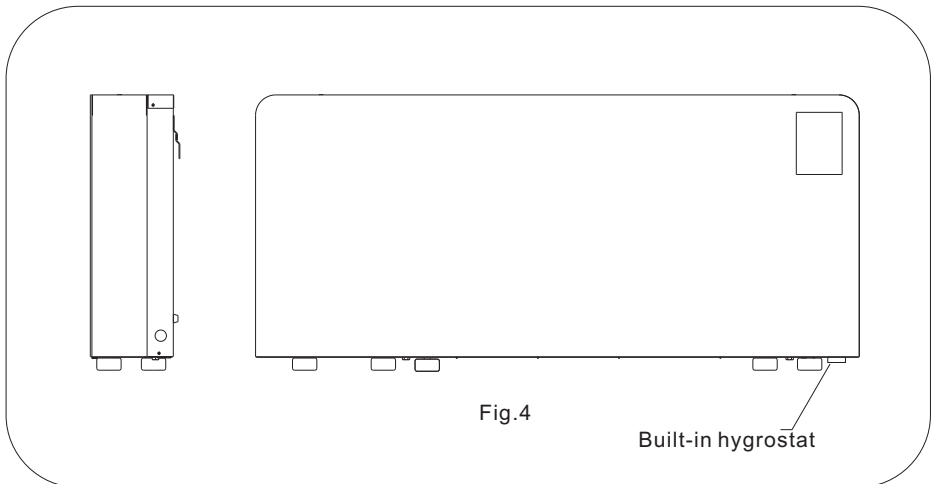

4. Installation

4.1 Installation Precautions

4.1.1 To ensure that the installation is performed correctly and that the appliance will perform perfectly, please carefully follow the instructions indicated in this manual. Fail to respect the rules indicated not only can cause malfunctions of the appliance but also invalidate the warranty, hence our company shall not respond for any damage to persons, animals or property.

4.1.2 It is important that the electrical installation is made according to the laws in force, respects the data indicated in the technical sheet and the unit is correctly earthed.

4.1.3 The appliance must be installed in a position that allows the routine maintenance, such as filter cleaning.

4.2 Positioning

4.2.1 Avoid installing the unit in proximity to:

- positions subject to exposure to direct sunlight;
- sources of heat;
- in places with oil fumes
- places subject to high frequencies.

4.2.2 Make sure that:

- the wall on which the unit is to be installed is strong enough to support the weight;
- the part of the installation wall does not have pipes or electric wires passing through;
- the installation wall is perfectly flat;
- there is an area free of obstacles which could interfere with the inlet and outlet air flow;
- it is preferably that there is an outside perimeter-wall to allow the discharge of condensation outside;

4.3 Minimum Installation Distances

4.3.1 Removing the four rubber feet of the unit are suggested if hanging it on the wall.

4.3.2 Fig. 5 indicates the minimum mounting distances between the wall-mounted swimming pool dehumidifier and furniture in the room.

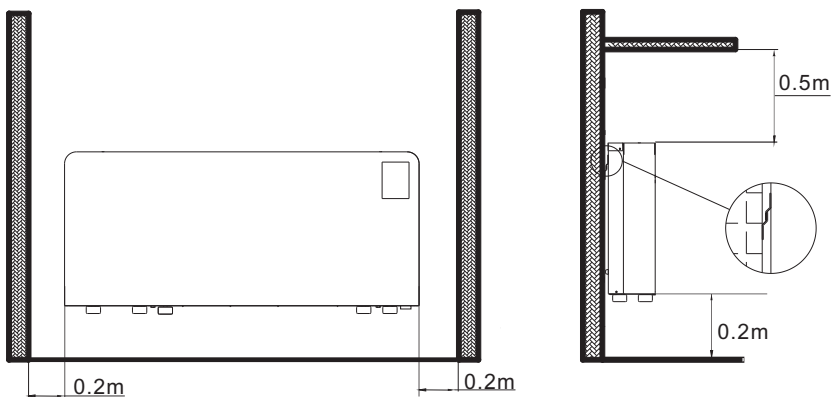

Fig.5

4. Installation

4.3.3 Wall mounted installation

Insert 5 expansion bolts into holes which are bored by $\phi 10$ drill and fix the wall suspension bar horizontally(Fig.6).

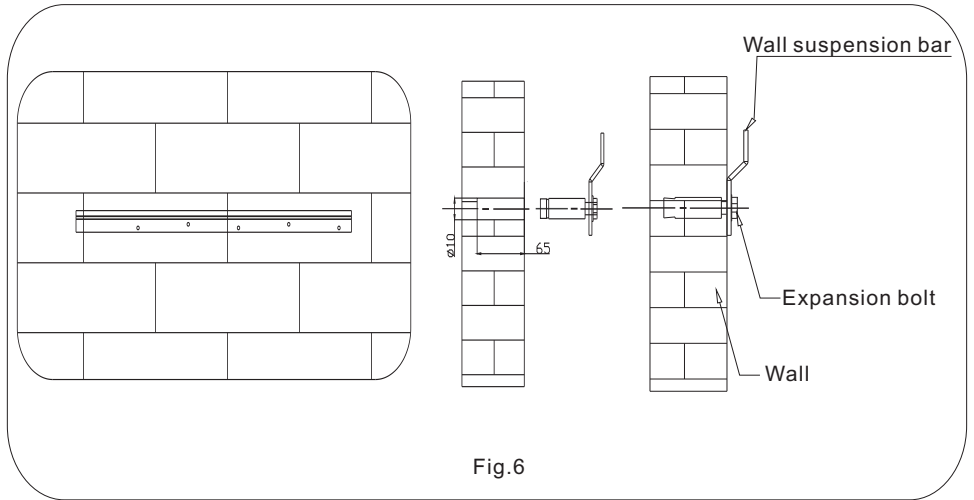

Fig.6

4.4 Drainage

Select a suitable size hose to connect to the built-in hose if it is needed(Fig.7).

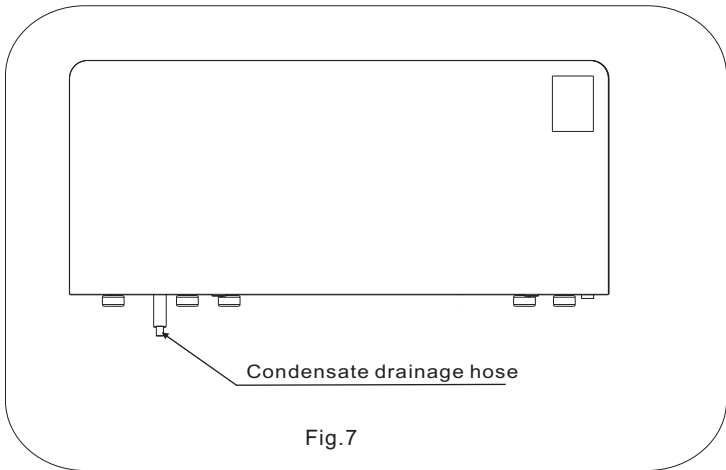

Fig.7

 Attention :

- If the condensation water discharges directly into a container, the condensate outlet should be above the container to avoid immersing in the container.

5. Operation and Usage

5.1. The wire controller operation interface

5.1.1 Full display interface

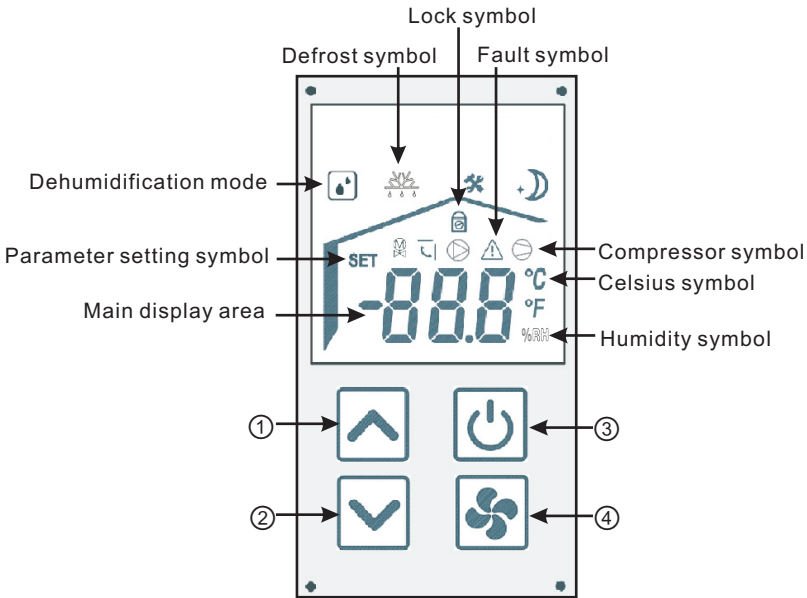

5.1.2 Key description

Key number	Key name	Key function
①	Up	Press this key to select the upward option or increase the parameter value.
②	Down	Press this key to select the downward option or decrease the parameter value.
③	ON/OFF	Press this button to turn on/off and cancel the current operation and return to the previous menu
④	Wind speed button	Press to set the wind speed and confirm/save Parameters

5.Operation and Usage

5.2. Function of wire controller

5.2.1 ON and OFF

Off state: press the On/Off key, the unit enters the On state; key lights and display lights are up.

On state: press the On/Off key, the unit enters the Off state; key lights and display lights are off .

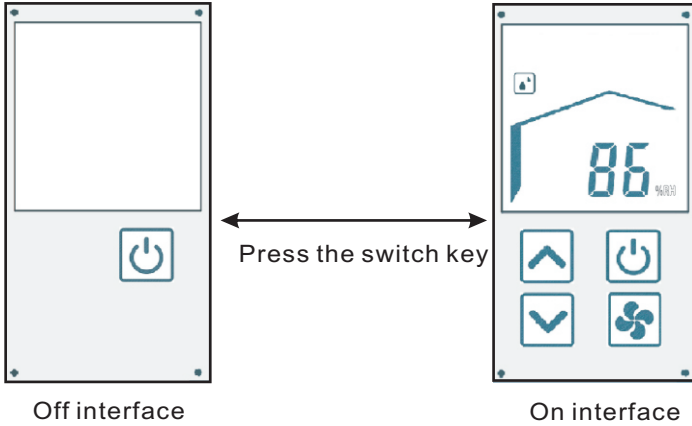

5.2.2 Target humidity setting

In the ON interface, short press the up or down key after the target humidity flashing, Press the up or down key to change the target humidity value.

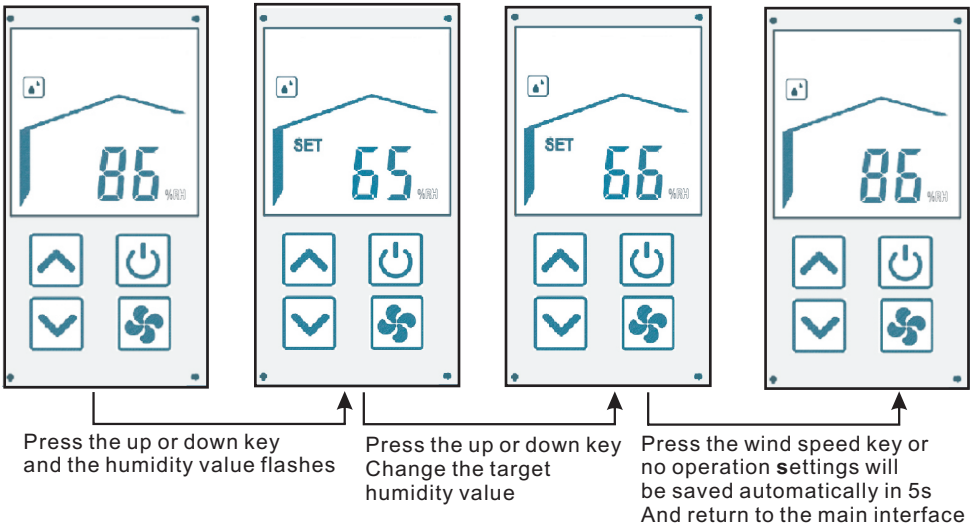

5.Operation and Usage

5.2.3 wind speed setting

In the main interface short press the wind speed button to enter the wind speed setting, wind speed level value flashing, Short press the wind speed key, wind speed cycles between 1-3, if no operation in 5s, settings will be saved automatically and return to the main interface.

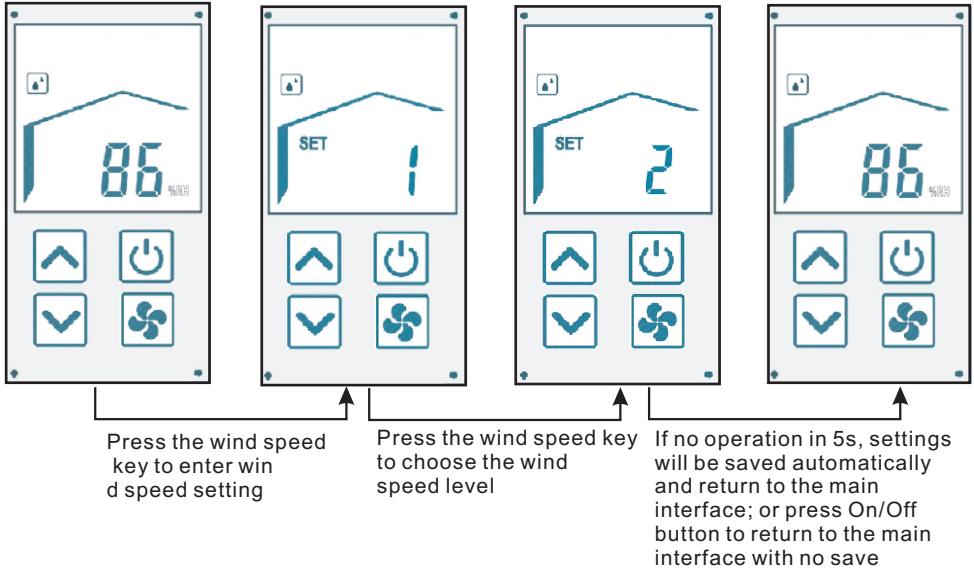

5.2.4 keyboard lock function

To avoid any faulty operations by others, please lock the keyboard after finishing settings. In the main interface, long press On/Off button for 5 seconds, you can lock the keyboard; in the keyboard lock state, long press On/Off button for 5 seconds, you can unlock the keyboard. In the lock keyboard interface you can only unlock, other operations are invalid.

5.Operation and Usage

5.2.5 fault interface

When the unit fails, the fault code displays in the main display area, press the up or down button, faults will display in cycle. Press the On button to return to the main interface.

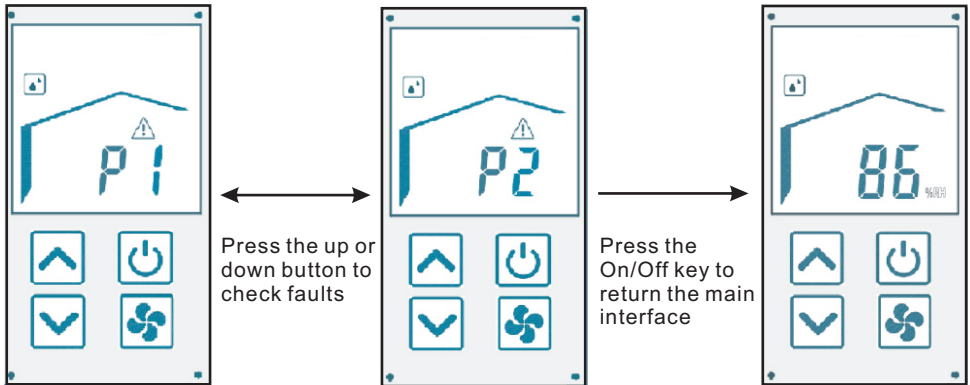

5.2.6 Malfunction table

You could determine or remove failures according to the following malfunction table:

Malfunction	Code	Reason	Solution
High pressure protection 3 times and above	P1	High pressure switch off 3 times and above	Check the pressure switch and the cooling circuit
High pressure protection	P2	High pressure switch off	Check the pressure switch and the cooling circuit
Exhaust overtemperature Protection	P3	Compressor overload	Check that the system compressor operation
Exhaust overtemperature protection 3 times and above	P4	Compressor overload 3 times and above	Check that the system compressor operation
Air return temperature sensing fault	P5	Air return temp. Sensing head open or short circuit	Check and replace the return air temperature head
Coil temperature sensing fault	P6	Coil temperature sensing head open or short circuit	Check and replace coil temperature head
Exhaust temperature sensing fault	P7	Exhaust temperature sensing head open or short circuit	Check and replace the exhaust temperature head
Humidity sensing fault	P8	Humidity sensing open or short circuit	Check and replace the humidity sensor
Fan feedback signal fault	E0	Fan feedback signal open or short circuit	Check the fan feedback signal
Communication fault	E8	Remote controller and main board communication error	Check remote controller and main board/wiring
Ambient temp.Sensor failure	P9	Ambient sensor open or short circuit	Check and replace the ambient sensor
Ambient overtemperature or too cold protection	P0	Ambient temperature overheat or too cold	

5.Operation and Usage

5.3. Controller interface diagram and definition

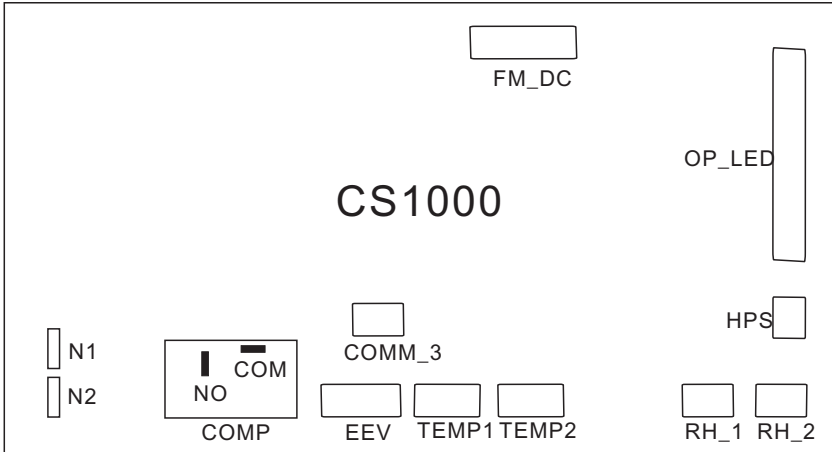

The input and output interfaces of the mainboard are described below.

Number	Symbol	The definition of the ports
01	N1	Power supply zero line
02	N2	Compressor zero line
03	COM	Power line
04	NO	Compressor output port
05	FM_DC	Fan output
06	COMM_3	Wire communication
07	OP_LED	No use
08	HPS	High pressure protection
09	EEV	Electronic expansion valve
10	TEMP1	Return air temperature / coil temperature
11	TEMP2	Exhaust temperature/Ambient temperature
12	RH_1	No use
13	RH_2	Humidity detection

6. Maintenance

6.1 Maintenance

- To guarantee the unit reliable and security operation for a long time, it is suggested to maintain and clean up the unit every six months.
- Please take the following steps to clean up the strainer regularly:
 - 1) Press the two red buttons and drag it down slowly (Fig.8) ;
 - 2) Separate the return air filter screen from the units as the image shown below (Fig.9) ;
 - 3) Take away the return air filter screen and flush it with water (Fig.10) .

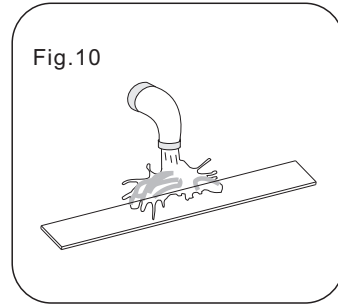
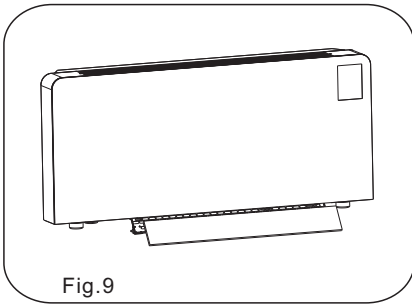
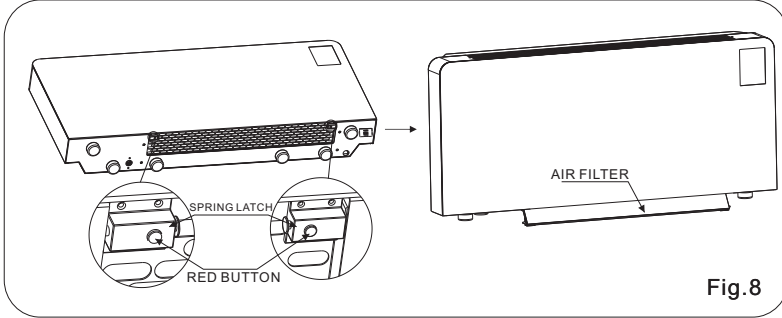

- 4) Set the filter net and the air return grille to the original place and press the limiting pin. (Fig.11).
- 5) Clean up the unit outer with soft and damp rag (Fig.12) . To protect the paint-coat of the unit, please don' t use rough sponge or corrosive detergent to do these.

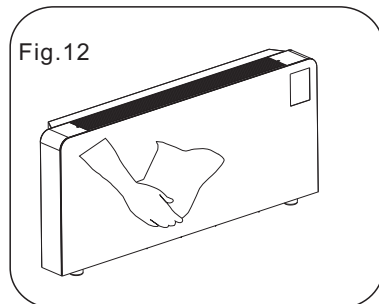
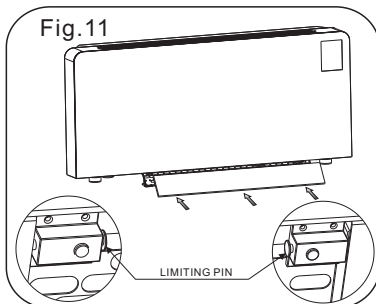

Warning : Cut off power supply before cleaning or maintaining the unit.

6. Maintenance

6.2 Trouble shooting

Press the key of "UP" or "Down" to check that if there are more failure codes.
You can find solutions to the problems according to the codes.

Malfunction	Code	Reason	Solution
High pressure protection has appeared 3 times in 30mins.	P1	High pressure protection is too frequently.	Check the below solutions to failure P1/P2/P3
High pressure protection	P2	Discharge pressure is too high	
Condenser outlet temp. overhigh	P3	Condenser coil temp. is too high	
Evaporator outlet temp. sensor failure	P5	This temp. sensor is broken or in open/short circuit	Check or replace this temp. sensor
Evaporator inlet temp. sensor failure	P6	This temp. sensor is broken or in open/short circuit	Check or replace this temp. sensor
Condenser outlet temp. sensor failure	P7	This temp. sensor is broken or in open/short circuit	Check or replace this temp. sensor
Humidity sensor failure	P8	Humidity sensor is broken or in open/short circuit	Check or replace this humidity sensor
Motor feedback signal failure	E0	The feedback wiring is in bad connection. Or fan motor is damaged.	1.Check the feedback wiring of fan motor. 2.Or replace the fan motor.

Solution to failure P1/P2/P3:

1. If P1/P2/P3 appears together with other failures, please solve the others first.
2. If there is no other failures of P3~E0, and P1 & P2 still exist, please disconnect the power to the unit and connect again after 1 hour.
3. If only P3 exists, please keep the fan running for 30min. If P3 still exist after the running, please disconnect the power to the unit and connect again after 1 hour.

Note: Please contact with Technical Service Assistance when failures can not be solved.

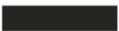

Code: 20170309-0001