

ART. COD. 1111 (2000 W)

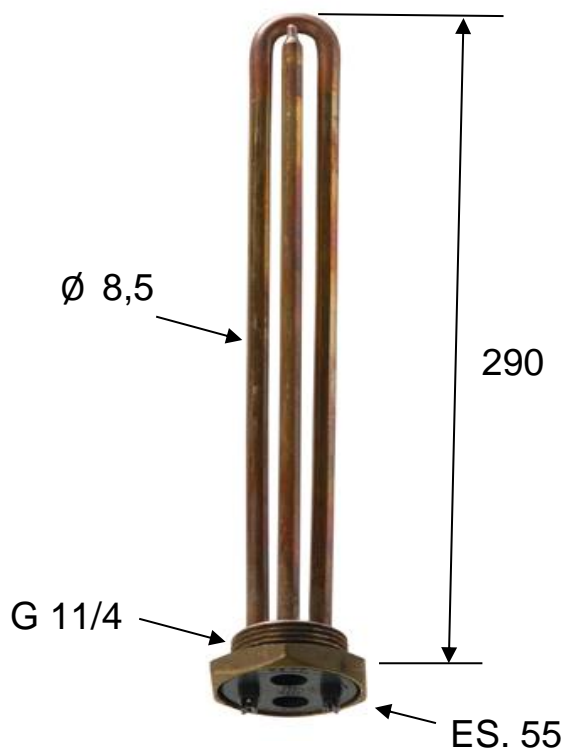

RESISTENZA DIRITTA
STRAIGHT HEATING ELEMENT

POTENZA / POWER 2000 W
VOLT 220

MATERIALI / MATERIALS
OTTONE /BRASS - RAME / COPPER