

General information

Elbow EPP 125 90°

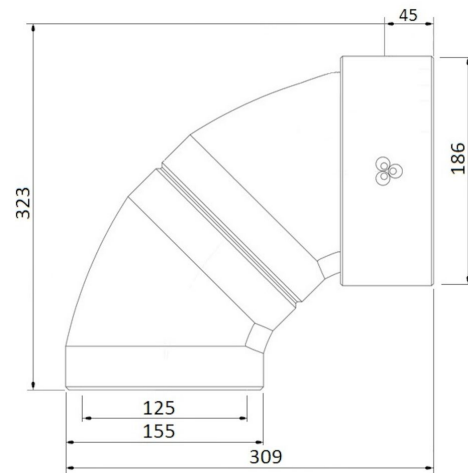

Specifications

Article number	400480484
Product category	Insulated tube
Material	EPP
Colour	Gray
Wall Thickness (mm)	15
Weight (kg)	0,14

Dimensions

Diameter inside (mm)	125
Diameter outside (mm)	155
Dimensions (l x w x h mm)	323 x 186 x 309

Application Insights

Application	Ventilation
Supply / Extract	Supply/Extract
Temperature range (°C)	-25 / +80

Technical Specifications

Maximum air flow (m ³ /h)	275
ζ extract	0,21
ζ supply	0,21
Air tightness class (ATC)	3
Thermal resistance (W/mK)	0,037
R-value (m ² K/W)	0,41
Fire rating EN 13501-1	E
Other specifications	-

Graph

Pressure loss

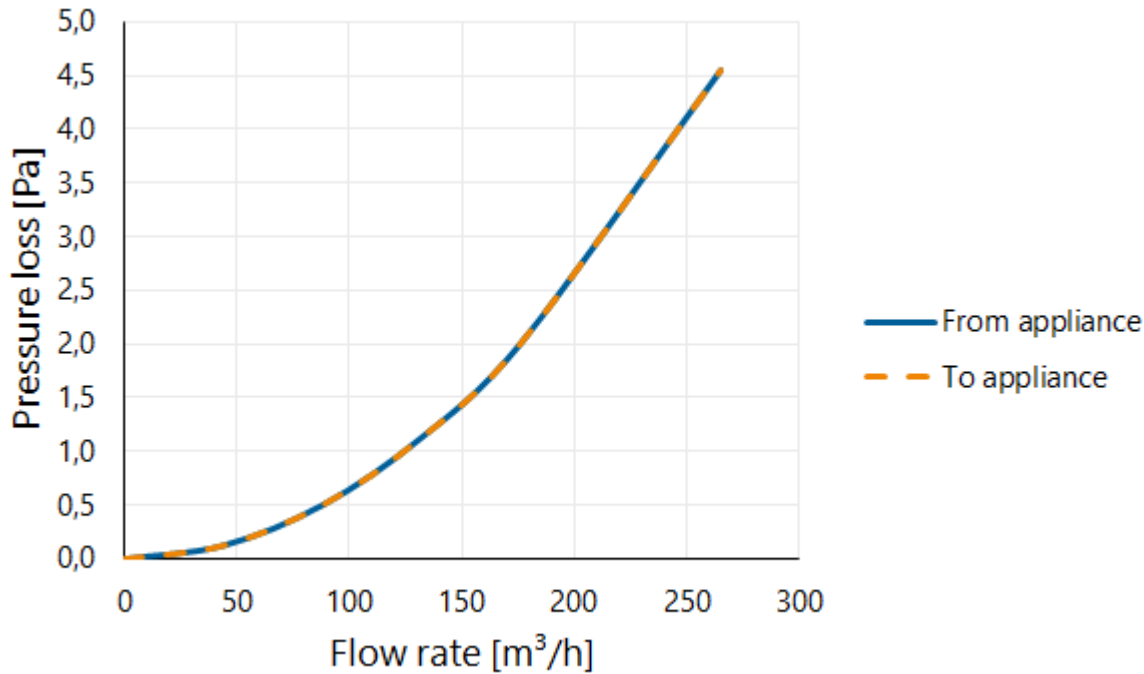

Table

Flow velocity pressure table

Flow rate			Static pressure loss	
[m/s]	[m³/h]	[l/s]	From appliance [Pa]	To appliance [Pa]
0	0	0	0,0	0,0
1	44	12	0,1	0,1
2	88	25	0,5	0,5
3	133	37	1,1	1,1
4	177	49	2,0	2,0
6	265	74	4,5	4,5