

General information

Elbow EPP 150 45°

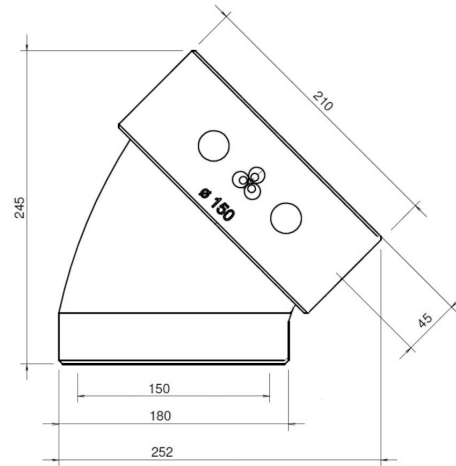

Specifications

Article number	400480476
Product category	Insulated tube
Material	EPP
Colour	Gray
Wall Thickness (mm)	15
Weight (kg)	0,12

Dimensions

Diameter inside (mm)	150
Diameter outside (mm)	180
Dimensions (l x w x h mm)	252 x 210 x 245

Application Insights

Application	Ventilation
Supply / Extract	Supply/Extract
Temperature range (°C)	-25 / +80

Technical Specifications

Maximum air flow (m ³ /h)	375
ζ extract	0,10
ζ supply	0,10
Air tightness class (ATC)	3
Thermal resistance (W/mK)	0,037
R-value (m ² K/W)	0,41
Fire rating EN 13501-1	E
Other specifications	-

Graph

Pressure loss

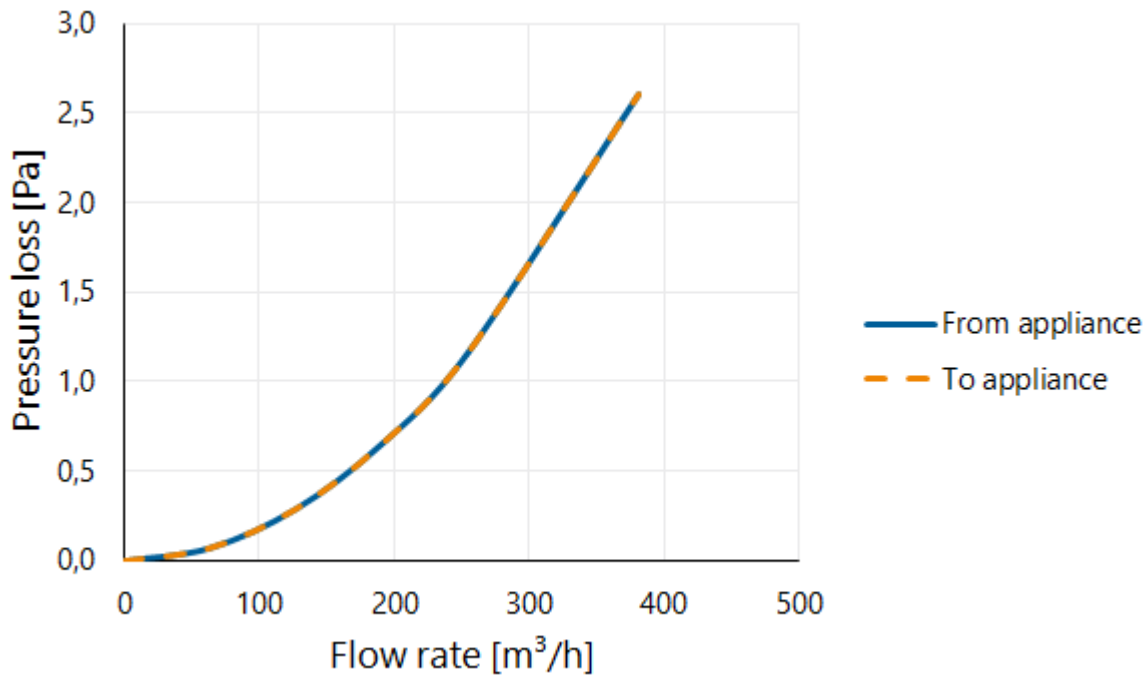

Table

Flow velocity pressure table

Flow rate			Static pressure loss	
[m/s]	[m³/h]	[l/s]	From appliance [Pa]	To appliance [Pa]
0	0	0	0,0	0,0
1	64	18	0,1	0,1
2	127	35	0,3	0,3
3	191	53	0,7	0,7
4	254	71	1,2	1,2
6	382	106	2,6	2,6