



# Installation Instruction for Rigid & Flexible Coupling



1. Pipe Preparation

Check pipe end for proper groove dimensions and to assure that pipe end is free of indentations and projections that would prevent proper sealing.



2. Lubricate Gasket

Check gasket to be sure it's compatible for the intended service. Apply thin lubricant to the outside and sealing lips of the gasket.



3. Gasket Installation

Slip the gasket over one pipe, making sure the gasket lip does not over-hang the pipe end.



4. Alignment

After aligning two pipe ends together, pull the gasket into position, centering between the grooves on each pipe. The gasket should not extend into the groove on either pipe.



5. Housing Installation

Remove one bolt&nut and loosen the other nut. Place one housing over the gasket, making sure the housing keys fit into the pipe grooves. Swing the other housing over the gasket and into the grooves on both pipes. Re-insert the bolt and connect two housings.



6. Tighten Nuts

Check gasket to be sure it's compatible for the intended service. Apply thin lubricant to the outside and sealing lips of the gasket.



7 a. Assembly completed- Rigid Coupling

Slip the gasket over one pipe, making sure the gasket lip does not over-hang the pipe end.



7 b. Assembly Completed Flexible Coupling

After aligning two pipe ends together, pull the gasket into position, centering between the grooves on each pipe. The gasket should not extend into the groove on either pipe.

## Caution

Proper torquing of bolts is required to obtain specified performance.

- Over torquing the bolts may result in damage to the bolt and / or casting which could result in pipe joint separation.
- Under torquing the bolts may result in lower pressure retention capabilities, lower bend load capabilities, joint leakage and pipe joint separation. Pipe joint separation may result in significant property damage and serious injury.

## Specified Bolt Torque ANSI BOLTS

Bolt Size Inch	Specified Bolt Torque	
	Lbs-Ft.	N.m
3/8	30-45	40-60
1/2	80-100	110-135
5/8	100-130	135-175
3/4	130-180	175-245
7/8	180-240	245-325



# Installation Instruction for Threaded & Grooved Mechanical Tee



1. Pipe Preparation

Clean the gasket sealing surface within 16mm of the hole and visually inspect the sealing surface for defects that may prevent proper sealing of the gasket. Don't drill the hole on weld line.



2. Remove Burrs

If any burrs or slug exists at the pipe hole, please remove them before assembly, to protect the gasket and avoid leakage.



3. Gasket installation

Insert the gasket into outlet housing making sure the tab in the gasket line up with the tab recesses in the housing. Align outlet housing over the pipe hole making sure that the locating collar is in the pipe hole.



4. Alignment

Align the strap around the pipe, insert the bolts and tighten the nuts finger tight.

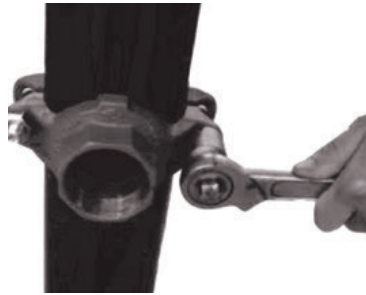

5. Tighten Nuts

Alternatively and evenly tighten the nuts to the specified bolt torque.



6. Assembly completed

There should be even gaps on two sides between upper and lower housings.

## Caution

Proper torquing of bolts is required to obtain specified performance.

- Over torquing the bolts may result in damage to the bolt and / or casting which could result in pipe joint separation.
- Under torquing the bolts may result in lower pressure retention capabilities, lower bend load capabilities, joint leakage and pipe joint separation. Pipe joint separation may result in significant property damage and serious injury.

## Specified Bolt Torque ANSI BOLTS

Bolt Size Inch	Specified Bolt Torque	
	Lbs-Ft.	N.m
3/8	30-45	40-60
1/2	80-100	110-135
5/8	100-130	135-175
3/4	-	-
7/8	-	-



1. Pipe Preparation

Clean the gasket sealing surface within 16mm of the hole and visually inspect the sealing surface for defects that may prevent proper sealing of the gasket. Don't drill the hole on weld line.



2. Remove Burrs

If any burrs or slug exists at the pipe hole, please remove them before assembly, to protect the gasket and avoid leakage.



3. Gasket Installation

Insert the gasket into outlet housing properly. Align outlet housing over the pipe hole making sure that the locating collar is in the pipe hole.



4. Alignment

Attach the U-bolt from the other side and tighten the nuts finger tight.



5. Tighten Nuts

Alternatively and evenly tighten the nuts to the specified bolt torque.

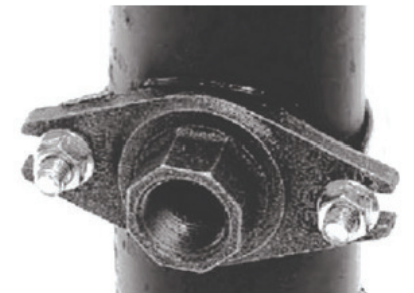

6. Assembly Completed

Assembly completed.

### Caution

Proper torquing of bolts is required to obtain specified performance.

- Over torquing the bolts may result in damage to the bolt and / or casting which could result in pipe joint separation.
- Under torquing the bolts may result in lower pressure retention capabilities, lower bend load capabilities, joint leakage and pipe joint separation. Pipe joint separation may result in significant property damage and serious injury.

### Specified Bolt Torque

Bolt Size	Specified Bolt Torque	
	Lbs-Ft.	N.m
Inch		
3/8	20-30	30-40
1/2	80-100	110-135
5/8	100-130	135-175
3/4	-	-
7/8	-	-



1. Pipe Preparation

Check pipe end for proper groove dimensions and to assure that pipe end is free of indentations and projections that would prevent proper sealing.



2. Lubricate Gasket

Check gasket to be sure it's compatible for the intended service. Apply thin lubricant to the outside and sealing lips of the gasket.

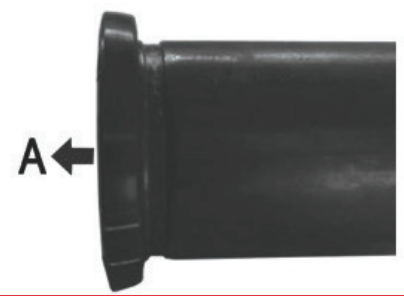

3. Gasket Installation

Slip the gasket over pipe end, with the gasket opening side towards "A". Make sure the gasket sealing lip is even with pipe end.



4. Housing Installation

Remove bolts and nuts, place two housings over the gasket, making sure the housing keys fit into the pipe grooves. Re-insert the bolts and hand tighten the nuts.

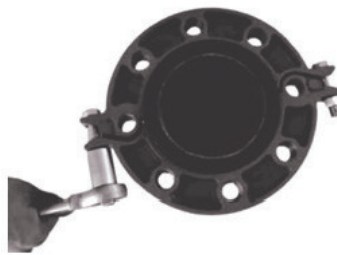

5. Tighten Nuts

Securely tighten nuts alternatively and equally to the specified bolt torque by using spanner.

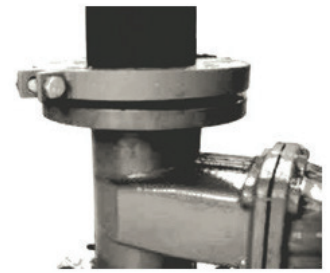

6. Connect Mating Flange

Align flange bolt holes with mating flange (or valve) bolt holes. Insert a standard flange bolt through bolt hole and hand tighten a nut. Insert another bolt opposite the first and hand tighten a nut. Continue this until all bolt holes are fitted. Tighten nuts evenly to specified bolt torque, so flange faces remain parallel. Assembly completed.

### Caution

Proper torquing of bolts is required to obtain specified performance.

- Over torquing the bolts may result in damage to the bolt and / or casting which could result in pipe joint separation.
- Under torquing the bolts may result in lower pressure retention capabilities, lower bend load capabilities, joint leakage and pipe joint separation. Pipe joint separation may result in significant property damage and serious injury.

### Specified Bolt Torque

Bolt Size	Specified Bolt Torque	
	Lbs-Ft.	N.m
M10	30-45	40-60
M12	80-100	110-135
M16	-	-
M20	-	-
M22	-	-
M24	-	-



## Flexible Coupling

1. A flexible coupling accommodates pipe deflection and or non-alignment as below:  
 If nominal diameter <math><DN200</math>, deflection angle is  $\geq 1^\circ$ ; If nominal diameter  $\geq DN200$ , deflection angle is  $\geq 0.5^\circ$  but  $< 1^\circ$

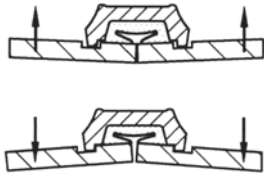

2. The C-shaped rubber gasket : provides excellent self-sealing capabilities in both low and high pressure service as well as under certain vacuum conditions.

3. The design and construction of the coupling with elastomeric gaskets can provide significant noise and vibration absorption as well as seismic stress.

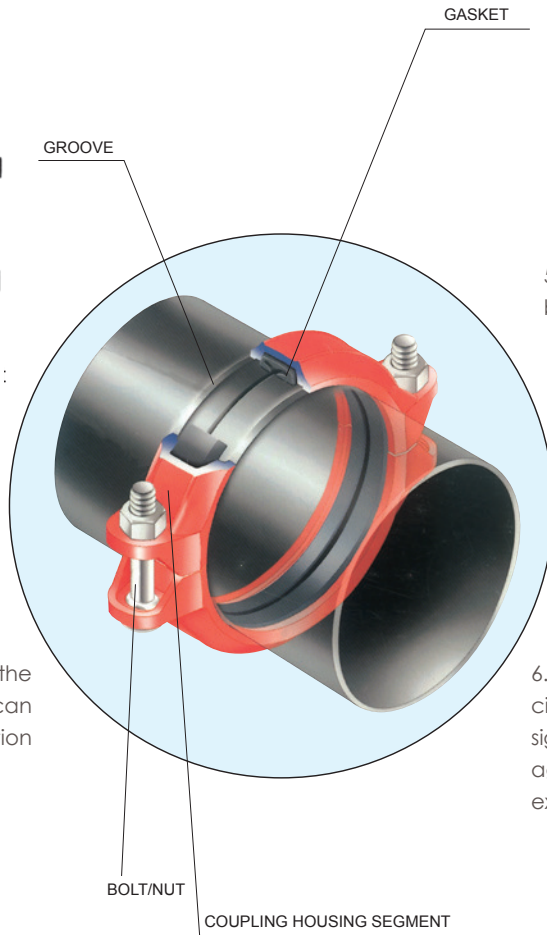
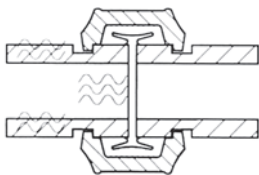

4. With the removal of just a few bolts you can easily access the system for cleaning, maintenance, changes or system expansion.

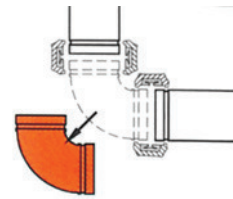

5. Coupling are non-directive and pipe can be rotated 360° during installation.

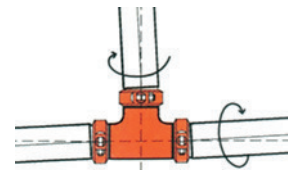

6. Coupling keys engage the full circumference of the grooves and provide significant pressure and end load restraint against pipe movement from internal and external forces.

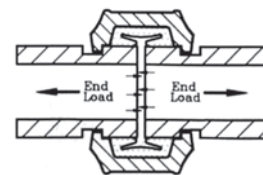





## Rigid Coupling

1. The T&G mechanism in combination with a slightly shortened key diameter provides a mechanical and frictional interlock resulting in a rigid joint which reduces undesired angular movement.

2. The built-in teeth on the coupling grip the groove shoulder and serve to reduce linear movement.

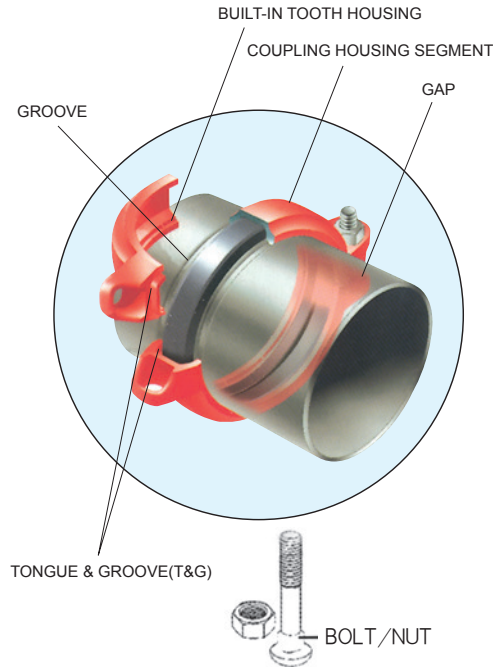

3. The T&G mechanism features a slight offset at the foot of the coupling halves which serve to protect the gasket from exposure.

4. With the T&G style coupling no metal-to-metal contact of the bolt pads is required. You will normally see a 1/16" - 1/8" (1.6mm to 3.2mm) gap between the bolt pads when installed.

## Mechanical Tee Connection

The Mechanical Tee (3J, 3G, 3L) provide for a fast and easy grooved or threaded branch outlet and eliminate the need for welding or the use of a reducing tee and couplings. Simply cut a hole to the specified size at the expected location and fasten the mechanical tee to the pipe with the nuts and bolts provided. As the housing bolts are tightened, the pressure responsive gasket forms a leak-tight seal.

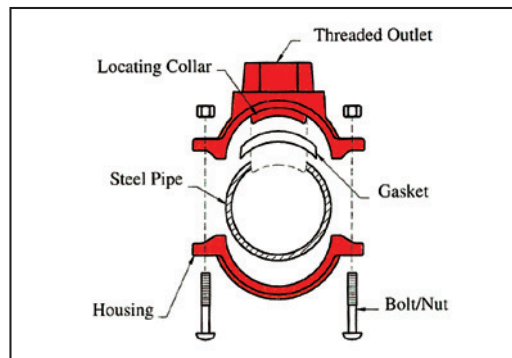
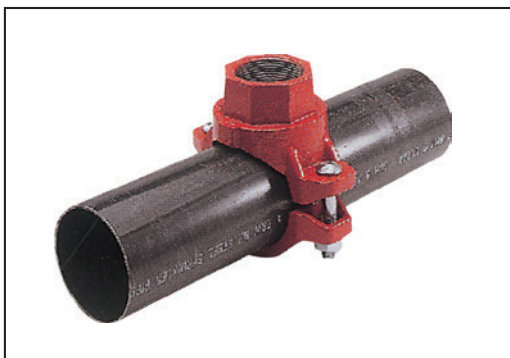



## Movement

Each flexible design coupling can provide for pipe system movement up to the design maximum for the specific size and type coupling being utilized. Movement is possible in the coupling due to two factors: (1) designed-in clearance between the key of the coupling and the groove diameter and groove width, and (2) the gap between pipe ends joined by the coupling.

### 1. Linear Movement

Linear movement is accommodated within the coupling by allowing the pipe ends to move together or apart in response to pressure thrusts and temperature changes. The available linear movement provided by couplings is shown below:

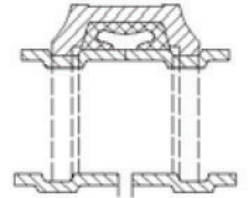

Size	1 - 1¼ (25 - 32 mm)	1½ - 12 (40 - 300 mm)
Movement	0 - 4.0 mm	0 - 6.4 mm

### 2. Angular Movement

Designed-in clearances allow limited deflection of the pipe joint within the coupling, without introducing eccentric loads into the coupling joint.

The maximum available angular movement of coupling joints is shown in the performance data for each coupling type. The amount of angular flexibility varies for each coupling size and type. For design purposes the published figures should be reduced by the below listed factors to account for pipe, groove and coupling tolerances.

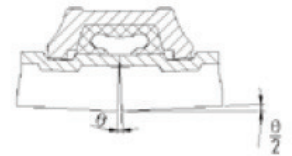

Size	1 - 3 (in)	4 - 12 (in)
Design Factor	Reduce to 50%	Reduce to 75%

## Flexible Couplings: Linear Movement and Angular Movement

Size		Cut			Roll Groove		
		Linear Movement	Angular Movement		Linear Movement	Angular Movement	
Inch	mm	mm/in	mm/in	mm/in	mm/in	mm/in	mm/in
1	33.7	2	2°-45'	48	1	1°-22'	24
1 1/4	42.4	2	2°-10'	38	1	1°-05'	19
1 1/2	48.3	3.2	1°-54'	33	1.6	0°-57'	16.5
2	60.3	3.2	1°-31'	26	1.6	0°-45'	13
2 1/2	73	3.2	1°-27'	25	1.6	0°-43'	12.5
2 1/2	76.1	3.2	1°-12'	21	1.6	0°-36'	10.5
3	88.9	3.2	1°-02'	18	1.6	0°-31'	9
4	108	3.2	1°-51'	32	1.6	0°-55'	16
4	114.3	3.2	1°-36'	28	1.6	0°-48'	14
5	133	3.2	1°-41'	30	1.6	0°-50'	15
5	139.7	3.2	1°-19'	23	1.6	0°-37'	11.5
5	141.3	3.2	1°-03'	18	1.6	0°-30'	9
6	159	3.2	1°-18'	23	1.6	0°-39'	11.5
6	165.1	3.2	1°-05'	20	1.6	0°-35'	10
6	168.3	3.2	1°-05'	19	1.6	0°-32'	9.5
8	219.1	3.2	0°-50'	15	1.6	0°-25'	7.5
10	273	3.2	0°-40'	12	1.6	0°-20'	6
12	323.9	3.2	0°-34'	10	1.6	0°-18'	5

## Movement Application

### Thermal stress

Thermal stress is caused by changes in temperature, resulting in either expansion or contraction. When designing a system you must allow for this thermal movement. To determine the appropriate number of flexible couplings to allow for this thermal movement please refer to the following.

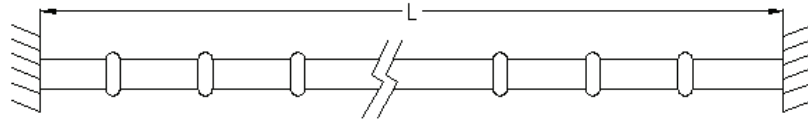

Example:

- 4" straight steel pipe, 30m long
- Anchored on both ends
- Minimum temperature (during installation) = 5°C
- Maximum working temperature = 55°C

From the thermal expansion table, we know the overall pipeline length will increase by 18mm (0.71"). You can also use Formula 1 or Table 3 to find the amount of thermal expansion. We want to know the number of couplings that are required to address this thermal movement problem.

The allowed movement of a 4" flexible coupling is:

- Movement range x Adjustment = Allowed movement
- 4.3mm x 75% = 3.2mm
- The appropriate number of coupling is:
- Thermal expansion / Allowed movement = Number of couplings
- 18mm / 3.2mm = 5.6

Conclusion:

The appropriate number of coupling is 6.

## Thermal Expansion

Temperature Difference (°C)	Pipe length (m)					
	1	5	10	20	30	40
	Thermal Expansion(mm)					
1	0.012	0.06	0.12	0.24	0.36	0.48
5	0.06	0.3	0.6	1.2	1.8	2.4
10	0.12	0.6	1.2	2.4	3.6	4.8
20	0.24	1.2	2.4	4.8	7.2	9.6
30	0.36	1.8	3.6	7.2	11	15
40	0.48	2.4	4.8	9.6	14	20
50	0.6	3	6	12	18	24
60	0.72	3.6	7.2	14	22	29
70	0.84	4.2	8.4	17	25	34
80	0.96	4.8	9.6	19	29	39

Thermal Expansion Formula 1

$$\lambda = \alpha \times L \times T$$

$\lambda$ : Thermal Expansion

$\alpha$ : Linear Expansion

Coefficient for steel

L: Pipe length

T: Temperature difference





## Riser Design

Risers assembled with Flexible couplings are generally installed in either of two ways. In the most common method, the pipe ends are butted together within the coupling joint. Note that when installing risers, the gasket is first placed onto the lower pipe and rolled back away from the pipe end prior to positioning the upper pipe. Anchoring of the riser may be done prior to pressurization with the pipe ends butted or while pressurized, when, due to pressure thrust, the pipe ends will be fully separated.

An alternative method of riser installation is to place a metal spacer of a predetermined thickness, between the pipe ends when an additional length of pipe is added to the riser stack. The upper pipe length is anchored, the spacer removed and the coupling is then installed. This method creates a predetermined gap at each pipe joint which can be utilized in pipe systems where thermal movement is anticipated and in systems with rigid (threaded, welded, flanged) branch connections where shear forces due to pressure thrust could damage the rigid connections.

The following examples illustrate methods of installing commonly encountered riser designs.

### Risers without Branch Connections

Install the riser with the pipe ends butted.

Locate an anchor at the base of the riser (A) to support the total weight of the pipe, couplings and fluid. Provide pipe guides on every other pipe length, as a minimum, to pre-vent possible deflection of the pipe line at the coupling joints as the riser expands due to pressure thrust or thermal growth. Note that no intermediate anchors are required. When the system is pressurized the pipe stack will "grow" due to pressure thrust which causes maximum separation of pipe ends within the couplings. The maximum amount of stack growth can be predetermined (see Linear Movement). In this example the pipe length "L" at the top of the riser must be long enough to permit sufficient deflection (see Angular Movement) to accommodate the total movement "M" from both pressure thrust and thermal gradients.



### Risers with Branch Connections

Install the riser with the predetermined gap method. Anchor the pipe at or near the base with a pressure thrust anchor "A" capable of supporting the full pressure thrust, weight of pipe and the fluid column. Anchor at "B" with an anchor capable of withstanding full pressure thrust at the top of the riser plus weight of pipe column. Place intermediate anchors "C" as shown, between anchors "A" and "B". Also place intermediate clamps at every other pipe length as a minimum.

When this system is pressurized, the pipe movement due to pressure thrust will be strained and there will be no shear forces acting at the branch connections.

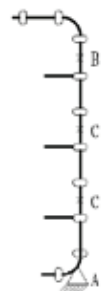



## Misalignment & Deflections

The angular movement capability of the flexible coupling permits the assembly of pipe joints where the piping is not properly aligned . At least two couplings are required to provide for lateral pipe misalignment . Deflection (longitudinal misalignment) may be accommodated within a single coupling as long as the angle of deflection does not exceed the value shown in the coupling performance data for the particular size and coupling type .

A pipe joint that utilizes the angular deflection capability of the coupling will react to pressure and thermal forces dependent upon the manner in which it is restrained . An unrestrained joint will react to these forces by straightening, thus reducing, if not eliminating, the deflection at the joint . If joint deflection has been designed into the pipe layout and must be maintained, then sufficient anchors must be provided to resist the lateral forces and hold the joint in the deflected condition .

The amount of deflection from pipe run centerline can be calculated utilizing the following equations:

$$M = L \sin\theta$$

$$\theta = \sin^{-1} (G \div D)$$

$$M = (G \div D) \times L$$

Where:

M = Misalignment (inches)

G = Maximum Allowable Pipe End Movement (Inches) as shown under "Performance Data"  
(Value to be reduced by Design Factor)

$\theta$  = Maximum Deflection (Degrees) from centerline as shown under "Performance Data"  
(Value to be reduced by Design Factor)

D = Pipe Outside Diameter (Inches)

L = Pipe Length (Inches)

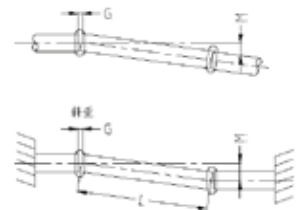

## Curve Layout

Utilizing the angular deflection at each coupling joint curves may be laid out using straight pipe lengths and Couplings.

This example shows how to calculate the curve radius, required pipe lengths, and number of required couplings.

$$R = L / (2 \times \sin(\theta/2))$$

$$L = 2 \times R \times \sin(\theta/2)$$

$$N = T / \theta$$

Where:

N = Number of Couplings

R = Radius of Curve (feet)

L = Pipe Length (feet)

$\theta$  = Deflection from centerline (Degrees) of each Coupling

(See coupling performance data, value to be reduced by Design Factor)

T = Total Angular Deflection of all Couplings.

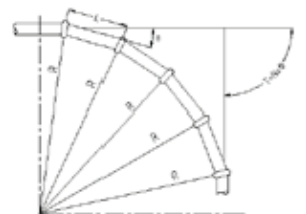



## Anchoring and Supports

When designing the hangers, supports and anchors for a grooved end pipe system, the piping designer must consider certain unique characteristics of the grooved type coupling in addition to many universal pipe hanger and support design factors. As with any pipe system, the hanger or support system must provide for

1. The weight of the pipe, couplings, fluid and pipe system components;
2. Reduce stresses at pipe joints; and
3. Permit required pipe system movement to relieve stress.

The following chart shows the maximum span between pipe hangers, supports and anchors.

## Max. Span between Supports (steel pipe)

Nominal Size (mm)		15	20	25	32	40	50	70	80	100	125	150	200	250	300
Max. Span Between Supports (mm)	Insulating Pipe	2	2.5	2.5	2.5	3	3	4	4	4.5	6	7	7	8	8.5
	Non-Insulating Pipe	2.5	3	3.5	4	4.5	5	6	6	6.5	7	8	9.5	11	12

## Movement capability of couplings-expansion and contraction joints

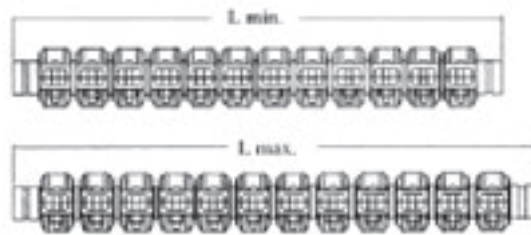

Nominal Size	Pipe O.D. (mm)	Maximum Allowable Movement (mm)	L min. (mm)	L max. (mm)	Number of Couplings	Filled With Water Pressure
1	33.7	45	617	662	10	300
1¼	42.4	45	617	662	10	300
1½	48.3	45	617	662	10	300
2	60.3	45	617	662	10	300
2½	73	45	617	662	10	300
76.1	76.1	45	617	662	10	300
3	88.9	45	617	662	10	300
4	114.3	47	503	550	7	300
139.7	139.7	47	503	550	7	300
5	141.3	47	503	550	7	300
165.1	165.1	52	591	550	7	300
6	168.3	52	591	643	7	300
8	219.1	52	591	643	7	300
10	273	52	591	643	7	300
12	323.9	52	591	643	7	300

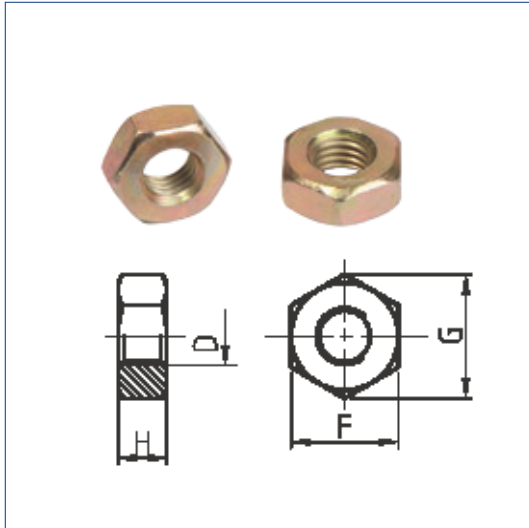

## Metric Heavy Hex Nut

1. Material: ISO 898-2:1992 \ GB/T3098.2-2000 Class 8.
2. Thread: ISO 261, tolerance 6h for M10& M12, 7h for M16 and above.
3. Surface Treatment: Zinc Electroplated followed by a yellow chromate dip per ISO 2081 FE/ZN5. ISO4520 CLASS 1A.

d	F		G	H	
	Min	Max	Min	Min	Max
M10	15.73	16.0	17.7	8.0	8.4
M12					
M16					
M20					
M22					

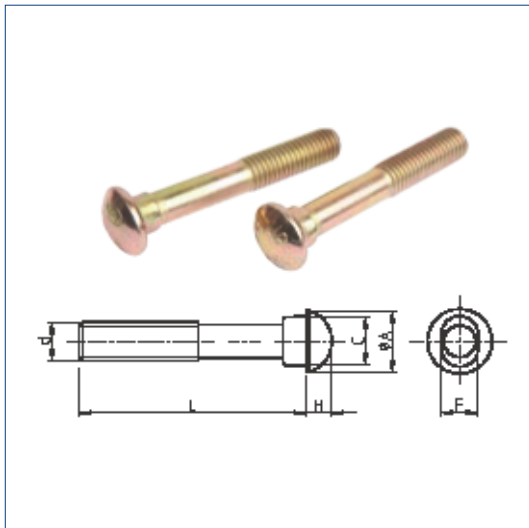

## Metric Oval Neck Track Bolt

1. Material: ISO 898-1:1992 \ GB/T3098.1-2000 Class 8.8.
2. Thread: ISO metric thread per ISO 261, tolerance 6h.
3. Surface Treatment: Yellow chromate electroplated per ISO 2081 FE/ZN5 ISO4520 CLASS 1A.

d	A	C	F	H	L
M10	18.5	13.5	9.5	5	50/57/63/70/89
M12	23.5	17.5	12.3	8	70/76/82/89/108
M16	29.5	20.5	15.7	10	85/89/95/108
M20	38	27	18.3	12.5	110/115
M22	42.2	31	21.4	14	125/140/150



## Engineering Test

No.	Item	Standard Requirements
1	Vacuum Test	Grooved couplings, grooved reducing couplings, grooved split flanges, mechanical tees, and plain end couplings shall be able to withstand the effects of vacuum conditions encountered when sprinkler systems are drained. Samples of each nominal size and style of gasketed coupling and fitting shall be subjected to an internal vacuum of 25 inHg (85 kPa) for a duration of 5 minutes. Following the vacuum test, the test assembly shall be pneumatically pressurized from zero to 50 psi (345 kPa) while submerged in a water bath. There shall be no leakage or permanent deformation as a result of this test
2	Hydrostatic Strength Test	All items shall be able to withstand an internal hydrostatic pressure equal to three-five times the rated working pressure without cracking, rupture, or permanent distortion. The test shall be conducted for a duration of 1 minute. Test Size ≤6" Five times 8"-10" 4 times ≥12" 3 times
3	Air Leakage Test	The coupling assembly shall be pressurized with air to 3 bar +0.5/-0 bar. The assembly shall be immersed in water to establish that there is no visible leakage
4	Moment Test	The moment resistance shall be demonstrated while the test assembly is internally pressurized to the rated working pressure. Then a force was applied to the test assembly. There shall be no leakage, cracking, or fitting or coupling pull-off as a result of this test.
5	Hot Gasket Test	Standard gaskets shall be assembled to short lengths of pipe, and subjected to 275°F (135°C) for a duration of 45 days. After exposure, the test assembly shall be submerged in a water bath and subjected to an air under water leakage test from zero to 50 psi (0 to 345 kPa) in order to evaluate for leakage. After the air under water testing is completed, the test assembly shall be disassembled and the gasket shall not crack when squeezed together from any two diametrically opposite points, or twisted into a figure-eight shape. The gasket shall then be visually inspected for signs of cracking, tearing, or excessive degradation as a result of this test.
6	Cold Gasket Test	The low temperature exposure shall consist of -40 °F (-40 °C) air exposure for 4 days. After exposure, the assembly while submerged in -40 °F (-40 °C) antifreeze, shall be pneumatically pressurized from 0 to 50 psi (0 - 345 kPa). No leakage shall occur. The assembly shall then be allowed to warm to ambient temperature and then be disassembled. The gasket, after removal from the assembly, shall not crack when squeezed together from any two diametrically opposite points, or twisted into a figure eight shape.
7	Flame test	The test shall be conducted in a room free from air draught. The test joint is mounted, U-bent on the test apparatus and filled with water. The angle corresponds to the angle documented as a result of the test Subsequently the test joint is drained. The fuel pan is placed centrally below the pipe joint Fuel is filled into the pan and the fuel is ignited, Burning time 5 min for nominal diameters < DN 100; 8 min for nominal diameters ≥ DN 100 For reducer couplings the dimension of the smaller nominal diameter shall apply for the determination of the burning time. The flame shall be extinguished immediately once the burning time has expired (5 min or 8 min) and the test joint shall be cooled down. For cooling the test joint is immediately sprayed with water until steam formation is no longer visible, but at least for 3 min. The test joint is then filled completely with water and exposed to a test pressure which corresponds to the maximum permissible pressure and is checked visibly for leaks. Water may leak in form of drops, however, not in form of flowing water or a water spray. The test joint is then pressure relieved (force and internal pressure).
8	Cycling Pressure Resistance (Water Hammer Test)	Prior to the cycling, assemblies shall be subjected to a hydrostatic strength test to the rated working pressure, 175 psi (1205 kPa) minimum, for a duration of 5 minutes. Without leakage or cracking. Assemblies shall then be subjected to 20,000 cycles from zero pressure to the rated working pressure, 175 psi (1205 kPa) minimum. After cycling, the test assembly shall be tested Hydrostatic Strength and maintain 5 minutes without leakage and cracking.



## Engineering Test

No.	Item	Standard Requirements
9	Friction Loss Determination	The construction and installation of the coupling or fitting shall be such that obstruction to the passage of water through the coupling or fitting body is minimal. The loss in pressure through the coupling or fitting shall not exceed 5.0 psi (35 kPa) at a flow producing a velocity of 20 ft/s (6.1 m/s) in Schedule 40 steel pipe of the same nominal diameter as the coupling or fitting.
10	Leakage Test - Assembly without Gasket	Leakage from a gasket-less coupling assembly or fitting shall not exceed that of an operating sprinkler head whose discharge coefficient (K-factor) is 5.3 to 5.8 gal/min(psi) <sup>1/2</sup> [76 - 84 L/min/(bar) <sup>1/2</sup> ]. This test is for nominal pipe sizes normally associated with over-head piping, less than or equal to 12 in. NPS (300 mm).
11	Torsion test	This test relates to pipe joints ≤ DN 40 only. The test joint is filled with water and exposed once to the maximum permissible pressure and is then pressure relieved again. Subsequently the test joint is fixed on one pipe end and an increasing torque is applied to the other pipe end. At the pressureless test joint the pipe joint shall be able to transmit a torque of up to 80 Nm from one pipe end to the other pipe end without any torsion of the pipe ends against each other.
12	Flexibility Test for Flexible Fittings	With the assembly pressurized to its rated pressure, a bending moment is to be applied to deflect the joint to the maximum angle specified by the manufacturer, while not less than 1 degree for nominal pipe diameters less than 8 inches (203.2 mm) or 0.5 degrees for 8 inches (203.2 mm) and larger. Observations are to be made for leakage or pipe damage.
13	Seismic Evaluation	In order to evaluate the use of grooved couplings in Earthquake zones 50 through 500 years, test assemblies utilizing flexible couplings and short lengths of steel pipe, in the same nominal size, will be subjected to cyclic testing. The test will deflect the assembly to the manufacturer's maximum recommended angle in the forward and reverse direction for a total 15 cycles with the internal pressure equal to the rated working pressure. There shall be no leakage, cracking, or rupture as a result of this test.
14	Lateral Displacement	The coupling shall not leak during any of the tests, within the manufacturer's stated limitations for angular deflection or lateral displacement of associated pipework.
15	Hydrostatic fluctuation pressure test	The coupling assembly shall be pressurized with water to a gauge pressure of 10 bar ±1 bar for 2min, +30s/-0s to establish a datum. The assembly shall then be drained before being subjected to the greatest vacuum attainable to a maximum of 600mm a/mercury or -0.8bar +0bar/-0.1 bar for 2min +30s/-0s, and allowed to return to atmospheric pressure in not less than 5s. The assembly shall then be pressurized with water to 10 bar ±1bar for 2 min +30s/-0s. The assembly shall be examined for leakage throughout the test. The relative movement of each pipe shall be recorded at the greatest vacuum and at each pressure. There shall be no leakage.
16	Fire Test	If a gasketed pipe coupling or fitting employs non-ferrous materials for its substantial structural components, or if in the judgment of FM Approvals, the design is otherwise suspect with respect to fire resistance, a fire test shall be conducted. A representative size assembled joint without a gasket shall be exposed to a 1000 °F (538 °C) fire environment for 5 minutes. The assembly shall be dry for the duration of this exposure. Immediately after the exposure, a water flow shall be introduced through the joint and sustained until the assembly is cool to the touch. No cracking or distortion of any component of the coupling or fitting shall occur. The coupling or fitting shall then be disassembled and the gasket installed. After reassembly, the joint shall be hydrostatically tested, as described in to the hydrostatic test.





# Rapidrop Catalogues



**Rapidrop Global Ltd**  
British Manufacturer of Fire Detection & Suppression Equipment

Product Range



[www.rapidrop.com](http://www.rapidrop.com)





**Rapidrop Global Ltd**  
British Manufacturer of Fire Detection & Suppression Equipment

Fire Sprinkler Range



[www.rapidrop.com](http://www.rapidrop.com)





**Rapidrop Global Ltd**  
British Manufacturer of Fire Detection & Suppression Equipment

Flexible Sprinkler Connections



[www.rapidrop.com](http://www.rapidrop.com)



**Rapidrop Global Ltd**  
British Manufacturer of Fire Detection & Suppression Equipment

Pump Room Equipment



[www.rapidrop.com](http://www.rapidrop.com)



# Rapidrop Catalogues



**Rapidrop Global Ltd**  
British Manufacturer of Fire Detection & Suppression Equipment  
Wet & Dry Riser Equipment





[www.rapidrop.com](http://www.rapidrop.com)



**Rapidrop Global Ltd**  
British Manufacturer of Fire Detection & Suppression Equipment  
Rapidrop Jactone Range





[www.rapidrop.com](http://www.rapidrop.com)

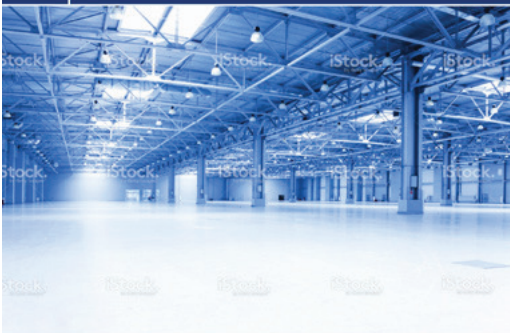

**Rapidrop Global Ltd**  
British Manufacturer of Fire Detection & Suppression Equipment  
Special Risk



[www.rapidrop.com](http://www.rapidrop.com)



**Rapidrop Global Ltd**  
British Manufacturer of Fire Detection & Suppression Equipment  
World Wide Projects



[www.rapidrop.com](http://www.rapidrop.com)