

**K-505**    SIZE:1100X750X2000

**K-506**    SIZE:1200X800X2000

## TOOLS REQUIRED (NOT SUPPLIED)

-When you're ready to start, make sure that you have the following tools to hand, plenty of space and a clean dry area for assembly.  
Two people are needed. Please note: although these instructions are comprehensive, we always recommend that a technically competent installer should undertake installation.



Spirit Level

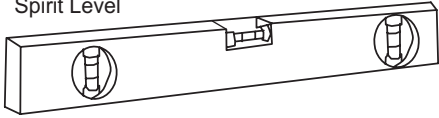

Pencil



Ruler

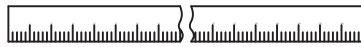

Tape Measure

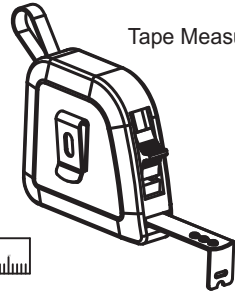

3mm Diameter Drill Bit



6mm Diameter Drill Bit



Cross head driver bit



Power Drill

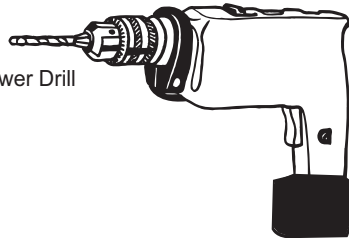

Magnetic Crosshead Screwdriver

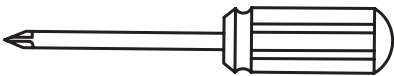

Rubber Hammer



Scissors

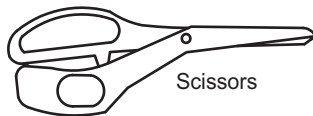



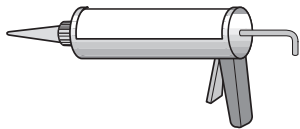



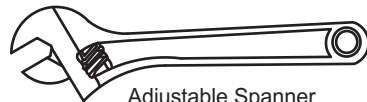

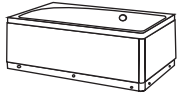

Silicone Sealant



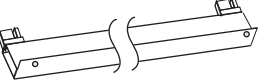

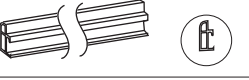
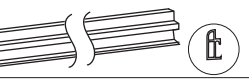

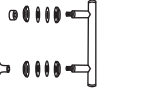



Adjustable Spanner

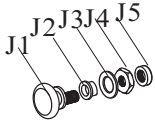

## Part list

Item no	Description	Product	Quantity
A	waste siphon		1
B	(B1)Fixed glass		1
	(B2)Fixed glass		1
C	(C1)Movable glass		1
	(C2)Movable glass		1
D	Profile		2
E	(E1)Curved track(Top)		1
	(E2)Curved track(Top)		1
	(E3)Curved track(Bottom)		1
	(E4)Curved track(Bottom)		1
F	Track connector		2
G	Handle		2
H	Glass Stopper		8

# Part List

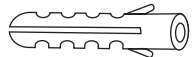
Item no	Description	Product	Quantity
I	Glass Clamp		4
J	Wheel set		8
K	Screw Cover Cap	K1   K2	8
L	(L1)Spalsh seal		4
	(L2)Magnetic seal		2
	(L3) seal		2
M	(M1)Cross Head Screw ST4x16mm		8
	(M2)Cross Head Screw ST4x30mm		8
	(M3)Cross Head Screw ST4x10mm		14
N	Wall Plug		8

# Installation

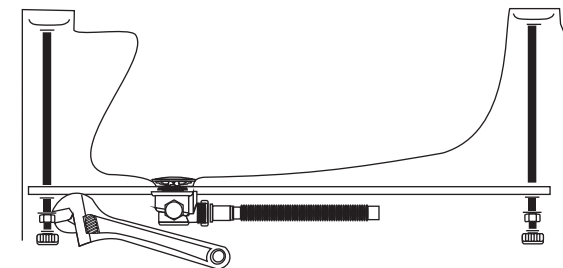
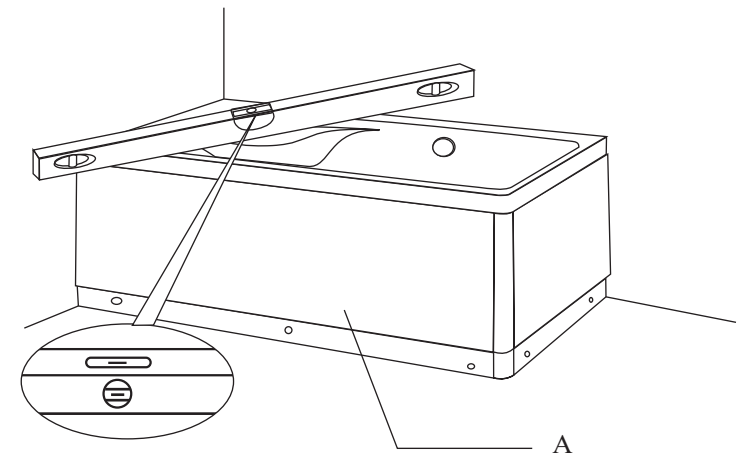
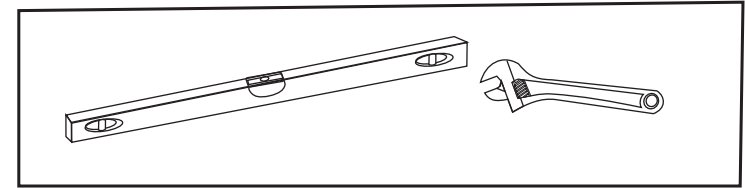

# Installation

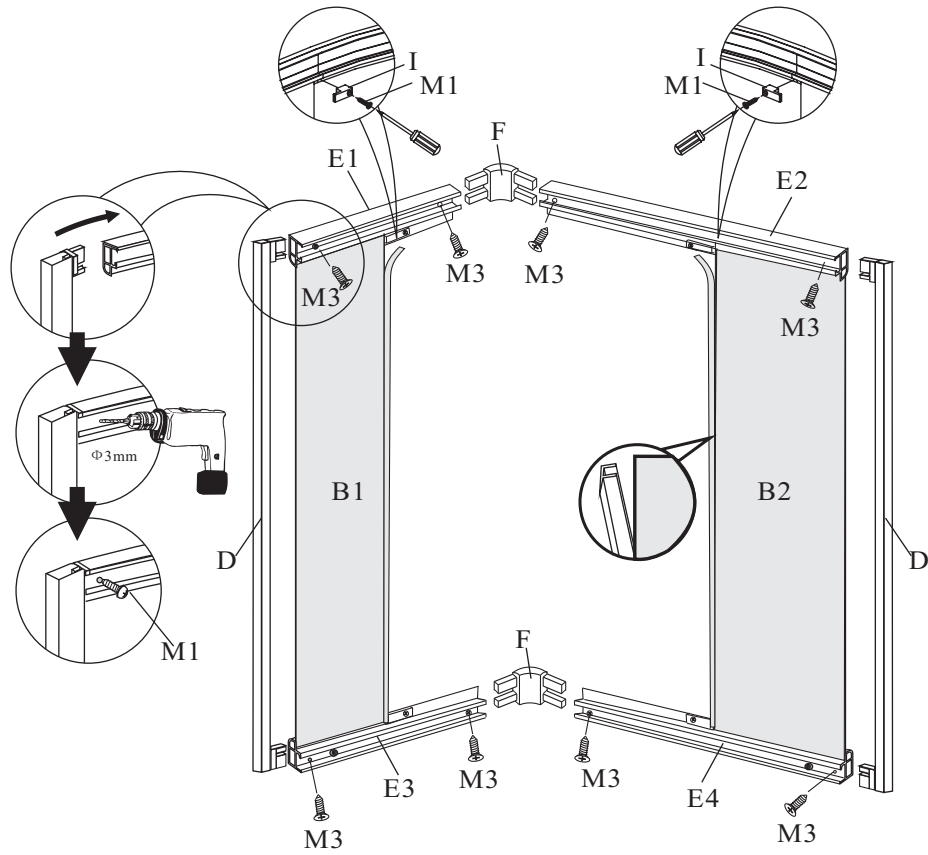

5

# Installation

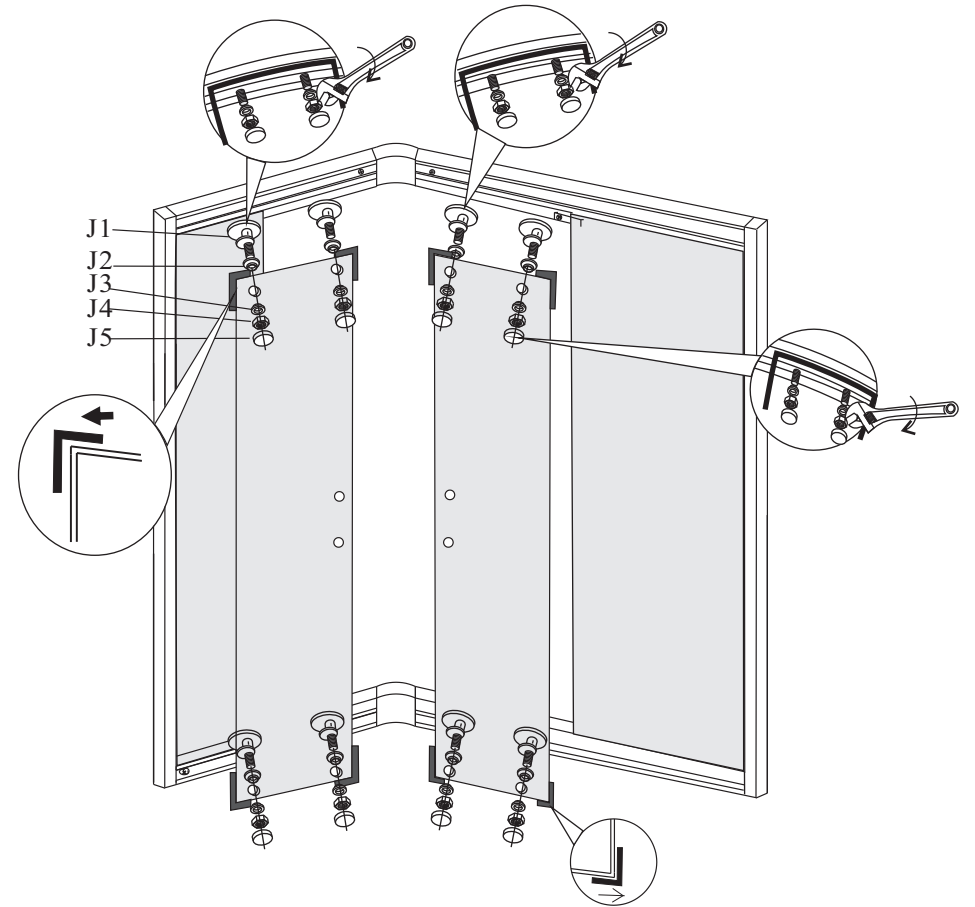

6

# Installation

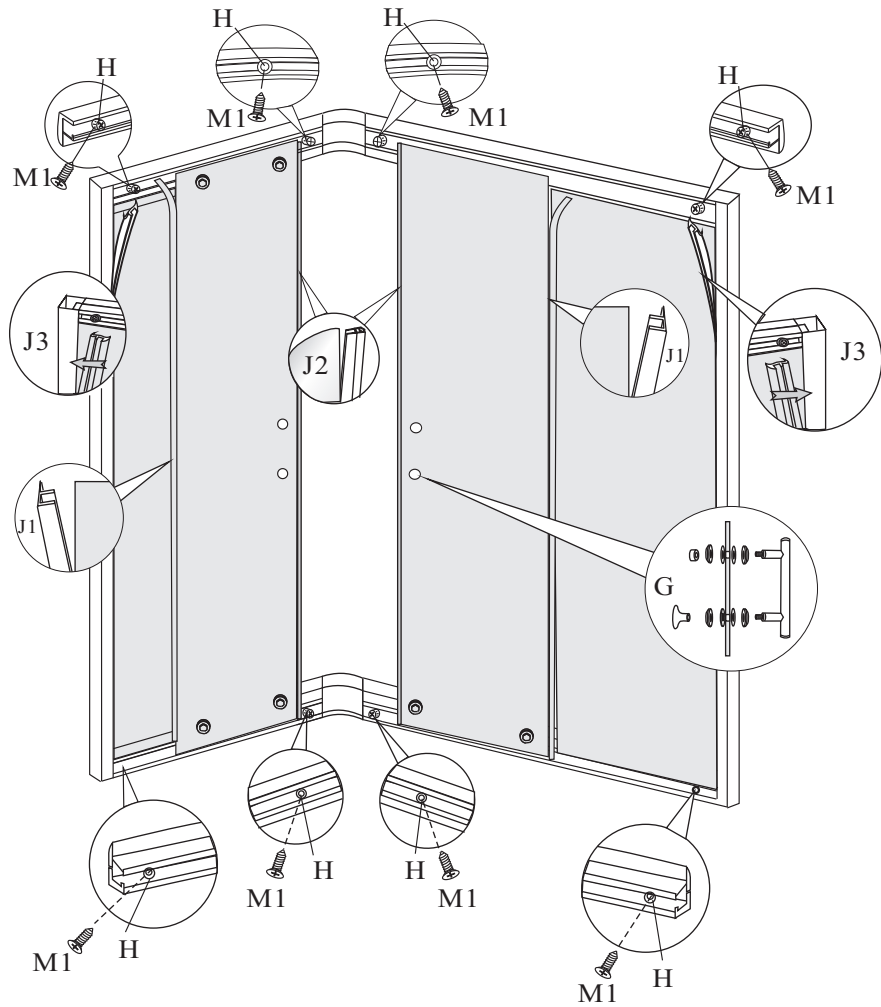

# Installation

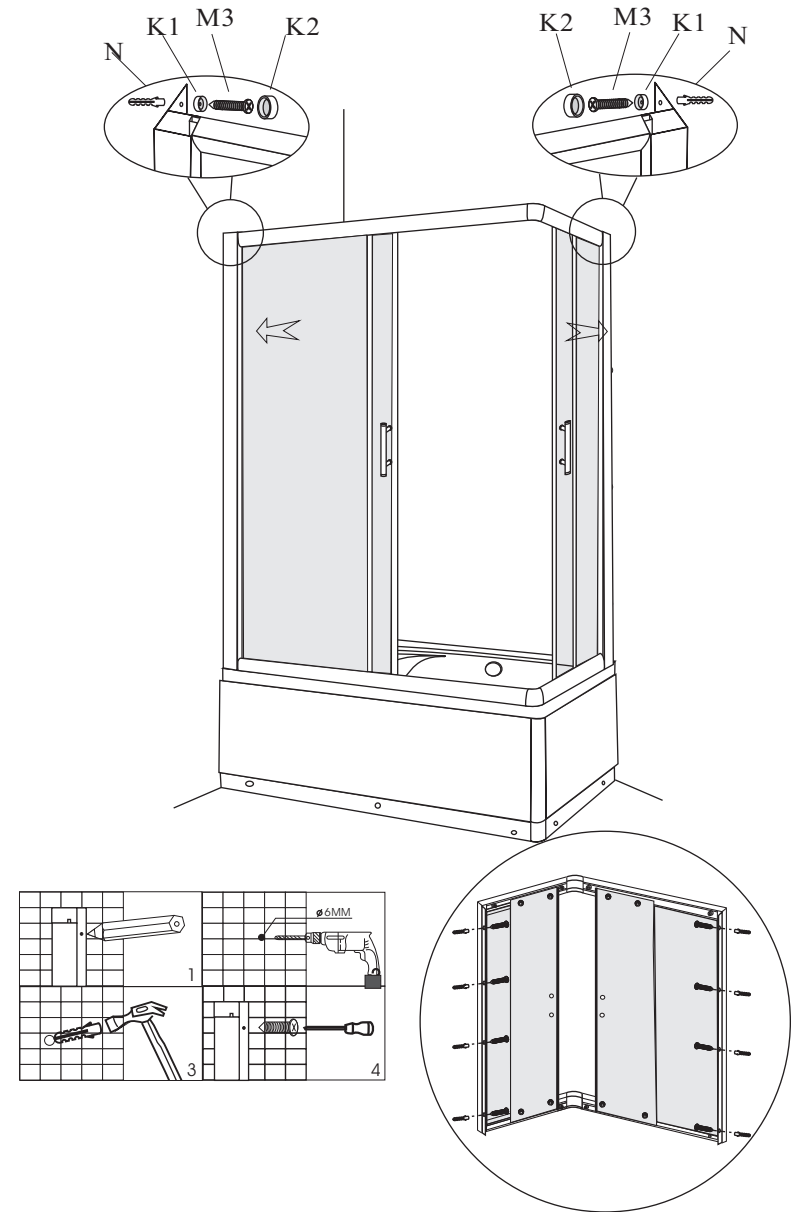

# Installation

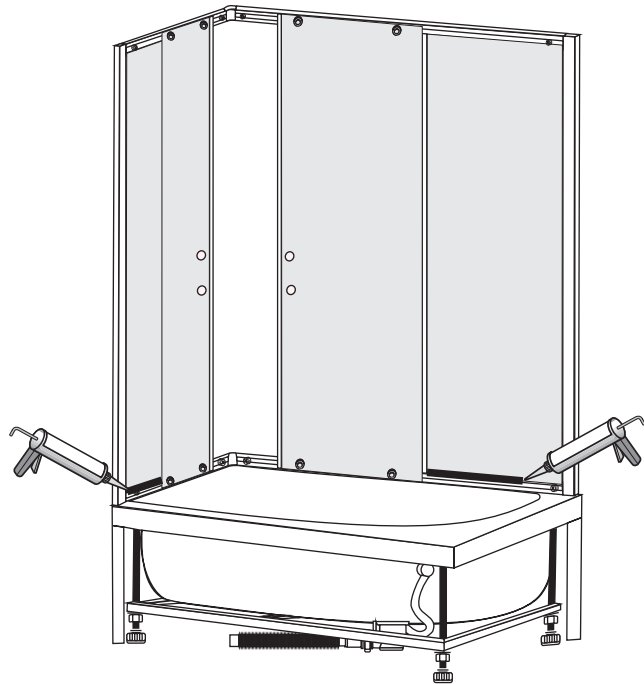

# Installation

