

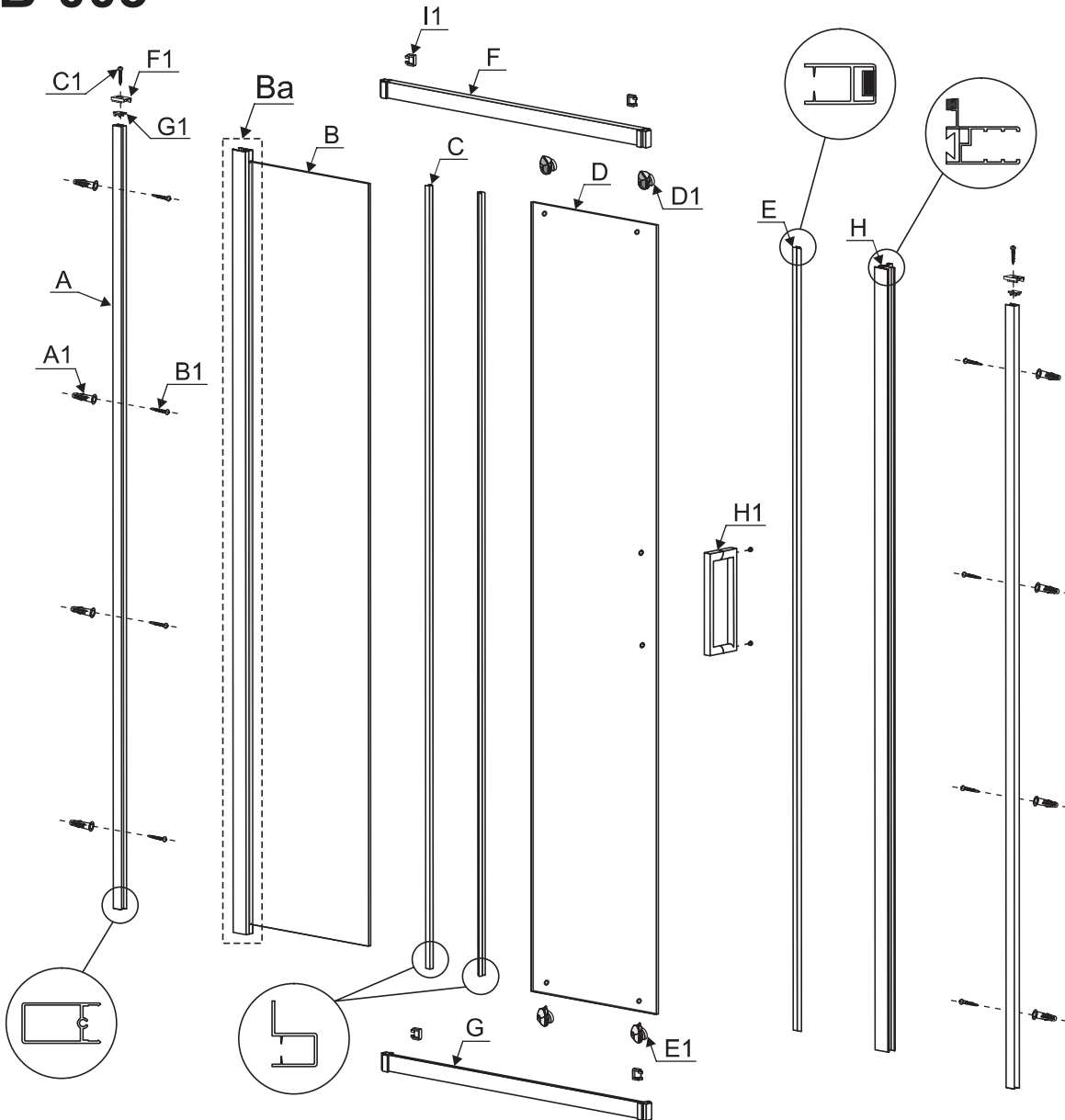







EAB-003

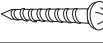
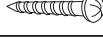

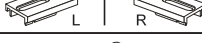
Fixing kit includes

Ref	Description	Qty
A	Wall profile	2
B	Fixed glass	1
Ba	Vertical profile	1
C	Rubber seal	2
D	Sliding door	1
E	Magnetic rubber seal	1
F	Top Rail	1
G	Bottom Rail	1
H	Vertical profile	1

Ref	Description	Illustration	Qty
A1	Wall plug		8
B1	4x25mm		8
C1	4x20mm		2
D1	Top Roller		2
E1	Bottom Roller		2
F1	Cover cap		2
G1	Connection fittings		2
H1	Handle		1
I1	Connection fittings		4