

 S.O.ERRE

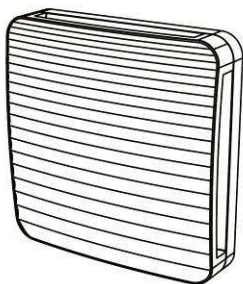

**IN
ALBA**

**UNICO
ONDA**

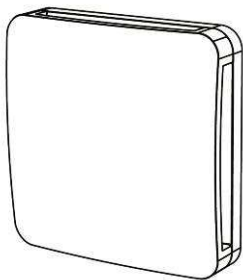
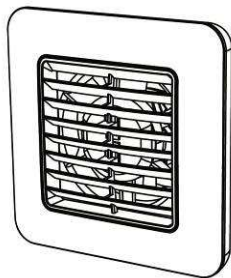
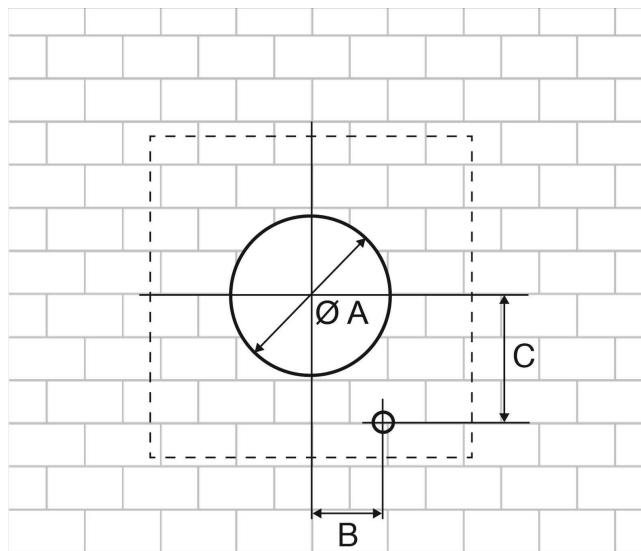

	ØA	B	C
9/3,5"	92,5	/	/
10/4"	100,0	37,20	64,50
12/5"	120,0	40,25	74,50
15/6"	150,0	50,00	89,00

IN

9/3,5

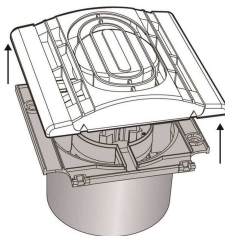

10/4
12/5
15/6

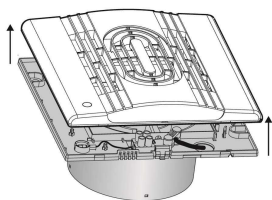

IN A

10/4
12/5
15/6

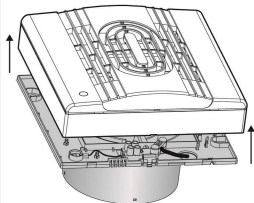

UNICO / UNICO C

9/3,5

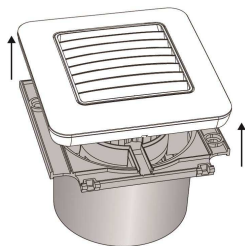

10/4
12/5
15/6

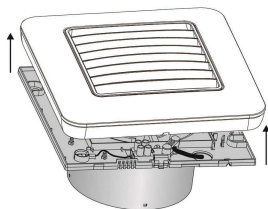

ALBA-ONDA

10/4
12/5
15/6

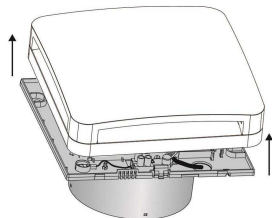

A



9/3,5

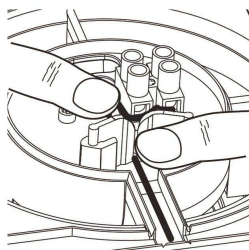
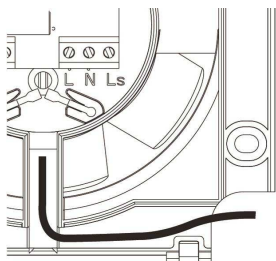

10/4 - 12/5 - 15/6

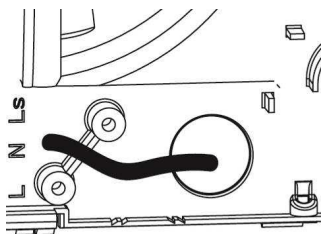
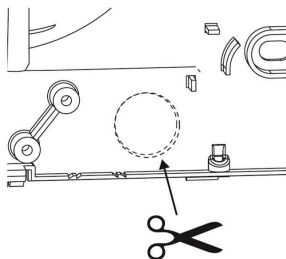

B



9/3,5

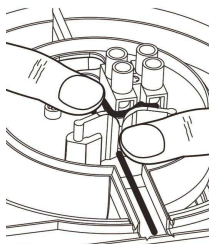
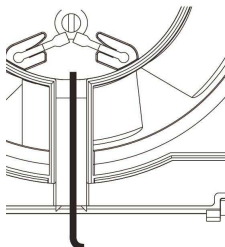
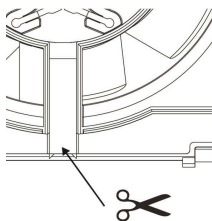

10/4 - 12/5 - 15/6

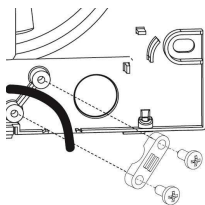
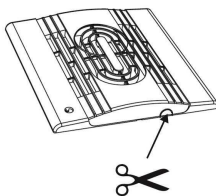
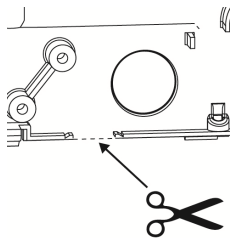

SELV 12V

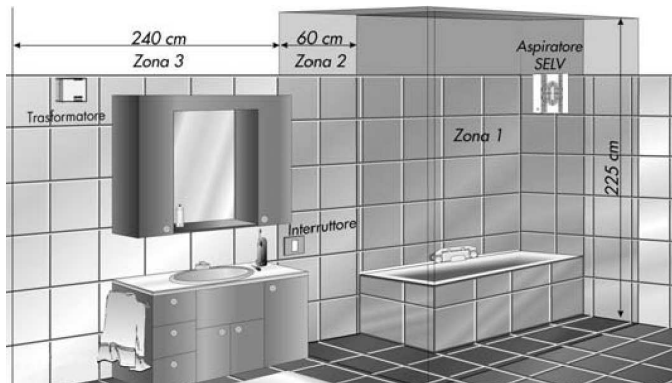

- Zone 1 e 2 divieto d'installazione apparecchi a 220-240V (esempio dalla Norma CEI 64-8 per impianti elettrici).
- Zone 1 and 2 installation of 220-240V appliances is prohibited (example from the Standard IEC 364-7 for electrical systems).
- Volumes de sécurité 1 et 2 défense d'installation d'appareils 220-240V (exemple tiré de la Norme CEI 364-7 pour l'installation électriques).
- Zone 1 und 2 verbot der Installation von Apparaten mit 220/240V. (Beispiel der Norm IEC 364-7 für Elektroanlagen).
- Zones 1 en 2 installatieverbod voor toestellen van 220-240V (Voorbeeld van de EEG Reglement 64/8 voor elektrische installaties).

- Volumen de seguridad 1 y 2 prohibida la instalación de aparatos 220-240 V (ejemplo sacado de la Norma CEI 364-7 para instalaciones eléctricas).
- Instalação de aparelhos de 220-240V é proibida na Zona 1 e 2. (informação retirada da Norma CEI 364-7 - para instalações eléctricas).
- Απαγορεύεται η εγκατάσταση συσκευών 220-240 στις ζώνες 1 και 2 (παράδειγμα από την προδιαγραφή ΙΕC 364-7 για τις ηλεκτρικές εγκαταστάσεις).
- В зонах 1 и 2 устанавливать электрооборудование с напряжением электропитания 220-240 В ЗАПРЕЩАЕТСЯ (выдержка из стандарта IEC 364-7 для электротехнических систем).

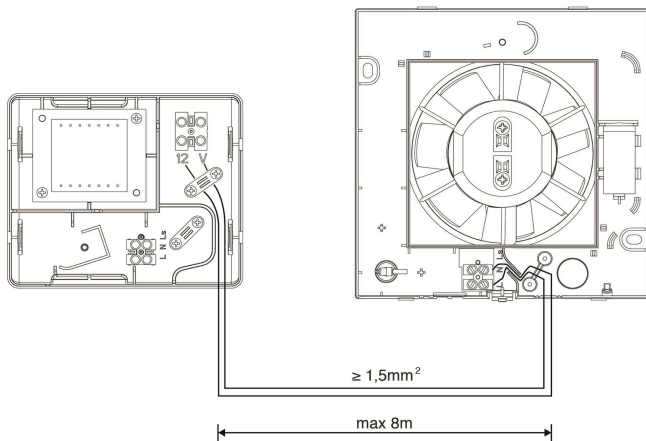

IN – IN A – UNICO – UNICO C – ALBA – ONDA
 9/3,5 – 10/4 – 12/5 – 15/6 – 10/4 BB – 12/5 BB – 15/6 BB
 ALIMENTATORE 12V SELV

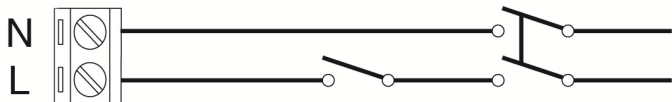

IN – IN A – UNICO - UNICO C
 10/4 PC – 12/5 PC – 15/6 PC – 10/4 BB PC – 12/5 BB PC – 15/6 BB PC –
 ALIMENTATORE 12V PC

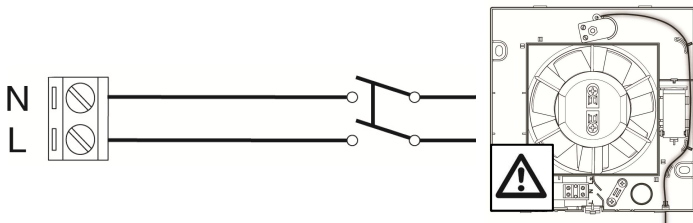

IN – IN A – UNICO - UNICO C
 10/4 PIR – 12/5 PIR– 15/6 PIR– 10/4 BB PIR– 12/5 BB PIR– 15/6 BB PIR

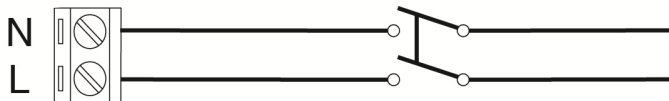

IN – IN A – UNICO - UNICO C – ALBA – ONDA
9/3,5 T - 10/4 T - 12/5 T - 15/6 T - 10/4 BB T - 12/5 BB T - 15/6 BB T –
ALIMENTATORE 12V SELV TIMER

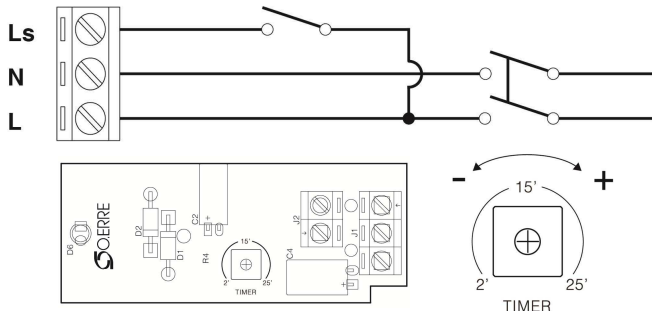

IN – IN A – UNICO - UNICO C – ALBA – ONDA
10/4 HT- 12/5 HT -15/6 HT - 10/4 BB HT - 12/5 BB HT - 15/6 BB HT –
ALIMENTATORE 12V SELV HT

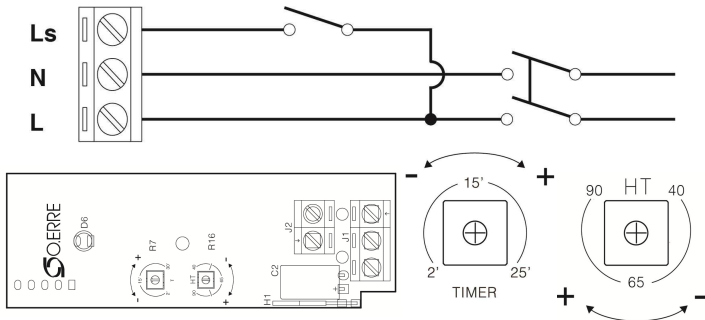

IN

9/3,5

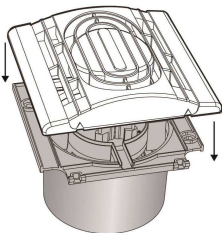

10/4
12/5
15/6

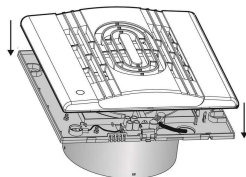

IN A

10/4
12/5
15/6

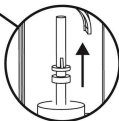

OFF  ON

30"

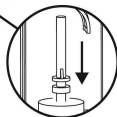
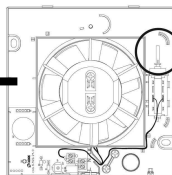
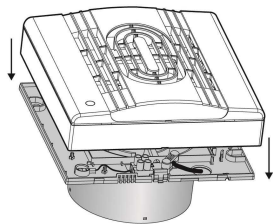

UNICO / UNICO C

9/3,5

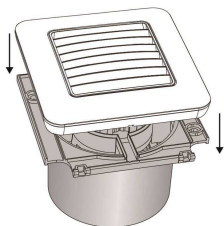

10/4
12/5
15/6



ALBA-ONDA

10/4
12/5
15/6

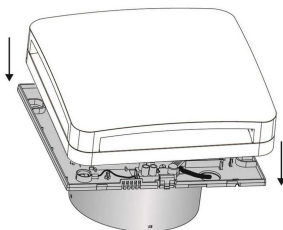

UNICO C – ALBA - ONDA

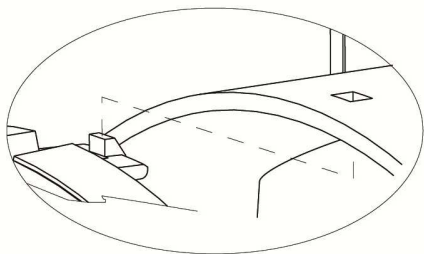
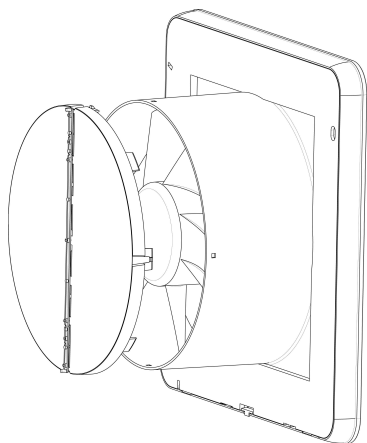

Serranda

Shutter

Volet

Verschloßklappe

Ø10 0080100

Sluiter

Ø12 0080300

Persiana

Registo

ΠΕΡΣΙΔΑ

ИНЕРЦ ИОНАЯ РЕШЁТКА

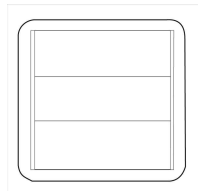

Griglia esterna

External grille

Grille extérieure

Außen-

Ø10 0080000

Lüftungsgitter

Ø12 0080200

Buitenrooster

Ø15 0090700

Rejilla exterior

Grelha externa

ΕΞΩΤΕΡΚΗ ΓΡΙΑΛΙΑ

НАРУЖНАЯ РЕШЁТКА



Kit vetro*

Glass kit*

Fensterkit*

Ø10 0059100

Set voor raammontage*

Ø12 0059200

Kit para ventana*

Ø15 0059300

Kit de janela*

Κίτ τζαμού *

АДАПТЕР ДЛЯ *

ОКОННОГО МОНТАЖА

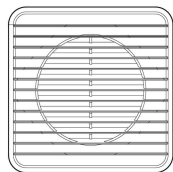

*Only for IN series

EP S.p.A.

Via del Commercio, 1 - 25039 - Travagliato (BS)

Tel. 030 68 62 341 - E-mail oerre@oerre.it

www.oerre.it