

SERVICE MANUAL

R410A

[Model Name]

[Service Ref.]

PUHZ-SHW230YKA2

PUHZ-SHW230YKA2
PUHZ-SHW230YKA2R1
PUHZ-SHW230YKA2R2

Revision:

- Added
PUHZ-SHW230YKA2R2
in REVISED EDITION-B.
- Some descriptions have
been modified.

OCH594 REVISED EDITION-A
is void.

Note:

- This manual describes
service data of the outdoor
unit only.

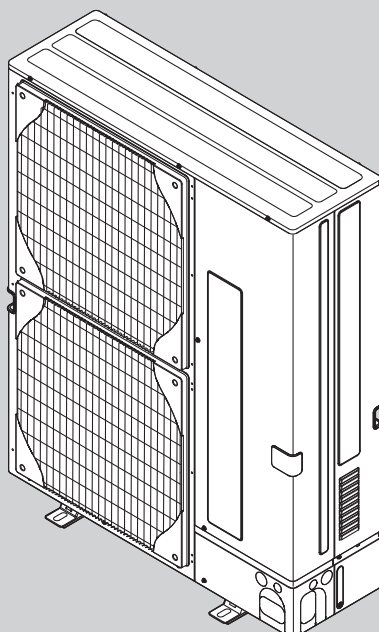

CONTENTS

TECHNICAL CHANGES.....	2
1. SAFETY PRECAUTION.....	3
2. SPECIFICATIONS.....	5
3. DATA	7
4. OUTLINES AND DIMENSIONS.....	9
5. WIRING DIAGRAM.....	10
6. WIRING SPECIFICATIONS	12
7. REFRIGERANT SYSTEM DIAGRAM	14
8. TROUBLESHOOTING	15
9. DISASSEMBLY PROCEDURE	57
PARTS CATALOG (OCB594)	

TECHNICAL CHANGES

Service ref. have been changed as follows.

PUHZ-SHW230YKA2 → PUHZ-SHW230YKA2R1

- A compliance with ErP directive Lot6 has been authorized.

PUHZ-SHW230YKA2R1 → PUHZ-SHW230YKA2R2

- Power board, controller board and noise filter board have been changed.
- Quantity of refrigerant has been changed.
- Unit weight has been changed.

1

SAFETY PRECAUTION

1-1. ALWAYS OBSERVE FOR SAFETY

Before obtaining access to terminal, all supply circuits must be disconnected.

Preparation before the repair service.

- Prepare the proper tools.
- Prepare the proper protectors.
- Provide adequate ventilation.
- After stopping the operation of the air conditioner, turn off the power-supply breaker.
- Discharge the condenser before the work involving the electric parts.

Precautions during the repair service.

- Do not perform the work involving the electric parts with wet hands.
- Do not pour water into the electric parts.
- Do not touch the refrigerant.
- Do not touch the hot or cold areas in the refrigerating cycle.
- When the repair or the inspection of the circuit needs to be done without turning off the power, exercise great caution not to touch the live parts.

1-2. CAUTIONS RELATED TO NEW REFRIGERANT

Cautions for units utilizing refrigerant R410A

Do not use refrigerant other than R410A.

If other refrigerant (R22, etc.) is used, chlorine in refrigerant can cause deterioration of refrigerant oil, etc.

Use a vacuum pump with a reverse flow check valve.

Vacuum pump oil may flow back into refrigerant cycle and that can cause deterioration of refrigerant oil, etc.

Use the following tools specifically designed for use with R410A refrigerant.

The following tools are necessary to use R410A refrigerant.

Tools for R410A	
Gauge manifold	Vacuum pump adaptor
Charge hose	Electronic refrigerant charging scale
Gas leak detector	
Torque wrench	

Handle tools with care.

If dirt, dust or moisture enters into refrigerant cycle, that can cause deterioration of refrigerant oil or malfunction of compressor.

Do not use a charging cylinder.

If a charging cylinder is used, the composition of refrigerant will change and the efficiency will be lowered.

Charge refrigerant from liquid phase of gas cylinder.

If the refrigerant is charged from gas phase, composition change may occur in refrigerant and the efficiency will be lowered.

Use the specified refrigerant only.

Never use any refrigerant other than that specified. Doing so may cause a burst, an explosion, or fire when the unit is being used, serviced, or disposed of. Correct refrigerant is specified in the manuals and on the spec labels provided with our products. We will not be held responsible for mechanical failure, system malfunction, unit breakdown or accidents caused by failure to follow the instructions.

Ventilate the room if refrigerant leaks during operation. If refrigerant comes into contact with a flame, poisonous gases will be released.

[1] Cautions for service

- (1) Perform service after recovering the refrigerant left in unit completely.
- (2) Do not release refrigerant in the air.
- (3) After completing service, charge the cycle with specified amount of refrigerant.

[2] Additional refrigerant charge

When charging directly from cylinder

- Check that cylinder for R410A on the market is a syphon type.
- Charging should be performed with the cylinder of syphon stood vertically. (Refrigerant is charged from liquid phase.)

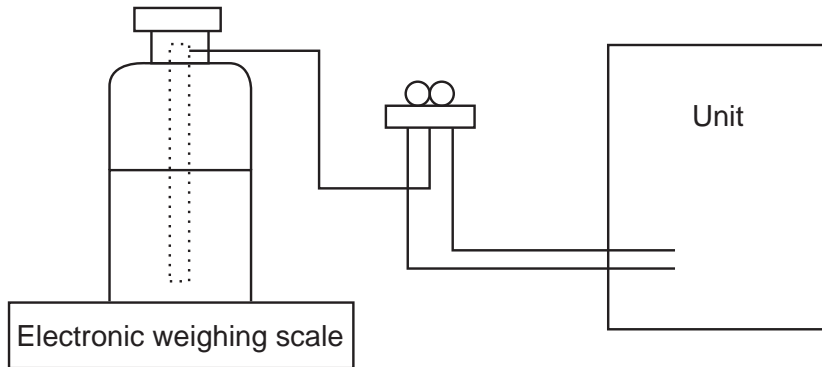

[3] Service tools

Use the below service tools as exclusive tools for R410A refrigerant.

No.	Tool name	Specifications
①	Gauge manifold	<ul style="list-style-type: none"> · Only for R410A · Use the existing fitting specifications. (UNF1/2) · Use high-tension side pressure of 5.3 MPa·G or over.
②	Charge hose	<ul style="list-style-type: none"> · Only for R410A · Use pressure performance of 5.09 MPa·G or over.
③	Electronic weighing scale	—
④	Gas leak detector	· Use the detector for R134a, R407C or R410A.
⑤	Adaptor for reverse flow check	· Attach on vacuum pump.
⑥	Refrigerant charge base	—
⑦	Refrigerant cylinder	<ul style="list-style-type: none"> · Only for R410A Top of cylinder (Pink) Cylinder with syphon
⑧	Refrigerant recovery equipment	—

1-3. CAUTIONS FOR REFRIGERANT PIPING WORK

Tools for R410A (The following table shows whether conventional tools can be used or not.)

Tools and materials	Use	R410A tools	Can R22 tools be used?	Can R407C tools be used?
Gauge manifold	Air purge, refrigerant charge and operation check	Tool exclusive for R410A	×	×
Charge hose		Tool exclusive for R410A	×	×
Gas leak detector	Gas leak check	Tool for HFC refrigerant	×	○
Refrigerant recovery equipment	Refrigerant recovery	Tool exclusive for R410A	×	×
Refrigerant cylinder	Refrigerant charge	Tool exclusive for R410A	×	×
Safety charger	Prevent compressor malfunction when charging refrigerant by spraying liquid refrigerant	Tool exclusive for R410A	×	×
Charge valve	Prevent gas from blowing out when detaching charge hose	Tool exclusive for R410A	×	×
Vacuum pump	Vacuum drying and air purge	Tools for other refrigerants can be used if equipped with adapter for reverse flow check	Δ(Usable if equipped with adapter for reverse flow)	Δ(Usable if equipped with adapter for reverse flow)
Bender	Bend the pipes	Tools for other refrigerants can be used	○	○
Pipe cutter	Cut the pipes	Tools for other refrigerants can be used	○	○
Welder and nitrogen gas cylinder	Weld the pipes	Tools for other refrigerants can be used	○	○
Refrigerant charging scale	Charge refrigerant	Tools for other refrigerants can be used	○	○
Vacuum gauge or thermistor vacuum gauge and vacuum valve	Check the degree of vacuum. (Vacuum valve prevents back flow of oil and refrigerant to thermistor vacuum gauge)	Tools for other refrigerants can be used	○	○
Charging cylinder	Refrigerant charge	Tool exclusive for R410A	×	-

x: Prepare a new tool. (Use the new tool as the tool exclusive for R410A.)

Δ: Tools for other refrigerants can be used under certain conditions.

○: Tools for other refrigerants can be used.

2-1. SPECIFICATION

2-1-1. PUHZ-SHW230YKA2

<Reference data> Plate heat exchanger (MWA2-38PA) *2 pcs [connected in parallel]

Nominal water flow			L/min	65.9
Heating (A7/W35)	Capacity	kW	23.0	
	COP		3.65	
	Power input	kW	6.31	
Heating (A7/W45)	Capacity	kW	23.0	
	COP		3.02	
	Power input	kW	7.62	
Heating (A2/W35)	Capacity	kW	23.0	
	COP		2.37	
	Power input	kW	9.71	
Heating (A2/W45)	Capacity	kW	22.9	
	COP		2.02	
	Power input	kW	11.32	
Nominal water flow			L/min	57.3
Cooling (A35/W7)	Capacity	kW	20.00	
	EER		2.22	
	Power input	kW	9.01	
Cooling (A35/W18)	Capacity	kW	20.00	
	EER		3.55	
	Power input	kW	5.63	

Rating conditions	
Nominal operating condition	
Heating (A2/W35)	
Outside air temperature (Dry-bulb)	+ 2°C
Outside air temperature (Wet-bulb)	+ 1°C
Water temperature (inlet/outlet)	+ 30°C/+ 35°C
Heating (A2/W45)	
Outside air temperature (Dry-bulb)	+ 2°C
Outside air temperature (Wet-bulb)	+ 1°C
Water temperature (inlet/outlet)	+ 40°C/+ 35°C
Heating (A7/W35)	
Outside air temperature (Dry-bulb)	+ 7°C
Outside air temperature (Wet-bulb)	+ 6°C
Water temperature (inlet/outlet)	+ 30°C/+ 35°C
Heating (A7/W45)	
Outside air temperature (Dry-bulb)	+ 7°C
Outside air temperature (Wet-bulb)	+ 6°C
Water temperature (inlet/outlet)	+ 40°C/+ 45°C
Cooling (A35/W7)	
Outside air temperature (Dry-bulb)	+ 35 °C
Outside air temperature (Wet-bulb)	+ 24 °C
Water temperature (inlet/outlet)	+ 12 °C/+ 7 °C
Cooling (A35/W18)	
Outside air temperature (Dry-bulb)	+ 35°C
Outside air temperature (Wet-bulb)	+ 24°C
Water temperature (inlet/outlet)	+ 23°C/+ 18°C

Note: "COP" and "Power input" in the above table are the values that do **NOT** contain the "pump input (based on EN 14511)".

2-1-2. Outdoor unit

Service Ref.			PUHZ-SHW230YKA2 PUHZ-SHW230YKA2R1	PUHZ-SHW230YKA2R2
Running current	Heating(A7/W35)	A	9.6	
	Cooling(A35/W7)	A	9.6	
Power factor	Heating(A7/W35)	%	95	
	Cooling(A35/W7)	%	95	
Power supply (phase, voltage, cycle)			3 phase, 400 V, 50 Hz	
Max. current		A	26.0	20
Breaker size		A	32	25
Outer casing			Galvanized plate	
External finish			Munsell 3Y 7.8/1.1	
Refrigerant control			Liner expansion valve	
Compressor			Hermetic scroll	
	Model		ANB66FJNMT	
	Motor output	kW	4.7	
	Start type		Inverter	
	Protection devices		HP switch LP switch Discharge thermo Overcurrent detection Comp. surface thermo	
	Oil (Model)	L	1.7 (FV50S)	
Crankcase heater			—	
Heat exchanger	Air		Plate fin coil	
	Water		Plate heat exchanger	
Fan	Fan (drive) x No.		Propeller fan x 2	
	Fan motor output	kW	0.150 x 2	
	Airflow	m ³ /min (CFM)	140 (4,940)	
Defrost method			Reverse cycle *1	
Noise level (SPL)	Heating	dB	59 *2 *5	
	Cooling	dB	58 *2	
Noise level (PWL)	Heating	dB	75	
Dimensions	Width	mm (in)	1050 (41-5/16)	
	Depth	mm (in)	330 + 30(*3) (13+1-3/16)	
	Height	mm (in)	1338 (52-11/16)	
Weight		kg (lbs)	149 (328)	143 (315)
Refrigerant			R410A	
	Quantity	kg (lbs)	7.7 (17.0)	7.1 (15.7)
Guaranteed operating range (Outdoor)	Heating	°C	-25(*6) to +21	
	DHW	°C	-25 to +35	
	Cooling	°C	-5(*4) to +46	
Outlet water temp. (Max. in heating, Min. in cooling)	Heating	°C	+60	
	Cooling	°C	+5	
Nominal return water temperature range	Heating	°C	+10 to +59	
	Cooling	°C	+8 to +28	
Water flow rate range		L/min	28.7 to 65.9	

*1 Hot gas with 4-way valve

*2 At distance of 1 m from outdoor unit

*3 grill

*4 With the optional air outlet guide, the operation at -15°C outdoor temperature is possible.

*5 A weighted sound power level in accordance with ISO9614-1 for EN14511 testing is 75 dBA.

*6 Lower limit of use is -5°C for EN14511 testing purpose.

Nominal operating condition	
Heating(A7/W35)	
Outside air temperature (Dry-bulb)	+7°C
Outside air temperature (Wet-bulb)	+6°C
Water temperature (inlet/outlet)	+30/+35°C
Cooling(A35/W7)	
Outside air temperature (Dry-bulb)	+35°C
Outside air temperature (Wet-bulb)	+24°C
Water temperature (inlet/outlet)	+12/+7°C

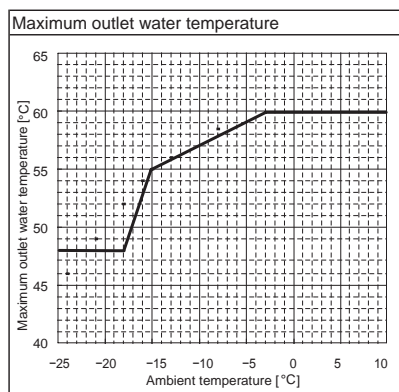

3

DATA

3-1. Additional refrigerant charge (R410A)

Service Ref.	Initial charge (kg)	Operation method	Liquid pipe size	Total piping length (one way)							
				Amount of additional refrigerant charge (kg)							
				2 - 10 m	11 - 20 m	21 - 30 m	31 - 40 m	41-50 m	51-60 m	61-70 m	71-80 m
PUHZ-SHW230YKA2 PUHZ-SHW230YKA2R1	7.7	ATW/ATA/ AHU	-	-	-	-	1.2	2.4	3.6	4.8	5.2
PUHZ-SHW230YKA2R2*1	7.1	ATW	ø12.7	-	-	-	1.4	2.8	4.2	5.6	7.0
			ø9.52	-	-	-	-	0.8	1.7	2.6	3.5
		ATA/AHU	ø12.7	-	-	1.4	2.8	4.2	5.6	7.0	8.4
			ø9.52	-	-	-	0.8	1.7	2.6	3.5	4.4

*1 Set the SW8-2 on controller board ON when the piping length is 10 m or less. (for models from PUHZ-SHW230YKA2R2)

3-2. Recharge refrigerant amount (R410A)

Service Ref.	Operation method	Liquid pipe size	Total piping length (one way)							
			Amount of recharge refrigerant (kg)							
			2 - 10 m	11 - 20 m	21 - 30 m	31 - 40 m	41-50 m	51-60 m	61-70 m	71-80 m
PUHZ-SHW230YKA2 PUHZ-SHW230YKA2R1	ATW/ATA/ AHU	ø12.7	5.5	6.6	7.7	8.9	10.1	11.3	12.5	12.9
ø9.52		5.4	6.3	6.7	8.3	9.4	10.4	11.5	11.8	
PUHZ-SHW230YKA2R2*1	ATW	ø12.7	5.9	6.5	7.1	8.5	9.9	11.3	12.7	14.1
		ø9.52	5.7	6.1	6.5	7.1	7.9	8.8	9.7	10.6
	ATA/AHU	ø12.7	6.5	7.1	8.5	9.9	11.3	12.7	14.1	15.5
		ø9.52	6.1	6.5	7.1	7.9	8.8	9.7	10.6	11.5

*1 Set the SW8-2 on controller board ON when the piping length is 10 m or less. (for models from PUHZ-SHW230YKA2R2)

3-3. NOISE CRITERION CURVES

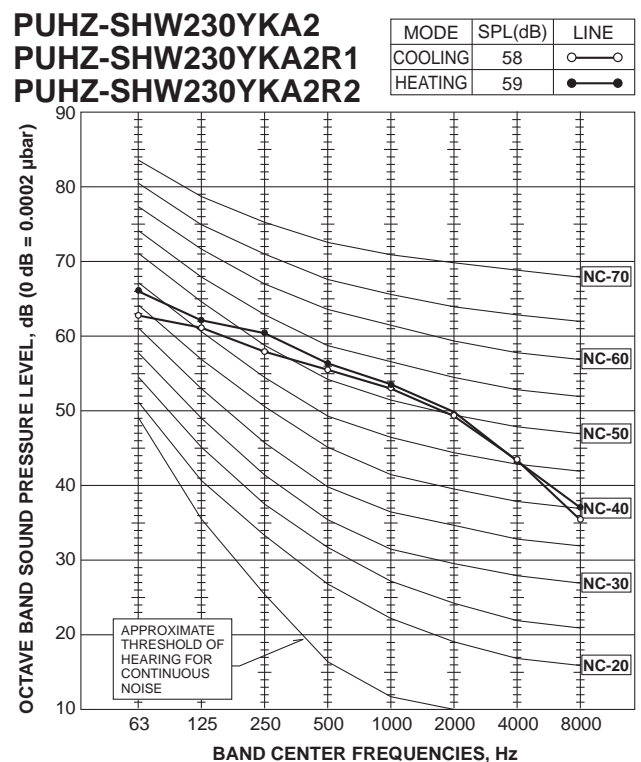
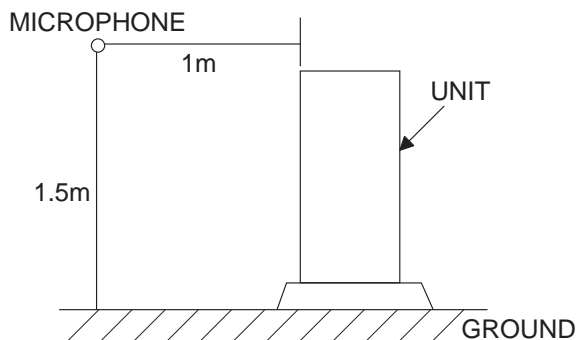

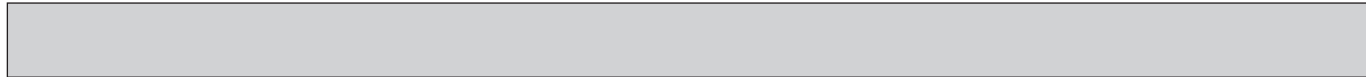

3-4. Standard operation data

Reference data (connect to Plate HEX)

			(MWA2-38PA) × 2 pcs [connected in parallel]	
Mode			Cooling (A35/W7)	Heating (A7/W35)
Total	Capacity	W	20,000	23,000
	Input	kW	9.01	6.31
Electrical circuit	Outdoor unit		PUHZ-SHW230YKA2	
	Phase, Hz		3, 50	
	Voltage	V	400	
	Current	A	13.7	9.6
Refrigerant circuit	Discharge pressure	MPa	3.0	2.0
	Suction pressure	MPa	0.7	0.6
	Discharge temperature	°C	79	73
	Condensing temperature	°C	49	35
	Suction temperature	°C	8	8
	Evaporating temperature	°C	6	2
	Evaporator inlet temperature	°C	7	—
	Evaporator outlet temperature	°C	6	—
	Condenser inlet temperature	°C	—	65
	Condenser outlet temperature	°C	—	34
Water conditions	Flow volume	L/min	57.3	65.9
	Outlet water temperature	°C	7	35
Outdoor conditions	Intake air temperature	D.B. °C	35	7
		W.B. °C	24	6

Piping length : Main 2.5 m, Branch 2.5 m/2.5 m

The unit of pressure has been changed to MPa based on international SI system.

The conversion factor is: 1 (MPa) = 10.2 (kgf/cm²)

3-5. CAPACITY CORRECTION (Refrigerant piping length)

Cooling and heating capacity is lowered according to the piping length. Capacity can be obtained by referring to the following capacity curves.

Corrected pipe length (m) = actual pipe length (m) + number of bends × 0.3 (m)

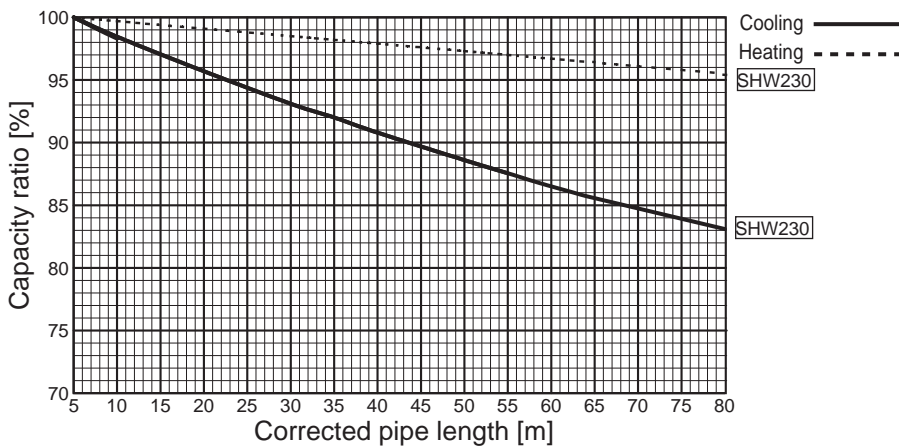

PUHZ-SHW230YKA2
 PUHZ-SHW230YKA2R1
 PUHZ-SHW230YKA2R2

Unit: mm

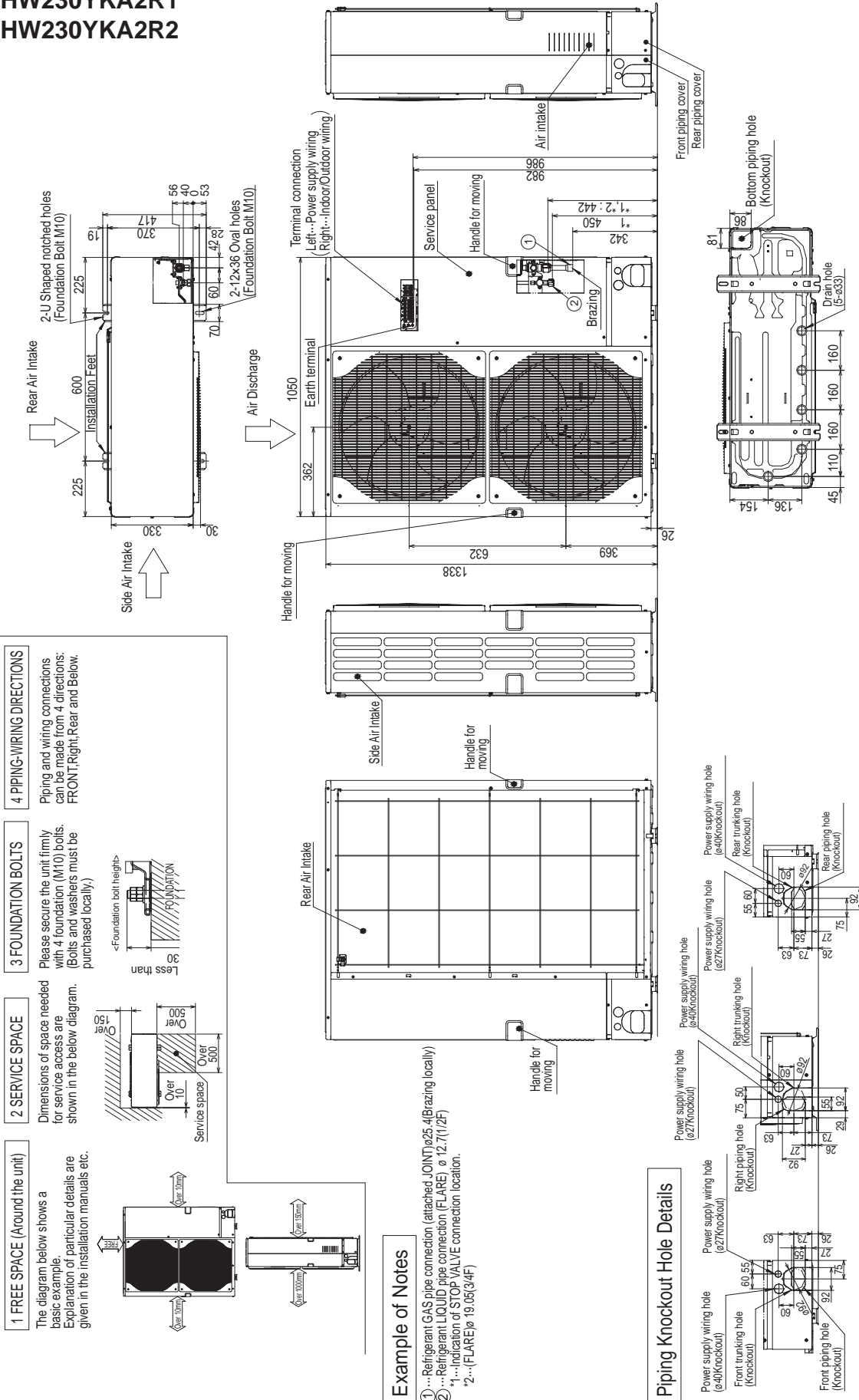

PUHZ-SHW230YKA2

PUHZ-SHW230YKA2R1

SYMBOL	NAME	SYMBOL	NAME	SYMBOL	NAME
TB1	Terminal Block<Power Supply>	LEV-A, LEV-B, LEV-C	Linear Expansion Valve	SW6	Switch<Model Select>
TB2	Terminal Block<Indoor/Outdoor>	ACL4	Reactor	SW7	Switch<Function Switch>
MC	Motor for Compressor	DCL	Reactor	SW8	Switch<Function Switch>
MF1, MF2	Fan Motor	CB1, CB2	Main Smoothing Capacitor	SW9	Switch<Function Switch>
21S4	Solenoid Valve (4-Way Valve)	RS	Rush Current Protect Resistor	SWP	Switch<Pump Down>
63H	High Pressure Switch	FUSE1, FUSE2	Fuse<T15AL250V>	CN31	Connector<Emergency Operation>
63L	Low Pressure Switch	CY1, CY2	Capacitor	F3, F4	Fuse<T6.3AL250V>
63HS	High Pressure Sensor	P. B.	Power Circuit Board	SV1/CH	Connector<Connection for Option>
TH3	Thermistor<Liquid>	N. F.	Noise Filter Circuit Board	SV3/SS	Connector<Connection for Option>
TH4	Thermistor<Discharge>	C. B.	Controller Circuit Board	CNM	Connector<Connection for Option>
TH6	Thermistor<2-Phase Pipe>	SW1	Switch<Manual Defrost, Defect History Record Reset, Refrigerant Address>	CNMNT	Connector<Connection for Option>
TH7	Thermistor<Ambient>	SW4	Switch<Test Operation>	CNMNT	Connector<Connection for Option>
TH32	Thermistor<Suction>	SW5	Switch<Function Switch, Model Select>	CNDM	Connector<Connection for Option>
TH34	Thermistor<Comp. Surface>				

★1 MODEL SELECT
The black square (■) indicates a switch position.

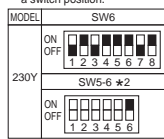

★2 SW5 -1 to 5 : Function Switch.

★3 Ambient temp. of ZUBADAN Flash Injection becomes effective.
The black square (■) indicates a switch position.

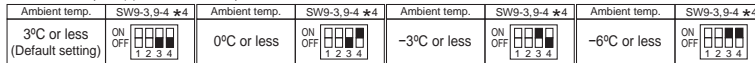

★4 SW9-1 to 2 : Function Switch

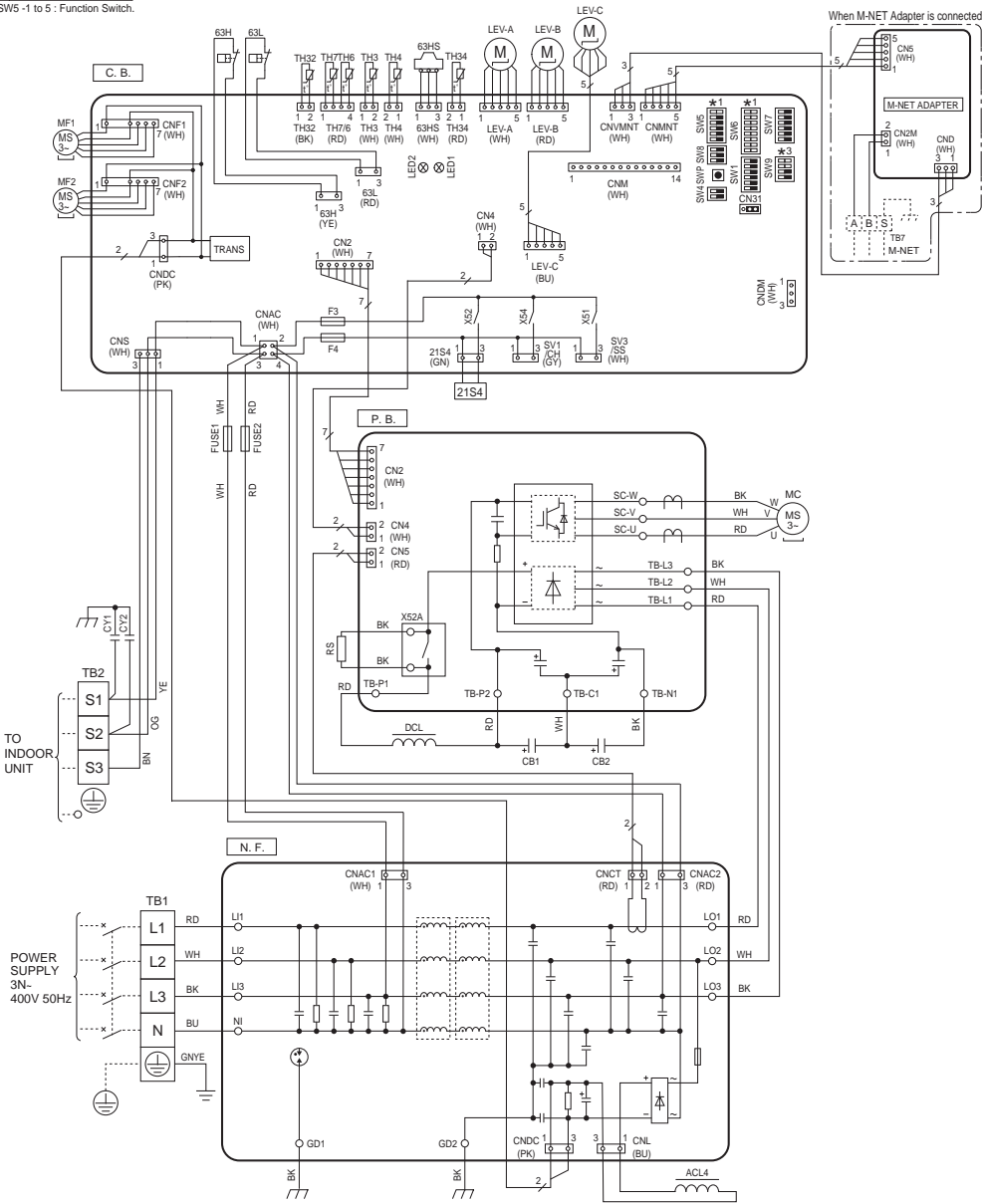

PUHZ-SHW230YKA2R2

SYMBOL	NAME	SYMBOL	NAME	SYMBOL	NAME
TB1	Terminal Block (Power Supply)	TH34	Thermistor (Comp. Surface)	SW5	Switch (Function Switch, Model Select)
TB2	Terminal Block (Indoor/Outdoor)	LEV-A, LEV-B, LEV-C	Linear Expansion Valve	SW6	Switch (Model Select)
MC	Motor for Compressor	ACL4	Reactor	SW7	Switch (Function Switch)
MF1, MF2	Fan Motor	DCL	Reactor	SW8	Switch (Function Switch)
21S4	Solenoid Valve (4-Way Valve)	RS	Flush Current Protect Resistor	SW9	Switch (Function Switch)
63H	High Pressure Switch	FUSE1, FUSE2	Fuse (T15AL250V)	SWP	Switch (Pump Down)
63L	Low Pressure Switch	CY1, CY2	Capacitor	CN31	Connector (Emergency Operation)
63HS	High Pressure Sensor	P. B.	Power Circuit Board	F3, F4	Fuse (T6,3AL250V)
TH3	Thermistor (Liquid)	N. F.	Noise Filter Circuit Board	SV1, CH	Connector (Connection for Option)
TH4	Thermistor (Discharge)	F1	Fuse (T6,3A L250V)	SV3, SS	Connector (Connection for Option)
TH6	Thermistor (2-Phase Pipe)	C. B.	Controller Circuit Board	CNM	Connector (Connection for Option)
TH7	Thermistor (Ambient)	SW1	Switch (Manual Defrost, Defect History Record Reset, Refrigerant Address)	CNMNT	Connector (Connection for Option)
TH8	Thermistor (HEAT Sink)	SW4	Switch (Function Switch)	CNVWNT	Connector (Connection for Option)
TH32	Thermistor (Suction)			CNDM	Connector (Connection for Option)

*1 MODEL SELECT
The black square (■) indicates a switch position.

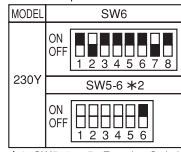

*2 SW5-1 to 5 : Function Switch.

*3 Ambient temp. of ZUBADAN Flash Injection becomes effective.
The black square (■) indicates a switch position.

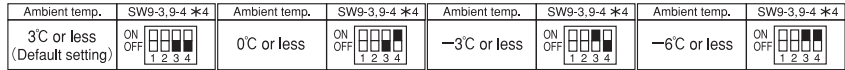

*4 SW9-1 to 2 : Function Switch

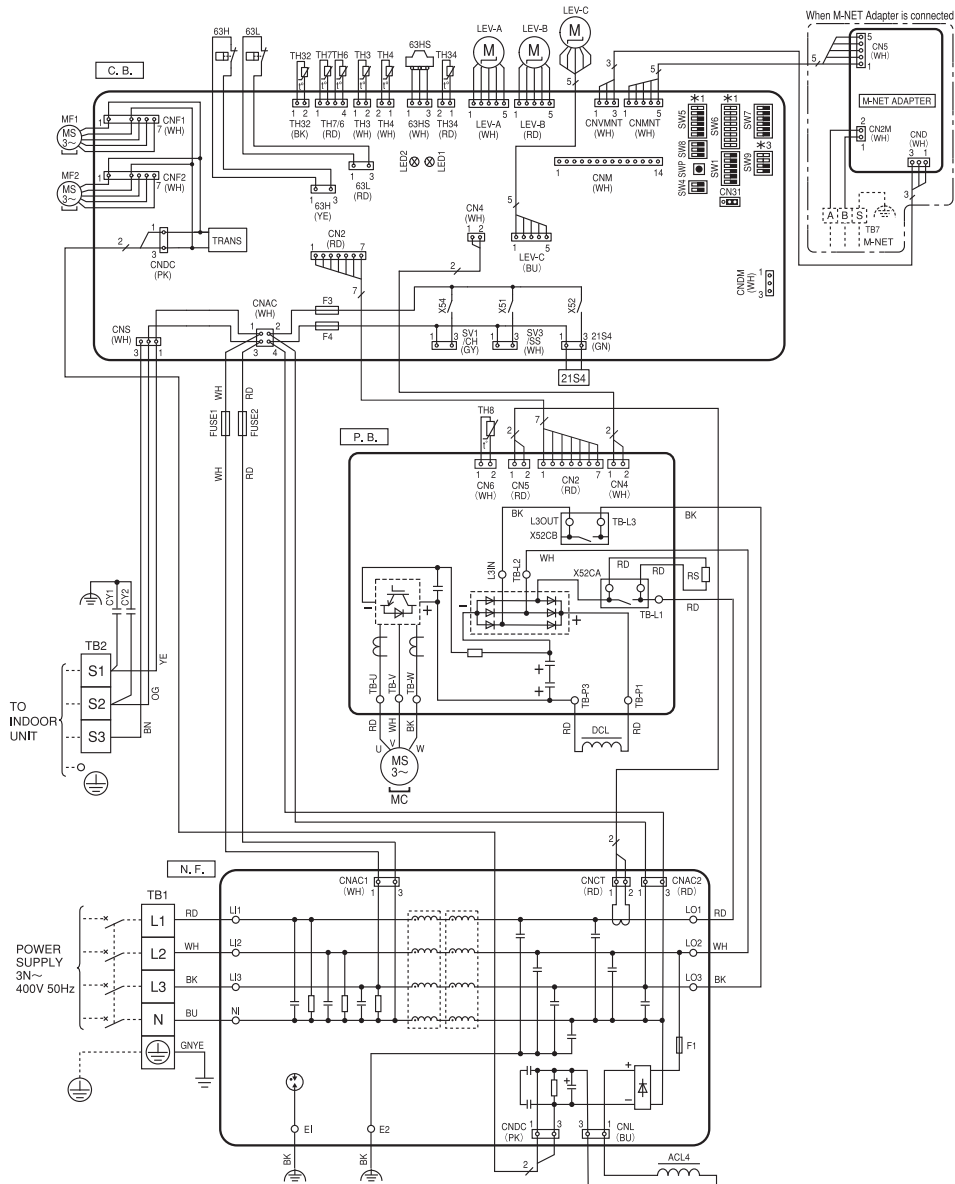

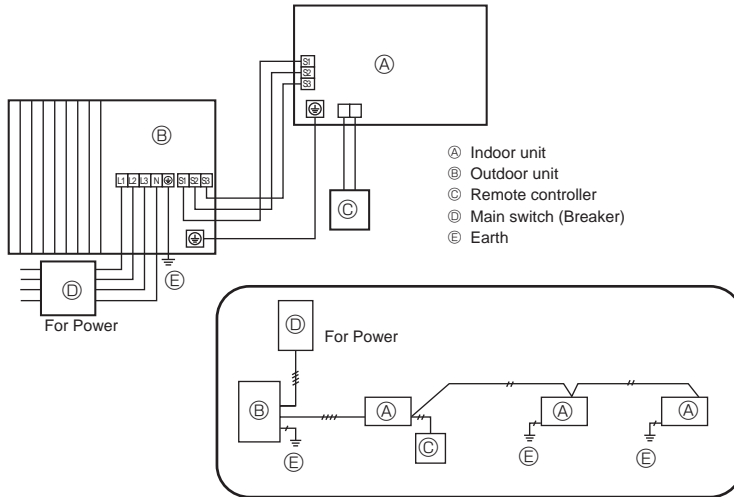

Twin or triple system construction of the hydrobox is not allowed.
 When the hydrobox is constructed as a slave, remote controller must be connected by crossover wiring.

Note: When multiple indoor units (hydroboxes) are connected to the outdoor unit, wire the PCB of either one of the indoor unit and the outdoor unit (S1,S2,S3).
 It is impossible to connect the PCBs of multiple indoor units to the outdoor unit.

FIELD ELECTRICAL WIRING (power wiring specifications)

Outdoor unit model			SHW230Y
Outdoor unit power supply			3N~ (3 ph 4-wires), 50 Hz, 400 V
Outdoor unit input capacity Main switch (Breaker)		*1	YKA2/YKA2R1: 32 A YKA2R2: 25A
Wiring Wire No. x size (mm ²)	Outdoor unit power supply		5 x Min. 4
	Indoor unit-Outdoor unit	*2	Cable length 50 m: 3x4 (Polar)/ Cable length 80 m: 3x6 (Polar)
	Indoor unit-Outdoor unit earth	*2	1 x Min. 2.5
	Remote controller-Indoor unit	*3	2 x 0.3 (Non-polar)
Circuit rating	Outdoor unit L-N (single)	*4	230 V AC
	Outdoor unit L1-N, L2-N, L3-N (3 phase)		230 V AC
	Indoor unit-Outdoor unit S1-S2	*4	230 V AC
	Indoor unit-Outdoor unit S2-S3	*4	24 V DC
	Remote controller-Indoor unit	*4	12 V DC

*1. A breaker with at least 3.0 mm contact separation in each poles shall be provided. Use earth leakage breaker (NV).
 Make sure that the current leakage breaker is one compatible with higher harmonics.

Always use a current leakage breaker that is compatible with higher harmonics as this unit is equipped with an inverter.
 The use of an inadequate breaker can cause the incorrect operation of inverter.

*2. Maximum 80 m. Total maximum including all indoor/outdoor connection is 80 m.
 • Use one cable for S1 and S2 and another for S3 as shown in the picture.



*3. The 10 m wire is attached in the remote controller accessory.

*4. The figures are NOT always against the ground.

S3 terminal has 24 V DC against S2 terminal. However between S3 and S1, these terminals are NOT electrically insulated by the transformer or other device.

- Notes:**
1. Wiring size must comply with the applicable local and national code.
 2. Power supply cords and Indoor/Outdoor unit connecting cords shall not be lighter than polychloroprene sheathed flexible cord. (Design 60245 IEC 57)
 3. Use an earth wire which is longer than the other cords so that it will not become disconnected when tension is applied.



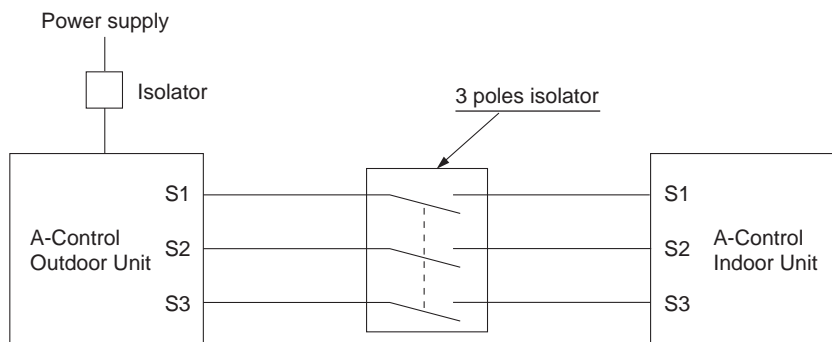

⚠ Caution: Be sure to install N-line. Without N-line, it could cause damage to the unit.



⚠ Warning:

- In case of A-control wiring, there is high voltage potential on the S3 terminal caused by electrical circuit design that has no electrical insulation between power line and communication signal line. Therefore, please turn off the main power supply when servicing. And do not touch the S1, S2, S3 terminals when the power is energized. If isolator should be used between indoor unit and outdoor unit, please use 3-pole type.
- Turn on the main power when the ambient temperature is -20°C or higher.
- In below -20°C condition, it needs at least 12 hrs standby to operate in order to warm the electrical parts.

INDOOR-OUTDOOR CONNECTING CABLE

Cross section of cable	Wire size (mm ²)	Number of wires	Polarity	L (m) ^{*5}
Round 	2.5	3	Clockwise : S1-S2-S3 (Pay attention to stripe of yellow and green.)	(30) ^{*1}
Flat 	2.5	3	Not applicable (Since center wire has no cover finish.)	Not applicable ^{*4}
Flat 	1.5	4	From left to right: S1-Open-S2-S3	(18) ^{*2}
Round 	2.5	4	Clockwise : S1-S2-S3-Open (Connect S1 and S3 to the opposite angle.)	(30) ^{*3}

Note: Power supply cords of appliances shall not be lighter than design 60245 IEC or 227 IEC.

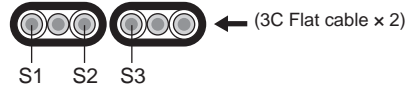

- *1 In case that cable with stripe of yellow and green is available.
- *2 In case of regular polarity connection (S1-S2-S3), wire size is 1.5 mm².
- *3 In case of regular polarity connection (S1-S2-S3).
- *4 In the flat cables are connected as this picture, they can be used up to 30 m.
- *5 Mentioned cable length is just a reference value.
It may be different depending on the condition of installation, humidity or materials, etc.

Be sure to connect the indoor-outdoor connecting cables directly to the units (no intermediate connections). Intermediate connections can lead to communication error if water enters the cables and causes insufficient insulation to ground or a poor electrical contact at the intermediate connection point.

PUHZ-SHW230YKA2

PUHZ-SHW230YKA2R1

PUHZ-SHW230YKA2R2

<Reference> System example: Plate HEX (MWA2 * 2 pcs) + FTC (TH1/2)

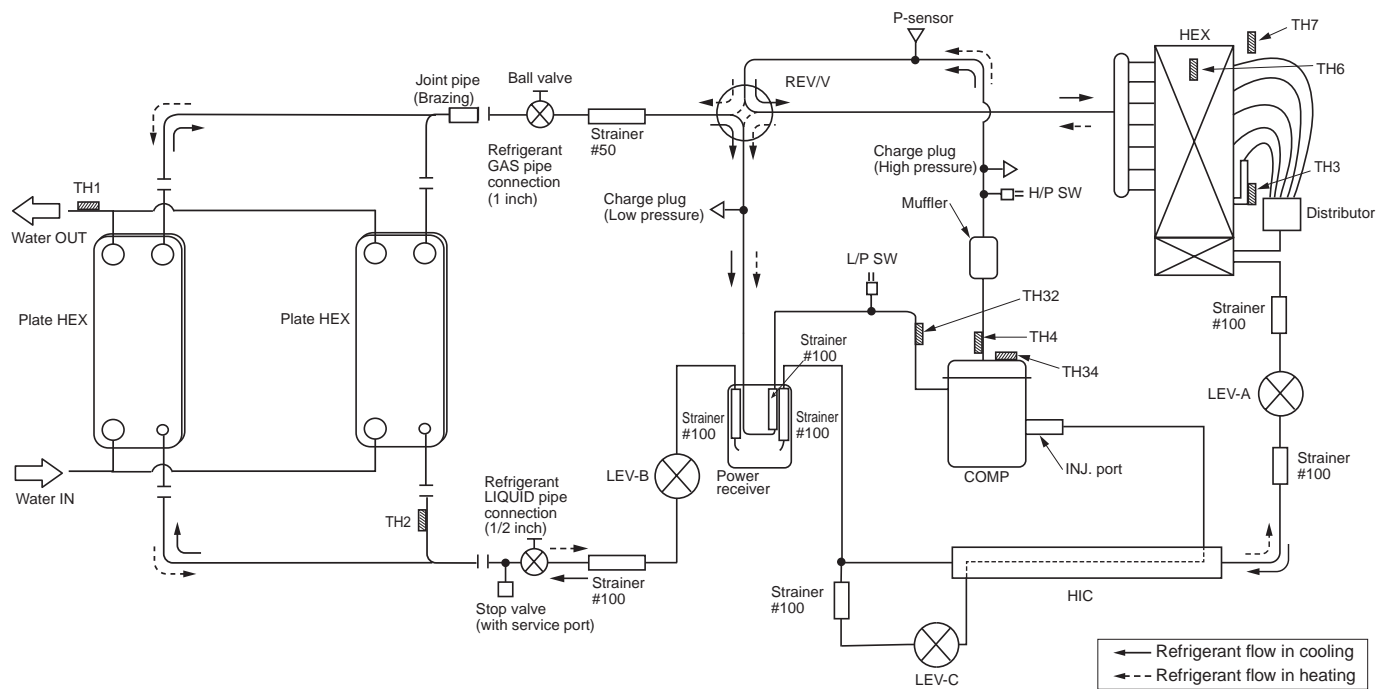

Symbol	Part name	Detail	
COMP	Compressor	DC inverter scroll compressor (Mitsubishi Electric Corporation)	
INJ. port	Compressor Injection port		
Muffler	Discharge muffler		
HEX	Heat exchanger		
H/P SW	High pressure switch (63H)	For protection (OFF: 4.15MPa)	
L/P SW	Low pressure switch (63L)	For protection (OFF: -0.03MPa)	
REV/V	Reversing (4-way) valve (21S4)	Change the refrigerant circuit (Heating / Cooling) and for Defrosting	
CHECK/V	Check valve		
P-Sensor	Pressure sensor (63HS)	For calculation of the condensing temperature from high pressure	
LEV-A	Linear expansion valve -A	Heating:Secondary LEV Cooling:Primary LEV	
LEV-B	Linear expansion valve -B	Heating:Primary LEV Cooling:Secondary LEV	
LEV-C	Linear expansion valve -C	For HIC (heating only)	
TH32	Suction temperature thermistor	For LEV control	
TH3	Liquid temperature thermistor	Heating:Evaporating temperature Cooling:Sub cool liquid temperature	
TH4	Discharge temperature thermistor	For LEV control and for compressor protection	
TH6	2-phase pipe temperature thermistor	Outdoor 2-phase pipe temperature	
TH7	Ambient temperature thermistor	For fan control and for compressor frequency control	
TH8	Heat sink temperature		
TH34	Comp. surface temperature thermistor	For protection	
Power Receiver	Power Receiver	For accumulation of refrigerant	
HIC	Heat interchange circuit	For high heating capacity	
Plate HEX	Plate Heat Exchanger	MWA2-38PA (MITSUBISHI)	<Reference> System example
TH1	Outlet water temperature thermistor	For flow temp. controller	
TH2	Liquid pipe temperature thermistor	For flow temp. controller	

8-1. TROUBLESHOOTING

<Check code displayed by self-diagnosis and actions to be taken for service (summary)>

Present and past check codes are logged, and they can be displayed on the control board of outdoor unit. Actions to be taken for service, which depends on whether or not the trouble is reoccurring in the field, are summarized in the table below. Check the contents below before investigating details.

Unit conditions at service	Check code	Actions to be taken for service (summary)
The trouble is reoccurring.	Displayed	Judge the problem and take a corrective action according to "8-3. SELF-DIAGNOSIS ACTION TABLE".
	Not displayed	Conduct troubleshooting and ascertain the cause of the trouble.
The trouble is not reoccurring.	Logged	<ul style="list-style-type: none"> ① Consider the temporary defects such as the work of protection devices in the refrigerant circuit including compressor, poor connection of wiring, noise, etc. Re-check the symptom, and check the installation environment, refrigerant amount, weather when the trouble occurred, matters related to wiring, etc. ② Reset check code logs and restart the unit after finishing service. ③ There is no abnormality in electrical component, controller board, etc.
	Not logged	<ul style="list-style-type: none"> ① Re-check the abnormal symptom. ② Conduct troubleshooting and ascertain the cause of the trouble. ③ Continue to operate unit for the time being if the cause is not ascertained. ④ There is no abnormality concerning of parts such as electrical component, controller board, etc.

8-2. CHECKPOINT UNDER TEST RUN

Before test run

- After installation of outdoor unit, piping work and electric wiring work, re-check that there is no water leakage, loosened connections and incorrect polarity.
- Measure impedance between the ground and the power supply terminal block (L, N) on the outdoor unit by 500 V Megger and check that it is 1.0 MΩ or over.
- Turn on power supply 12 hours before test run in order to protect compressor.
- Make sure to read operation manual before test run. (Especially items to secure safety.)

Warning:

Do not use the system if the insulation resistance is less than 1.0 MΩ.

Caution:

Do not carry out this test on the control wiring (low voltage circuit) terminals.

Self-check

- ① Turn on the power.
- ② Press [CHECK] button twice.
- ③ Press [CHECK] button twice to finish self-check.
 - Ⓐ CHECK button Ⓑ IC : Interface or FTC unit Ⓒ OC : Outdoor unit Ⓓ Check code

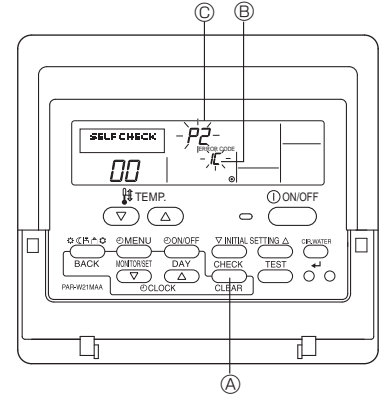

Check code	Symptom
P1	Flow water (TH1) sensor error
P2	Refrigerant liquid Pipe (TH2) sensor error
P6	Freezing/Overheating protection operation
P9	Actual tank temp. (TH5)/ (THW5 for FTC2B) sensor error
Fb	FTC unit control system error (memory error, etc.)
E0–E5	Signal transmission failure between remote controller and FTC.
E6–EF	Signal transmission failure between outdoor unit and FTC.
----	No trouble generated in the past.
FFFF	No corresponding unit
U*, F*	Outdoor unit failure. Refer to the outdoor unit wiring diagram.

For description of each LED (LED1–5) provided on the FTC, refer to the following table.

LED 1 (Power for microprocessor)	Indicates whether control power is supplied. Make sure that this LED is always lit.
LED 2 (Power for remote controller)	Indicates whether power is supplied to the remote controller. This LED lights only in the case of the FTC unit which is connected to the outdoor unit refrigerant address "0".
LED 3 (Communication between FTC and outdoor unit)	Indicates state of communication between the FTC and outdoor unit. Make sure that this LED is always blinking.
LED 4	—
LED 5	—

8-3. SELF-DIAGNOSIS ACTION TABLE

<Abnormalities detected when the power is turned on>

Check Code	Abnormal point and detection method	Case	Judgment and action
None	—	<p>① No voltage is supplied to terminal block (TB1) of outdoor unit. a) Power supply breaker is turned off. b) Contact failure or disconnection of power supply terminal c) Open phase (L or N phase)</p> <p>② Electric power is not charged to power supply terminal of outdoor power circuit board. a) Contact failure of power supply terminal b) Open phase on the outdoor power circuit board</p> <p>③ Electric power is not supplied to outdoor controller circuit board. a) Disconnection of connector (CNDC)</p> <p>④ Disconnection of reactor (DCL)</p> <p>⑤ Disconnection of outdoor noise filter circuit board or parts failure in outdoor noise filter circuit board</p> <p>⑥ Defective outdoor power circuit board</p> <p>⑦ Open of rush current resistor (RS) (Only for YKA2R2 type)</p> <p>⑧ Defective outdoor controller circuit board</p>	<p>① Check following items. a) Power supply breaker b) Connection of power supply terminal block (TB1) c) Connection of power supply terminal block (TB1)</p> <p>② Check following items. a) Connection of power supply terminal block (TB1) b) Connection of terminal on outdoor power circuit board</p> <p>③ Check connection of the connector (CNDC) on the outdoor controller circuit board. Check connection of the connector CNDC on the outdoor noise filter. Refer to "8-7. TEST POINT DIAGRAM".</p> <p>④ Check connection of reactor. (DCL)</p> <p>⑤ a) Check connection of outdoor noise filter circuit board. b) Replace outdoor noise filter circuit board. Refer to "8-7. TEST POINT DIAGRAM".</p> <p>⑥ Replace outdoor power circuit board.</p> <p>⑦ Replace rush current protect resistor (RS). Power circuit board might be short-circuit. Check the power circuit board. (Refer to "8-7. TEST POINT DIAGRAM".) (Only for YKA2R2 type)</p> <p>⑧ Replace controller board (When items above are checked but the units cannot be repaired).</p>
F3	<p>63L connector open Abnormal if 63L connector circuit is open for 3 minutes continuously after power supply. 63L: Low pressure switch</p>	<p>① Disconnection or contact failure of 63L connector on outdoor controller circuit board</p> <p>② Disconnection or contact failure of 63L</p> <p>③ 63L is working due to refrigerant leakage or defective parts.</p> <p>④ Defective outdoor controller circuit board</p>	<p>① Check connection of 63L connector on outdoor controller circuit board. Refer to "8-7. TEST POINT DIAGRAM".</p> <p>② Check the 63L side of connecting wire.</p> <p>③ Check refrigerant pressure. Charge additional refrigerant. Check continuity by tester. Replace the parts if the parts are defective.</p> <p>④ Replace outdoor controller circuit board.</p>
F5	<p>63H connector open Abnormal if 63H connector circuit is open for 3 minutes continuously after power supply. 63H: High pressure switch</p>	<p>① Disconnection or contact failure of 63H connector on outdoor controller circuit board</p> <p>② Disconnection or contact failure of 63H</p> <p>③ 63H is working due to defective parts.</p> <p>④ Defective outdoor controller circuit board</p>	<p>① Check connection of 63H connector on outdoor controller circuit board. Refer to "8-7. TEST POINT DIAGRAM".</p> <p>② Check the 63H side of connecting wire.</p> <p>③ Check continuity by tester. Replace the parts if the parts are defective.</p> <p>④ Replace outdoor controller circuit board.</p>
F9	<p>2 connector open Abnormal if both 63H and 63L connector circuits are open for three minutes continuously after power supply. 63H: High pressure switch 63L: Low pressure switch</p>	<p>① Disconnection or contact failure of connector (63H,63L) on outdoor controller circuit board.</p> <p>② Disconnection or contact failure of 63H, 63L</p> <p>③ 63H and 63L are working due to defective parts.</p> <p>④ Defective outdoor controller board.</p>	<p>① Check connection of connector (63H,63L) on outdoor controller circuit board. Refer to "8-7. TEST POINT DIAGRAM".</p> <p>② Check the 63H and 63L side of connecting wire.</p> <p>③ Check continuity by tester. Replace the parts if the parts are defective.</p> <p>④ Replace outdoor controller circuit board.</p>



Check Code	Abnormal point and detection method	Case	Judgment and action
EA	<p>Miswiring of Interface unit/Flow temp. controller-outdoor unit connecting wire</p> <p>1. Outdoor controller circuit board can automatically check the number of connected Interface unit/Flow temp. controller. Abnormal if the number cannot be checked automatically due to miswiring of Interface unit/Flow temp. controller-outdoor unit connecting wire, etc. after power is turned on for 4 minutes.</p> <p>2. Abnormal if outdoor controller circuit board recognizes excessive number of Interface unit/Flow temp. controller.</p>	<p>① Contact failure or miswiring of Interface unit/Flow temp. controller-outdoor unit connecting wire</p> <p>② Diameter or length of Interface unit/Flow temp. controller-outdoor unit connecting wire is out of specified capacity.</p> <p>③ Excessive number of Interface unit/Flow temp. controller is connected to 1 outdoor unit. (2 units or more)</p> <p>④ Defective transmitting receiving circuit of outdoor controller circuit board</p> <p>⑤ Defective transmitting receiving circuit of Interface/Flow temp. controller board</p> <p>⑥ Noise has entered into power supply or Interface/Flow temp. controller-outdoor unit connecting wire.</p>	<p>① Check disconnection or looseness or polarity of Interface unit/Flow temp. controller-outdoor unit connecting wire of Interface unit/Flow temp. controller and outdoor units.</p> <p>② Check diameter and length of Interface unit/Flow temp. controller-outdoor unit connecting wire. Total wiring length: 80 m (Including wiring connecting each Interface unit/Flow temp. controller unit and between Interface unit/Flow temp. controller and outdoor unit) Also check if the connection order of flat cable is S1, S2, S3.</p> <p>③ Check the number of Interface unit/Flow temp. controller that is connected to 1 outdoor unit. (If EA is detected.)</p> <p>④-⑤ Turn the power off once, and on again to check. Replace outdoor controller circuit board or Interface/Flow temp. controller board if abnormality occurs again.</p>
Eb	<p>Miswiring of Interface unit/Flow temp. controller-outdoor unit connecting wire (reverse wiring or disconnection)</p> <p>Outdoor controller circuit board can automatically set the unit number of Interface unit/Flow temp. controller.</p> <p>Abnormal if the Interface unit/Flow temp. controller number cannot be set within 4 minutes after power on because of miswiring (reverse wiring or disconnection) of Interface unit/Flow temp. controller-outdoor unit connecting wire.</p>	<p>① Contact failure or miswiring of Interface unit/Flow temp. controller-outdoor unit connecting wire</p> <p>② Diameter or length of Interface unit/Flow temp. controller-outdoor unit connecting wire is out of specified capacity.</p> <p>④ Defective transmitting receiving circuit of outdoor controller circuit board</p> <p>⑤ Defective transmitting receiving circuit of Interface/Flow temp. controller board</p> <p>⑥ Noise has entered into power supply or Interface unit/Flow temp. controller-outdoor unit connecting wire.</p>	<p>⑥ Check transmission path, and remove the cause.</p> <p>Note: The descriptions above, ①-⑥, are for EA, Eb and EC.</p>
EC	<p>Startup time over</p> <p>The unit cannot finish start up process within 4 minutes after power on.</p>	<p>① Contact failure of Interface unit /Flow temp. controller-outdoor unit connecting wire</p> <p>② Diameter or length of Interface unit/Flow temp. controller-outdoor unit connecting wire is out of specified capacity.</p> <p>⑥ Noise has entered into power supply or Interface unit/Flow temp. controller-outdoor unit connecting wire.</p>	

<Abnormalities detected while unit is operating>

Check Code	Abnormal point and detection method	Case	Judgment and action
U1	<p>High pressure (High pressure switch 63H operated) Abnormal if high pressure switch 63H operated(*) during compressor operation. *4.15 MPa</p> <p>63H: High pressure switch</p>	<p>① Short cycle of indoor unit ② Clogged filter of indoor unit ③ Decreased airflow caused by dirt of indoor fan ④ Dirt of indoor heat exchanger ⑤ Locked indoor fan motor ⑥ Malfunction of indoor fan motor ⑦ Defective operation of stop valve (Not full open) ⑧ Clogged or broken pipe ⑨ Locked outdoor fan motor ⑩ Malfunction of outdoor fan motor ⑪ Short cycle of outdoor unit ⑫ Dirt of outdoor heat exchanger ⑬ Decreased airflow caused by defective inspection of outside temperature thermistor (It detects lower temperature than actual temperature.)</p> <p>⑭ Disconnection or contact failure of connector (63H) on outdoor controller board ⑮ Disconnection or contact failure of 63H connection ⑯ Defective outdoor controller board ⑰ Defective action of linear expansion valve</p> <p>⑱ Malfunction of fan driving circuit</p>	<p>①-⑥ Check indoor unit and repair defectives.</p> <p>⑦ Check if stop valve is fully open.</p> <p>⑧ Check piping and repair defect. ⑨-⑫ Check outdoor unit and repair defect.</p> <p>⑬ Check the detected temperature of outside temperature thermistor on LED display. (SW2 on A-Control Service Tool : Refer to "8-8. FUNCTION OF SWITCHES, CONNECTORS AND JUMPERS".)</p> <p>⑭-⑯ Turn the power off and check F5 is displayed when the power is turned again. When F5 is displayed, refer to "Judgment and action" for F5.</p> <p>⑰ Check linear expansion valve. Refer to "8-6. HOW TO CHECK THE COMPONENTS".</p> <p>⑱ Replace outdoor controller board.</p>
U2	<p>High discharge temperature (1) Abnormal if discharge temperature thermistor (TH4) exceeds 125°C or 110°C continuously for 5 minutes. Abnormal if discharge temperature thermistor (TH4) exceeds 110°C or more continuously for 30 seconds after 90 seconds have passed since the defrosting operation started.</p> <p>(2) Abnormal if discharge superheat (Cooling: TH4-T_{63HS} / Heating: TH4-T_{63HS}) exceeds 70°C continuously for 10 minutes.</p> <p>High comp. surface temperature Abnormal if comp. surface temperature (TH34) exceeds 125°C. In the case of high comp. surface temperature error, compressor does not restart unless the thermistor (TH34) becomes less than 95°C.</p>	<p>① Overheated compressor operation caused by shortage of refrigerant ② Defective operation of stop valve ③ Defective thermistor ④ Defective outdoor controller board ⑤ Defective action of linear expansion valve ⑥ Clogging with foreign objects in refrigerant circuit Note: Clogging occurs in the parts which become below freezing point when water enters in refrigerant circuit.</p> <p>⑦ In the case of the unit does not restart: Detection temp. of thermistor (TH34) ≥ 95°C</p>	<p>① Check intake superheat. Check leakage of refrigerant. Charge additional refrigerant. ② Check if stop valve is fully open. ③④ Turn the power off and check if U3 is displayed when the power is turned on again. When U3 is displayed, refer to "Judgment and action" for U3. ⑤ Check linear expansion valve. Refer to "8-6. HOW TO CHECK THE COMPONENTS". ⑥ After recovering refrigerant, remove water from entire refrigerant circuit under vacuum more than 1 hour.</p>
U3	<p>Open/short circuit of discharge temperature thermistor (TH4)/Comp. surface temperature thermistor (TH34) Abnormal if open (3°C or less) or short (217°C or more) is detected during compressor operation. (Detection is inoperative for 10 minutes of compressor starting process and for 10 minutes after and during defrosting.)</p>	<p>① Disconnection or contact failure of connector (TH4/TH34) on the outdoor controller circuit board ② Defective thermistor</p> <p>③ Defective outdoor controller circuit board</p>	<p>① Check connection of connector (TH4/TH34) on the outdoor controller circuit board. Check breaking of the lead wire for thermistor (TH4/TH34). Refer to "8-7. TEST POINT DIAGRAM". ② Check resistance value of thermistor (TH4/TH34) or temperature by microprocessor. (Thermistor/TH4, TH34: Refer to "8-4. TROUBLESHOOTING".) (SW2 on A-Control Service Tool: Refer to "8-8. FUNCTION OF SWITCHES, CONNECTORS AND JUMPERS".) ③ Replace outdoor controller board.</p>



Check Code	Abnormal point and detection method	Case	Judgment and action																													
U4	Open/short of outdoor unit thermistors (TH3, TH32, TH6, TH7 and TH8) Abnormal if open or short is detected during compressor operation. Open detection of thermistors TH3, TH32 and TH6 is inoperative for 10 seconds to 10 minutes after compressor starting and 10 minutes after and during defrosting. Notes: 1. Check which unit has abnormality in its thermistor by switching the mode of SW2. (PAC-SK52ST) (Refer to "8-7. TEST POINT DIAGRAM".) 2. Heat sink thermistor (TH8) is in the power module. (YKA2/YKA2R1)	① Disconnection or contact failure of connectors Outdoor controller circuit board: (TH3, TH32, TH7/6) Outdoor power circuit board: (CN3) ② Defective thermistor ③ Defective outdoor controller circuit board	① Check connection of connector (TH3, TH32, TH7/6) on the outdoor controller circuit board. Check connection of connector (CN3) on the outdoor power circuit board. Check breaking of the lead wire for thermistor (TH3, TH32, TH6, TH7, TH8). Refer to "8-7. TEST POINT DIAGRAM". ② Check resistance value of thermistor (TH3, TH32, TH6, TH7, TH8) or check temperature by microprocessor. (Thermistor/TH3, TH6, TH7, TH32, TH8: Refer to "8-5. HOW TO CHECK THE PARTS".) (SW2 on A-Control Service Tool: Refer to "8-8. FUNCTION OF SWITCHES, CONNECTORS AND JUMPERS".) ③ Replace outdoor controller circuit board.																													
			<table border="1"> <thead> <tr> <th colspan="2">Thermistors</th> <th rowspan="2">Open detection</th> <th rowspan="2">Short detection</th> </tr> <tr> <th>Symbol</th> <th>Name</th> </tr> </thead> <tbody> <tr> <td>TH3</td> <td>Thermistor <Liquid></td> <td>-40°C or below</td> <td>90°C or above</td> </tr> <tr> <td>TH32</td> <td>Thermistor <Suction></td> <td>-40°C or below</td> <td>90°C or above</td> </tr> <tr> <td>TH6</td> <td>Thermistor <2-phase pipe></td> <td>-40°C or below</td> <td>90°C or above</td> </tr> <tr> <td>TH7</td> <td>Thermistor <Ambient></td> <td>-40°C or below</td> <td>90°C or above</td> </tr> <tr> <td>TH8 (YKA2/YKA2R1)</td> <td>Internal thermistor</td> <td>-35°C or below</td> <td>170°C or above</td> </tr> <tr> <td>TH8 (YKA2R2)</td> <td>Thermistor <Heat sink></td> <td>-34°C or below</td> <td>102°C or above</td> </tr> </tbody> </table>	Thermistors		Open detection	Short detection	Symbol	Name	TH3	Thermistor <Liquid>	-40°C or below	90°C or above	TH32	Thermistor <Suction>	-40°C or below	90°C or above	TH6	Thermistor <2-phase pipe>	-40°C or below	90°C or above	TH7	Thermistor <Ambient>	-40°C or below	90°C or above	TH8 (YKA2/YKA2R1)	Internal thermistor	-35°C or below	170°C or above	TH8 (YKA2R2)	Thermistor <Heat sink>	-34°C or below
Thermistors		Open detection	Short detection																													
Symbol	Name																															
TH3	Thermistor <Liquid>	-40°C or below	90°C or above																													
TH32	Thermistor <Suction>	-40°C or below	90°C or above																													
TH6	Thermistor <2-phase pipe>	-40°C or below	90°C or above																													
TH7	Thermistor <Ambient>	-40°C or below	90°C or above																													
TH8 (YKA2/YKA2R1)	Internal thermistor	-35°C or below	170°C or above																													
TH8 (YKA2R2)	Thermistor <Heat sink>	-34°C or below	102°C or above																													
U5	Temperature of heat sink Abnormal if heat sink thermistor (TH8) detects 95°C	① The outdoor fan motor is locked. ② Failure of outdoor fan motor ③ Airflow path is clogged. ④ Rise of ambient temperature ⑤ Defective thermistor ⑥ Defective input circuit of outdoor power circuit board ⑦ Failure of outdoor fan drive circuit	①② Check outdoor fan. ③ Check airflow path for cooling. ④ Check if there is something which causes temperature rise around outdoor unit. (Upper limit of ambient temperature is 46°C.) Turn off power, and on again to check if U5 is displayed within 30 minutes. If U4 is displayed instead of U5, follow the action to be taken for U4. ⑤ Check the thermistor (TH8) temperature by microprocessor. (SW2 on A-Control Service Tool: Refer to "8-7. TEST POINT DIAGRAM".) ⑥ Replace outdoor power circuit board. ⑦ Replace outdoor controller circuit board.																													
U6	Power module Check abnormality by driving power module in case overcurrent is detected. (UF or UP error condition)	① Outdoor stop valve is closed. ② Decrease of power supply voltage ③ Looseness, disconnection or reverse of compressor wiring connection ④ Defective compressor ⑤ Defective outdoor power circuit board	① Open stop valve. ② Check facility of power supply. ③ Correct the wiring (U·V·W phase) to compressor. Refer to "8-7. TEST POINT DIAGRAM" (Outdoor power circuit board). ④ Check compressor referring to "8-5. HOW TO CHECK THE PARTS". ⑤ Replace outdoor power circuit board.																													
U7	Too low superheat due to low discharge temperature Abnormal if discharge superheat is continuously detected less than or equal to -15°C for 3 minutes even though linear expansion valve has minimum open pulse after compressor starts operating for 10 minutes.	① Disconnection or loose connection of discharge temperature thermistor (TH4) ② Defective holder of discharge temperature thermistor ③ Disconnection or loose connection of linear expansion valve's coil ④ Disconnection or loose connection of linear expansion valve's connector ⑤ Defective linear expansion valve	①② Check the installation conditions of discharge temperature thermistor (TH4). ③ Check the coil of linear expansion valve. Refer to "8-6. HOW TO CHECK THE COMPONENTS". ④ Check the connection or contact of LEV-A and LEV-B on outdoor controller circuit board. ⑤ Check linear expansion valve. Refer to "8-6. HOW TO CHECK THE COMPONENTS".																													
U8	Outdoor fan motor Abnormal if rotational frequency of the fan motor is not detected during DC fan motor operation. Fan motor rotational frequency is abnormal if; <ul style="list-style-type: none"> • 100 rpm or below detected continuously for 15 seconds at 20°C or more outside air temperature. • 50 rpm or below or 1500 rpm or more detected continuously for 1 minute. 	① Failure in the operation of the DC fan motor ② Failure in the outdoor circuit controller board	① Check or replace the DC fan motor. ② Check the voltage of the outdoor circuit controller board during operation. ③ Replace the outdoor circuit controller board. (When the failure is still indicated even after performing the action ① above.)																													

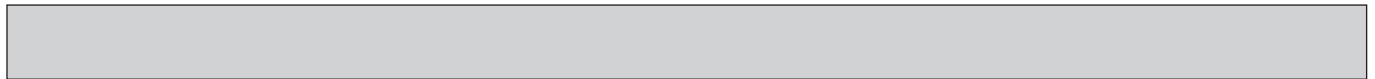

Check Code	Abnormal point and detection method	Case	Judgment and action	
U9	Detailed codes	To find out the details about U9 error, turn ON SW2-1, 2-2, 2-3, 2-4, 2-5 and 2-6 when U9 error occurs. To find out the detail history (latest) about U9 error, turn ON SW2-1, 2-2, 2-6. Refer to "8-8. FUNCTION OF SWITCHES, CONNECTORS AND JUMPERS".		
	01	Overvoltage error • Increase in DC bus voltage to 760 V	① Abnormal increase in power source voltage ② Defective outdoor power circuit board ③ Compressor has a ground fault.	① Check the field facility for the power supply. ② Replace outdoor power circuit board. ③ Check compressor for electrical insulation. Replace compressor.
	02	Undervoltage error • Instantaneous decrease in DC bus voltage to 400 V	① Decrease in power source voltage, instantaneous stop ② Defective 52C drive circuit in outdoor power circuit board ③ Disconnection or loose connection of rush current protect resistor RS ④ Defective rush current protect resistor RS ⑤ Disconnection or loose connection of main smoothing capacitor CB1/CB2 (Only for YKA2/YKA2R1 type)	① Check the field facility for the power supply. ② Replace outdoor power circuit board. ③ Check RS wiring. ④ Replace RS. ⑤ Check CB1/CB2 wiring.
	04	Input current sensor error/ L1-phase open error • Decrease in input current through outdoor unit to 0.1A only if operation frequency is more than or equal to 40 Hz or compressor current is more than or equal to 6 A.	① L1-phase open ② Disconnection or loose connection between TB1 and outdoor noise filter circuit board ③ Disconnection or loose connection of CN5 on the outdoor power circuit board/ CNCT on the outdoor noise filter board ④ Defective ACCT (AC current trans) on the outdoor power circuit board ⑤ Defective input current detection circuit in outdoor power circuit board ⑥ Defective outdoor controller circuit board	① Check the field facility for the power supply. ② Check the wiring between TB1 and outdoor noise filter circuit board. ③ Check CN5/CNCT wiring. ④ Replace outdoor noise filter circuit board. ⑤ Replace outdoor power circuit board. ⑥ Replace outdoor controller circuit board.
	08	Abnormal power synchronous signal • No input of power synchronous signal to power circuit board • Power synchronous signal of 44 Hz or less, or 65 Hz or more is detected on power circuit board.	① Distortion of power source voltage, Noise superimposition. ② Disconnection or loose connection of earth wiring ③ Disconnection or loose connection of CN2 on the outdoor power circuit board /controller circuit board ④ Defective power synchronous signal circuit in outdoor controller circuit board ⑤ Defective power synchronous signal circuit in outdoor power circuit board (Only for YKA2/YKA2R1 type)	① Check the field facility for the power supply. ② Check earth wiring. ③ Check CN2 wiring. ④ Replace outdoor controller circuit board. ⑤ Replace outdoor power circuit board.



Check Code	Abnormal point and detection method	Case	Judgment and action
Ud	Overheat protection Abnormal if outdoor pipe thermistor (TH3), condensing temperature T _{63HS} detects 70°C or more during compressor operation.	<ul style="list-style-type: none"> ① Defective outdoor fan (fan motor) or short cycle of outdoor unit during cooling operation ② Defective outdoor pipe thermistor (TH3), condensing temperature T_{63HS} ③ Defective outdoor controller board 	<ul style="list-style-type: none"> ① Check outdoor unit air passage. ②③ Turn the power off and on again to check the check code. If U4 is displayed, follow the U4 processing direction.
UE	Abnormal pressure of pressure sensor (63HS) Abnormal if pressure sensor (63HS) detects 0.1 MPa or less. Detection is inoperative for 3 minutes after compressor starting and 3 minutes after and during defrosting.	<ul style="list-style-type: none"> ① Disconnection or contact failure of connector (63HS) on the outdoor controller circuit board ② Defective pressure sensor ③ Defective outdoor controller circuit board 	<ul style="list-style-type: none"> ① Check connection of connector (63HS) on the outdoor controller circuit board. Check breaking of the lead wire for thermistor (63HS). ② Check pressure by microprocessor. (Pressure sensor/ 63HS) (SW2: Refer to "8-8. FUNCTION OF SWITCHES, CONNECTORS AND JUMPERS".) ③ Replace outdoor controller board.
UF	Compressor overcurrent interruption (When compressor is locked) Abnormal if overcurrent of DC bus or compressor is detected within 30 seconds after compressor starts operating.	<ul style="list-style-type: none"> ① Stop valve is closed. ② Decrease of power supply voltage ③ Looseness, disconnection or reverse of compressor wiring connection ④ Defective compressor ⑤ Defective outdoor power board ⑥ DIP switch setting difference of outdoor controller circuit board. 	<ul style="list-style-type: none"> ① Open stop valve. ② Check facility of power supply. ③ Correct the wiring (U·V·W phase) to compressor. Refer to "8-7. TEST POINT DIAGRAM" (Outdoor power circuit board). ④ Check compressor. Refer to "8-5. HOW TO CHECK THE PARTS". ⑤ Replace outdoor power circuit board. ⑥ Check the DIP switch setting of outdoor controller circuit board. Refer to "Model Select" in "1) Function of switches" in "8-8. FUNCTION OF SWITCHES, CONNECTORS AND JUMPERS".
UH	Current sensor error or input current error • Abnormal if current sensor detects -1.0A to 1.0A during compressor operation. (This error is ignored in case of test run mode.)	<ul style="list-style-type: none"> ① Disconnection of compressor wiring ② Defective circuit of current sensor on outdoor power circuit board ③ Decrease of power supply voltage ④ Leakage or shortage of refrigerant 	<ul style="list-style-type: none"> ① Correct the wiring (U·V·W phase) to compressor. Refer to "8-7. TEST POINT DIAGRAM" (Outdoor power circuit board). ② Replace outdoor power circuit board. ③ Check the facility of power supply. ④ Check leakage of refrigerant.
UL	Low pressure (63L operated) Abnormal if 63L is operated (under -0.03 MPa) during compressor operation. 63L: Low pressure switch	<ul style="list-style-type: none"> ① Stop valve of outdoor unit is closed during operation. ② Disconnection or loose connection of connector (63L) on outdoor controller board ③ Disconnection or loose connection of 63L ④ Defective outdoor controller board ⑤ Leakage or shortage of refrigerant ⑥ Malfunction of linear expansion valve 	<ul style="list-style-type: none"> ① Check stop valve. ②-④ Turn the power off and on again to check if F3 is displayed on restarting. If F3 is displayed, follow the F3 processing direction. ⑤ Correct to proper amount of refrigerant. ⑥ Check linear expansion valve. Refer to "8-6. HOW TO CHECK THE COMPONENTS".

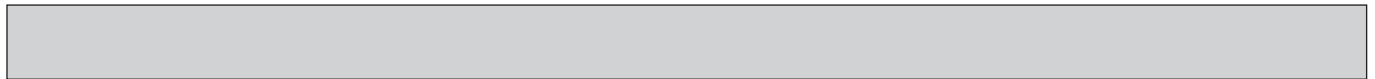

Check Code	Abnormal point and detection method	Cause	Judgment and action
UP	<p>Compressor overcurrent interruption Abnormal if overcurrent DC bus or compressor is detected after compressor starts operating for 30 seconds.</p>	<p>① Stop valve of outdoor unit is closed. ② Decrease of power supply voltage ③ Looseness, disconnection or reverse of compressor wiring connection ④ Defective fan of indoor/outdoor units ⑤ Short cycle of indoor/outdoor units ⑥ Defective input circuit of outdoor controller board</p> <p>⑦ Defective compressor</p> <p>⑧ Defective outdoor power circuit board ⑨ DIP switch setting difference of outdoor controller circuit board</p>	<p>① Open stop valve. ② Check facility of power supply. ③ Correct the wiring (U-V-W phase) to compressor. Refer to "8-7. TEST POINT DIAGRAM" (Outdoor power circuit board). ④ Check indoor/outdoor fan. ⑤ Solve short cycle. ⑥ Replace outdoor controller circuit board. Note: Before the replacement of the outdoor controller circuit board, disconnect the wiring to compressor from the outdoor power circuit board and check the output voltage among phases, U, V, W, during test run. No defect on board if voltage among phases (U-V, V-W and W-U) is same. Make sure to perform the voltage check with same performing frequency. ⑦ Check compressor. Refer to "8-5. HOW TO CHECK THE PARTS". ⑧ Replace outdoor power circuit board. ⑨ Check the dip switch setting of outdoor controller circuit board.</p>
E0 or E4	<p>Remote controller transmission error (E0)/signal receiving error (E4) ① Abnormal if main or sub remote controller cannot receive any transmission normally from Interface unit/Flow temp. controller of refrigerant address "0" for 3 minutes. (Check code: E0) ② Abnormal if sub-remote controller could not receive any signal for 2 minutes. (Check code: E0)</p> <p>① Abnormal if Interface unit/Flow temp. controller cannot receive any data normally from remote controller board or from other Interface/Flow temp. controller board for 3 minutes. (Check code: E4) ② Interface unit/Flow temp. controller cannot receive any signal from remote controller for 2 minutes. (Check code: E4)</p>	<p>① Contact failure at transmission wire of remote controller ② Miswiring of remote controller ③ Defective transmitting receiving circuit of remote controller</p> <p>④ Noise has entered into the transmission wire of remote controller.</p> <p>Refer to the indoor unit's Installation Manual for remote controller connection.</p>	<p>① Check disconnection or looseness of Interface unit/Flow temp. controller or transmission wire of remote controller. ② Check wiring of remote controller. • Total wiring length: max. 500 m (Do not use cable x 3 or more.)</p> <p>If the cause of trouble is not in ①-② above, ④ Diagnose remote controllers. a) When "RC OK" is displayed, remote controllers have no problem. Turn the power off, and on again to check. If abnormality occurs again, replace PCB of Interface unit/Flow temp. controller. b) When "RC NG" is displayed, replace remote controller. c) When "RC E3" or "ERC 00-66" is displayed, noise may be causing abnormality.</p>
E1 or E2	<p>Remote controller control board ① Abnormal if data cannot be read normally from the nonvolatile memory of the remote controller control board. (Check code: E1) ② Abnormal if the clock function of remote controller cannot be operated normally. (Check code: E2)</p>	<p>① Defective remote controller</p>	<p>① Replace remote controller.</p>
E3 or E5	<p>Remote controller transmission error (E3)/signal receiving error (E5) ① Abnormal if remote controller could not find blank of transmission path for 6 seconds and could not transmit. (Check code: E3) ② When remote controller receives the transmitted data same time and compares these data. Abnormal if the data is judged to be different for 30 continuous times. (Check code: E3)</p> <p>① Abnormal if Interface unit/Flow temp. controller could not find blank of transmission path. (Check code: E5) ② When Interface unit/Flow temp. controller receives the transmitted data same time and compares these data. Abnormal if the data is judged to be different for 30 continuous times. (Check code: E5)</p>	<p>① Defective transmitting receiving circuit of remote controller ② Defective transmitting receiving circuit of Interface unit/Flow temp. controller ③ Noise has entered into transmission wire of remote controller.</p> <p>Refer to the indoor unit's Installation Manual for remote controller connection.</p>	<p>①-③ Diagnose remote controller. a) When "RC OK" is displayed, remote controllers have no problem. Turn the power off, and on again to check. When becoming abnormal again, replace indoor controller board. b) When "RC NG" is displayed, replace remote controller. c) When "RC E3" or "ERC 00-66" is displayed, noise may be causing abnormality.</p>





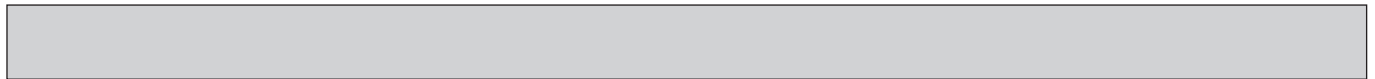

Check Code	Abnormal point and detection method	Case	Judgment and action
E6	Interface unit/Flow temp. controller or outdoor unit communication error (Signal receiving error) ① Abnormal if Interface unit/Flow temp. controller cannot receive any signal normally for 6 minutes after turning the power on. ② Abnormal if Interface unit/Flow temp. controller cannot receive any signal normally for 3 minutes.	① Contact failure, short circuit or, miswiring (reverse wiring) of Interface unit/Flow temp. controller or outdoor unit connecting wire ② Defective transmitting receiving circuit of outdoor controller circuit board ③ Defective transmitting receiving circuit of Interface unit/Flow temp. controller ④ Noise has entered into Interface unit/Flow temp. controller or outdoor unit connecting wire.	Note: Check LED display on the outdoor controller circuit board. (Connect A-control service tool, PAC-SK52ST.) ① Check disconnection or looseness of Interface unit/Flow temp. controller or outdoor unit connecting wire of Interface unit/Flow temp. controller or outdoor unit. ②-④ Turn the power off, and on again to check. If abnormality occurs again, replace Interface unit/Flow temp. controller or outdoor controller circuit board.
E8	Interface unit/Flow temp. controller or outdoor unit communication error (Signal receiving error) (Outdoor unit) (1) Abnormal if outdoor controller circuit board could not receive anything normally for 3 minutes.	① Contact failure of Interface unit/Flow temp. controller or outdoor unit connecting wire ② Defective communication circuit of outdoor controller circuit board ③ Defective communication circuit of Interface unit/Flow temp. controller ④ Noise has entered into Interface unit/Flow temp. controller or outdoor unit connecting wire.	① Check disconnection or looseness of Interface unit/Flow temp. controller or outdoor unit connecting wire of Interface unit/Flow temp. controller or outdoor unit. ②-④ Turn the power off, and on again to check. Replace PCB of Interface unit/Flow temp. controller or outdoor controller circuit board if abnormality is displayed again.
E9	Interface unit/Flow temp. controller or outdoor unit communication error (Transmitting error) (Outdoor unit) (1) Abnormal if "0" receiving is detected 30 times continuously though outdoor controller circuit board has transmitted "1". (2) Abnormal if outdoor controller circuit board could not find blank of transmission path for 3 minutes.	① Interface unit/Flow temp. controller or outdoor unit connecting wire has contact failure. ② Defective communication circuit of outdoor controller circuit board ③ Noise has entered power supply. ④ Noise has entered Interface unit/Flow temp. controller or outdoor unit connecting wire.	① Check disconnection or looseness of Interface unit/Flow temp. controller or outdoor unit connecting wire. ②-④ Turn the power off, and on again to check. Replace outdoor controller circuit board if abnormality is displayed again.
EF	Non defined check code This code is displayed when non defined check code is received.	① Noise has entered transmission wire of remote controller. ② Noise has entered Interface unit/Flow temp. controller-outdoor unit connecting wire.	①② Turn the power off, and on again to check. Replace Interface/FTC or outdoor controller circuit board if abnormality is displayed again.
Ed	Serial communication error Abnormal if serial communication between outdoor controller circuit board and outdoor power circuit board is defective.	① Wire disconnection or contact failure of connector CN2 between the outdoor controller circuit board and the outdoor power circuit board ② Wire disconnection or contact failure of connector CN4 between the outdoor controller circuit board and the outdoor power circuit board ③ Defective communication circuit of outdoor power circuit board ④ Defective communication circuit of outdoor controller circuit board for outdoor power circuit board	①② Check connection of each connector CN2 and CN4 between the outdoor controller circuit board and the outdoor power circuit board. ③ Replace outdoor power circuit board. ④ Replace outdoor controller circuit board.



Check Code	Abnormal point and detection method	Cause	Judgment and action										
P1	<p>Actual flow water temperature thermistor (TH1)</p> <p>① The unit is in 3-minute resume prevention mode if short/open of thermistor is detected. Abnormal if the unit does not reset normally after 3 minutes. (The unit returns to normal operation, if it has been reset normally.)</p> <p>② Constantly detected during cooling, heating ECO, anti freeze, hot water and heating operation. Short: -90°C or more Open: -40°C or less</p>	<p>① Defective thermistor characteristics</p> <p>② Breaking of wire or contact failure of thermistor wiring</p> <p>③ Defective PCB of Interface unit/ Flow temp. controller</p> <p>Refer to the indoor unit's Installation Manual for TH1 connection.</p>	<p>①-② Check resistance value of thermistor.</p> <table border="1"> <tr><td>0°C</td><td>15.0 kΩ</td></tr> <tr><td>10°C</td><td>9.6 kΩ</td></tr> <tr><td>20°C</td><td>6.3 kΩ</td></tr> <tr><td>30°C</td><td>4.3 kΩ</td></tr> <tr><td>40°C</td><td>3.0 kΩ</td></tr> </table> <p>If you put force on (draw or bend) the lead wire with measuring resistance value of thermistor, breaking of wire or contact failure can be detected.</p> <p>③ Check actual flow water temperature display on remote controller. Replace PCB of Interface unit/Flow temp. controller if there is abnormal difference with actual flow water temperature.</p> <p>Turn the power off, and on again to operate after check.</p>	0°C	15.0 kΩ	10°C	9.6 kΩ	20°C	6.3 kΩ	30°C	4.3 kΩ	40°C	3.0 kΩ
0°C	15.0 kΩ												
10°C	9.6 kΩ												
20°C	6.3 kΩ												
30°C	4.3 kΩ												
40°C	3.0 kΩ												
P2	<p>Pipe temperature thermistor/Liquid (TH2)</p> <p>① The unit is in 3-minute resume prevention mode if short/open of thermistor is detected. Abnormal if the unit does not reset normally after 3 minutes. (The unit returns to normal operation, if it has been reset normally.)</p> <p>② Constantly detected during cooling, heating ECO, anti freeze, hot water and heating (except defrosting) operation Short: 90°C or more Open: -40°C or less</p>	<p>① Defective thermistor characteristics</p> <p>② Breaking of wire or contact failure of thermistor wiring</p> <p>③ Defective refrigerant circuit is causing thermistor temperature of 90°C or more or -40°C or less.</p> <p>④ Defective PCB of Interface unit/ Flow temp. controller</p> <p>Refer to the indoor unit's Installation Manual for TH2 connection.</p>	<p>①-② Check resistance value of thermistor. For characteristics, refer to (P1) above.</p> <p>③ Check pipe <liquid> temperature with remote controller in test run mode. If pipe <liquid> temperature is extremely low (in cooling mode) or high (in heating mode), refrigerant circuit may have defective.</p> <p>④ Check pipe <liquid> temperature with remote controller in test run mode. If there is extremely difference with actual pipe <liquid> temperature, replace PCB of Interface unit/ Flow temp. controller.</p> <p>Turn the power off, and on again to operate after check.</p>										
P6	<p>Freezing/overheating protection is working</p> <p>① Freezing protection (Cooling mode) The unit is in 6-minute resume prevention mode if pipe temperature stays under -15°C for 3 minutes, 3 minutes after the compressor started. Abnormal if it stays under -15°C for 3 minutes again within 16 minutes after 6-minute resume prevention mode.</p> <p>② Overheating protection (Heating, heating ECO, Anti freeze, Hot water mode) The units is in 6-minute resume prevention mode if pipe temperature is detected as over 70°C after the compressor started. Abnormal if the temperature of over 70°C is detected again within 30 minutes after 6-minute resume prevention mode.</p>	<p>(Cooling mode)</p> <p>① Short cycle of air path</p> <p>② Low-load (low temperature) operation out of the tolerance range</p> <p>③ Defective outdoor fan control</p> <p>④ Overcharge of refrigerant</p> <p>⑤ Defective refrigerant circuit (clogs)</p> <p>(Heating mode)</p> <p>① Short cycle of air path</p> <p>② Overload (high temperature) operation out of the tolerance range</p> <p>③ Defective outdoor fan control</p> <p>④ Overcharge of refrigerant</p> <p>⑤ Defective refrigerant circuit (clogs)</p> <p>⑥ Bypass circuit of outdoor unit is defective.</p>	<p>(Cooling mode)</p> <p>① Remove blockage.</p> <p>③ Check outdoor fan motor.</p> <p>④⑤ Check operating condition of refrigerant circuit.</p> <p>(Heating mode)</p> <p>① Remove blockage.</p> <p>③ Check outdoor fan motor.</p> <p>④-⑥ Check operating condition of refrigerant circuit.</p>										
P9	<p>Actual tank temperature thermistor (TH5/ THW5)</p> <p>① The unit is 3-minute resume prevention mode if short/open of thermistor is detected. Abnormal if the unit does not reset normally after 3 minutes. (The unit returns to normal operation, if it has been reset normally)</p> <p>② Constantly detected during cooling, heating, heating ECO, anti freeze and hot water operation.</p>	<p>① Defective thermistor characteristics</p> <p>② Breaking of wire or contact failure of thermistor wiring</p> <p>③ Defective PCB of interface unit/ Flow temp. controller</p> <p>Refer to the indoor unit's Installation Manual for TH5/THW5 connection.</p>	<p>①-② Check resistance value of thermistor.</p> <table border="1"> <tr><td>0°C</td><td>15.0 kΩ</td></tr> <tr><td>10°C</td><td>9.6 kΩ</td></tr> <tr><td>20°C</td><td>6.3 kΩ</td></tr> <tr><td>30°C</td><td>4.3 kΩ</td></tr> <tr><td>40°C</td><td>3.0 kΩ</td></tr> </table> <p>If you put force on (draw or bend) the lead wire with measuring resistance value of thermistor, breaking of wire or contact failure can be detected.</p> <p>③ Check actual tank temperature display on remote controller. Replace PCB of Interface unit/Flow temp. controller if there is abnormal difference with actual tank temperature.</p> <p>Turn the power off, and on again to operate after check.</p>	0°C	15.0 kΩ	10°C	9.6 kΩ	20°C	6.3 kΩ	30°C	4.3 kΩ	40°C	3.0 kΩ
0°C	15.0 kΩ												
10°C	9.6 kΩ												
20°C	6.3 kΩ												
30°C	4.3 kΩ												
40°C	3.0 kΩ												

8-4. TROUBLESHOOTING

A flowing water sound or occasional hissing sound is heard.	<ul style="list-style-type: none"> These sounds can be heard when refrigerant and/or water is (are) flowing in the indoor unit or refrigerant pipe, or when the refrigerant and/or water is (are) chugging.
Water does not heat or cool well.	<ul style="list-style-type: none"> Clean the filter of water piping. (Flow is reduced when the filter is dirty or clogged.) Check the temperature adjustment and adjust the set temperature. Make sure that there is plenty of space around the outdoor unit.
Water or vapour is emitted from the outdoor unit.	<ul style="list-style-type: none"> During cooling mode, water may form and drip from the cool pipes and joints. During heating mode, water may form and drip from the heat exchanger of outdoor unit. During defrosting mode, water on the heat exchanger of outdoor unit evaporates and water vapour may be emitted.
The operation indicator does not appear in the remote controller display.	<ul style="list-style-type: none"> Turn on the power switch. "●" will appear in the remote controller display.
"  appears in the remote controller display.	<ul style="list-style-type: none"> During external signal control, "
When restarting the outdoor unit soon after stopping it, it does not operate even though the ON/OFF button is pressed.	<ul style="list-style-type: none"> Wait approximately 3 minutes. (Operation has stopped to protect the outdoor unit.)
FTC operates without the ON/OFF button being pressed.	<ul style="list-style-type: none"> Is the on timer set? Press the ON/OFF button to stop operation. Is the FTC connected to a external signal? Consult the concerned people who control the FTC. Does "
FTC stops without the ON/OFF button being pressed.	<ul style="list-style-type: none"> Is the off timer set? Press the ON/OFF button to restart operation. Is the air conditioner connected to a central remote controller? Consult the concerned people who control the FTC. Does "
Remote controller timer operation cannot be set.	<ul style="list-style-type: none"> Are timer settings invalid? If the timer can be set, (WEEKLY), (SIMPLE), or (AUTO OFF) appears in the remote controller display.
"PLEASE WAIT" appears in the remote controller display.	<ul style="list-style-type: none"> The initial settings are being performed. Wait approximately 3 minutes. If the remote controller is not only for FTC, change it.
A check code appears in the remote controller display.	<ul style="list-style-type: none"> The protection devices have operated to protect the FTC and outdoor unit. Do not attempt to repair this equipment by yourself. Turn off the power switch immediately and consult your dealer. Be sure to provide the dealer with the model name and information that appeared in the remote controller display.

• If the unit cannot be operated properly after test run, refer to the following table to find the cause.

Symptom		Cause
Wired remote controller	LED 1, 2 (PCB in outdoor unit)	
PLEASE WAIT	For about 2 minutes after power-on	After LED 1, 2 are lit, LED 2 is turned off, then only LED 1 is lit. (Correct operation)
PLEASE WAIT → Check code	Subsequent to about 2 minutes after power-on	Only LED 1 is lit. → LED 1, 2 blink.
Display messages do not appear even when operation switch is turned ON (operation lamp does not light up).		Only LED 1 is lit. → LED 1 blinks twice, LED 2 blinks once.

Note: Operation is not possible for about 30 seconds after cancellation of function selection. (Correct operation)

For description of each LED (LED1, 2, 3) provided on the FTC, refer to the following table.

LED1 (power for microprocessor)	Indicates whether control power is supplied. Make sure that this LED is always lit.
LED2 (power for remote controller)	Indicates whether power is supplied to the remote controller. This LED lights only in the case of the FTC which is connected to the outdoor unit refrigerant addresses "0".
LED3 (communication between FTC and outdoor units)	Indicates state of communication between the FTC and outdoor units. Make sure that this LED is always blinking.

8-5. HOW TO CHECK THE PARTS

PUHZ-SHW230YKA2

PUHZ-SHW230YKA2R1

PUHZ-SHW230YKA2R2

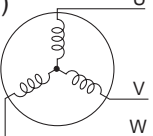
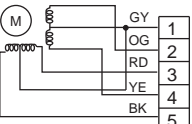
Parts name	Checkpoints														
Thermistor (TH3) <Liquid> Thermistor (TH4) <Discharge> Thermistor (TH6) <2-Phase Pipe> Thermistor (TH7) <Ambient> Thermistor (TH32) <Suction> Thermistor (TH34) <Comp. Surface>	Disconnect the connector then measure the resistance with a tester. (At the ambient temperature 10 to 30°C) <table border="1" style="margin-top: 10px;"> <thead> <tr> <th></th> <th>Normal</th> <th>Abnormal</th> </tr> </thead> <tbody> <tr> <td>TH4 TH34</td> <td>160 to 410kΩ</td> <td rowspan="3">Open or short</td> </tr> <tr> <td>TH3 TH6 TH7 TH32</td> <td>4.3 to 9.6kΩ</td> </tr> <tr> <td>TH8*</td> <td>39 to 105kΩ</td> </tr> </tbody> </table> <p style="text-align: right; margin-top: 10px;">*YKA2R2 type only</p>		Normal	Abnormal	TH4 TH34	160 to 410kΩ	Open or short	TH3 TH6 TH7 TH32	4.3 to 9.6kΩ	TH8*	39 to 105kΩ				
	Normal	Abnormal													
TH4 TH34	160 to 410kΩ	Open or short													
TH3 TH6 TH7 TH32	4.3 to 9.6kΩ														
TH8*	39 to 105kΩ														
Fan motor(MF1,MF2)	Refer to the next page.														
Solenoid valve (4-way valve) (21S4)	Measure the resistance between the terminals with a tester. (At the ambient temperature 20°C) <table border="1" style="margin-top: 10px;"> <thead> <tr> <th>Normal</th> <th>Abnormal</th> </tr> </thead> <tbody> <tr> <td>1435 ±150 Ω</td> <td>Open or short</td> </tr> </tbody> </table>	Normal	Abnormal	1435 ±150 Ω	Open or short										
Normal	Abnormal														
1435 ±150 Ω	Open or short														
Motor for compressor (MC) 	Measure the resistance between the terminals with a tester. (Winding temperature 20°C) <table border="1" style="margin-top: 10px;"> <thead> <tr> <th>Normal (U-V, U-W, W-V)</th> <th>Abnormal</th> </tr> </thead> <tbody> <tr> <td>0.37 Ω</td> <td>Open or short</td> </tr> </tbody> </table>	Normal (U-V, U-W, W-V)	Abnormal	0.37 Ω	Open or short										
Normal (U-V, U-W, W-V)	Abnormal														
0.37 Ω	Open or short														
Linear expansion valve (LEV-A/LEV-B/LEV-C) 	Disconnect the connector then measure the resistance with a tester. (Winding temperature 20°C) <table border="1" style="margin-top: 10px;"> <thead> <tr> <th colspan="4">Normal</th> <th>Abnormal</th> </tr> </thead> <tbody> <tr> <td>Gray - Black</td> <td>Gray - Red</td> <td>Gray - Yellow</td> <td>Gray - Orange</td> <td rowspan="2">Open or short</td> </tr> <tr> <td colspan="4" style="text-align: center;">46 ± 3 Ω</td> </tr> </tbody> </table>	Normal				Abnormal	Gray - Black	Gray - Red	Gray - Yellow	Gray - Orange	Open or short	46 ± 3 Ω			
Normal				Abnormal											
Gray - Black	Gray - Red	Gray - Yellow	Gray - Orange	Open or short											
46 ± 3 Ω															

Check method of DC fan motor (fan motor/outdoor controller circuit board)

Notes

- High voltage is applied to the connector (CNF1, 2) for the fan motor. Pay attention to the service.
- Do not pull out the connector (CNF1, 2) for the motor with the power supply on.
(It causes trouble of the outdoor controller circuit board and fan motor.)

Self check

Symptom : The outdoor fan cannot rotate.

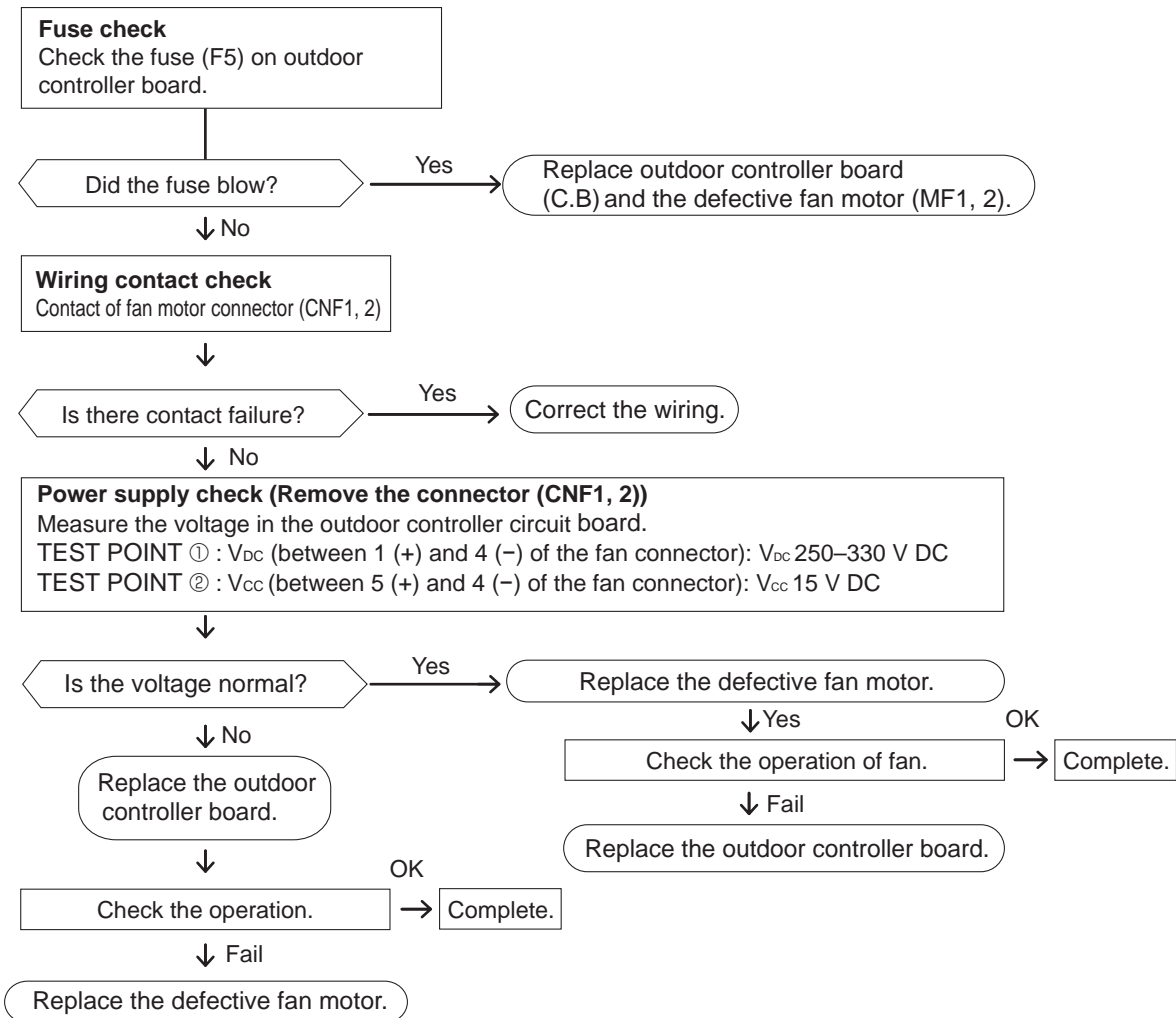

8-6. HOW TO CHECK THE COMPONENTS

<Thermistor feature chart>

Low temperature thermistors

- Thermistor <Liquid> (TH3)
- Thermistor <2-Phase Pipe> (TH6)
- Thermistor <Ambient> (TH7)
- Thermistor <Suction> (TH32)

Thermistor R0 = 15 kΩ ± 3%

B constant = 3480 ± 2%

$$R_t = 15 \exp\left\{3480 \left(\frac{1}{273+t} - \frac{1}{273} \right)\right\}$$

0°C	15 kΩ	30°C	4.3 kΩ
10°C	9.6 kΩ	40°C	3.0 kΩ
20°C	6.3 kΩ		
25°C	5.2 kΩ		

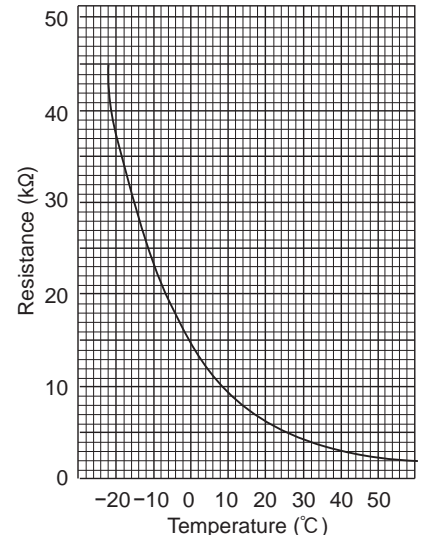

Medium temperature thermistor

- Thermistor <Heat sink> (TH8)
(YKA2R2 type only)

Thermistor R50 = 17 kΩ ± 2%

B constant = 4150 ± 3%

$$R_t = 17 \exp\left\{4150 \left(\frac{1}{273+t} - \frac{1}{323} \right)\right\}$$

0 °C	180 kΩ
25 °C	50 kΩ
50 °C	17 kΩ
70 °C	8 kΩ
90 °C	4 kΩ

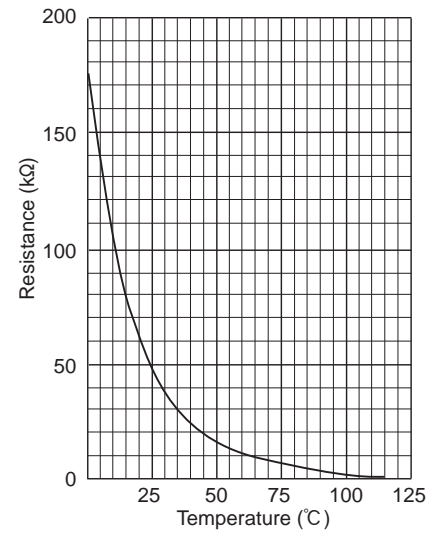

High temperature thermistors

- Thermistor <Discharge> (TH4)
- Thermistor <Comp. Surface> (TH34)

Thermistor R120 = 7.465 kΩ ± 2%

B constant = 4057 ± 2%

$$R_t = 7.465 \exp\left\{4057 \left(\frac{1}{273+t} - \frac{1}{393} \right)\right\}$$

20°C	250 kΩ	70°C	34 kΩ
30°C	160 kΩ	80°C	24 kΩ
40°C	104 kΩ	90°C	17.5 kΩ
50°C	70 kΩ	100°C	13.0 kΩ
60°C	48 kΩ	110°C	9.8 kΩ

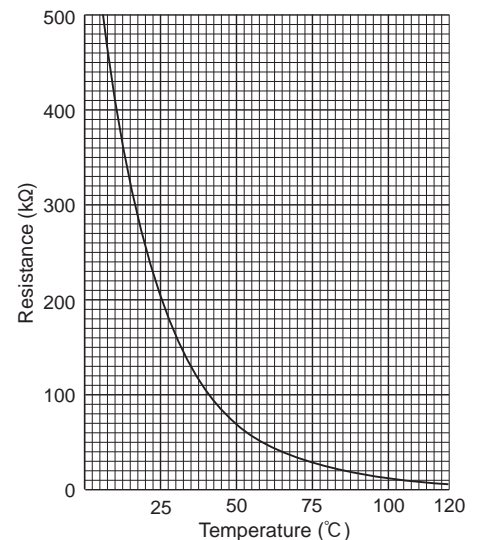

<HIGH PRESSURE SENSOR>

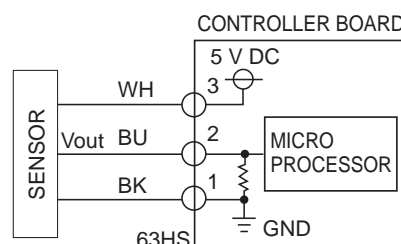
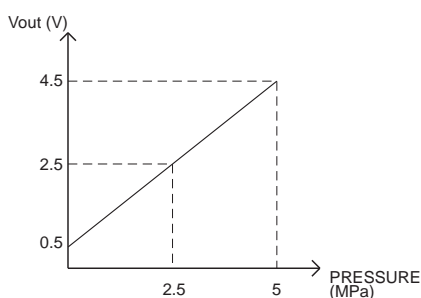

- ③-① : 5 V (DC)
- ②-① : Output Vout (DC)

Linear expansion valve

(1) Operation summary of the linear expansion valve

- Linear expansion valve opens/closes through stepping motor after receiving the pulse signal from the outdoor controller board.
- Valve position can be changed in proportion to the number of pulse signal.

<Connection between the outdoor controller board and the linear expansion valve>

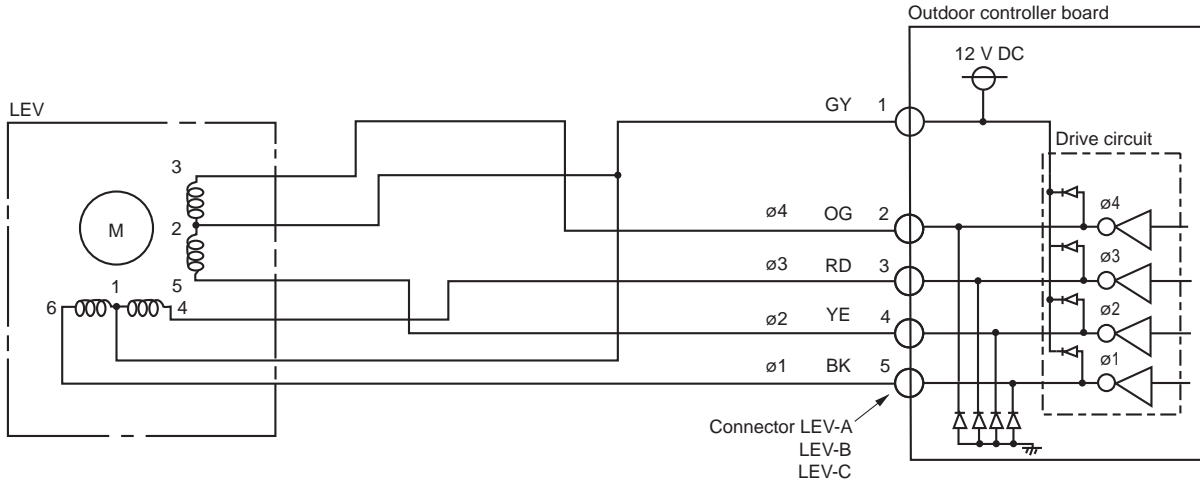

<Output pulse signal and the valve operation>

Output (Phase)	Output							
	1	2	3	4	5	6	7	8
ø1	ON	ON	OFF	OFF	OFF	OFF	OFF	ON
ø2	OFF	ON	ON	ON	OFF	OFF	OFF	OFF
ø3	OFF	OFF	OFF	ON	ON	ON	OFF	OFF
ø4	OFF	OFF	OFF	OFF	OFF	ON	ON	ON

Opening a valve : 8 → 7 → 6 → 5 → 4 → 3 → 2 → 1 → 8

Closing a valve : 1 → 2 → 3 → 4 → 5 → 6 → 7 → 8 → 1

The output pulse shifts in above order.

- When linear expansion valve operation stops, all output phases become OFF.

(2) Linear expansion valve operation

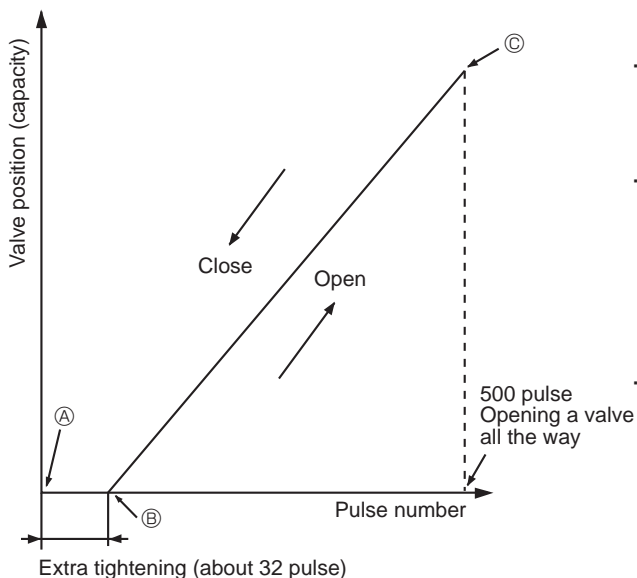

- When the power is turned on, 700 pulse closing valve signal will be sent till it goes to ① point in order to define the valve position. (The pulse signal is being sent for about 20 seconds.)
- When the valve moves smoothly, there is no sound or vibration occurring from the linear expansion valve : however, when the pulse number moves from ② to ① or when the valve is locked, more sound can be heard. No sound is heard when the pulse number moves from ② to ① in case coil is burnt out or motor is locked by open-phase.
- Sound can be detected by placing the ear against the screw driver handle while putting the screw driver to the linear expansion valve.

(3) How to attach and detach the coil of linear expansion valve

<Composition>

Linear expansion valve is separable into the main body and the coil as shown in the diagram below.

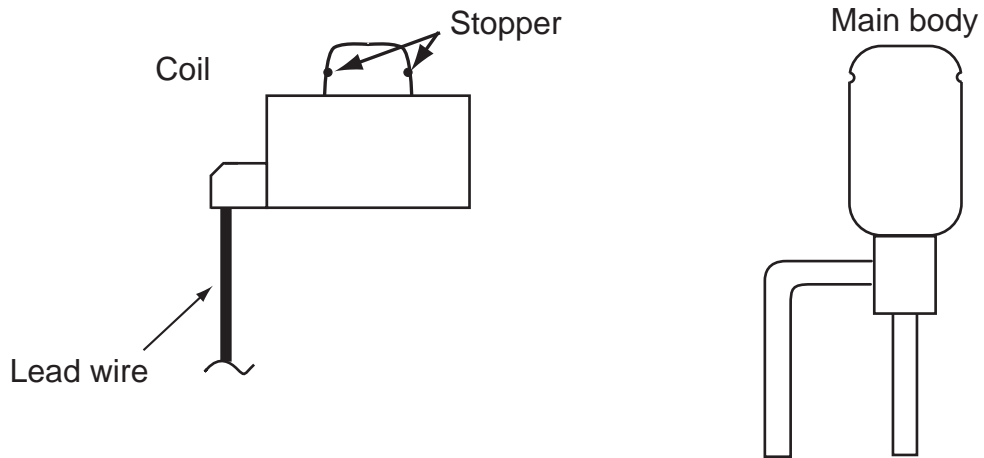

<How to detach the coil>

Hold the lower part of the main body (shown as A) firmly so that the main body does not move and detach the coil by pulling it upward.

Be sure to detach the coil holding main body firmly. Otherwise pipes can bend due to stress.

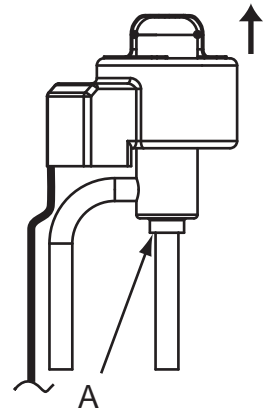

<How to attach the coil>

Hold the lower part of the main body (shown as A) firmly so that the main body does not move and attach the coil by inserting it downward into the main body. Then securely attach the coil stopper to main body. (At this time, be careful that stress is not added to lead wire and main body is not wound by lead wire.) If the stopper is not firmly attached to main body, coil may be detached from the main body and that can cause defective operation of linear expansion valve.

To prevent piping stress, be sure to attach the coil holding the main body of linear expansion valve firmly. Otherwise pipe may break.

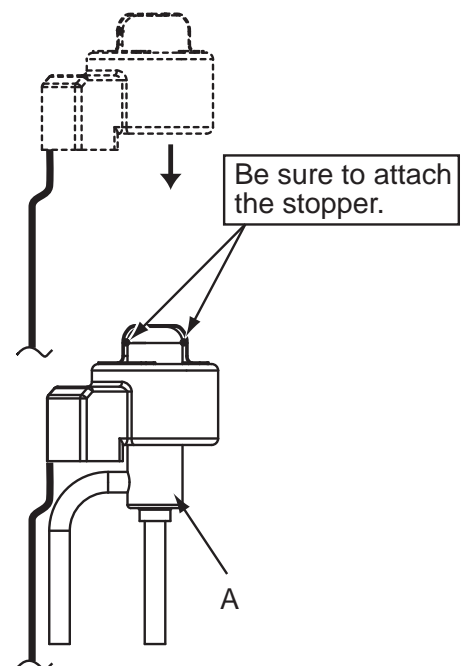

Outdoor controller circuit board PUHZ-SHW230YKA2R2

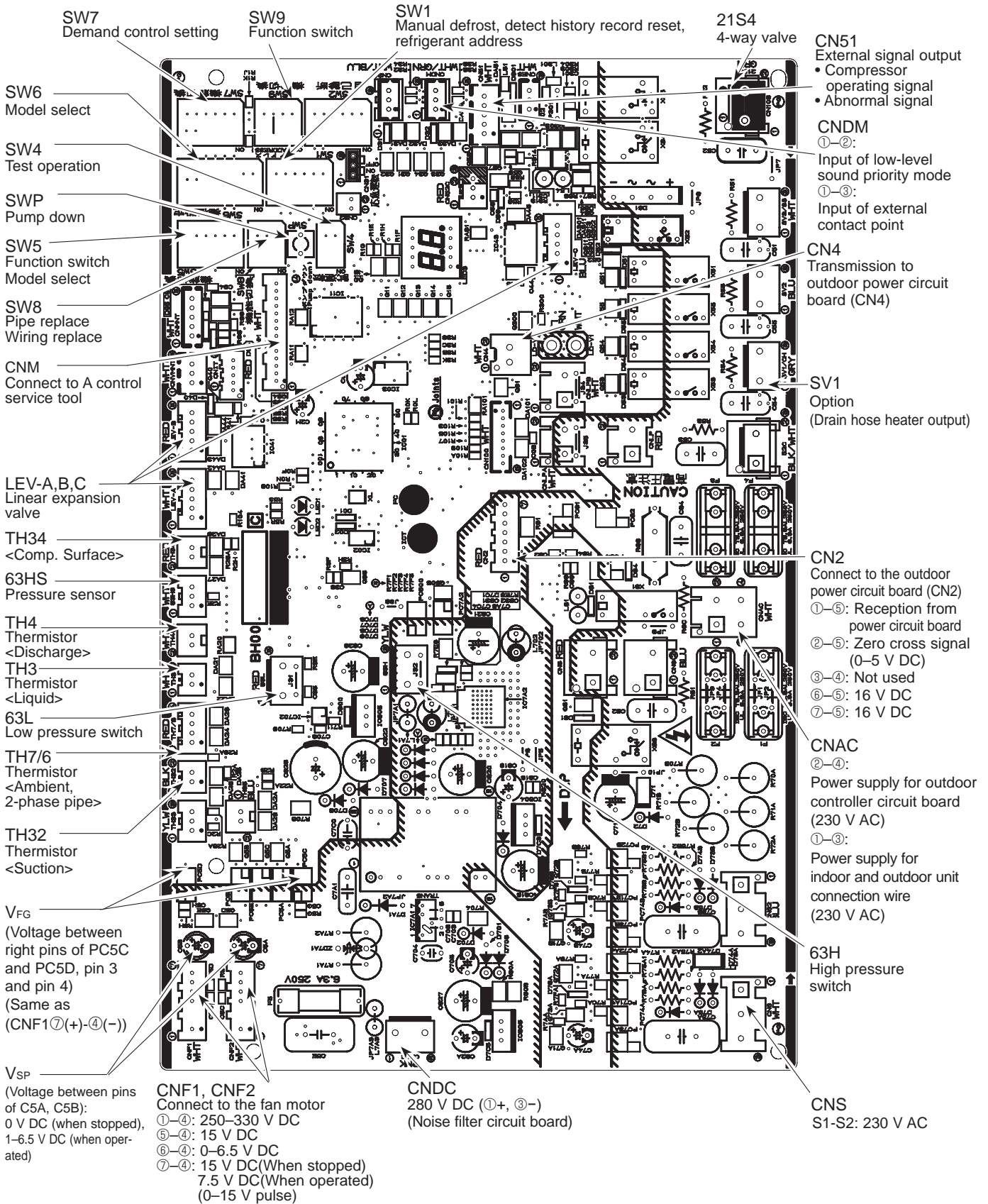

Outdoor noise filter circuit board
PUHZ-SHW230YKA2 PUAZ-SHW230YKA2R1

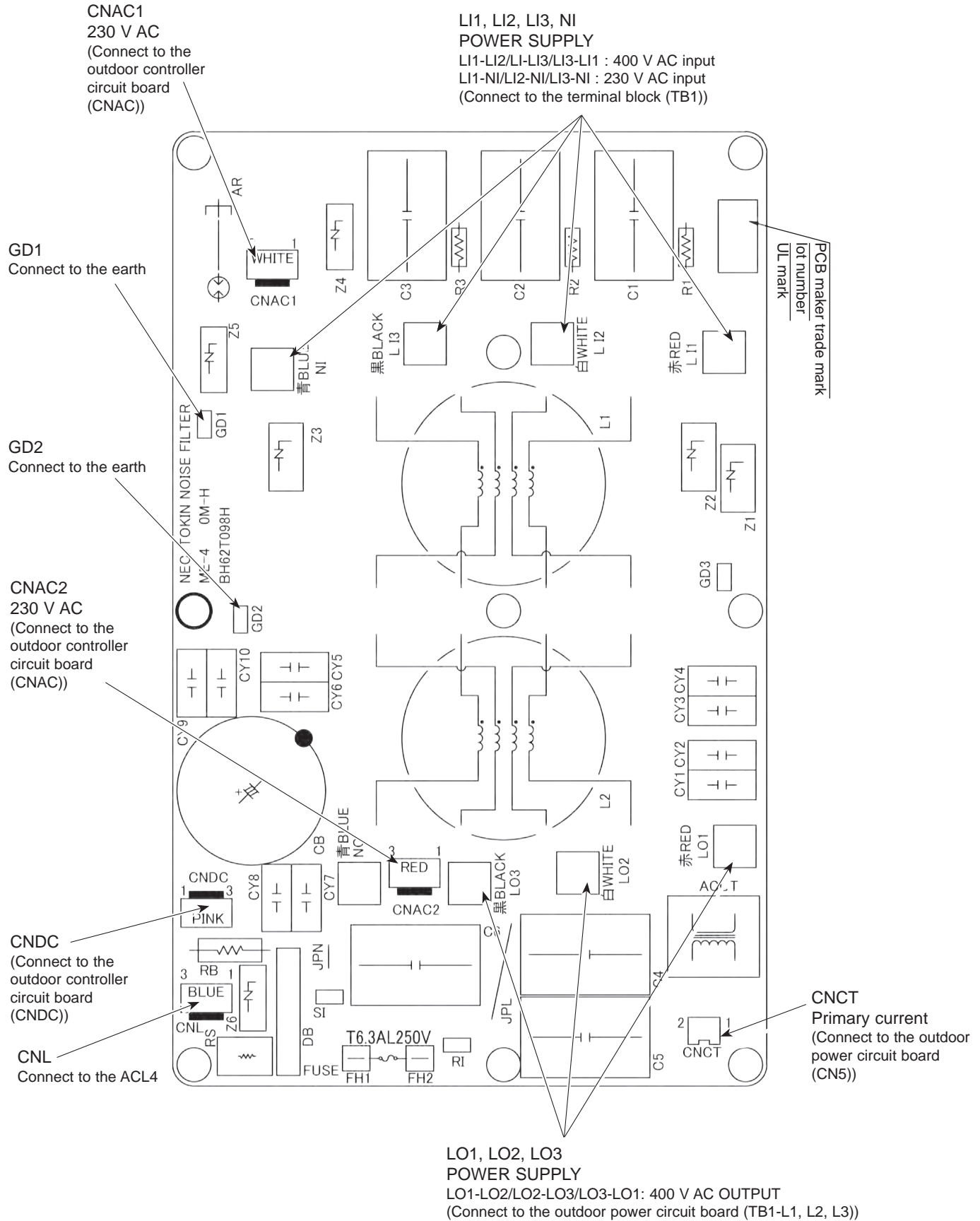

Outdoor power circuit board
PUHZ-SHW230YKA2
PUHZ-SHW230YKA2R1

Brief Check of POWER MODULE

If they are short-circuited, it means that they are broken.
 Measure the resistance in the following points (connectors, etc.).

1. Check of POWER MODULE

① Check of DIODE circuit

L1-**P1**, **L2**-**P1**, **L3**-**P1**, **L1** -**N1** , **L2** -**N1** , **L3** -**N1**

② Check of IGBT circuit

P2-**U** , **P2**-**V** , **P2**-**W** , **N2**-**U** , **N2**-**V** , **N2**-**W**

Note: The marks, **L1** , **L2** , **L3** , **N1** , **N2** , **P1** , **P2** , **U** , **V** and **W** shown in the diagram are not actually printed on the board.

CN5
 Detection of primary current
 (Connect to the outdoor noise filter circuit board (CNCT))

CN4
 Connect to the outdoor controller circuit board (CN4)

CN7
 Connect to the outdoor converter circuit board (CN7)

CN2
 Connect to the outdoor controller circuit board (CN2)
 ①-⑤: Power circuit board → Transmitting signal to the controller board (0-5 V DC)
 ②-⑤: Zero cross signal (0-5 V DC)
 ③-④: Not used [⑤ : ⊖ ①, ②, ⑥, ⑦ : ⊕]
 ⑥-⑤: 16 V DC
 ⑦-⑤: 16 V DC

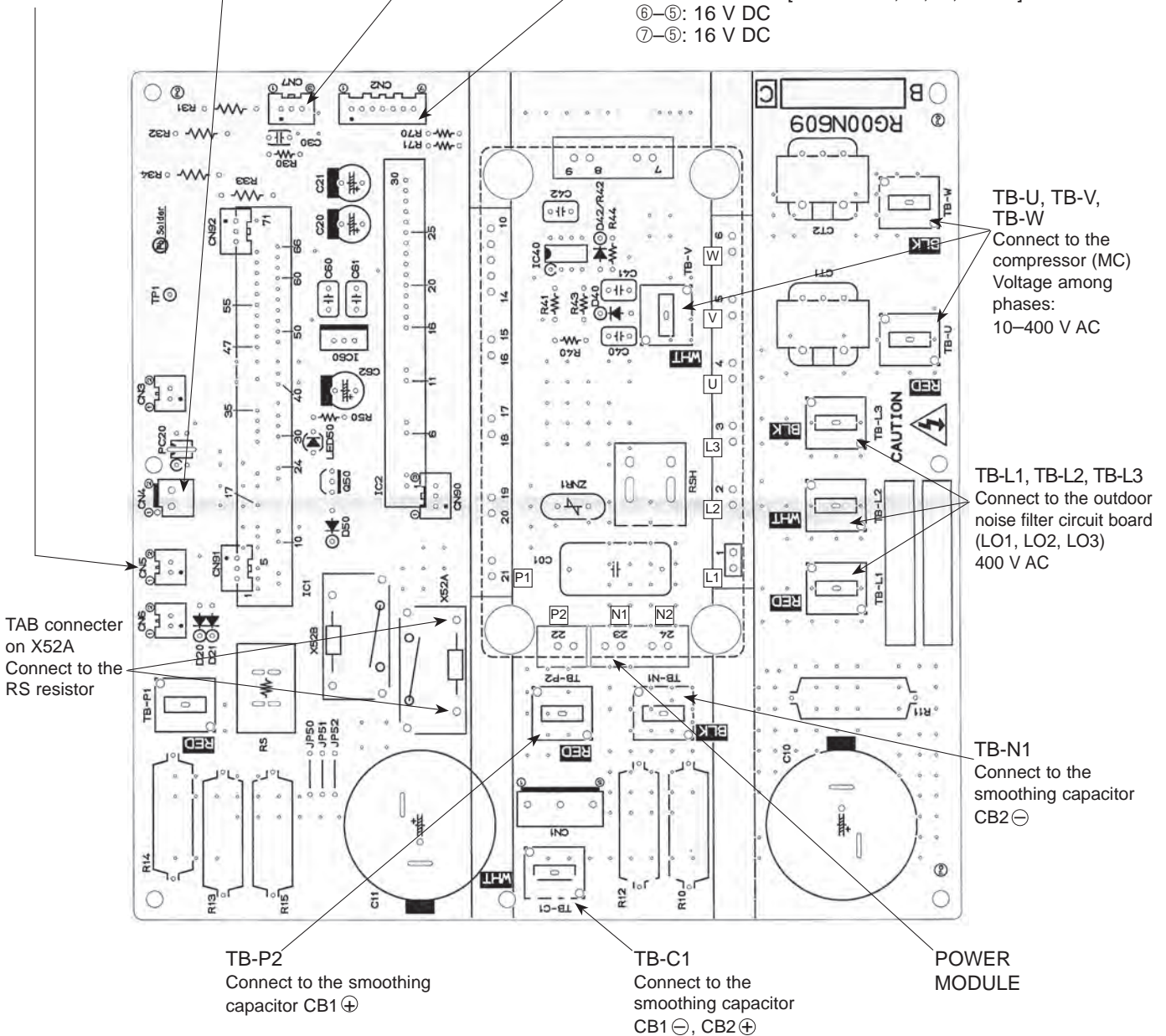

TB-U, TB-V, TB-W
 Connect to the compressor (MC)
 Voltage among phases:
 10-400 V AC

TB-L1, TB-L2, TB-L3
 Connect to the outdoor noise filter circuit board (LO1, LO2, LO3)
 400 V AC

TB-N1
 Connect to the smoothing capacitor CB2 ⊖

TB-P2
 Connect to the smoothing capacitor CB1 ⊕

TB-C1
 Connect to the smoothing capacitor CB1 ⊖, CB2 ⊕

POWER MODULE

Outdoor power circuit board PUHZ-SHW230YKA2R2

Brief Check of POWER MODULE

Usually, they are in a state of being short-circuited if they are broken. Measure the resistance in the following points (connectors, etc.). If they are short-circuited, it means that they are broken.

1. Check of DIODE MODULE

L1 - P1, L2 - P1, L3 - P1, L1 - N1, L2 - N1, L3 - N1

2. Check of DIP-IPM

P2 - U, P2 - V, P2 - W, N2 - U, N2 - V, N2 - W

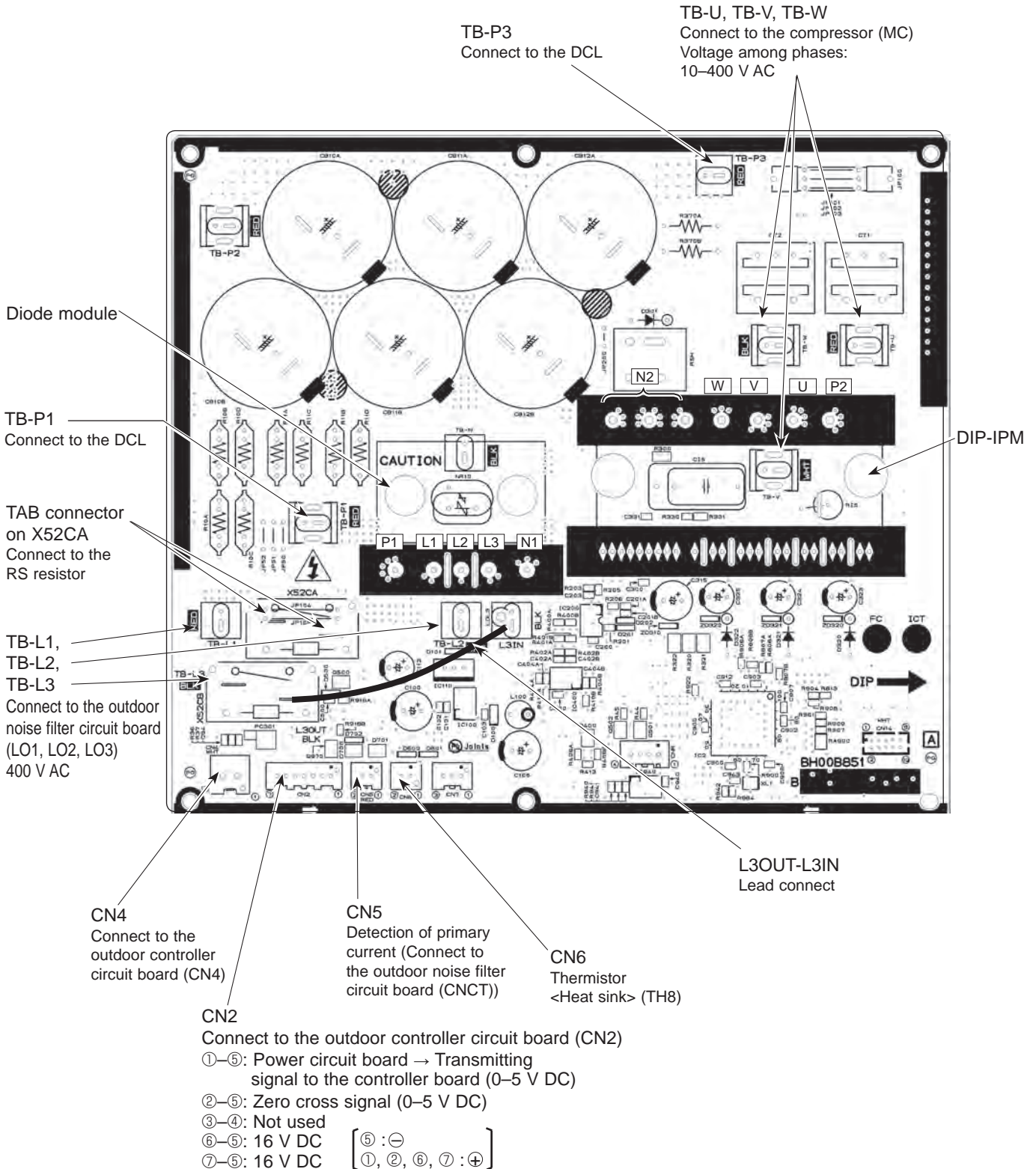

Note: The marks L1, L2, L3, N1, N2, P1, P2, U, V and W shown in the diagram are not actually printed on the board.



8-8. FUNCTION OF SWITCHES, CONNECTORS AND JUMPERS

Function of switches

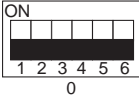
The black square (■) indicates a switch position.

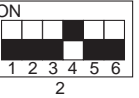
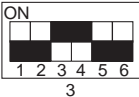
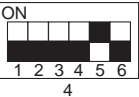
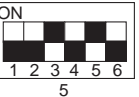
Type of switch	Switch No.	Function	Action by the switch operation		Effective timing	
			ON	OFF		
DIP switch	SW1	1	Manual defrost*1	Start	Normal	When compressor is working in heating operation.*1
		2	Abnormal history clear	Clear	Normal	OFF or operating
		3	Refrigerant address setting		0	When power supply ON
		4			1	
		5			2	
		6			3	
	1		4			
	2		5			
				Note: Up to 6 refrigerant address can be assigned.		
	SW4	1	Test run	Operating	OFF	Under suspension
		2	Test run mode setting	Heating	Cooling	
SW8	1	No function	—	—	—	
	2	Setting of short pipe connection	Used	Not used	When power supply ON	
	3	No function	—	—	—	
Push switch	SWP	Pump down	Start	Normal	Under suspension	

*1 Manual defrost should be done as follows.

① Change the DIP SW1-1 on the outdoor controller board from OFF to ON.

② Manual defrost will start by the above operation ① if all these conditions written below are satisfied.

- Heat mode setting
- 10 minutes have passed since compressor started operating or previous manual defrost is finished.
- Pipe temperature is less than or equal to 8°C.

Manual defrost will finish if certain conditions have been satisfied.

Manual defrost can be done if above conditions have been satisfied when DIP SW1-1 is changed from OFF to ON.

After DIP SW1-1 is changed from OFF to ON, there is no problem if DIP SW1-1 is left ON or changed to OFF again. This depends on the service conditions.

Continue to the next page

The black square (■) indicates a switch position.

Type of Switch	Switch	No.	Function	Action by the switch operation		Effective timing																																																																																																		
				ON	OFF																																																																																																			
DIP switch	SW5	1	No function	—	—	—																																																																																																		
		2	Power failure automatic recovery*1	Auto recovery	No auto recovery	When power supply ON																																																																																																		
		3,4,5	No function	—	—	—																																																																																																		
		6	Model select	Following SW5-6 reference																																																																																																				
	SW7*3	1	Mode select*2	Demand function	Low noise mode	Always																																																																																																		
		2	No function	—	—	—																																																																																																		
		3	Defrost Hz setting	Defrost Hz × 0.54	Normal	Always																																																																																																		
		4	No function	—	—	—																																																																																																		
		5	No function	—	—	—																																																																																																		
		6	Defrost setting	For high humidity	Normal	Always																																																																																																		
	SW9	1	No function	—	—	—																																																																																																		
		2	Function switch	Valid	Normal	Always																																																																																																		
		3,4	Starting Ambient temp. of flash injection	SW9-3	SW9-4	Ambient temp.	Always																																																																																																	
				OFF	OFF	≤ 3°C (Initial setting)																																																																																																		
	OFF	ON	≤ 0°C																																																																																																					
	ON	OFF	≤ -3°C																																																																																																					
	ON	ON	≤ -6°C																																																																																																					
	SW6	SW6	1	Model select	<table border="1"> <thead> <tr> <th>MODELS</th> <th>SW6</th> <th>SW5-6</th> </tr> </thead> <tbody> <tr> <td>PUHZ-SHW230YKA2 PUHZ-SHW230YKA2R1</td> <td> <table border="1"> <tr><td>ON</td><td>■</td><td>■</td><td>■</td><td>■</td><td>■</td><td>■</td><td>■</td></tr> <tr><td>OFF</td><td>□</td><td>□</td><td>□</td><td>□</td><td>□</td><td>□</td><td>□</td></tr> <tr><td></td><td>1</td><td>2</td><td>3</td><td>4</td><td>5</td><td>6</td><td>7</td><td>8</td></tr> </table> </td> <td> <table border="1"> <tr><td>ON</td><td>■</td><td>■</td><td>■</td><td>■</td><td>■</td></tr> <tr><td>OFF</td><td>□</td><td>□</td><td>□</td><td>□</td><td>□</td></tr> <tr><td></td><td>1</td><td>2</td><td>3</td><td>4</td><td>5</td><td>6</td></tr> </table> </td> </tr> <tr> <td>PUHZ-SHW230YKA2R2</td> <td> <table border="1"> <tr><td>ON</td><td>■</td><td>■</td><td>■</td><td>■</td><td>■</td><td>■</td><td>■</td></tr> <tr><td>OFF</td><td>□</td><td>□</td><td>□</td><td>□</td><td>□</td><td>□</td><td>□</td></tr> <tr><td></td><td>1</td><td>2</td><td>3</td><td>4</td><td>5</td><td>6</td><td>7</td><td>8</td></tr> </table> </td> <td> <table border="1"> <tr><td>ON</td><td>■</td><td>■</td><td>■</td><td>■</td><td>■</td></tr> <tr><td>OFF</td><td>□</td><td>□</td><td>□</td><td>□</td><td>□</td></tr> <tr><td></td><td>1</td><td>2</td><td>3</td><td>4</td><td>5</td><td>6</td></tr> </table> </td> </tr> </tbody> </table>			MODELS	SW6	SW5-6	PUHZ-SHW230YKA2 PUHZ-SHW230YKA2R1	<table border="1"> <tr><td>ON</td><td>■</td><td>■</td><td>■</td><td>■</td><td>■</td><td>■</td><td>■</td></tr> <tr><td>OFF</td><td>□</td><td>□</td><td>□</td><td>□</td><td>□</td><td>□</td><td>□</td></tr> <tr><td></td><td>1</td><td>2</td><td>3</td><td>4</td><td>5</td><td>6</td><td>7</td><td>8</td></tr> </table>	ON	■	■	■	■	■	■	■	OFF	□	□	□	□	□	□	□		1	2	3	4	5	6	7	8	<table border="1"> <tr><td>ON</td><td>■</td><td>■</td><td>■</td><td>■</td><td>■</td></tr> <tr><td>OFF</td><td>□</td><td>□</td><td>□</td><td>□</td><td>□</td></tr> <tr><td></td><td>1</td><td>2</td><td>3</td><td>4</td><td>5</td><td>6</td></tr> </table>	ON	■	■	■	■	■	OFF	□	□	□	□	□		1	2	3	4	5	6	PUHZ-SHW230YKA2R2	<table border="1"> <tr><td>ON</td><td>■</td><td>■</td><td>■</td><td>■</td><td>■</td><td>■</td><td>■</td></tr> <tr><td>OFF</td><td>□</td><td>□</td><td>□</td><td>□</td><td>□</td><td>□</td><td>□</td></tr> <tr><td></td><td>1</td><td>2</td><td>3</td><td>4</td><td>5</td><td>6</td><td>7</td><td>8</td></tr> </table>	ON	■	■	■	■	■	■	■	OFF	□	□	□	□	□	□	□		1	2	3	4	5	6	7	8	<table border="1"> <tr><td>ON</td><td>■</td><td>■</td><td>■</td><td>■</td><td>■</td></tr> <tr><td>OFF</td><td>□</td><td>□</td><td>□</td><td>□</td><td>□</td></tr> <tr><td></td><td>1</td><td>2</td><td>3</td><td>4</td><td>5</td><td>6</td></tr> </table>	ON	■	■	■	■	■	OFF	□	□	□	□	□		1	2	3	4	5	6
			MODELS		SW6	SW5-6																																																																																																		
			PUHZ-SHW230YKA2 PUHZ-SHW230YKA2R1		<table border="1"> <tr><td>ON</td><td>■</td><td>■</td><td>■</td><td>■</td><td>■</td><td>■</td><td>■</td></tr> <tr><td>OFF</td><td>□</td><td>□</td><td>□</td><td>□</td><td>□</td><td>□</td><td>□</td></tr> <tr><td></td><td>1</td><td>2</td><td>3</td><td>4</td><td>5</td><td>6</td><td>7</td><td>8</td></tr> </table>	ON	■	■	■	■	■	■	■	OFF	□	□	□	□	□	□	□		1	2	3	4	5	6	7	8	<table border="1"> <tr><td>ON</td><td>■</td><td>■</td><td>■</td><td>■</td><td>■</td></tr> <tr><td>OFF</td><td>□</td><td>□</td><td>□</td><td>□</td><td>□</td></tr> <tr><td></td><td>1</td><td>2</td><td>3</td><td>4</td><td>5</td><td>6</td></tr> </table>	ON	■	■	■	■	■	OFF	□	□	□	□	□		1	2	3	4	5	6																																																						
			ON		■	■	■	■	■	■	■																																																																																													
			OFF		□	□	□	□	□	□	□																																																																																													
					1	2	3	4	5	6	7	8																																																																																												
			ON		■	■	■	■	■																																																																																															
OFF			□		□	□	□	□																																																																																																
		1	2	3	4	5	6																																																																																																	
PUHZ-SHW230YKA2R2		<table border="1"> <tr><td>ON</td><td>■</td><td>■</td><td>■</td><td>■</td><td>■</td><td>■</td><td>■</td></tr> <tr><td>OFF</td><td>□</td><td>□</td><td>□</td><td>□</td><td>□</td><td>□</td><td>□</td></tr> <tr><td></td><td>1</td><td>2</td><td>3</td><td>4</td><td>5</td><td>6</td><td>7</td><td>8</td></tr> </table>	ON	■	■	■	■	■	■	■	OFF	□	□	□	□	□	□	□		1	2	3	4	5	6	7	8	<table border="1"> <tr><td>ON</td><td>■</td><td>■</td><td>■</td><td>■</td><td>■</td></tr> <tr><td>OFF</td><td>□</td><td>□</td><td>□</td><td>□</td><td>□</td></tr> <tr><td></td><td>1</td><td>2</td><td>3</td><td>4</td><td>5</td><td>6</td></tr> </table>	ON	■	■	■	■	■	OFF	□	□	□	□	□		1	2	3	4	5	6																																																									
ON	■	■	■	■	■	■	■																																																																																																	
OFF	□	□	□	□	□	□	□																																																																																																	
	1	2	3	4	5	6	7	8																																																																																																
ON	■	■	■	■	■																																																																																																			
OFF	□	□	□	□	□																																																																																																			
	1	2	3	4	5	6																																																																																																		
2																																																																																																								
3																																																																																																								
4																																																																																																								
5																																																																																																								
6																																																																																																								
7																																																																																																								
8																																																																																																								
SW5	6																																																																																																							

*1 "Power failure automatic recovery" can be set by either remote controller or this DIP SW. If one of them is set to ON, "Auto recovery" activates. Please set "Auto recovery" basically by remote controller because all units do not have DIP SW. Please refer to the indoor unit installation manual.

*2 SW7-1 is setting change over of Demand/Low noise. It is effective only in case of external input. (Local wiring is necessary. Refer to the next page: Special function)

*3 Please do not use SW7-3, 4, 6 usually. Trouble might be caused by the usage condition.

(2) Function of connector

Types	Connector	Function	Action by open/ short operation		Effective timing
			Short	Open	
Connector	CN31	Emergency operation	Start	Normal	When power supply ON

Special function

(a) Low-level sound priority mode (Local wiring)

By performing the following modification, operation noise of the outdoor unit can be reduced by about 3-4 dB.

The low noise mode will be activated when a commercially available timer or the contact input of an ON/OFF switch is added to the CNDM connector (option) on the control board of the outdoor unit.

• The ability varies according to the outdoor temperature and conditions, etc.

① Complete the circuit as shown when using the external input adapter (PAC-SC36NA-E). (Option)

② SW7-1 (Outdoor unit control board): OFF

③ SW1 ON: Low noise mode

SW1 OFF: Normal operation

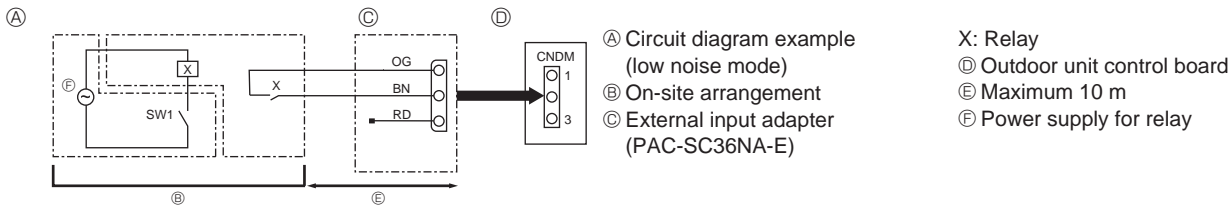

(b) On demand control (Local wiring) (Only for Air-conditioners)

By performing the following modification, energy consumption can be reduced to 0–100% of the normal consumption.

The demand function will be activated when a commercially available timer or the contact input of an ON/OFF switch is added to the CNDM connector (option) on the control board of the outdoor unit.

① Complete the circuit as shown when using the external input adapter (PAC-SC36NA-E). (Option)

② By setting SW7-1 on the control board of the outdoor unit, the energy consumption (compared to the normal consumption) can be limited as shown below.

	SW7-1	SW2	SW3	Energy consumption
Demand function	ON	OFF	OFF	100%
		ON	OFF	75%
		ON	ON	50%
		OFF	ON	0% (Stop)

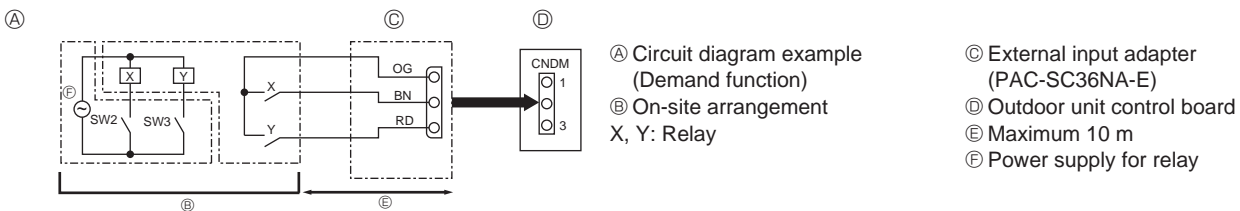

<Display function of inspection for outdoor unit>

The blinking patterns of both LED1 (green) and LED2 (red) indicate the types of abnormality when it occurs. Types of abnormality can be indicated in details by connecting an optional part "A-Control Service Tool (PAC-SK52ST)" to connector CNM on outdoor controller board.

[Display]

(1) Normal condition

Unit condition	Outdoor controller board		A-Control Service Tool	
	LED1 (Green)	LED2 (Red)	Check code	Indication of the display
When the power is turned on	Lit	Lit	— ⇄ —	Alternately blinking display
When unit stops	Lit	Not lit	00, etc.	Operation mode
When compressor is warming up	Lit	Not lit	08, etc.	
When unit operates	Lit	Lit	C5, H7, etc.	

(2) Abnormal condition

Indication		Contents	Check code *1	Error Inspection method	
Outdoor controller board LED1 (Green)	LED2 (Red)				
1 blinking	2 blinking	Connector(63L) is open.	F3	①Check if connector (63H or 63L) on the outdoor controller board is not disconnected. ②Check continuity of pressure switch (63H or 63L) by tester.	
		Connector(63H) is open.	F5		
		2 connectors are open.	F9		
2 blinking	1 blinking	Miswiring of I/F or FTC or outdoor unit connecting wire, excessive number of indoor units (4 units or more)	—	①Check if I/F or FTC or outdoor connecting wire is connected correctly. ②Check if 4 or more I/F or FTC units are connected to outdoor unit. ③Check if noise entered into I/F or FTC or outdoor connecting wire or power supply. ④Re-check error by turning off power, and on again.	
		Miswiring of I/F or FTC or outdoor unit connecting wire (reverse wiring or disconnection)	—		
		Startup time over	—		
	2 blinking	I/F or FTC or outdoor unit communication error (signal receiving error) is detected by FTC unit.	E6		①Check if I/F or FTC or outdoor connecting wire is connected correctly. ②Check if noise entered into I/F or FTC or outdoor connecting wire or power supply. ③Check if noise entered into I/F or FTC or outdoor controller board. ④Re-check error by turning off power, and on again.
		I/F or FTC or outdoor unit communication error (signal receiving error) is detected by outdoor unit.	(E8)		
		I/F or FTC or outdoor unit communication error (transmitting error) is detected by outdoor unit.	(E9)		
	3 blinking		Remote controller signal receiving error is detected by remote controller.	E0	①Check if connecting wire of I/F or FTC unit or remote controller is connected correctly. ②Check if noise entered into transmission wire of remote controller. ③Re-check error by turning off power, and on again.
			Remote controller transmitting error is detected by remote controller.	E3	
			Remote controller signal receiving error is detected by I/F or FTC unit.	E4	
Remote controller transmitting error is detected by I/F or FTC unit.			E5		
4 blinking		Check code is not defined.	EF	①Check if noise entered into transmission wire of remote controller. ②Check if noise entered into I/F or FTC or outdoor connecting wire. ③Re-check error by turning off power, and on again.	

*1 Check code displayed on remote controller

*2 Refer to Technical manual of ATW, I/F, FTC.

Continue to the next page

Indication		Error			
Outdoor controller board		Contents	Check code *1	Inspection method	
LED1 (Green)	LED2 (Red)				
3 blinking	1 blinking	Abnormality of comp. surface temperature (TH34) and discharging temperature (TH4)	U2	①Check if stop valves are open. ②Check if connectors (TH4, TH34, LEV-A, and LEV-B) on outdoor controller board are not disconnected. ③Check if unit is filled with specified amount of refrigerant. ④Measure resistance values among terminals on indoor valve and outdoor linear expansion valve using a tester.	
		Abnormality of superheat due to low discharge temperature	U7		
	2 blinking	Abnormal high pressure (High pressure switch 63H operated.)	U1	①Check if outdoor unit have a short cycle on their air ducts. ②Check if connector (63H)(63L) on outdoor controller board is not disconnected. ③Check if heat exchanger and filter is not dirty. ④Measure resistance values among terminals on linear expansion valve using a tester.	
		Abnormal low pressure (Low pressure switch 63L operated.)	UL		
	3 blinking	Abnormality of outdoor fan motor rotational speed	U8	①Check the outdoor fan motor. ②Check if connector (TH3) (63HS) on outdoor controller board is disconnected.	
		Protection from overheat operation (TH3), (T _{63HS})	Ud		
	4 blinking	Compressor overcurrent breaking(Startup locked)	Compressor overcurrent breaking	UF	①Check if stop valves are open. ②Check looseness, disconnection, and reverse connection of compressor wiring. ③Measure resistance values among terminals on compressor using a tester. ④Check if outdoor unit has a short cycle on its air duct. ⑤Check leakage of refrigerant.
			Compressor overcurrent breaking	UP	
			Abnormality of current sensor (P.B.)	UH	
			Abnormality of power module	U6	
	5 blinking	Open/short of outdoor thermistors (TH4, TH34)	Open/short of outdoor thermistors (TH4, TH34)	U3	①Check if connectors (TH3,TH32,TH4, TH34 and TH7/6) on outdoor controller board and connector (CN3) on outdoor power board are not disconnected. ②Measure resistance value of outdoor thermistors.
			Open/short of outdoor thermistors (TH3, TH32, TH6, TH7 and TH8)	U4	
	6 blinking	Abnormality of heat sink temperature	U5	①Check if outdoor unit have a short cycle on their air ducts. ②Measure resistance value of outdoor thermistor (TH8).	
	7 blinking	Abnormality of voltage	U9	①Check looseness, disconnection, and reverse connection of compressor wiring. ②Measure resistance value among terminals on compressor using a tester. ③Check if power supply voltage decreases.	
4 blinking	1 blinking	Abnormality of water temperature thermistor (TH1)	P1	①Check if terminal on I/F or FTC are not disconnected. ②Measure resistance value of I/F or FTC thermistors.	
		Abnormality of pipe temperature thermistor / Liquid (TH2)	P2		
		Abnormality of actual tank temperature thermistor (TH5)	P9		
	3 blinking	Freezing (cooling)/overheating (heating, heating ECO, anti freeze, hot water) protection	P6	①Check if short cycle of air path. ②Check if heat exchanger and filter is not dirty. ③Measure resistance value on outdoor fan motor. ④Check if the inside of refrigerant piping is not clogged.	

*1 Check code displayed on remote controller

*2 Refer to Technical manual of ATW, I/F, FTC.

<Outdoor unit operation monitor function>



[When optional part "A-Control Service Tool (PAC-SK52ST)" is connected to outdoor controller board (CNM)]

Digital indicator LED1 displays 2 digit number or code to inform operation condition and the meaning of check code by controlling DIP SW2 on "A-Control Service Tool".

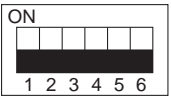
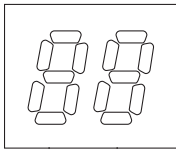
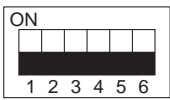
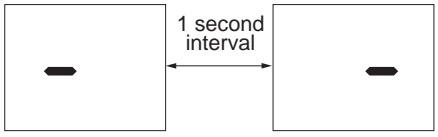
Operation indicator SW2 : Indicator change of self-diagnosis

SW2 setting	Display detail	Explanation for display	Unit																																																																																																																									
	<p><Digital indicator LED1 working details> (Be sure that 1 to 6 in the SW2 are set to OFF.)</p> <p>(1) Display when the power supply ON When the power supply ON, blinking displays by turns. Wait for 4 minutes at the longest.</p> <p>(2) When the display lights (Normal operation)</p> <p>① Operation mode display.</p> <div style="display: flex; align-items: center;"> <div style="text-align: center;">  <p>(Lighting)</p> </div> <div style="margin-left: 20px;">  </div> </div> <div style="display: flex; justify-content: space-around; margin-top: 10px;"> <div style="text-align: center;"> <p>The tens digit : Operation mode</p> <table border="1" style="margin: auto;"> <thead> <tr> <th>Display</th> <th>Operation Model</th> </tr> </thead> <tbody> <tr><td>O</td><td>OFF/FAN</td></tr> <tr><td>C</td><td>COOLING/DRY</td></tr> <tr><td>H</td><td>HEATING</td></tr> <tr><td>d</td><td>DEFROSTING</td></tr> </tbody> </table> </div> <div style="text-align: center;"> <p>The ones digit : Relay output</p> <table border="1" style="margin: auto;"> <thead> <tr> <th>Display</th> <th>Warming-up Compressor</th> <th>Compressor</th> <th>4-way valve</th> <th>Solenoid valve</th> </tr> </thead> <tbody> <tr><td>0</td><td>—</td><td>—</td><td>—</td><td>—</td></tr> <tr><td>1</td><td>—</td><td>—</td><td>—</td><td>ON</td></tr> <tr><td>2</td><td>—</td><td>—</td><td>ON</td><td>—</td></tr> <tr><td>3</td><td>—</td><td>—</td><td>ON</td><td>ON</td></tr> <tr><td>4</td><td>—</td><td>ON</td><td>—</td><td>—</td></tr> <tr><td>5</td><td>—</td><td>ON</td><td>—</td><td>ON</td></tr> <tr><td>6</td><td>—</td><td>ON</td><td>ON</td><td>—</td></tr> <tr><td>7</td><td>—</td><td>ON</td><td>ON</td><td>ON</td></tr> <tr><td>8</td><td>ON</td><td>—</td><td>—</td><td>—</td></tr> <tr><td>A</td><td>ON</td><td>—</td><td>ON</td><td>—</td></tr> </tbody> </table> </div> </div> <p>② Display during error postponement Postponement code is displayed when compressor stops due to the work of protection device. Postponement code is displayed while error is being postponed.</p> <p>(3) When the display blinks Check code is displayed when compressor stops due to the work of protection devices.</p> <table border="1" style="margin: 20px auto;"> <thead> <tr> <th>Display</th> <th>Contents to be inspected (During operation)</th> </tr> </thead> <tbody> <tr><td>U1</td><td>Abnormal high pressure (63H operated)</td></tr> <tr><td>U2</td><td>Abnormal high discharging temperature, high comp. surface temperature , shortage of refrigerant</td></tr> <tr><td>U3</td><td>Open/short of outdoor unit thermistors (TH4, TH34)</td></tr> <tr><td>U4</td><td>Open/short of outdoor unit thermistors (TH3, TH32, TH6, TH7 and TH8)</td></tr> <tr><td>U5</td><td>Abnormal temperature of heat sink</td></tr> <tr><td>U6</td><td>Abnormality of power module</td></tr> <tr><td>U7</td><td>Abnormality of superheat due to low discharge temperature</td></tr> <tr><td>U8</td><td>Abnormality in outdoor fan motor</td></tr> <tr><td>Ud</td><td>Overheat protection</td></tr> <tr><td>UF</td><td>Compressor overcurrent interruption (When Comp. locked)</td></tr> <tr><td>UH</td><td>Current sensor error</td></tr> <tr><td>UL</td><td>Abnormal low pressure (63L operated)</td></tr> <tr><td>UP</td><td>Compressor overcurrent interruption</td></tr> <tr><td>P1–P9</td><td>Abnormality of Interface or FTC units</td></tr> </tbody> </table> <table border="1" style="margin: 20px auto;"> <thead> <tr> <th>Display</th> <th>Inspection unit</th> </tr> </thead> <tbody> <tr><td>0</td><td>Outdoor unit</td></tr> <tr><td>1</td><td>Interface or FTC</td></tr> </tbody> </table> <table border="1" style="margin: 20px auto;"> <thead> <tr> <th>Display</th> <th>Contents to be inspected (When power is turned on)</th> </tr> </thead> <tbody> <tr><td>F3</td><td>63L connector (red) is open.</td></tr> <tr><td>F5</td><td>63H connector(yellow) is open.</td></tr> <tr><td>F9</td><td>2 connectors(63H/63L) are open.</td></tr> <tr><td>E8</td><td>Interface or FTC/outdoor communication error (Signal receiving error) (Outdoor unit)</td></tr> <tr><td>E9</td><td>Interface or FTC/outdoor communication error (Transmitting error) (Outdoor unit)</td></tr> <tr><td>EA</td><td>Miswiring of Interface or FTC/outdoor unit connecting wire</td></tr> <tr><td>Eb</td><td>Miswiring of Interface or FTC/outdoor unit connecting wire (reverse wiring or disconnection)</td></tr> <tr><td>EC</td><td>Startup time over</td></tr> <tr><td>E0–E6</td><td>Communication error except for outdoor unit</td></tr> </tbody> </table>	Display	Operation Model	O	OFF/FAN	C	COOLING/DRY	H	HEATING	d	DEFROSTING	Display	Warming-up Compressor	Compressor	4-way valve	Solenoid valve	0	—	—	—	—	1	—	—	—	ON	2	—	—	ON	—	3	—	—	ON	ON	4	—	ON	—	—	5	—	ON	—	ON	6	—	ON	ON	—	7	—	ON	ON	ON	8	ON	—	—	—	A	ON	—	ON	—	Display	Contents to be inspected (During operation)	U1	Abnormal high pressure (63H operated)	U2	Abnormal high discharging temperature, high comp. surface temperature , shortage of refrigerant	U3	Open/short of outdoor unit thermistors (TH4, TH34)	U4	Open/short of outdoor unit thermistors (TH3, TH32, TH6, TH7 and TH8)	U5	Abnormal temperature of heat sink	U6	Abnormality of power module	U7	Abnormality of superheat due to low discharge temperature	U8	Abnormality in outdoor fan motor	Ud	Overheat protection	UF	Compressor overcurrent interruption (When Comp. locked)	UH	Current sensor error	UL	Abnormal low pressure (63L operated)	UP	Compressor overcurrent interruption	P1–P9	Abnormality of Interface or FTC units	Display	Inspection unit	0	Outdoor unit	1	Interface or FTC	Display	Contents to be inspected (When power is turned on)	F3	63L connector (red) is open.	F5	63H connector(yellow) is open.	F9	2 connectors(63H/63L) are open.	E8	Interface or FTC/outdoor communication error (Signal receiving error) (Outdoor unit)	E9	Interface or FTC/outdoor communication error (Transmitting error) (Outdoor unit)	EA	Miswiring of Interface or FTC/outdoor unit connecting wire	Eb	Miswiring of Interface or FTC/outdoor unit connecting wire (reverse wiring or disconnection)	EC	Startup time over	E0–E6	Communication error except for outdoor unit		
Display	Operation Model																																																																																																																											
O	OFF/FAN																																																																																																																											
C	COOLING/DRY																																																																																																																											
H	HEATING																																																																																																																											
d	DEFROSTING																																																																																																																											
Display	Warming-up Compressor	Compressor	4-way valve	Solenoid valve																																																																																																																								
0	—	—	—	—																																																																																																																								
1	—	—	—	ON																																																																																																																								
2	—	—	ON	—																																																																																																																								
3	—	—	ON	ON																																																																																																																								
4	—	ON	—	—																																																																																																																								
5	—	ON	—	ON																																																																																																																								
6	—	ON	ON	—																																																																																																																								
7	—	ON	ON	ON																																																																																																																								
8	ON	—	—	—																																																																																																																								
A	ON	—	ON	—																																																																																																																								
Display	Contents to be inspected (During operation)																																																																																																																											
U1	Abnormal high pressure (63H operated)																																																																																																																											
U2	Abnormal high discharging temperature, high comp. surface temperature , shortage of refrigerant																																																																																																																											
U3	Open/short of outdoor unit thermistors (TH4, TH34)																																																																																																																											
U4	Open/short of outdoor unit thermistors (TH3, TH32, TH6, TH7 and TH8)																																																																																																																											
U5	Abnormal temperature of heat sink																																																																																																																											
U6	Abnormality of power module																																																																																																																											
U7	Abnormality of superheat due to low discharge temperature																																																																																																																											
U8	Abnormality in outdoor fan motor																																																																																																																											
Ud	Overheat protection																																																																																																																											
UF	Compressor overcurrent interruption (When Comp. locked)																																																																																																																											
UH	Current sensor error																																																																																																																											
UL	Abnormal low pressure (63L operated)																																																																																																																											
UP	Compressor overcurrent interruption																																																																																																																											
P1–P9	Abnormality of Interface or FTC units																																																																																																																											
Display	Inspection unit																																																																																																																											
0	Outdoor unit																																																																																																																											
1	Interface or FTC																																																																																																																											
Display	Contents to be inspected (When power is turned on)																																																																																																																											
F3	63L connector (red) is open.																																																																																																																											
F5	63H connector(yellow) is open.																																																																																																																											
F9	2 connectors(63H/63L) are open.																																																																																																																											
E8	Interface or FTC/outdoor communication error (Signal receiving error) (Outdoor unit)																																																																																																																											
E9	Interface or FTC/outdoor communication error (Transmitting error) (Outdoor unit)																																																																																																																											
EA	Miswiring of Interface or FTC/outdoor unit connecting wire																																																																																																																											
Eb	Miswiring of Interface or FTC/outdoor unit connecting wire (reverse wiring or disconnection)																																																																																																																											
EC	Startup time over																																																																																																																											
E0–E6	Communication error except for outdoor unit																																																																																																																											

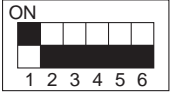
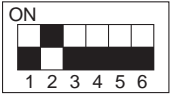
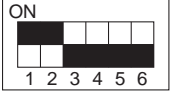
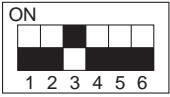
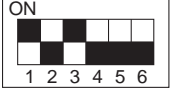
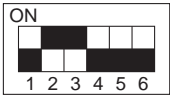
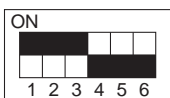
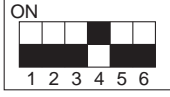
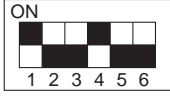
The black square (■) indicates a switch position.

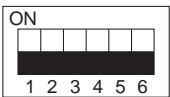
SW2 setting	Display detail	Explanation for display	Unit
	Pipe temperature/Liquid (TH3) -40 to 90	-40 to 90 (When the coil thermistor detects 0°C or below, “-” and temperature are displayed by turns.) (Example) When -10°C; 0.5 s 0.5 s 2 s -□ → 10 → □□	°C
	Discharge temperature (TH4) 3 to 217	3 to 217 (When the discharge thermistor detects 100°C or more, hundreds digit, tens digit and ones digit are displayed by turns.) (Example) When 105°C; 0.5 s 0.5 s 2 s □1 → 05 → □□	°C
	Output step of outdoor FAN 0 to 10	0 to 10	Step
	The number of ON / OFF times of compressor 0 to 9999	0 to 9999 (When the number of times is 100 or more, hundreds digit, tens digit and ones digit are displayed by turns.) (Example) When 42500 times (425 × 100 times); 0.5 s 0.5 s 2 s □4 → 25 → □□	100 times
	Compressor integrating operation times 0 to 9999	0 to 9999 (When it is 100 hours or more, hundreds digit, tens digit and ones digit are displayed by turns.) (Example) When 2450 hours (245 × 10 hours); 0.5 s 0.5 s 2 s □2 → 45 → □□	10 hours
	Compressor operating current 0 to 50	0 to 50 Note: Omit the figures after the decimal fractions.	A
	Compressor operating frequency 0 to 225	0 to 255 (When it is 100 Hz or more, hundreds digit, tens digit and ones digit are displayed by turns.) (Example) When 125 Hz; 0.5 s 0.5 s 2 s □1 → 25 → □□	Hz
	LEV-A opening pulse 0 to 480	0 to 480 (When it is 100 pulse or more, hundreds digit, tens digit and ones digit are displayed by turns.) (Example) When 150 pulse; 0.5 s 0.5 s 2 s □1 → 50 → □□	Pulse
	Error postponement code history (1) of outdoor unit	Postponement code display Blinking: During postponement Lighting: Cancellation of postponement “00” is displayed in case of no postponement.	Code display
	Operation mode on error occurring	Operation mode of when operation stops due to error is displayed by setting SW2 like below. (SW2) 	Code display

The black square (■) indicates a switch position.

SW2 setting	Display detail	Explanation for display	Unit
	Pipe temperature/Liquid (TH3) on error occurring -40 to 90	-40 to 90 (When the coil thermistor detects 0°C or below, “-” and temperature are displayed by turns.) (Example) When -15°C; 0.5 s 0.5 s 2 s -□ → 15 → □□ ↑	°C
	Discharge temperature (TH4) on error occurring 3 to 217	3 to 217 (When the temperature is 100°C or more, the hundreds digit, tens digit and ones digit are displayed by turns.) (Example) When 130°C; 0.5 s 0.5 s 2 s □1 → 30 → □□ ↑	°C
	Compressor operating current on error occurring 0 to 20	0 to 20	A
	Error history (1) (latest) Alternate display of abnormal unit number and code	When no error history, “ 0 ” and “ - - ” are displayed by turns.	Code display
	Error history (2) Alternate display of error unit number and code	When no error history, “ 0 ” and “ - - ” are displayed by turns.	Code display
	Thermo-ON time 0 to 999	0 to 999 (When it is 100 minutes or more, the hundreds digit, tens digit and ones digit are displayed by turns.) (Example) When 245 minutes; 0.5 s 0.5 s 2 s □2 → 45 → □□ ↑	Minute
	Test run elapsed time 0 to 120	0 to 120 (When it is 100 minutes or more, the hundreds digit, tens digit and ones digit are displayed by turns.) (Example) When 105 minutes; 0.5 s 0.5 s 2 s □1 → 05 → □□ ↑	Minute

The black square (■) indicates a switch position.

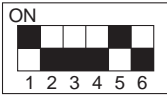
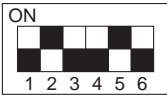
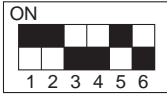
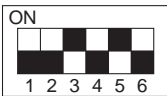
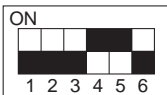
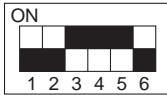
SW2 setting	Display detail	Explanation for display	Unit										
	The number of connected indoor units	0 to 3 (The number of connected indoor units is displayed.)	Unit										
	Capacity setting display	Displayed as an outdoor capacity code. <table border="1" data-bbox="759 512 1042 580"> <tr> <th>Model</th> <th>Code</th> </tr> <tr> <td>SHW230</td> <td>40</td> </tr> </table>	Model	Code	SHW230	40	Code display						
Model	Code												
SHW230	40												
	Outdoor unit setting information	<ul style="list-style-type: none"> The tens digit (Total display for applied setting) <table border="1" data-bbox="751 757 1315 880"> <thead> <tr> <th>Setting details</th> <th>Display details</th> </tr> </thead> <tbody> <tr> <td>H·P / Cooling only</td> <td>0 : H·P 1 : Cooling only</td> </tr> <tr> <td>Single phase / 3 phase</td> <td>0 : Single phase 2 : 3 phase</td> </tr> </tbody> </table> The ones digit <table border="1" data-bbox="751 936 1315 1016"> <thead> <tr> <th>Setting details</th> <th>Display details</th> </tr> </thead> <tbody> <tr> <td>Defrosting switch</td> <td>0 : Normal 1 : For high humidity</td> </tr> </tbody> </table> <p>(Example) When heat pump, 3 phase and defrosting (normal) are set up, "20" is displayed.</p>	Setting details	Display details	H·P / Cooling only	0 : H·P 1 : Cooling only	Single phase / 3 phase	0 : Single phase 2 : 3 phase	Setting details	Display details	Defrosting switch	0 : Normal 1 : For high humidity	Code display
Setting details	Display details												
H·P / Cooling only	0 : H·P 1 : Cooling only												
Single phase / 3 phase	0 : Single phase 2 : 3 phase												
Setting details	Display details												
Defrosting switch	0 : Normal 1 : For high humidity												
	Pipe temperature/Liquid (TH2) -39 to 88	-39 to 88 (When the temperature is 0°C or less, "-" and temperature are displayed by turns.)	°C										
	Actual flow water temperature (TH1) 8 to 39	8 to 39	°C										
	Pressure saturation temperature (T _{63HS}) -39 to 88	-39 to 88 (When the temperature is 0°C or less, "-" and temperature are displayed by turns.)	°C										

The black square (■) indicates a switch position.

SW2 setting	Display detail	Explanation for display	Unit														
	Ambient temperature (TH7) -39 to 88	-39 to 88 (When the temperature is 0°C or less, “-” and temperature are displayed by turns.)	°C														
	Outdoor heat sink temperature (TH8) -40 to 200	-40 to 200 (When the temperature is 0°C or less, “-” and temperature are displayed by turns.) (When the thermistor detects 100°C or more, hundreds digit, tens digit and ones digit are displayed by turns.)	°C														
	Discharge superheat SHd 0 to 255 [Cooling = TH4-T _{63HS} Heating = TH4-T _{63HS}]	0 to 255 (When the temperature is 100°C or more, hundreds digit, tens digit and ones digit are displayed by turns.)	°C														
	Number of defrost cycles 0 to FFFE	0 to FFFE (in hexadecimal notation) (When more than FF in hex (255 in decimal), the number is displayed in order of 16 ³ 's and 16 ² 's, and 16 ¹ 's and 16 ⁰ 's places. (Example) When 5000 cycles; 0.5 s 0.5 s 2 s □9 → C4 → □□	2 cycles														
	Input current of outdoor unit	0 to 500 (When it is 100 or more, hundreds digit, tens digit and ones digit are displayed by turns.)	0.1 A														
	LEV-B opening pulse 0 to 480	0 to 480 (When it is 100 pulse or more, hundreds digit, tens digit and ones digit are displayed by turns.)	Pulse														
	U9 error detail history (latest)	<table border="1"> <thead> <tr> <th>Description</th> <th>Display</th> </tr> </thead> <tbody> <tr> <td>Normal</td> <td>00</td> </tr> <tr> <td>Overvoltage error</td> <td>01</td> </tr> <tr> <td>Undervoltage error</td> <td>02</td> </tr> <tr> <td>Input current sensor error</td> <td>04</td> </tr> <tr> <td>L1-phase open error</td> <td>04</td> </tr> <tr> <td>Abnormal power synchronous signal</td> <td>08</td> </tr> </tbody> </table> <p>Display examples for multiple errors: Overvoltage (01) + Undervoltage (02) = 03 Undervoltage (02) + Power-sync signal error (08) = 0A</p>	Description	Display	Normal	00	Overvoltage error	01	Undervoltage error	02	Input current sensor error	04	L1-phase open error	04	Abnormal power synchronous signal	08	Code display
Description	Display																
Normal	00																
Overvoltage error	01																
Undervoltage error	02																
Input current sensor error	04																
L1-phase open error	04																
Abnormal power synchronous signal	08																
	DC bus voltage 180 to 370	180 to 370 (When it is 100 V or more, hundreds digit, tens digit and ones digit are displayed by turns.)	V														

The black square (■) indicates a switch position.

SW2 setting	Display detail	Explanation for display	Unit
	Capacity save 0 to 255 [When there is no setting of capacity save "100" is displayed.]	0 to 255 (When the capacity is 100% hundreds digit, tens digit and ones digit are displayed by turns.) (Example) When 100%; 0.5 s 0.5 s 2 s □1 →00 →□□	%
	Error postponement code history (2) of outdoor unit	Postponement code display Blinking: During postponement Lighting: Cancellation of postponement "00" is displayed in case of no postponement.	Code display
	Error postponement code history (3) of outdoor unit	Postponement code display Blinking: During postponement Lighting: Cancellation of postponement "00" is displayed in case of no postponement.	Code display
	Error history (3) (Oldest) Alternate display of abnormal unit number and code	When no error history, "0" and "--" are displayed by turns.	Code display
	Error thermistor display ["—" is displayed.]	3: Liquid pipe thermistor (TH3) 4: Discharge pipe thermistor (TH4) 6: 2-phase pipe thermistor (TH6) 7: Ambient temp. thermistor (TH7) 8: Heat sink thermistor (TH8) 32: Suction pipe thermistor (TH32) 34: Comp. surface thermistor (TH34)	Code display
	Operation frequency on error occurring 0 to 255	0 to 255 (When it is 100 Hz or more, hundreds digit, tens digit and ones digit are displayed by turns.) (Example) When 125 Hz; 0.5 s 0.5 s 2 s □1 →25 →□□	Hz
	Fan step on error occurring 0 to 10	0 to 10	Step
	LEV-A opening pulse on error occurring 0 to 480	0 to 480 (When it is 100 pulse or more, hundreds digit, tens digit and ones digit are displayed by turns.) (Example) When 130 pulse; 0.5 s 0.5 s 2 s □1 →30 →□□	Pulse
	Actual water temperature (TH1) on error occurring 8 to 39	8 to 39	°C

The black square (■) indicates a switch position.

SW2 setting	Display detail	Explanation for display	Unit
	Pipe temperature/Liquid (TH2) on error occurring -39 to 88	-39 to 88 (When the temperature is 0°C or less, “-” and temperature are displayed by turns.) (Example) When -15°C; 0.5 s 0.5 s 2 s -□ → 15 → □□ ↑—————↓	°C
	Pressure saturation temperature (T _{63HS}) on error occurring -39 to 88	-39 to 88 (When the temperature is 0°C or less, “-” and temperature are displayed by turns.) (Example) When -15°C; 0.5 s 0.5 s 2 s -□ → 15 → □□ ↑—————↓	°C
	Outdoor pipe temperature/2-phase. (TH6) on error occurring -39 to 88	-39 to 88 (When the temperature is 0°C or less, “-” and temperature are displayed by turns.) (Example) When -15°C; 0.5 s 0.5 s 2 s -□ → 15 → □□ ↑—————↓	°C
	Outdoor outside temperature (TH7) on error occurring -39 to 88	-39 to 88 (When the temperature is 0°C or less, “-” and temperature are displayed by turns.) (Example) When -15°C; 0.5 s 0.5 s 2 s -□ → 15 → □□ ↑—————↓	°C
	Outdoor heat sink temperature (TH8) on error occurring -40 to 200	-40 to 200 (When the temperature is 0°C or less, “-” and temperature are displayed by turns.) (When the temperature is 100°C or more, hundreds digit, tens digit and ones digit are displayed by turns.)	°C
	Discharge superheat on error occurring SHd 0 to 255 [Cooling = TH4-T _{63HS} Heating = TH4-T _{63HS}]	0 to 255 (When the temperature is 100°C or more, hundreds digit, tens digit and ones digit are displayed by turns.) (Example) When 150°C; 0.5 s 0.5 s 2 s □1 → 50 → □□ ↑—————↓	°C
	Sub cool on error occurring SC 0 to 130 [Cooling = T _{63HS} -TH3 Heating = T _{63HS} -TH2]	0 to 130 (When the temperature is 100°C or more, hundreds digit, tens digit and ones digit are displayed by turns.) (Example) When 115°C; 0.5 s 0.5 s 2 s □1 → 15 → □□ ↑—————↓	°C
	Thermo-ON time until error stops 0 to 999	0 to 999 (When it is 100 minutes or more, hundreds digit, tens digit and ones digit are displayed by turns.) (Example) When 415 minutes; 0.5 s 0.5 s 2 s □4 → 15 → □□ ↑—————↓	Minute

The black square (■) indicates a switch position.

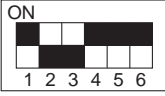
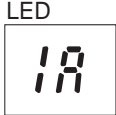
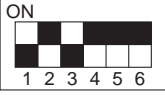
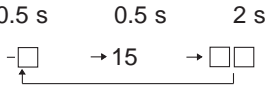
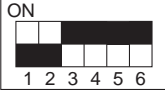
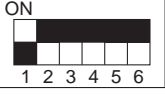
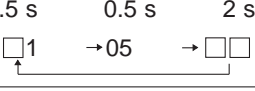
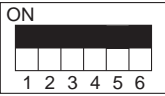
SW2 setting	Display detail	Explanation for display	Unit																
	Pipe temperature/Liquid (TH2 (3)) Indoor 3 -39 to 88	-39 to 88 (When the temperature is 0°C or less, “-” and temperature are displayed by turns.)	°C																
	Controlling status of compressor operating frequency	The following code will be a help to know the operating status of unit. •The tens digit <table border="1" data-bbox="775 544 1222 633"> <tr> <th>Display</th> <th>Compressor operating frequency control</th> </tr> <tr> <td>1</td> <td>Primary current control</td> </tr> <tr> <td>2</td> <td>Secondary current control</td> </tr> </table> •The ones digit (In this digit, the total number of activated control is displayed.) <table border="1" data-bbox="775 712 1222 954"> <tr> <th>Display</th> <th>Compressor operating frequency control</th> </tr> <tr> <td>1</td> <td>Preventive control for excessive temperature rise of discharge temperature</td> </tr> <tr> <td>2</td> <td>Preventive control for excessive temperature rise of condensing temperature</td> </tr> <tr> <td>4</td> <td>Frosting preventing control</td> </tr> <tr> <td>8</td> <td>Preventive control for excessive temperature rise of radiator panel</td> </tr> </table> (Example) The following controls are activated. • Primary current control • Preventive control for excessive temperature rise of condensing temperature • Preventive control for excessive temperature rise of heat sink 	Display	Compressor operating frequency control	1	Primary current control	2	Secondary current control	Display	Compressor operating frequency control	1	Preventive control for excessive temperature rise of discharge temperature	2	Preventive control for excessive temperature rise of condensing temperature	4	Frosting preventing control	8	Preventive control for excessive temperature rise of radiator panel	Code display
Display	Compressor operating frequency control																		
1	Primary current control																		
2	Secondary current control																		
Display	Compressor operating frequency control																		
1	Preventive control for excessive temperature rise of discharge temperature																		
2	Preventive control for excessive temperature rise of condensing temperature																		
4	Frosting preventing control																		
8	Preventive control for excessive temperature rise of radiator panel																		
	Outdoor suction pipe temperature (TH32) -39 to 88	-39 to 88 (When the temperature is 0°C or less, “-” and temperature are displayed by turns.) (Example) When -15°C; 0.5 s 0.5 s 2 s -□ → 15 → □□ 	°C																
	LEV-C opening pulse 0 to 480	0 to 480 (When it is 100 pulse or more, hundreds digit, tens digit and ones digit are displayed by turns.)	Pulse																
	Comp. surface thermistor (TH34) -52 to 221	-52 to 221 (When the temperature is 0°C or less, “-” and temperature are displayed by turns.) (When the discharge thermistor detects 100°C or more, hundreds digit, tens digit and ones digit are displayed by turns.) (Example) When 105°C; 0.5 s 0.5 s 2 s □1 → 05 → □□ 	°C																
	U9 error details (To be shown while error call is deferred.)	<table border="1" data-bbox="762 1861 1158 2067"> <thead> <tr> <th>Description</th> <th>Display</th> </tr> </thead> <tbody> <tr> <td>Normal</td> <td>00</td> </tr> <tr> <td>Overvoltage error</td> <td>01</td> </tr> <tr> <td>Undervoltage error</td> <td>02</td> </tr> <tr> <td>Input current sensor error</td> <td>04</td> </tr> <tr> <td>L1-phase open error</td> <td>04</td> </tr> <tr> <td>Abnormal power synchronous signal</td> <td>08</td> </tr> </tbody> </table> Display examples for multiple errors: Overvoltage (01) + Undervoltage (02) = 03 Undervoltage (02) + Power-sync signal error (08) = 0A	Description	Display	Normal	00	Overvoltage error	01	Undervoltage error	02	Input current sensor error	04	L1-phase open error	04	Abnormal power synchronous signal	08	Code display		
Description	Display																		
Normal	00																		
Overvoltage error	01																		
Undervoltage error	02																		
Input current sensor error	04																		
L1-phase open error	04																		
Abnormal power synchronous signal	08																		

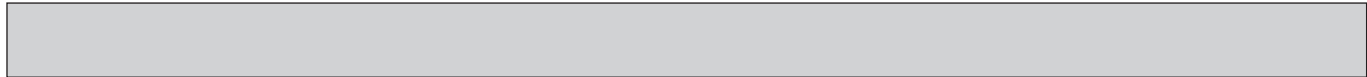

8-9. Request code list

Certain indoor/outdoor combinations do not have the request code function; therefore, no request codes are displayed. Refer to indoor unit service manual for how to use the controllers and request codes for indoor unit.

Request code	Request content	Description (Display range)	Unit	Remarks
0	Operation state	Refer to 8-9-1. Detail Contents in Request Code.	–	
1	Compressor-Operating current (rms)	0–50	A	
2	Compressor-Accumulated operating time	0–9999	10 hours	
3	Compressor-Number of operation times	0–9999	100 times	
4	Discharge temperature (TH4)	3–217	°C	
5	Outdoor unit -Liquid pipe 1 temperature (TH3)	–40–90	°C	
6				
7	Outdoor unit-2-phase pipe temperature (TH6)	–39–88	°C	
8	Outdoor unit-Suction pipe temperature (TH32)	–39–88	°C	
9	Outdoor unit-Outside air temperature (TH7)	–39–88	°C	
10	Outdoor unit-Heatsink temperature (TH8)	–40–200	°C	
11				
12	Discharge superheat (SHd)	0–255	°C	
13	Sub-cool (SC)	0–130	°C	
14	Condensing temperature (T _{63HS})	–39–88	°C	
15				
16	Compressor-Operating frequency	0–255	Hz	
17	Compressor-Target operating frequency	0–255	Hz	
18	Outdoor unit-Fan output step	0–10	Step	
19	Outdoor unit-Fan 1 speed (Only for air conditioners with DC fan motor)	0–9999	rpm	
20	Outdoor unit-Fan 2 speed (Only for air conditioners with DC fan motor)	0–9999	rpm	"0" is displayed if the air conditioner is a single-fan type.
21				
22	LEV (A) opening	0–500	Pulses	
23	LEV (B) opening	0–500	Pulses	
24	LEV (C) opening	0–500	Pulses	
25	Primary current	0–50	A	
26	DC bus voltage	180–370	V	
27				
28				
29				
30				
31				
32				
33				
34				
35				
36				
37				
38				
39				
40				
41				
42				
43				
44				
45				
46				
47				
48	Thermostat ON operating time	0–999	Minutes	
49				

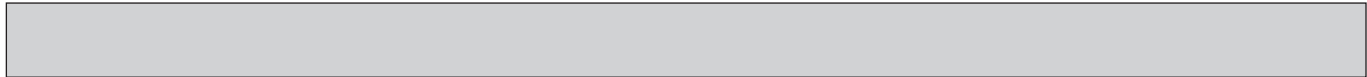

Request code	Request content	Description (Display range)	Unit	Remarks
50			—	
51	Outdoor unit-Control state	Refer to 8-9-1.Detail Contents in Request Code.	—	
52	Compressor-Frequency control state	Refer to 8-9-1.Detail Contents in Request Code.	—	
53	Outdoor unit-Fan control state	Refer to 8-9-1.Detail Contents in Request Code.	—	
54	Actuator output state	Refer to 8-9-1.Detail Contents in Request Code.	—	
55	Error content (U9)	Refer to 8-9-1.Detail Contents in Request Code.	—	
56				
57				
58				
59				
60				
61				
62				
63				
64				
65				
66				
67				
68				
69				
70	Outdoor unit-Capacity setting display	Refer to 8-9-1.Detail Contents in Request Code.	—	
71	Outdoor unit-Setting information	Refer to 8-9-1.Detail Contents in Request Code.	—	
72				
73				
74				
75				
76				
77				
78				
79				
80				
81				
82				
83				
84				
85				
86				
87				
88				
89				
90	Outdoor unit-Microprocessor version information	Examples) Ver 5.01 → "0501"	Ver	
91	Outdoor unit-Microprocessor version information (sub No.)	Auxiliary information (displayed after version information) Examples) Ver 5.01 A000 → "A000"	—	
92				
93				
94				
95				
96				
97				
98				
99				
100	Outdoor unit - Error postponement history 1 (latest)	Displays postponement code. (" - " is displayed if no postponement code is present)	Code	
101	Outdoor unit - Error postponement history 2 (previous)	Displays postponement code. (" - " is displayed if no postponement code is present)	Code	
102	Outdoor unit - Error postponement history 3 (last but one)	Displays postponement code. (" - " is displayed if no postponement code is present)	Code	

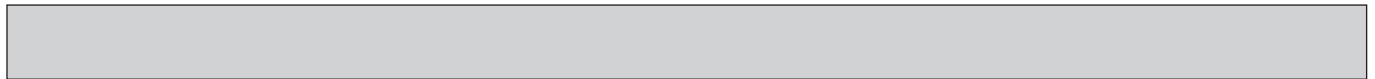

Request code	Request content	Description (Display range)	Unit	Remarks
103	Error history 1 (latest)	Displays error history. ("-" is displayed if no history is present.)	Code	
104	Error history 2 (second to last)	Displays error history. ("-" is displayed if no history is present.)	Code	
105	Error history 3 (third to last)	Displays error history. ("-" is displayed if no history is present.)	Code	
106	Abnormal thermistor display (TH3/TH6/TH7/TH8/TH32)	3 : TH3, TH32 6 : TH6 7 : TH7 8 : TH8 0 : No thermistor error	Sensor number	
107	Operation mode at time of error	Displayed in the same way as request code "0".	-	
108	Compressor-Operating current at time of error	0-50	A	
109	Compressor-Accumulated operating time at time of error	0-9999	10 hours	
110	Compressor-Number of operation times at time of error	0-9999	100 times	
111	Discharge temperature at time of error	3-217	°C	
112	Outdoor unit-Liquid pipe 1 temperature (TH3) at time of error	-40-90	°C	
113				
114	Outdoor unit-2-phase pipe temperature (TH6) at time of error	-39-88	°C	
115	Outdoor unit-Suction pipe temperature (TH32) at time of error	-39-88	°C	
116	Outdoor unit-Outside air temperature (TH7) at time of error	-39-88	°C	
117	Outdoor unit-Heatsink temperature (TH8) at time of error	-40-200	°C	
118	Discharge superheat (SHd) at time of error	0-255	°C	
119	Sub-cool (SC) at time of error	0-130	°C	
120	Compressor-Operating frequency at time of error	0-255	Hz	
121	Outdoor unit at time of error • Fan output step	0-10	Step	
122	Outdoor unit at time of error • Fan 1 speed (Only for air conditioners with DC fan)	0-9999	rpm	
123	Outdoor unit at time of error • Fan 2 speed (Only for air conditioners with DC fan)	0-9999	rpm	"0" is displayed if the air conditioner is a single-fan type.
124				
125	LEV (A) opening at time of error	0-500	Pulses	
126	LEV (B) opening at time of error	0-500	Pulses	
127	LEV (C) opening at time of error	0-500	Pulses	
128				
129	Condensing temperature (TH _{63HS}) at time of error			
130	Thermostat ON time until operation stops due to error	0-999	Minutes	

8-9-1. Detail Contents in Request Code

[Operation state] (Request code : " 0")

Data display

□ □ C 4

Relay output state
Operation mode

Operation mode

Display	Operation mode
0	STOP • FAN
C	COOL • DRY
H	HEAT
d	DEFROST

Relay output state

Display	Power currently supplied to compressor	Compressor	4-way valve	Solenoid valve
0	–	–	–	–
1				ON
2			ON	
3			ON	ON
4		ON		
5		ON		ON
6		ON	ON	
7		ON	ON	ON
8	ON			
A	ON		ON	

[Outdoor unit – Control state] (Request code : " 51")

Data display				State
0	0	0	0	Normal
0	0	0	1	Preparing for heat operation
0	0	0	2	Defrost

[Compressor – Frequency control state] (Request code : " 52")

Data display

0 0 * *

Frequency control state ②
Frequency control state ①

Frequency control state ①

Display	Current limit control
0	No current limit
1	Primary current limit control is ON.
2	Secondary current limit control is ON.

Frequency control state ②

Display	Discharge temperature overheat prevention	Condensation temperature overheat prevention	Anti-freeze protection control	Heat sink temperature overheat prevention
0				
1	Controlled			
2		Controlled		
3	Controlled	Controlled		
4			Controlled	
5	Controlled		Controlled	
6		Controlled	Controlled	
7	Controlled	Controlled	Controlled	
8				Controlled
9	Controlled			Controlled
A		Controlled		Controlled
b	Controlled	Controlled		Controlled
C			Controlled	Controlled
d	Controlled		Controlled	Controlled
E		Controlled	Controlled	Controlled
F	Controlled	Controlled	Controlled	Controlled

[Fan control state] (Request code : " 53")

Data display

0 0 * *

Fan step correction value by heat sink temperature overheat prevention control
Fan step correction value by cool condensation temperature overheat prevention control

Display	Correction value
– (minus)	–1
0	0
1	+1
2	+2

[Actuator output state] (Request code : "54")

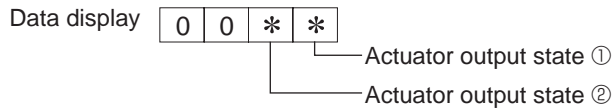

Actuator output state ①

Display	SV1	4-valve	Compressor	Compressor is warming up
0				
1	ON			
2		ON		
3	ON	ON		
4			ON	
5	ON		ON	
6		ON	ON	
7	ON	ON	ON	
8				ON
9	ON			ON
A		ON		ON
b	ON	ON		ON
C			ON	ON
d	ON		ON	ON
E		ON	ON	ON
F	ON	ON	ON	ON

Actuator output state ②

Display	52C	SV2	SS
0			
1	ON		
2		ON	
3	ON	ON	
4			ON
5	ON		ON
6		ON	ON
7	ON	ON	ON

[Error content (U9)] (Request code : "55")

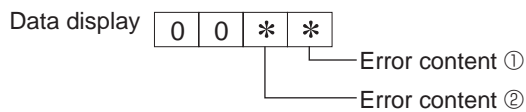

Error content ①

● : Detected

Display	Overtoltage error	Undervoltage error	L1-phase open error	Power synchronizing signal error
0				
1	●			
2		●		
3	●	●		
4			●	
5	●		●	
6		●	●	
7	●	●	●	
8				●
9	●			●
A		●		●
b	●	●		●
C			●	●
d	●		●	●
E		●	●	●
F	●	●	●	●

Error content ②

● : Detected

Display	Converter Fo error	PAM error
0		
1	●	
2		●
3	●	●

[Outdoor unit – Capacity setting display] (Request code : "70")

Data display	Capacity
9	35
10	50
11	60
14	71
20	100
25	125
28	140
40	200
50	250

[Outdoor unit – Setting information] (Request code : "71")

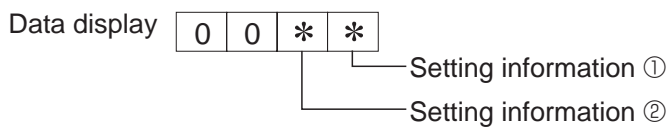

Setting information ①

Display	Defrost mode
0	Standard
1	For high humidity

Setting information ②

Display	Single-/ 3-phase	Heat pump/ cooling only
0	Single-phase	Heat pump
1		Cooling only
2	3-phase	Heat pump
3		Cooling only

→ : Indicates the visible parts in the photos/figures.

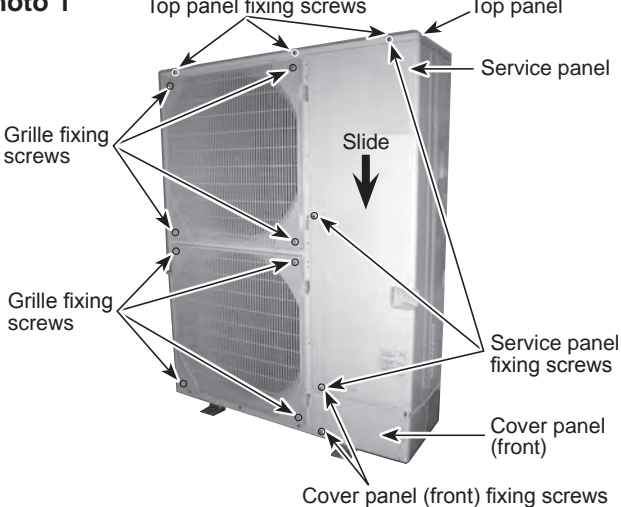
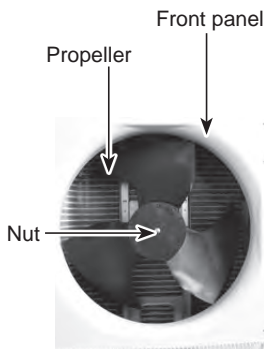
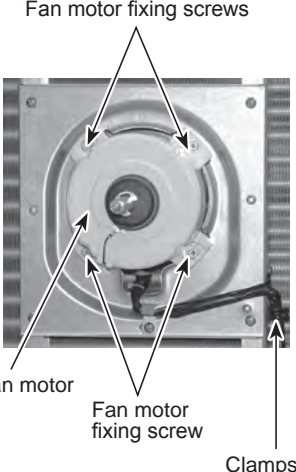
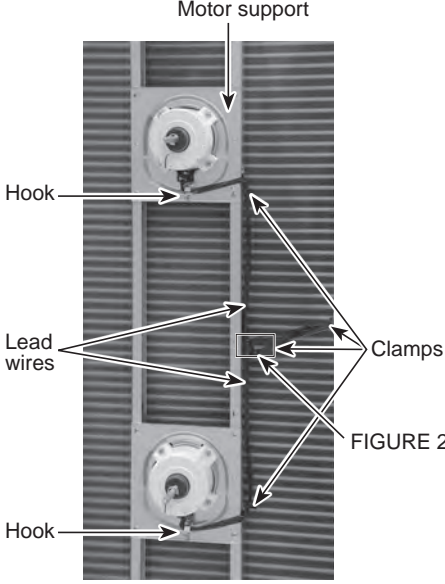
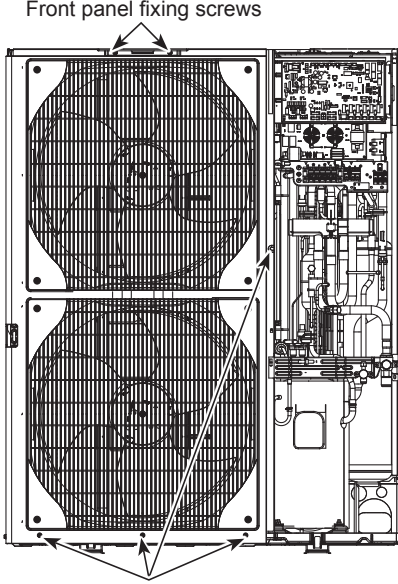
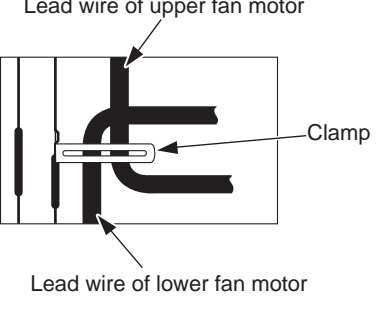
OPERATING PROCEDURE	PHOTOS/FIGURES	
<p>1. Removing the service panel and top panel</p> <ol style="list-style-type: none"> (1) Remove 3 service panel fixing screws (5 × 12) and slide the hook on the right downward to remove the service panel. (2) Remove screws (3 for front, 3 for rear/5 × 12) of the top panel and remove it. <p>Note: There is a screw fixing both the service panel and the top panel. Hence, the number of screws of either panel is one less than that mentioned above when both panels are removed.</p>	<p>Photo 1</p> 	
<p>2. Removing the fan motor (MF1, MF2)</p> <ol style="list-style-type: none"> (1) Remove the service panel. (See Photo 1) (2) Remove the top panel. (See Photo 1) (3) Remove cover panel (front) fixing screws (2 for front/5 × 12) to remove the cover panel (front). (See Photo 1) (4) Remove front panel fixing screws (2 for front/4 × 10, 5 for front/5 × 12) to remove the front panel and the grille together. (5) Remove the propeller. (See Photo 2-1) (Upper and lower) (6) Disconnect the connectors, CNF1 (white) and CNF2 (white), on the controller circuit board in the electrical parts box. (See Photo 3) (7) Release the lead wires from the clamps on the motor support and the separator. (8) Release the lead wires from the hole on the separator. (9) Remove fan motor fixing screws (4 for front/5 × 20) to detach the fan motor. (Upper and lower) (10) When installing the fan motor, fit the lead wire into the hook under the fan motor and fix it with clamps firmly. (11) When fixing with the clamps, route and fix the lead wires as indicated in the Figure 2. 	<p>Photo 2-1</p> 	<p>Photo2-2</p> 
<p>Photo 2-3</p> 	<p>Figure 1</p> 	<p>Figure 2</p> 

OPERATING PROCEDURE

PHOTOS/FIGURES

3. Removing the electrical parts box

- (1) Remove the service panel. (See Photo 1)
- (2) Remove the top panel. (See Photo 1)
- (3) Disconnect the indoor/outdoor connecting wires from terminal block.
- (4) Disconnect the connectors of CNF1, CNF2, LEV-A, LEV-B and LEV-C on the controller circuit board.
<Symbols on the board>
 - CNF1, CNF2 : Fan motor
 - LEV-A, LEV-B, LEV-C : LEV
 Release the lead wires of LEV from the clamps on top of the electrical parts box.
- (5) Disconnect the pipe-side connections of the following parts.
 - Thermistor <Liquid>(TH3)
 - Thermistor <Discharge>(TH4)
 - Thermistor <2-phase pipe>(TH6)
 - Thermistor <Ambient>(TH7)
 - Thermistor <Suction> (TH32)
 - Thermistor <Comp. surface> (TH34)
 - High pressure switch (63H)
 - Low pressure switch (63L)
 - High pressure sensor (63HS)
 - 4-way valve coil (21S4)
- (6) Remove the terminal cover and disconnect the compressor lead wire.
- (7) Remove the sensor holder from the rear guard on back of the unit.
- (8) Remove 2 electrical parts box fixing screws (4 × 10) and detach the electrical parts box by pulling it upward. The electrical parts box is fixed with 2 hooks on the left and 1 hook on the right.

Photo 3

< YKA2/YKA2R1 type >

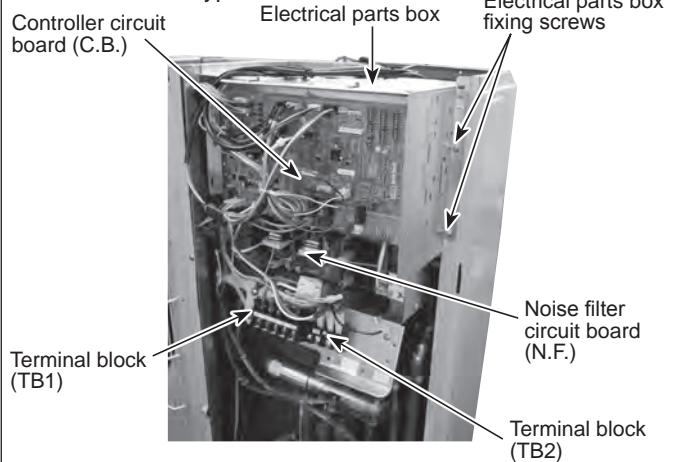

< YKA2R2 type >

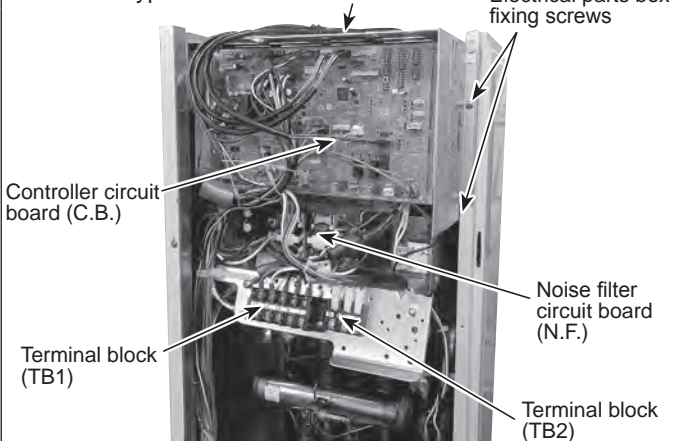

4. Removing the thermistor <2-phase pipe> (TH6)

- (1) Remove the service panel. (See Photo 1)
- (2) Remove the top panel. (See Photo 1)
- (3) Disconnect the connectors of TH6 and TH7 (red) on the controller circuit board in the electrical parts box.
- (4) Loosen the 2 wire clamps on top of the electrical parts box.
- (5) Pull out the thermistor <2-phase pipe> (TH6) from the sensor holder.

Note: In case of replacing thermistor <2-phase pipe> (TH6), replace it together with thermistor <Ambient> (TH7) since they are combined together. Refer to No.5 to remove thermistor <Ambient>.

Photo 4

< YKA2/YKA2R1 type >

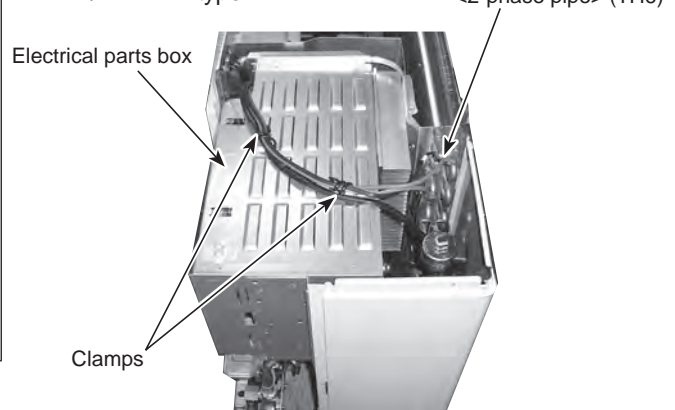

< YKA2R2 type >

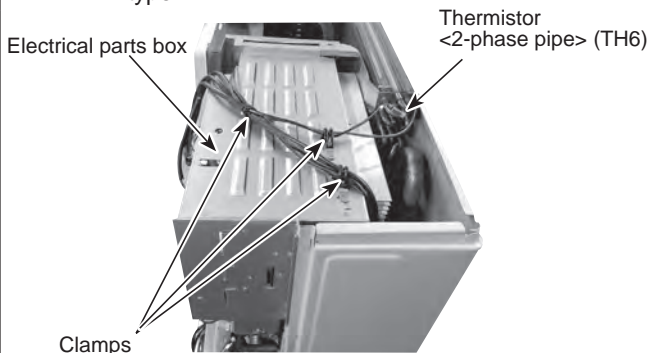

OPERATING PROCEDURE

5. Removing the thermistor <Ambient> (TH7)

- (1) Remove the service panel. (See Photo 1)
- (2) Remove the top panel. (See Photo 1)
- (3) Disconnect the connectors of TH6 and TH7 (red) on the controller circuit board in the electrical parts box.
- (4) Loosen the 2 wire clamps on top of the electrical parts box. (See Photo 4)
- (5) Pull out the thermistor <Ambient> (TH7) from the sensor holder.

Note: In case of replacing thermistor <Ambient> (TH7), replace it together with thermistor <2-phase pipe> (TH6), since they are combined together.
Refer to No.4 to remove thermistor <2-phase pipe>.

PHOTOS/FIGURES

Photo 5

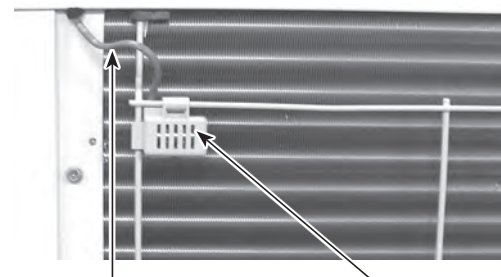

Lead wire of thermistor <Ambient> (TH7)

Sensor holder

6. Removing the thermistor <Liquid> (TH3), thermistor <Discharge> (TH4), thermistor <Suction> (TH32) and thermistor <Comp. surface> (TH34)

- (1) Remove the service panel. (See Photo 1)
- (2) Disconnect the connectors of TH3 (white), TH4 (white), TH32 (black) and TH34 (red) on the controller circuit board in the electrical parts box.
- (3) Release the lead wires from the cable strap on the electrical parts box.
Cut the cable tie bundling TH3, TH4 and TH34 to release the lead wires.
- (4) Loosen the clamp for the lead wire on separator.

[Removing the thermistor<Liquid pipe>(TH3)]

- (4) Pull out the thermistor <Liquid> (TH3) from the sensor holder.

[Removing the thermistor<Discharge>(TH4)]

- (4) Pull out the thermistor <Discharge> (TH4) from the sensor holder.

[Removing the thermistor<Suction pipe>(TH32)]

- (4) Pull out the thermistor <Suction> (TH32) from the thermoholder.
(TH32 : See Figure 5)

[Removing the thermistor<Comp. surface>(TH34)]

- (4) Remove the sound proof cover (upper) for compressor.
- (5) Pull out the thermistor <Comp. surface> (TH34) from the holder of the compressor shell.

Photo 6

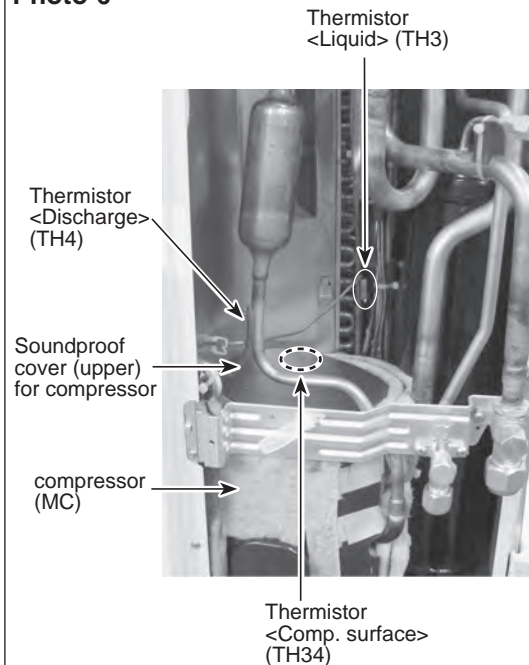

OPERATING PROCEDURE

7. Removing the 4-way valve coil (21S4) and linear expansion valve coil (LEV-A, LEV-B, LEV-C)

- (1) Remove the service panel. (See Photo 1)
- (2) Remove the top panel. (See Photo 1)

[Removing the 4-way valve coil]

- (3) Disconnect the connector of 21S4 on the controller circuit board in the electrical parts box.
Release the lead wire of the 4-way valve from the fastener and the cable strap in the electrical parts box.
- (4) Remove 4-way valve coil fixing screw (M4 × 6).
- (5) Remove the 4-way valve coil by sliding the coil toward you.

[Removing the linear expansion valve coil]

- (3) Remove the electrical parts box. (See Photo 3)
- (4) Remove 3 right side panel fixing screws (5 × 12) in the rear of the unit then remove the right side panel.
- (5) Cut the cable tie for fall-off prevention of LEV coils to release the lead wires.
- (6) Remove the linear expansion valve coil by sliding the coil upward.

8. Removing the 4-way valve

- (1) Remove the service panel. (See Photo 1)
- (2) Remove the top panel. (See Photo 1)
- (3) Remove the electrical parts box. (See Photo 3)
- (4) Remove 3 valve bed fixing screws (4 × 10), 4 ball valve and stop valve fixing screws (5 × 16) then remove the valve bed.
- (5) Remove cover panel (front) fixing screws (2 for front/5 × 12) to remove the cover panel (front).
- (6) Remove right side panel fixing screws (3 for heat exchanger/5 × 12) and 2 cover panel (rear) fixing screws (5 × 12) in the side and rear of the unit (both of them are fixed in the base) then remove the right side panel and the cover panel together. (See Figure 4)
- (7) Remove the 4-way valve coil.
- (8) Recover refrigerant.
- (9) Remove the welded part of 4-way valve.

9. Removing the linear expansion valve

- (1) Remove the service panel. (See Photo 1)
- (2) Remove the top panel. (See Photo 1)
- (3) Remove 3 valve bed fixing screws (4 × 10), 4 ball valve and stop valve fixing screws (5 × 16) then remove the valve bed.
- (4) Remove cover panel (front) fixing screws (2 for front/5 × 12) to remove the cover panel (front).
- (5) Remove right side panel fixing screws (3 for heat exchanger/5 × 12) and 2 cover panel (rear) fixing screws (5 × 12) in the side and rear of the unit (both of them are fixed in the base) then remove the right side panel and the cover panel together. (See Figure 4)
- (6) Remove the linear expansion valve coil.
- (7) Recover refrigerant.
- (8) Remove the welded part of linear expansion valve.

PHOTOS/FIGURES

Figure 3

< YKA2/YKA2R1 type >

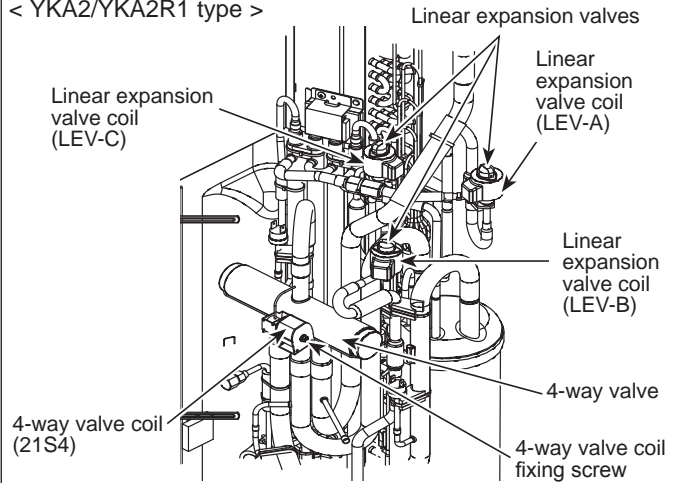

< YKA2R2 type >

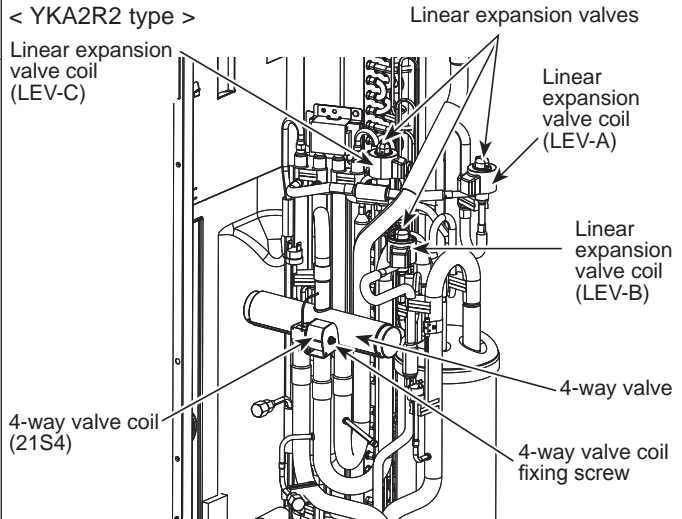

Note 1: Recover refrigerant without spreading it in the air.
Note 2: The welded part can be removed easily by removing the right side panel.

Note 3: When installing the parts of refrigerant circuit, cover it with a wet cloth to prevent it from heating (120°C or more), then braze the pipes so that the inside of pipes are not oxidized.

Figure 4

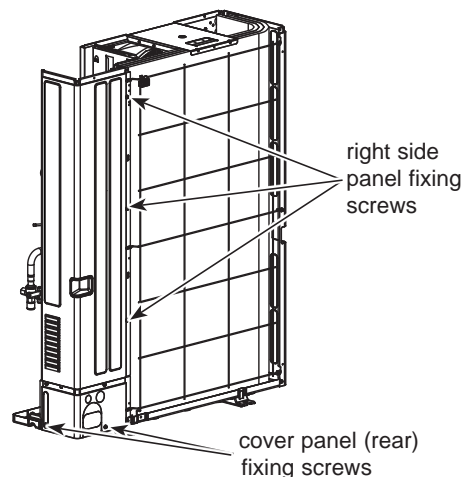

OPERATING PROCEDURE

10. Removing the high pressure switch (63H) and low pressure switch (63L)

- (1) Remove the service panel. (See Photo 1)
- (2) Remove the top panel. (See Photo 1)
- (3) Remove the electrical parts box. (See Photo 3)
- (4) Remove the valve bed. (See Photo 9)
- (5) Remove cover panel (front) fixing screws (2 for front/5 × 12) to remove the cover panel (front).
- (6) Remove right side panel fixing screws (3 for heat exchanger/5 × 12) and 2 cover panel (rear) fixing screws (5 × 12) in the side and rear of the unit (both of them are fixed in the base) then remove the right side panel and the cover panel together. (See Figure 4)
- (7) Disconnect the lead wire of high pressure switch and low pressure switch.
- (8) Recover refrigerant.
- (9) Remove the welded part of high pressure switch and low pressure switch.

Note 1: Recover refrigerant without spreading it in the air.

Note 2: The welded part can be removed easily by removing the side panel (R).

Note 3: When installing the parts of refrigerant circuit, cover it with a wet cloth to prevent it from heating (100°C or more), then braze the pipes so that the inside of pipes are not oxidized.

< YKA2R2 type >

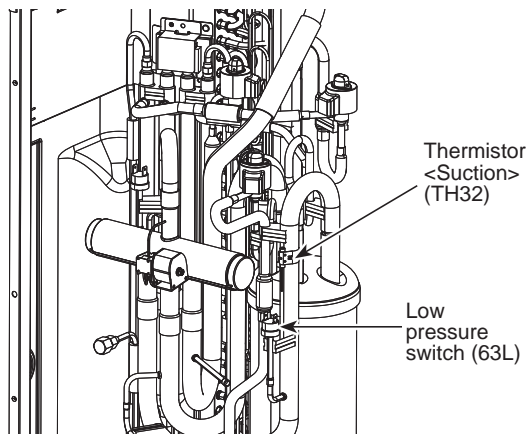

PHOTOS/FIGURES

Photo 7

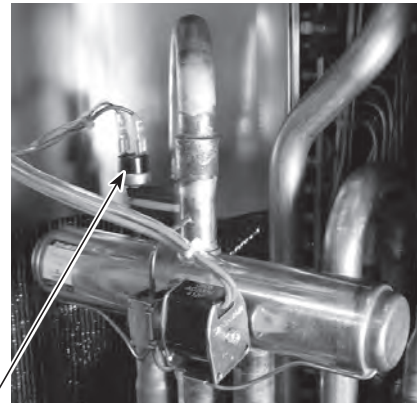

High pressure switch

Figure 5

< YKA2/YKA2R1 type >

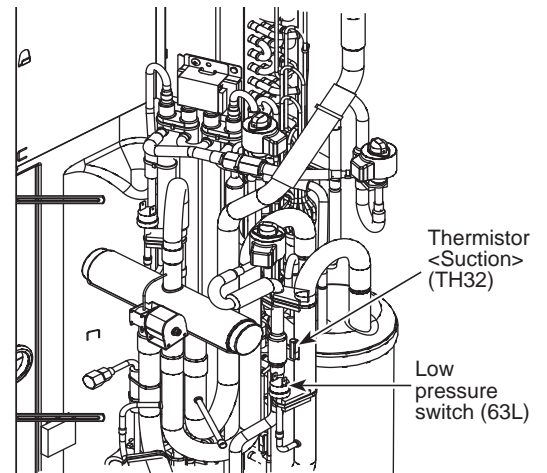

11. Removing the compressor (MC)

- (1) Remove the service panel. (See Photo 1)
- (2) Remove the top panel. (See Photo 1)
- (3) Remove 2 front cover panel fixing screws (5 × 12) and remove the front cover panel.
- (4) Remove 4 back cover panel fixing screws (5 × 12) and remove the back cover panel.
- (5) Remove the electrical parts box. (See Photo 3)
- (6) Remove 3 valve bed fixing screws (4 × 10), 4 ball valve and stop valve fixing screws (5 × 16), then remove the valve bed.
- (7) Remove 3 right side panel fixing screws (5 × 12) in the rear of the unit and remove the right side panel.
- (8) Remove front panel fixing screws (2 for front/4 × 10, 5 for front/5 × 12) to remove the front panel.
- (9) Remove the soundproof cover for compressor.
- (10) Remove the terminal cover and remove the compressor lead wire.
- (11) Recover refrigerant.
- (12) Remove the welded pipe of compressor inlet, outlet and injection pipe.
- (13) Remove the 3 points of the compressor fixing nut using a spanner or an adjustable wrench.
- (14) Remove the compressor.

Note: Recover refrigerant without spreading it in the air.

Photo 8

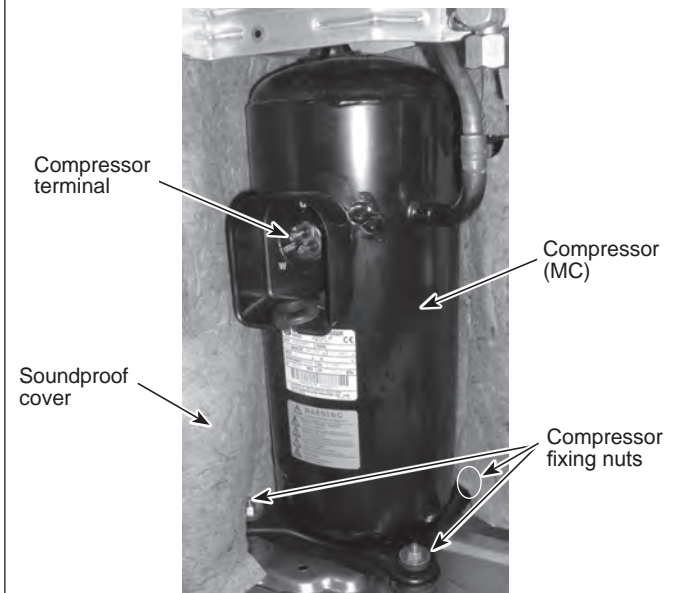

OPERATING PROCEDURE

12. Removing the power receiver

- (1) Remove the service panel. (See Photo 1)
- (2) Remove the top panel. (See Photo 1)
- (3) Remove 2 front cover panel fixing screws (5 × 12) and remove the front cover panel.
- (4) Remove 4 back cover panel fixing screws (5 × 12) and remove the back cover panel.
- (5) Remove the electrical parts box. (See Photo 3)
- (6) Remove 3 valve bed fixing screws (4 × 10) and 4 ball valve and stop valve fixing screws (5 × 16) and then remove the valve bed.
- (7) Remove 3 right side panel fixing screws (5 × 12) in the rear of the unit and then remove the right side panel.
- (8) Recover refrigerant.
- (9) Remove 4 welded pipes of power receiver inlet and outlet.
- (10) Remove 2 receiver leg fixing screws (4 × 10).

Note: Recover refrigerant without spreading it in the air.

PHOTOS/FIGURES

Photo 9

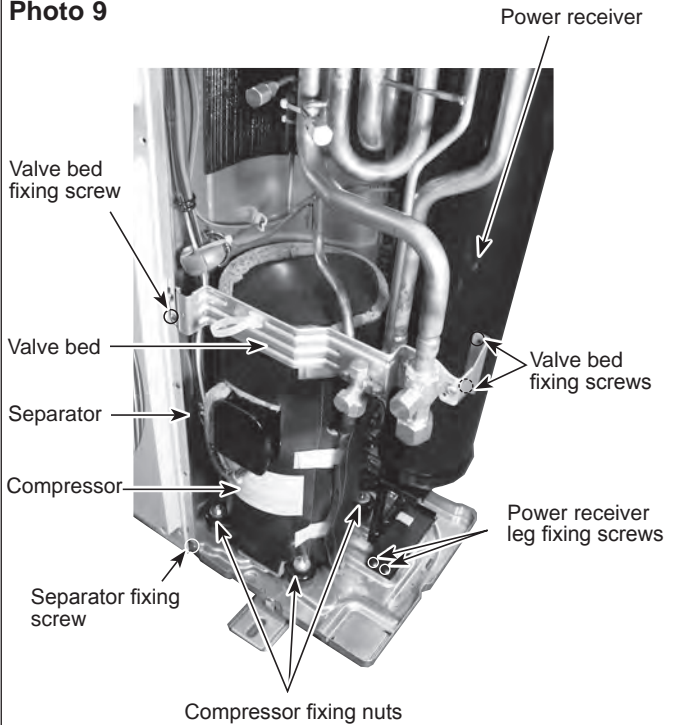
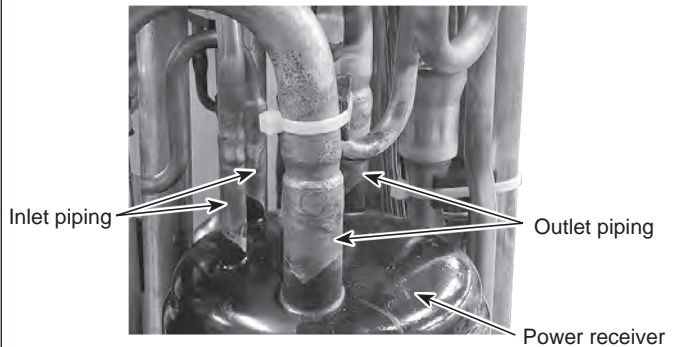

Photo 10



13. Removing the high pressure sensor (63HS)

- (1) Remove the service panel. (See Photo 1)
- (2) Remove the top panel. (See Photo 1)
- (3) Pull out the lead wire of high pressure sensor.
- (4) Remove the band that is fixing the rubber mount and the sensor.
- (5) Recover refrigerant.
- (6) Remove the welded part of high pressure sensor.

Note 1: Recover refrigerant without spreading it in the air.

Note 2: The welded part can be removed easily by removing the right side panel.

Note 3: When installing the high pressure sensor, make sure to cover it with a wet cloth to prevent it from heating (100°C or more), then braze the pipes so that the inside of pipes are not oxidized.

Figure 6

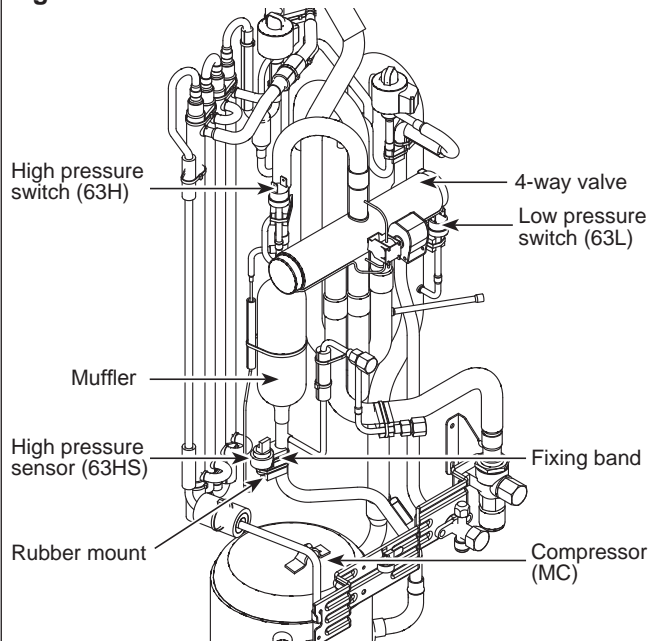

MITSUBISHI ELECTRIC CORPORATION

HEAD OFFICE : TOKYO BUILDING, 2-7-3, MARUNOUCHI, CHIYODA-KU, TOKYO 100-8310, JAPAN

©Copyright 2015 MITSUBISHI ELECTRIC CORPORATION
Issued: Dec. 2018 No. OCH594 REVISED EDITION-B
Issued: Oct. 2017 No. OCH594 REVISED EDITION-A
Published: Jul. 2015 No. OCH594
Made in Japan

Specifications are subject to change without notice.