



Easy KIT®



Cuprins

Tubulatură pentru canalizări interioare Pipes for interior sewage /	213
Fitinguri pentru canalizări interioare Fittings for interior sewage /	213
Sifoane Traps /	217
Tubulatură pentru canalizări interioare PP alb White pipes for interior sewage /	221
Accesorii Accessories / A a	222
Scheme tip pentru canalizare interioara Scheme for interior sewage /	223

Tubulatură pentru canalizări interioare

Pipes for interior sewage /

Tub PP cu 1 muf

PP single socket pipe

D (mm)	L (mm)	Cod code/		
32	250	11032025000	75	4050
	500	11032050000	75	2025
	750	11032075000	75	1350
	1000	11032100000	75	1350
	1500	11032150000		75
	2000	11032200000		100
40	250	11040025000	45	2430
	500	11040050000	45	1215
	750	11040075000	45	810
	1000	11040100000	45	810
	1500	11040150000	45	
	2000	11040200000		30
50	250	11050025000	30	1620
	500	11050050000	30	810
	750	11050075000	30	540
	1000	11050100000	30	540
	1500	11050150000		30
	2000	11050200000		30
	3000	11050300000		30

D (mm)	L (mm)	Cod code/		
75	250	11075025000	14	756
	500	11075050000	14	378
	1000	11075100000	14	252
	1500	11075150000		14
	2000	11075200000		30
	3000	11075300000		30
110	250	11110025000	18	324
	500	11110050000	18	162
	750	11110075000	18	108
	1000	11110100000	18	108
	1500	11110150000		18
	2000	11110200000		15
125	250	11125025000	15	270
	500	11125050000	15	135
	1000	11125100000	15	90
	1500	11125150000		15
	2000	11125200000		10
	3000	11125300000		10
160	500	11160050000	10	
	1000	11160100000	10	
	1500	11160150000	10	
	2000	11160200000	10	
	3000	11160300000	10	



Garnitur pentru tub PP

Rubber seal for PP pipe

D (mm)	Cod code/
32	15391032000*
40	15391040000*
50	15391050000*
75	15391075000*
110	15391110000*
125	15391125000*
160	15391160000*



Fitinguri pentru canalizări interioare

Fittings for interior sewage /

Cot PP

PP bend / PP

D (mm)	a	Cod /code		
32	15°	15040103215	80	
	30°	15040303230	80	
	45°	15040603245	85	9520
	67°30'	15040803267	85	9520
	87°30'	15041203287	70	7840
40	15°	15041304015	50	
	30°	15041504030	50	
	45°	15041804045	100	5400
	67°30'	15042004067	115	6210
	87°30'	15042404087	90	4860
50	15°	15042505015	30	
	30°	15042705030	30	
	45°	15043005045	65	3510
	67°30'	15043205067	60	3240
	87°30'	15043605087	60	3240

D (mm)	a	Cod /code		
75	15°	15044107515		
	30°	15044107530		
	45°	15044107545	20	
	67°30'	15044307567	20	
	87°30'	15044707587	20	
110	15°	15044911015	20	
	30°	15045111030	20	
	45°	15045411045	45	540
	67°30'	15045611067	40	480
	87°30'	15046011087	40	480
125	45°	15046512545	15	
	67°30'	15046712567	15	
	87°30'	15047112587	10	
160	45°	15047716045	10	
	87°30'	15048316087	10	



Cutie cot PP cu garnitur nemontat

PP bend box whit rubber seal unmounted /

D (mm)	a	Cod /code	
32	45°	15040613245*	700
	67°30'	15040813267*	800
	87°30'	15041213287*	700
40	45°	15041814045*	450
	67°30'	15042014067*	450
	87°30'	15042414087*	400
50	45°	15043105045*	1500
	67°30'	15043305067*	1400
	87°30'	15043705087*	1400
110	45°	15045511045*	250
	67°30'	15045711067*	230
	87°30'	15046111087*	200



*pe baza de comanda / upon firm request /
- numar bucati ambalate / number of the packed items /



Sistem de canalizare interioară

Interior sewage system
Система внутренней канализации

Curb tehnic cu garnitur pentru racordare obiecte sanitare - PP
PP - spigot bend with washer

Tip	D (mm)	D ₁ (mm)	D ₂ (mm)	L (mm)	Cod code/	
curb	32	46	24/32	74	15180303232	40
straight coupling/40	46	46	24/32	74	15180704032	40
	40	46	36/40	74	15180904040	40
conector	40	46	24/32	88	15630004032	40
straight bend/	40	46	36/40	88	15630004040	40

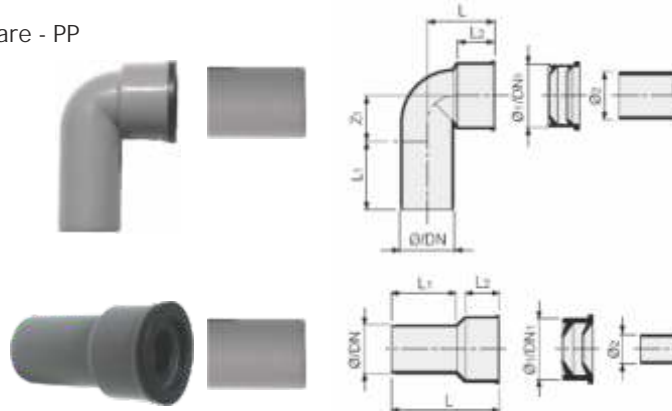

Conector redus
Connector reducer

D (mm)	Cod /code		
40/32	15130104032	120	13440
50/40	15130205040	60	6720



Cutie conector redus cu garnitur nemontat
Connector reducer box whit rubber seal unmounted

D (mm)	Cod /code	
40/32	15130114032*	1100
50/42	15130215040*	600



Cot alb WC cu garnitur și dop - HTSB
HTSB white bend WC with washer and plug

D (mm)	H (mm)	a	Cod code/	
110	230	45°	15340311045	15
110	280	90°	15340111090	

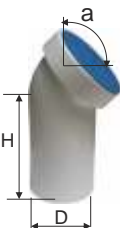

Cot alb WC prelungit cu garnitur și dop
Extension WC white bend, with seal and plug

D (mm)	H (mm)	L (mm)	a	Cod code/	
110	230	180	90°	15430111090	10

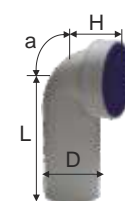

Ramifica ie egal - PP
PP branch

D (mm)	H (mm)	a	Cod code/		
32	128	45°	15080203245	40	4480
	137	67°30'	15080303267	40	
	120	87°30'	15080603287	40	4480
40	170	45°	15080804045	50	2700
	171	67°30'	15080904067	20	
	171	87°30'	15081204087	60	3240
50	180	45°	15081405045	50	1800
	164	67°30'	15081605067	50	1800
	161	87°30'	15081805087	55	1980
75	220	45°	15081907545	20	
	198	67°30'	15082107567	20	
	197	87°30'	15082307587	20	
110	286	45°	15082611045	20	240
	243	67°30'	15082811067	20	240
	234	87°30'	15083011087	25	300
125	318	45°	15083112545		
	332	67°30'	15083312567	10	
	271	87°30'	15083512587		
160	410	45°	15083716045		
	421	67°30'	15083916067		
	419	87°30'	15084116087		



Cutie ramifica ie PP garnitur nemontat
PP branch box whit rubber seal unmounted

D (mm)	a	Cod /code	
32/32	45°	15080213245*	400
	87°30'	15080613287*	450
40/40	45°	15080904045*	1150
	87°30'	15081214087*	1300
50/50	45°	15081415045*	700
	67°30'	15081615067*	700
	87°30'	15081815087*	800
110/110	45°	15082711045*	100
	67°30'	15082911067*	100
	87°30'	15083111087*	120



*pe baza de comanda / upon firm request /
- numar bucati ambalate / number of the packed items /

Ramifica ie redus - PP

PP reduced branch

D ₁ (mm)	D ₂ (mm)	H (mm)	a	Cod code/ code/		
40	32	146	45°	15100104045	40	
		140	67°30'	15100304067	40	
		132	87°30'	15100504087	40	
50	40	152	45°	15100805045	40	1620
		151	67°30'	15100905067	25	
		152	87°30'	15101105087	25	
75	40	181	45°	15101307545	25	
		155	67°30'	15101507567*	25	
		154	87°30'	15101707587	25	
	50	185	45°	15101907545	25	
		172	67°30'	15102107567	25	
110	40	170	87°30'	15102307587	25	
		202	45°	15102511045	20	
		195	67°30'	15102711067	20	
		175	87°30'	15102911087	20	

D ₁ (mm)	D ₂ (mm)	H (mm)	a	Cod code/ code/		
110	50	179	45°	15103211045	35	420
		174	67°30'	15103411067	40	480
		184	87°30'	15103611087	40	480
75	50	238	45°	15103711045	15	
		223	67°30'	15103911067	15	
		211	87°30'	15104111087	20	
		251	45°	15104312545	10	
125	50	225	67°30'	15104512567*	10	
		223	87°30'	15104712587*	10	
		317	45°	15104912545	8	
		280	67°30'	15105112567	8	
160	110	272	87°30'	15105312587	10	
		341	45°	15106116045		
		313	67°30'	15106316067*	5	
125	110	305	87°30'	15106516087		
		371	45°	15106716045	5	
		369	87°30'	15107116087	5	



Ramifica ie dubl - PP

PP double branch

D ₁ (mm)	D ₂ (mm)	H (mm)	a	Cod code/ code/	
50	50	172	67°30'	15060105067	20
75	75	206	67°30'	15060507567	10
110	50	189	67°30'	15060911067	10
110	50	184	87°30'	15061111087	10
110	110	254	67°30'	15061311067	5
110	110	254	87°30'	15061511087	5

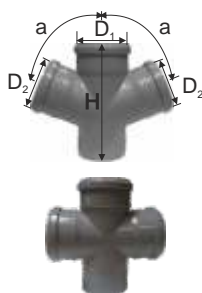

Cutie ramifica ie redus PP cu garnitur nemontat

PP reduced branch box whit rubber seal unmounted

D (mm)	a	Cod /code	
50/40	45°	15100815045*	900
110/50	45°	15103311045*	200
	67°30'	15103511067*	200
	87°30'	15103711087*	200



Man on - PP

PP slip coupling

D (mm)	L (mm)	Cod code/ code/		
32	78	15260103200	100	11200
40	89	15260204000	50	5600
50	92	15260405000	30	3360
75	120	15260507500	20	
110	115	15260811000	25	900
125	147	15260912500	20	
160	204	15261116000	10	



Cutie man on EasyKIT PP cu garnitur nemontat

PP slip coupling box whit rubber seal unmounted

D (mm)	Cod /code	
32	15260113200*	900
42	15260214000*	450
50	15260415000*	330
110	15260911000*	340



Reduc ie excentric - PP

PP eccentric reducer

Tip type	D (mm)	D ₁ (mm)	H (mm)	Cod code/ code/		
a	40	32	98	15140114032	70	7840
a	50	32	98	15140215032	50	5600
a	50	40	125	15140315040	90	4860
b	75	40	75	15140507540	30	
b	75	50	75	15140707550	30	
b	110	50	74	15141011050	40	2160
b	110	75	82	15141111075	20	
b	125	75	85	15141312575	20	
b	125	110	86	15141512511	30	
a	160	110	173	15141716011	20	
a	160	125	160	15141916012		

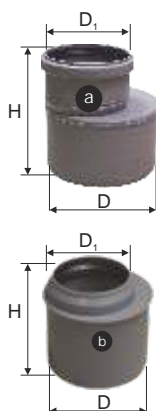

Cutie reduc ie excentric PP cu garnitur nemontat

PP eccentric reducer box whit rubber seal unmounted

D (mm)	Cod /code	
40/32	15140124032*	650
50/32	15140225032*	500
50/40	15140325040*	400
110/50	15141111050*	800



*pe baza de comanda / upon firm request /
- numar bucati ambalate / number of the packed items /



Sistem de canalizare interior

Interior sewage system
Система внутренней канализации

Adaptor excentric Eccentric reducer

D/D ₁ (mm)	H (mm)	Cod code/ code/		
32/40	95	17003413240	70	7840
40/50	99	17003304050	30	
50/75	101	17003905075	20	



Cutie adaptor excentric cu garnitur nemontat Eccentric reducer box whit rubber seal unmounted

D (mm)	Cod /code	
32/40	17003423240*	650



Conector dilata ie Extension socket

D (mm)	L (mm)	Cod code/ code/	
110	170	15300711000	20



Conector PP de trecere la font cu inel i garnitur dubl PP adaptor for cast iron pipes with o-ring and washer

D (mm)	D ₁ (mm)	L (mm)	Cod code/ code/	
50	72	151	15690105000	20
75	92	148	15690307500	20
110	124	160	15690511000	20
125	151	184	15690712500	10



Pies cap t pentru coloan ventilare Connector for vent

D (mm)	Cod code/ code/
50	13940105000
75	13940307500
110	13940511000
160	13940516000



Dop de închidere - PP PP plug

D (mm)	L (mm)	Cod code/ code/	
32	32	15240103200	
40	32	15240104000	40
50	32	15160805005	
75	32	15240507500	15
110	42	15240711000	20
125	51	15240912500	10
160	57	15241116000	

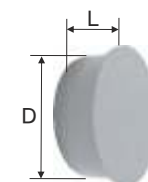

Pies cur ire cu dop filetat - PP PP access pipe with cap

D (mm)	H (mm)	Cod code/ code/		
50	194	15160405000	20	1080
75	195	15160507500	20	
110	247	15160811000	30	360
125	257	15160912500	10	
160	298	15161116000	5	



Cutie pies cur ire PP cu garnitur nemontat PP access pipe with cap box whit rubber seal unmounted

D (mm)	Cod /code	
50	15160315000*	800
110	15160911000*	120



Dop pentru pies cur ire Cap for PP access pipe

D (mm)	Cod code/ code/
50	15160805005
110	15160811005



Sifoane

Traps /

Sifon pardoseal cu ie ire orizontal , DN 40/50, gard ap 30mm, în l ime reglabil Floor trap DN 40/50 horizontal with flange, siphon height 30mm, cut-to-size grate frame 12-70mm

DN	Debit capacity (l/s)	Mas Weight (Kg)	Cod code
40/50	0,43	0,7	17140405030

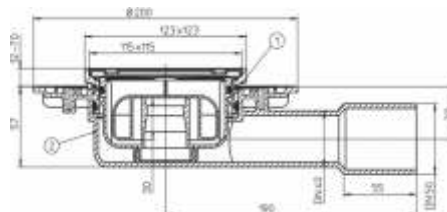

Material: PE

În l ime de montaj / Installation height: 57 mm

Clas de înc rcare / load class: 300 kg

Pies de reglare 12-70 mm / 123x123 mm i gr tar inox 115x115 mm / extension 12-70mm / 123x123mm and stainless steel grate 115x115mm



*pe baza de comanda / upon firm request /
- numar bucati ambalate / number of the packed items /

Sifon pardoseal cu ie ire vertical , DN 50/75/110 în l ime reglabil , gr tar inox
Floor drain DN 50/75/110 vertical with flange, cut-to-size grate frame 12-70 mm

DN	Debit capacity (l/s)	Mas Weight (Kg)	Cod code
50/75/110	0,67	0,7	17140501101

Material : PE
Inaltime de montaj/ Installation height : 158 mm
Clasa de incarcare/load class : 300 kg
Piesa de reglare 12-70 mm/123 x 123 mm si gratar inox 115 x 115 mm /
extension 12-70mm / 123x123mm and stainless steel grate 115x115mm



Sifon pardoseal cu ie ire vertical , DN 50/75/110 în l ime reglabil , gr tar font A15
Floor drain DN 50/75/110 vertical with flange, trap seal, cut-to-size plastic extension 34-70 mm, cast iron grate frame class 15

DN	Debit capacity (l/s)	Mas Weight (Kg)	Cod code
50/75/110	0,67	2,4	17140501115*

Material : PE
Inaltime de montaj/ Installation height : 158 mm
Clasa de incarcare/load class : 1,5 t
Piesa de reglare 34-70 mm/150 x 150 mm si gratar fonta 137 x 137 mm /
extension 34-70 mm / 150 x 150 mm and cast iron grate 137 x 137 mm



Aerator PP cu membran
Aerator admittance valve

D (mm)	Cod code/
32/40/50	17040003250
50/75/110	17040005011

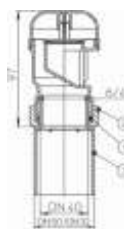

Sifon pardoseal cu 4 intr ri - 1 ie ire
Trap 1 outlet, 4 inlets

D ₁	D ₂	Ø	H	Cod
intrare (mm)	evacuare (mm)	(mm)	(mm)	code/
4x40	50	120	105	17101101200
4x40	50	120	150	17101501200

Sifon cu 4 piuli e, 4 garnituri, 2 dopuri
Trap with 4 ring nuts, 4 conic seals and 2 blind plugs



Dop pentru sifon pardoseal
Blind plug

D (mm)	Cod code/
40	17102304000



Sifon pardoseal vizitabil cu 4 intr ri - 1 ie ire
Trap complete with 4 ring nuts, 4 conic seals, 2 blind plugs, 1 outlet, 4 inlets d.40

D ₁	D ₂	Ø	H	Cod
intrare (mm)	evacuare (mm)	(mm)	(mm)	code/
4x40	50	120	120	17105001200
4x40	75	120	120	17107501200*

Sifon cu 4 piuli e, 4 garnituri, 2 dopuri
Trap with 4 ring nuts, 4 conic seals and 2 blind plugs

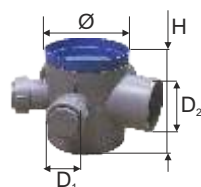

Garnitur conic pentru sifon pardoseal
Conic sea

D (mm)	Cod code/
40	17102504000*



Sifon pardoseal vizitabil cu 3 intr ri - 1 ie ire
Trap complete with 3 ring nuts, 3 conic seals, 2 blind plugs, 1 outlet, 3 inlets d.40

D ₁	D ₂	Ø	H	Cod
(mm)	(mm)	(mm)	(mm)	code/
40	50	120	63	17101100832
40	50	120	80	17101101831 12 432

Sifon cu 3 piuli e, 3 garnituri, 2 dopuri
Trap with 3 ring nuts, 3 conic seals and 2 blind plugs

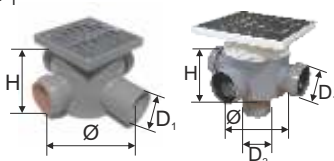

Piuli olandez pentru sifon pardoseal
Threaded ring nut

D (mm)	Cod code/
40	17102104000*

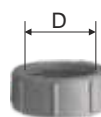

*pe baza de comanda / upon firm request /
- numar bucati ambalate / number of the packed items /



Sistem de canalizare interioar

Interior sewage system
Система внутренней канализации

Gr tar p trat inox pentru sifon pardoseal
Inox grid plate

L (mm)	H (mm)	Cod code/
140	22	17120501400



Gr tar circular inox pentru sifon
Inox grid plate

D (mm)	Ø (mm)	Cod code/
125	100	17002912510

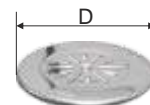

Minisifon pardoseal cu ie ire horizontal
HDPE minifloor trap with horizontal outlet

D (mm)	H (mm)	L (mm)	Cod code/
32	55	100	17012203200



Gr tar circular inox cu dispozitiv antisfum
Gridded plug with antifoam valve

D (mm)	H (mm)	D ₁ (mm)	Cod code/
120	75	140	17120101200



Minisifon pardoseal cu ie ire orientabil
HDPE mini floor drain, outlet, winding outlet with extension, 100x100 grid and leaf screen

D (mm)	H (mm)	Ø (mm)	Cod code/
40/50	100	250	17012205000

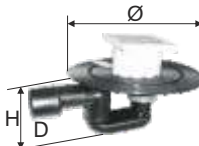

Sifon PEHD
HDPE trap

D ₁ (mm)	D ₂ (mm)	H (mm)	Cod code/
1x40	1x50	125	17002005040
3x40	1x50	125	17002105040*



Sifon PP teras gr tar cu ie ire
PP terrace trap with grid, "reduced encumbrance" version outlet

L (mm)	D (mm)	H (mm)	Cod code/
100x100	40	85	17038004000



Sifon încadrat pentru ma ina de sp lat
Built-in HDPE washing machine drain pipe

D (mm)	H (mm)	L (mm)	Cod code/
40/50	235	110	17003505000

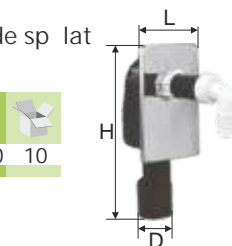

Curb PEHD cu olandez alam
HDPE elbow with brass nut

D ₁ (mm)	D ₂ (mm)	Cod code/
40	1" 1/4	17018004040
40	1" 1/2	17019004050



Ventil de scurgere cu preaplin
Overflow with drain

D (mm)	H (mm)	Cod code/
1" 1/2	140-200	17021505000



Ventil scurgere cu dop i lan
Skin drain with chain

D ₁ (mm)	D ₂ (mm)	Cod code/
85	1" 1/4	17021904000
85	1" 1/2	17022105000



Coloan scurgere cad cu dop i lan
Universal waste pipe for bathtub with plug and chain

D (mm)	H (mm)	L (mm)	Cod code/
1" 1/2	460-560	110-230	17012404050



Sifon cad erpuit orientabil
HDPE bath trap

D (mm)	D ₁ (mm)	H (mm)	L (mm)	Cod code/
1" 1/2	40/50	90	210	17014305000



Tub alb PP flexibil/gofrat
Trap hose pipe with seal and fitting

D ₁ (mm)	D ₂ (mm)	Cod code/
32	1" 1/4	17007703240
40	1" 1/2	17007804050

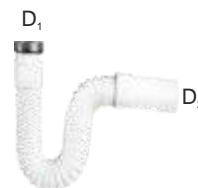

*pe baza de comanda / upon firm request /
- numar bucati ambalate / number of the packed items /

Sifon PP terasă ieşire orizontală
PP floor drain with horizontal outlet
PP

D (mm)	H (mm)	L (mm)	Cod code/
50	75	150	17030305075



Sifon baie ABS cromat cu ieşire verticală
Chromium plated floor drain (ABS) with vertical outlet
ABS

H1 (mm)	H (mm)	D (mm)	L (mm)	Cod code/
95	60	50	100	17060100050
95	60	50	150	17060150050

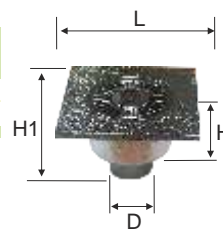

Sifon PP terasă ieşire orizontală
PP floor drain with horizontal outlet
PP

L (mm)	D (mm)	H (mm)	Cod code/
100x100	50	80	17039005000

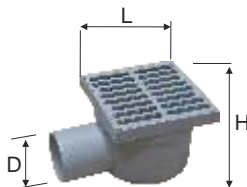

Gr tar p trat inox
Stainless steel grill plate

L (mm)	Cod code/
100	17121100100
150	17121150150

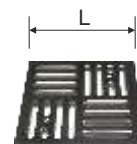

Sifon PP, cu gr tar , înălţime reglabilă
PP floor drain, with grill, height-adjustable
PP

L (mm)	min (mm)	H max (mm)	D (mm)	Cod code/
150	150	257	75	17050150075
150	150	257	110	17050150110

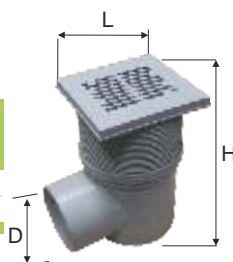

Sifon plat du cu racord PEHD
Low type shower trap hdpe fitting with screw grid

D ₁ (mm)	D ₂ (mm)	H (mm)	L (mm)	Cod code/
50/40	80	120	210	17004905080

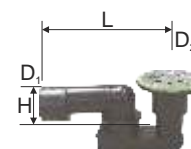

Clapetă dublă pentru sifoane
montare demisol cu ieşire D.110
Double flap valve D.110

D1 (mm)	D2 (mm)	Cod code/
70	103	17102110110



Sifon alb PP tip "butelie" lavoar
Bottle trap-white PP

D ₁ (mm)	D ₂ (mm)	H (mm)	L (mm)	Cod code/
32	1" 1/4	225	245	17022303240
40	1" 1/2	225	245	17022504050

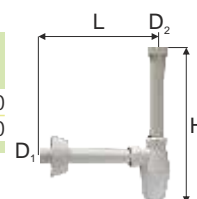

Sifon WC turcesc
Floor level WC pan trap

D (mm)	L (mm)	H (mm)	a	Cod code/	5
110	280	207	45°	15330111104	5
110	340	210	90°	15330011100	5



Sifon "Firenze"
Trap "Firenze"
"Firenze"

D (mm)	L (mm)	H (mm)	H ₁ (mm)	Cod code/
110	500	151	260	15331101000



Sifon cad erpuit plat
HDPE bath trap

D (mm)	D ₁ (mm)	H (mm)	L (mm)	Cod code/
1"1/2	40/50	90	210	17014405050



Prelungire sifon
Trap extension

Cod code/
17001900001



Sifon alb PP pentru sp lator dublu cu racord la ma ina de sp lator
Double sink trap with washing machine connection - white PP

D (mm)	D ₁ (mm)	H (mm)	L ₁ (mm)	L ₂ (mm)	Cod code/
1"1/2	40	250	310	290	17021004050*

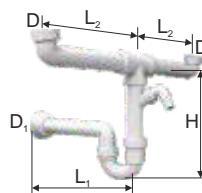

*pe baza de comanda / upon firm request /
- numar bucati ambalate / number of the packed items /



Sistem de canalizare interioară

Interior sewage system
Система внутренней канализации

Easy

Tubulatură pentru canalizări interioare PP alb

Pipes for interior sewage PP white/

Tub PP cu 1 muf alb

PP white single socket pipe

D (mm)	L (mm)	Cod code/		
32	250	11032025002	75	4050
	500	11032050002	75	2025
	750	11032075002	75	1350
	1000	11032100002	75	1350
40	250	11040025002	45	2430
	500	11040050002	45	1215
	750	11040075002	45	810
50	1000	11040100002	45	810
	250	11050025002	30	1620
	500	11050050002	30	810
110	750	11050075002	30	540
	1000	11050100002	30	540
	250	11110025002	18	324
500	500	11110050002	18	162
	750	11110075002	18	108
	1000	11110100002	18	108



Conector redus PP alb

PP white connector reducer

D/D1 (mm)	Cod code/		
40/32	15130124032	120	13440
50/40	15130225040	60	6720



Reduc ie excentric PP alb

PP white eccentric reducer

D/D1 (mm)	Cod code/		
40/32	15140134032	70	7840
50/32	15140235032	50	5600
50/40	15140335040	90	4860
110/50	15141021050	40	2160



Man on PP alb

PP white slip coupling

D (mm)	Cod code/		
32	15260123200	100	11200
40	15260224000	50	5600
50	15260425000	30	3360
110	15260821000	25	900



Adaptor reductie excentric

Eccentric reducer

D/D1 (mm)	Cod code/
32/40	17003433240

Dop pentru pies cur ire PP alb

PP white plug

D (mm)	Cod code/
50	15160825005*



Cot PP alb

PP white plug

D (mm)	Cod code/		
32	45°	15040623245	85 9520
	87°	15041223287	70 7840
40	45°	15041824045	100 5400
	87°	15042424087	90 4860
50	45°	15043025045	65 3510
	87°	15043625087	60 3240
110	45°	15045421045	45 540
	87°	15046021087	40 480



Pies cur ire PP alb

PP white access pipe with cap

D (mm)	Cod code/		
50	15160425000	20	1080
110	15160821000	30	360



Ramifica ie PP alb

PP white branch

D/D1 (mm)	Cod code/		
32/32	45°	15080223245	40 4480
	87°	15080623287	40 4480
40/40	45°	15080824045	50 2700
	87°	15081224087	60 3240
50/40	45°	15100825045	40 1620
	45°	15081425045	50 1800
110/50	87°	15081825087	55 1980
	45°	15103221045	35 420
110/110	87°	15103621087	40 480
	45°	15082621045	20 240
	87°	15083021087	20 240



- numar bucati ambalate / number of the packed items /

*pe baza de comanda / upon firm request /

instalații pentru apă, gaz și canalizare

Accesorii

Accessories / A a

Brid fixare cu diblu OL/ZN, garnitur antizgomot
Galvanized iron pipe clip with anchor for attachment to walls, sound proofed seal

D (mm)	Cod code/	
32	66700032000	200
40	66700040000	150
50	66700050000	125
63	66700063000	100
75	66700075000	60
90	66700090000	50
110	66700110000	50
125	66700125000	50
160	66700160000	30
200	66700200000	30

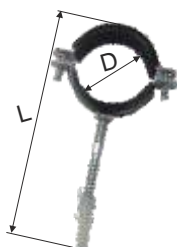

Brid fixare cu diblu OL/ZN
Galvanized iron pipe clip with anchor for attachment to walls

D (mm)	Cod code/	
32	66800026000	200
40	13950104000	50
50	13950305000	50
63	13950506300	50
75	13950707500	25
110	13951111000	25
125	13951312500	25
160	13951516000	10

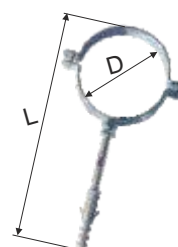

Diblu i holtsurub pentru coliere reglabile M8 L100
Dowel and screw for M8 L100 adjustable clips

L (mm)	Cod code/	
100	13971000000*	1



Coliere PP reglabile tuburi EasyKIT
Adjustable PP clips EasyKIT pipes

D (mm)	Cod code/	
32/40/50	13970032050	1
75/110	13970075110	1



Racord alb WC cu garnitur - htsc
Htsc WC white ring seal coupling

D (mm)	L (mm)	Cod code/	
110	230	15360111023	20
110	400	15360311040	1



Racord flexibil WC
WC flexible coupling

D (mm)	L (mm)	Cod code/	
90-110	230-570	15360000110	1



Bar filetat pentru puncte fixe
Threaded rod M10

D	L (mm)	Cod code/	
M10	1000	14080101000	1
M8	1000	14080081000	1

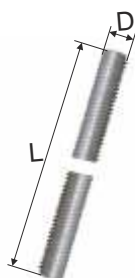

Clapet PP antiretur D.50
Non return PP valve D.50

D (mm)	Cod code/	
50	13980000050	1



Lubrifiant pentru mufe
Lubricant

Cantitate (g) weight/	Cod code/	
150	19000010000	1
250	19000030000	1



*pe baza de comanda / upon firm request /
- numar bucati ambalate / number of the packed items /



Scheme tip pentru canalizare interioară

Scheme for interior sewage /

Bideu/ Bidet/

1. Curb tehnică
Bend /
2. Cot la 87° 30'
Bend at 87° 30' / 87° 30'
3. Tub
Pipe /
4. Ramifica ie la 45°
Branch at 45° / 45°
5. Sifon
Trap /

Cadă/Bath tube/

6. Coloană cadă
Bath tube waste pipe /
7. Sifon cadă
Bath trap /

Spălător/ Sink/

8. Curbă tehnică
Bend /
9. Tub
Pipe /
10. Cot la 87° 30'
Bend at 87° 30' / 87° 30'
11. Tub
Pipe /
12. Cot la 45°
Bend at 45° / 45°
13. Ramifica ie la 45°
Branch at 45° / 45°
14. Ventil de scurgere
Sink drain /

Ma înă de spălat/Washing machine/

15. Sifon ma înă de spălat
Washing machine trap
16. Tub
Pipe /
17. Cot la 87° 30'
Bend at 87° 30' / 87° 30'
18. Tub
Pipe /
19. Cot la 45°
Bend at 45° / 45°
20. Receptor pardoseală
Straight terras drain /

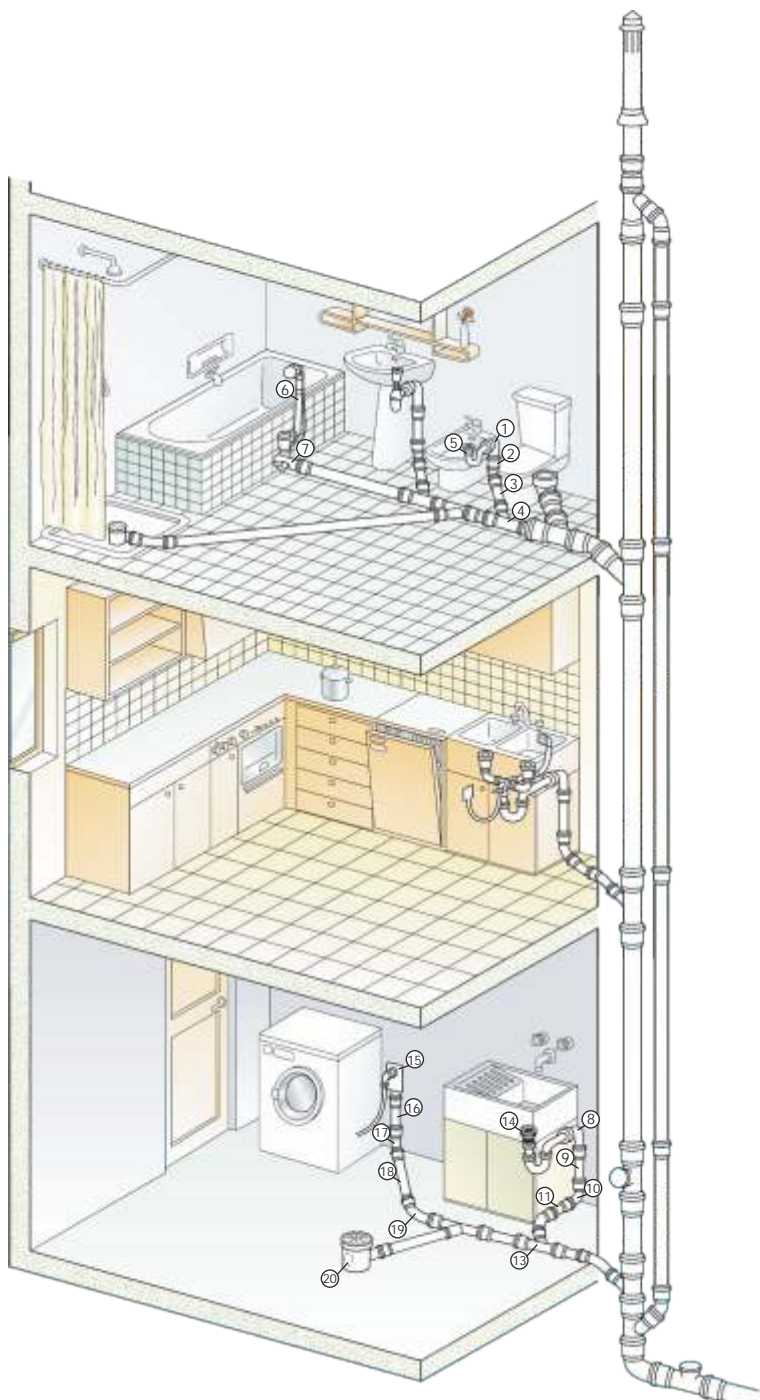

*pe baza de comanda / upon firm request /
- numar bucati ambalate / number of the packed items /