

Service Manual

EasyFit Series VRF



MVi-252WV2RN1(B)

MVi-280WV2RN1(B)

MVi-335WV2RN1(B)

MVi-400WV2RN1(A)

MVi-450WV2RN1(A)



MVi-500WV2RN1(A)

MVi-560WV2RN1(A)

MVi-615WV2RN1(A)

CONTENTS

Part 1 General Information	3
Part 2 Component Layout and Refrigerant Circuits.....	17
Part 3 Control.....	26
Part 4 Field Settings	48
Part 5 Electrical Components and Wiring Diagrams.....	62
Part 6 Diagnosis and Troubleshooting.....	75

Part 1

General Information

1 Indoor and Outdoor Unit Capacities.....	4
2 External Appearance.....	6
3 Nomenclature.....	8
4 Combination Ratio.....	11
5 Selection Procedure.....	12

1 Indoor and Outdoor Unit Capacities

1.1 Indoor Units

1.1.1 Standard indoor units

Table 1-1.1: Standard indoor unit abbreviation codes

Abbreviation code	Type
Q1	One-way Cassette
Q2	Two-way Cassette
Q4C	Compact Four-way Cassette
Q4	Four-way Cassette
T3	Arc Duct
T2	Medium Static Pressure Duct

Abbreviation code	Type
T1	High Static Pressure Duct
G	Wall-mounted
DL	Ceiling & Floor
F	Floor Standing (Exposed/Concealed)
FS	Floor Standing

Table 1-1.2: Standard indoor unit capacity range

Capacity		Capacity index	Q1	Q2	Q4C	Q4	T3	T2	T1	G	DL	F	FS
kW	HP												
1.5	0.5	15	—	—	15	—	15	15	—	—	—	—	—
1.8	0.6	18	18	—	—	—	—	—	—	—	—	—	—
2.2	0.8	22	22	22	22	—	22	22	—	22	—	22	—
2.8	1	28	28	28	28	28	28	28	—	28	—	28	—
3.6	1.25	36	36	36	36	36	36	36	—	36	36	36	—
4.5	1.6	45	45	45	45	45	45	45	—	45	45	45	—
5.6	2	56	56	56	56	56	56	56	—	56	56	56	—
6.3	2.25	63	—	—	63	—	—	—	—	—	—	—	—
7.1	2.5	71	71	71	—	71	71	71	71	71	71	71	—
8.0	3	80	—	—	—	80	80	80	80	80	80	80	—
9.0	3.2	90	—	—	—	90	90	90	90	90	90	—	—
10.0	3.6	100	—	—	—	100	100	—	—	—	—	—	—
11.2	4	112	—	—	—	112	112	112	112	—	112	—	—
12.5	4.5	125	—	—	—	—	—	125	—	—	—	—	—
14.0	5	140	—	—	—	140	—	140	140	—	140	—	—
16.0	6	160	—	—	—	160	—	160	160	—	160	—	—
20.0	7	200	—	—	—	—	—	—	200	—	—	—	—
22.4	8	224	—	—	—	—	—	—	—	—	—	—	224
25.0	9	250	—	—	—	—	—	—	250	—	—	—	—
28.0	10	280	—	—	—	—	—	—	280	—	—	—	280
40.0	14	400	—	—	—	—	—	—	400	—	—	—	—
45.0	16	450	—	—	—	—	—	—	450	—	—	—	—
56.0	20	560	—	—	—	—	—	—	560	—	—	—	—

1.1.2 Fresh air processing unit

Table 1-1.3: Fresh air processing unit capacity range

Capacity	11.2kW	12.5kW	14kW	20kW	25kW	28kW	45kW	56kW
Capacity index	112	125	140	200	250	280	450	560

1.2 Heat recovery ventilator

Table 1-1.4: Heat recovery ventilator capacity range

Airflow rate	200m ³ /h	300m ³ /h	400m ³ /h	500m ³ /h	800m ³ /h	1000m ³ /h	1500m ³ /h	2000m ³ /h
--------------	----------------------	----------------------	----------------------	----------------------	----------------------	-----------------------	-----------------------	-----------------------

1.3 Outdoor Units

Table 1-1.5: Outdoor unit capacity range

Capacity	Model Name	Combination Type
8HP	MVi-252WV2RN1(B)	/
10HP	MVi-280WV2RN1(B)	/
12HP	MVi-335WV2RN1(B)	/
14HP	MVi-400WV2RN1(A)	/
16HP	MVi-450WV2RN1(A)	/
18HP	MVi-500WV2RN1(A)	/
20HP	MVi-560WV2RN1(A)	/
22HP	MVi-615WV2RN1(A)	/

Notes:











1. EasyFit outdoor units could not be combined.

2 External Appearance

2.1 Indoor Units



2.1.1 Standard indoor units

Table 1-2.1: Standard indoor unit appearance

One-way Cassette Q1 	Two-way Cassette Q2 
Compact Four-way Cassette Q4C 	Four-way Cassette Q4 
Arc Duct T3 	Medium Static Pressure Duct T2 
High Static Pressure Duct T1 	Floor Standing FS 
Wall-mounted G 	Ceiling & Floor DL 
Floor Standing F 	

2.1.2 Fresh air processing unit

Table 1-2.2: Fresh air processing unit appearance



Fresh Air Processing Unit FA 	Small Airflow Rate Fresh Air Processing Unit FA 
--	---

2.2 Heat Recovery Ventilator

Table 1-2.3: Heat recovery ventilator appearance

Heat Recovery Ventilator 

2.3 Outdoor Units**2.3.1 Single units***Table 1-2.4: Single outdoor unit appearance*

8/10/12/14HP	16/18/20/22HP
	

3 Nomenclature

3.1 Indoor Units

3.1.1 Standard indoor units

V8 indoor units

M I H 18 Q1 N18
 ① ② ③ ④ ⑤ ⑦

Legend		
No.	Code	Remarks
1	M	Midea
2	I	VRF indoor unit
3	H	Function code H: HyperLink function
4	22	Capacity index (the capacity in kW multiplied by 10)
5	Q1	Indoor unit type Q1: One-way Cassette Q2: Two-way Cassette Q4C: Compact Four-way Cassette Q4: Four-way Cassette T3: Arc Duct T2: Medium Static Pressure Duct T1: High Static Pressure Duct G: Wall-mounted DL: Ceiling & Floor F: Floor Standing (Exposed/Concealed) FS: Floor Standing
6	-	Power supply Omit: 1 phase, 220-240V, 50Hz H: 1 phase, 220-240V, 50/60Hz
7	N18	Refrigerant type (N18: R410A&R32)

M **I** **2** **=** **22** **Q1** **D** **N1**
 ① ② ③ ④ ⑤ ⑥ ⑧

Legend		
No.	Code	Remarks
1	M	Midea
2	I	VRF indoor unit
3	2	Generation code 2: The 2nd generation 3: The 3rd generation
4	22	Capacity index (the capacity in kW multiplied by 10)
5	Q1	Indoor unit type Q1: One-way Cassette Q2: Two-way Cassette Q4C: Compact Four-way Cassette Q4: Four-way Cassette T2: Medium Static Pressure Duct T1: High Static Pressure Duct G: Wall-mounted DL: Ceiling & Floor F: Floor Standing
6	D	Series category (D: DC series)
7		Power supply Omit: 1 phase, 220-240V, 50Hz H: 1 phase, 220-240V, 50/60Hz
8	N1	Refrigerant type (N1: R410A)

AC indoor units

MDV **-** **D** **18** **=** **Q4** **/** **N1** **E** **(B)**
 ① ② ③ ④ ⑤ ⑥ ⑦

Legend		
No.	Code	Remarks
1	MDV	Midea
2	D	VRF indoor unit
3	22	Capacity index (the capacity in kW multiplied by 10)
4	Q1	Indoor unit type Q1: One-way Cassette Q2: Two-way Cassette Q4C: Compact Four-way Cassette Q4: Four-way Cassette T2: Medium Static Pressure Duct T1: High Static Pressure Duct G: Wall-mounted DL: Ceiling & Floor F: Floor Standing
5	N1	Refrigerant N1: R410A
6	E	Design Code
7	(B)	Second Generation

3.1.2 Fresh air processing unit

M **I** **2** **=** **280** **FA** **D** **N1** **=** **S**
 ① ② ③ ④ ⑤ ⑥ ⑧ ⑨

Legend		
No.	Code	Remarks
1	M	Midea
2	I	VRF indoor unit
3	2	The 2 nd generation VRF DC indoor unit
4	280	Capacity index (the capacity in kW multiplied by 10)
5	FA	Indoor unit type FA: Fresh Air Processing Unit
6	D	Series category (D: DC series)
7		Power supply Omit: 1 phase, 220-240V, 50Hz H: 1 phase, 220-240V, 50/60Hz
8	N1	Refrigerant type (N1: R410A)
9	S	Product series S: Small Airflow Rate

3.1.3 Heat recovery ventilator

AC Series

HRV **=** **200**
 ① ②

Legend		
No.	Code	Remarks
1	HRV	Heat recovery ventilator
2	200	Airflow in m ³ /h

DC Series

HRV **=** **D** **200**
 ① ② ③

Legend		
No.	Code	Remarks
1	HRV	Heat recovery ventilator
2	D	Series category (D: DC series)
3	200	Airflow in m ³ /h

3.2 Outdoor Units

MV i - 400 W V2 R N1 (A)
 ① ② ③ ④ ⑤ ⑥ ⑦ ⑧

Legend		
No.	Code	Remarks
1	MV	Midea VRF
2	i	Individual series
3	400	Capacity index (the capacity in kW multiplied by 10)
4	W	Unit category (W: VRF outdoor unit)
5	V2	Type (V2: All DC inverter)
6	R	Power supply G:380-415V, 3N~, 50/60Hz R:380-415V, 3N~, 50Hz
7	N1	Refrigerant type (N1: R410A)
8	(A)	Product version code

4 Combination Ratio

$$\text{Combination ratio} = \frac{\text{Sum of capacity indexes of the indoor units}}{\text{Capacity index of the outdoor units}}$$

Table 1-5.1: Indoor and outdoor unit combination ratio limitations

Type	Minimum combination ratio	Maximum combination ratio		
		Standard indoor units only	Fresh air processing units only	Fresh air processing units and standard indoor units together
EasyFit Series outdoor units	50%	200% ^{1,2,3} (Single ODU)	100%	100% ⁴

- Notes:
- All the indoor units connected should be indoor units with ø5mm size copper tube heater exchanger. This limitation is to avoid too big indoor unit exchanger cause reliability and performance problem.
 - Piping between farthest indoor unit and first indoor branch joint should less than 40m.
 - Combination ratio greater than 130% is available as a customization option.
 - When fresh air processing units are installed together with standard indoor units, the total capacity of the fresh air processing units must not exceed 30% of the total capacity of the outdoor units and the total combination ratio must not exceed 100%.

Table 1-5.2: Combinations of indoor and outdoor units

Outdoor unit capacity			Sum of capacity indexes of connected indoor units (standard indoor units only)	Sum of capacity indexes of connected indoor units (fresh air processing units and standard indoor units together)	Maximum number of connected indoor units
kW	HP	Capacity index			
25.2	8	252	126 to 327.6	126 to 252	13
28	10	280	140 to 364	140 to 280	16
33.5	12	335	167.5 to 435.5	167.5 to 335	19
40.0	14	400	200 to 520	200 to 400	22
45.0	16	450	225 to 585	225 to 450	26
50.0	18	500	250 to 650	250 to 500	29
56.0	20	560	280 to 728	280 to 560	33
61.5	22	615	307.5 to 799.5	307.5 to 615	36

5 Selection Procedure

5.1 Procedure

Step 1: Establish design conditions

Design temperature and humidity (indoor and outdoor)
 Required heat load of each room
 System peak load
 Piping length, level differences
 Indoor unit specifications (type and quantity)

Step 2: Select indoor units

Decide indoor unit safety factor

Select indoor unit models ensuring that:
 Indoor unit capacity corrected for indoor air temperature $WB^1 \geq$ Required heat load \times Indoor unit safety factor

Step 3: Select outdoor units

Determine required total heat load on outdoor units

Use the sum of the peak load of each room Use the system peak load

Provisionally select outdoor unit capacity based on combination ratio limitations

Confirm that the number of indoor units connected to the outdoor units is within limitation

Correct cooling and heating capacities of the outdoor units for the following items:
 Outdoor air temperature / Indoor air temperature WB / Combination ratio / Piping length, level difference / Piping heat loss / Frost accumulation (for heating capacity only)

Is corrected outdoor unit capacity \geq Required total heat load on outdoor units?

No

Yes

VRF system selection is complete

Notes:

1. If the indoor design temperature falls between two temperatures listed in the indoor unit's capacity table, calculate the corrected capacity by interpolation. If the indoor unit selection is to be based on total heat load and sensible heat load, select indoor units which satisfy not only the total heat load requirements of each room but also the sensible heat load requirements of each room. As with total heat capacity, the sensible heat capacity of indoor units should be corrected for indoor temperature, interpolating where necessary. For the indoor unit capacity tables, refer to the indoor unit technical manuals.

5.2 Example

The following is a selection example based on total heat load for cooling.

Figure 1-6.1: Room plan

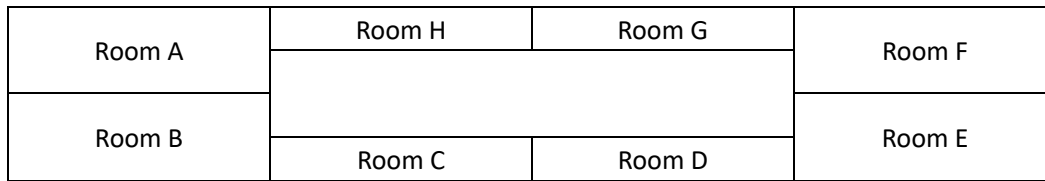

Step 1: Establish design conditions

- Indoor air temperature 25.8°C DB, 18°C WB; outdoor air temperature 33°C DB.
- Determine peak load of each room and system peak load. As shown in Table 1-6.1, the system peak load is 50.7kW.

Table 1-6.1: Required heat load of each room (kW)

Time	Room A	Room B	Room C	Room D	Room E	Room F	Room G	Room H	Total
9:00	4.8	4.8	3.0	3.0	9.1	9.0	2.9	2.9	39.5
12:00	6.6	7.1	5.1	5.1	7.4	6.8	4.0	4.0	46.1
14:00	9.0	9.4	4.9	4.9	7.3	6.8	4.2	4.2	50.7
16:00	10.6	10.7	3.9	3.9	6.3	6.2	3.8	3.8	49.2

- The maximum piping lengths and level differences in this example are as given in Figure 1-6.2.

Figure 1-6.2: System diagram

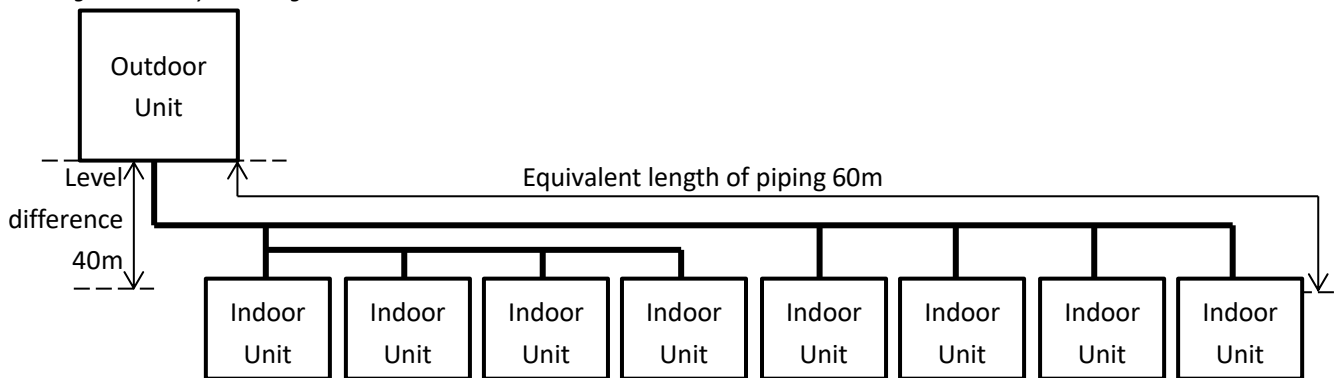

- Indoor unit type for all rooms: Medium Static Pressure Duct (T2).

Step 2: Select indoor units

- In this example, a safety factor is not used (i.e. the safety factor is 1).
- Select indoor unit models using the medium static pressure duct cooling capacity table. Each indoor unit's corrected capacity needs to be greater than or equal to the peak load of the relevant room. The selected indoor units are shown in Table 1-6.3.

Table 1-6.2: Extract from medium static pressure duct (T2) cooling capacity table

Model	Capacity index	Indoor air temperature													
		14°C WB		16°C WB		18°C WB		19°C WB		20°C WB		22°C WB		24°C WB	
		20°C DB		23°C DB		26°C DB		27°C DB		28°C DB		30°C DB		32°C DB	
		TC	SC	TC	SC	TC	SC	TC	SC	TC	SC	TC	SC	TC	SC
T2	22	1.5	1.4	1.8	1.5	2.1	1.6	2.2	1.6	2.3	1.7	2.4	1.5	2.4	1.5
	28	1.9	1.7	2.3	1.9	2.6	2.1	2.8	2.1	3.0	2.1	3.1	2.0	3.1	1.9
	36	2.5	2.1	2.9	2.3	3.4	2.5	3.6	2.6	3.8	2.7	4.2	2.8	3.9	2.3
	45	3.1	2.6	3.7	2.8	4.2	3.1	4.5	3.2	4.8	3.2	4.9	3.1	5.1	2.9
	56	3.9	3.0	4.6	3.3	5.3	3.6	5.6	3.7	5.9	3.8	6.2	3.7	6.2	3.4
	71	4.9	3.9	5.8	4.3	6.7	4.7	7.1	4.9	7.5	4.8	7.8	4.6	7.8	4.3
	80	5.5	4.4	6.6	4.9	7.5	5.3	8.0	5.5	8.4	5.5	8.8	5.2	8.8	4.8
	90	6.2	5.3	7.3	5.8	8.4	6.3	9.0	6.4	9.6	6.5	9.9	6.1	9.9	5.7
	112	7.7	6.4	9.1	7.1	10.5	7.7	11.2	7.8	11.9	8.1	12.5	7.8	12.5	7.4
	140	9.7	7.8	11.3	8.6	13.2	9.6	14.0	9.8	14.8	9.8	15.7	9.7	15.4	8.8

Abbreviations:

TC: Total capacity (kW); SC: Sensible capacity (kW)

Table 1-6.3: Selected indoor units

	Room A	Room B	Room C	Room D
Peak heat load (kW)	10.6	10.7	5.1	5.1
Selected indoor unit	MI2-140T2DHN1	MI2-140T2DHN1	MI2-56T2DHN1	MI2-56T2DHN1
Corrected TC (kW)	13.2	13.2	5.3	5.3
	Room E	Room F	Room G	Room H
Peak heat load (kW)	9.1	9.0	4.2	4.2
Selected indoor unit	MI2-112T2DHN1	MI2-112T2DHN1	MI2-45T2DHN1	MI2-45T2DHN1
Corrected TC (kW)	10.5	10.5	4.2	4.2

Step 3: Select outdoor units

- Determine the required total heat load from the indoor units to the outdoor units based on either the sum of the peak loads of each room or the system peak load. In this example, it is determined based on the system peak load. Therefore, the required heat load is 50.7kW.
- Provisionally select outdoor units using the sum of the capacity indexes (CIs) of the selected indoor units (as shown in Table 1-6.4), ensuring that the combination ratio is between 50% and 130%. Refer to Table 1-6.5. As the sum of CIs of the indoor units is 706, outdoor units from 20HP to 24HP are potentially suitable. Start from the smallest, which is the 20HP unit.

Table 1-6.4: Sum of indoor unit capacity indexes

Model	Capacity Index	No. of units
MI2-140T2DHN1	140	2
MI2-112T2DHN1	112	2
MI2-56T2DHN1	56	2
MI2-45T2DHN1	45	2
Sum of CIs	706	

Table 1-6.5: Extract from Table 1-5.2 Combinations of Indoor and outdoor units

Outdoor unit capacity			Sum of capacity indexes of connected indoor units (standard indoor units only)	Maximum number of connected indoor units
kW	HP	Capacity index		
25.2	8	252	126 to 327.6	13
28	10	280	140 to 364	16
33.5	12	335	167.5 to 435.5	19
40.0	14	400	200 to 520	22
45.0	16	450	225 to 585	26
50.0	18	500	250 to 650	29
56.0	20	560	280 to 728	33
61.5	22	615	307.5 to 799.5	36

- The number of connected indoor units is 8 and the maximum number of connected indoor units on the 20HP outdoor unit is 33, so the number of connected indoor units is within the limitation.
- Calculate the corrected capacity of the outdoor units:
 - a) The sum of the indoor unit CIs is 706 and the CI of the 20HP outdoor unit MVi-560WV2RN1(A) is 560, so the combination ratio is $706 / 560 = 126\%$.
 - b) Using the outdoor units' cooling capacity table, interpolate to obtain the capacity ("B") corrected for outdoor air temperature, indoor air temperature, and combination ratio. Refer to Tables 1-6.6 and 1-6.7.

Table 1-6.6: MVi-560WV2RN1(A) cooling capacity

CR	Outdoor air temp. (°C DB)	Indoor air temp. (°C DB / °C WB)	
		25.8 / 18.0	
		TC	PI
		kW	kW
130%	31	62.05	22.66
	33	60.99	23.42
	35	59.94	24.17
120%	31	60.25	22.56
	33	59.21	23.33
	35	58.19	24.08

Table 1-6.7: Cooling capacity calculated by interpolation

CR	Outdoor air temp. (°C DB)	Indoor air temp. (°C DB / °C WB)	
		25.8 / 18.0	
		TC	PI
		kW	kW
130%			
	33	60.99	23.42
120%		B = 60.28¹	
	33	59.21	23.33

Notes:

1. $59.21 + (60.99 - 59.21) \times (126 - 120) / (130 - 120) = 60.28$

c) Find the correction factor for piping length and level difference (“K1”)

Figure 1-6.3: EasyFit rate of change in cooling capacity

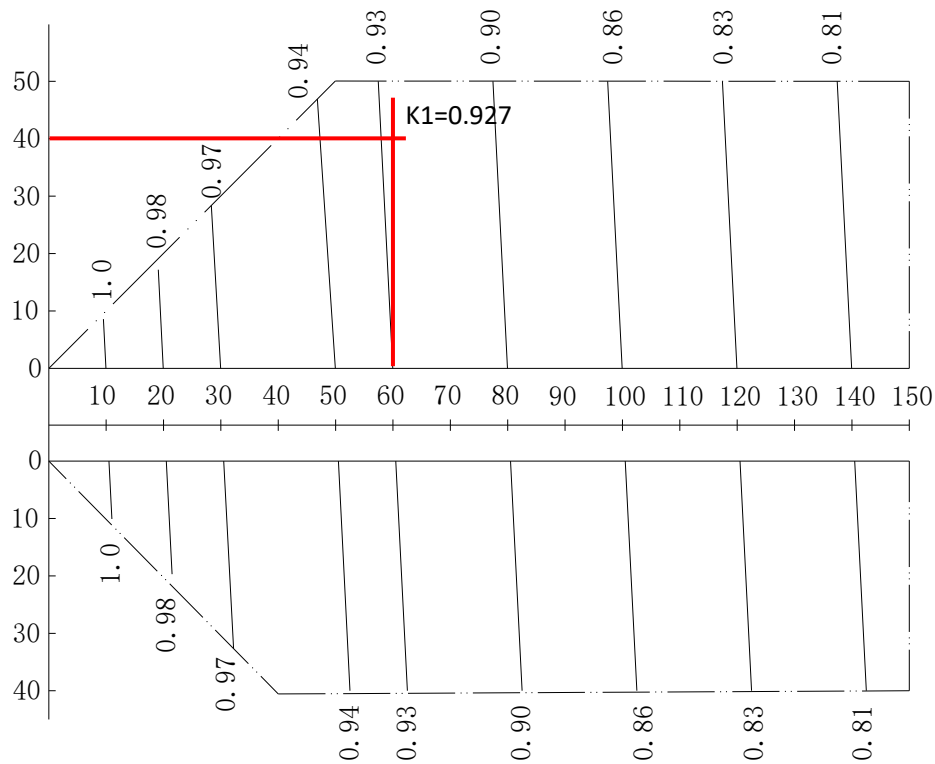

Notes:

1. The horizontal axis shows equivalent length of piping between farthest indoor unit and first outdoor branch joint; the vertical axis shows the largest level difference between indoor unit and outdoor unit. For level differences, positive values indicate that the outdoor unit is above the indoor unit, negative values indicate that the outdoor unit is below the indoor unit.

d) Calculate the corrected capacity of MVi-560WV2RN1(A) (“C”) by using K1:

$$C = B \times K1 = 60.28 \times 0.927 = 55.88\text{kW}$$

- The corrected capacity 55.88kW is larger than required total heat load 50.7kW, so selection is complete. (In the event that the corrected capacity is lower than the required total heat load, Step 3 should be repeated from the point where the outdoor unit capacity is provisionally selected.)

Part 2

Component Layout and Refrigerant Circuits

1	Layout of Functional Components.....	18
2	Piping Diagrams	20
3	Refrigerant Flow Diagrams	23

1 Layout of Functional Components

1.1 8-14HP layout of functional components

Figure 2-1.1: 8-14HP layout of functional component

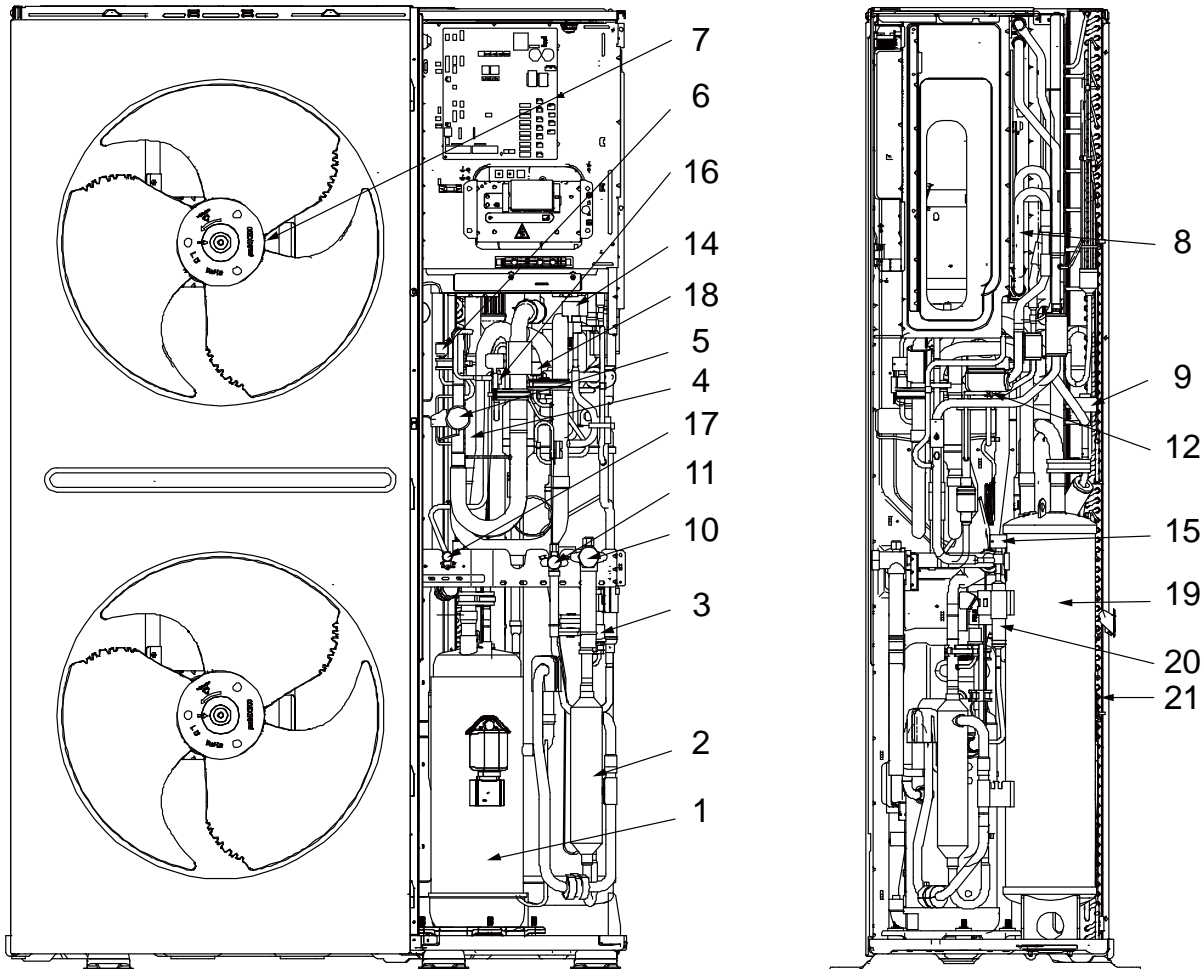

Legend

No.	Parts name	No.	Parts name
1	Compressor	11	Stop valve (liquid side)
2	Oil separator	12	Electronic expansion valve (EEVC)
3	High pressure switch	13	Electronic expansion valve (EEVE)(Optional)
4	Check value	14	Injection bypass solenoid valve(SV5)
5	Four-way valve	15	Compressor vapor injection valve (SV8A)
6	High pressure sensor	16	Hot gas bypass solenoid valve(SV7)
7	Fan	17	Charge port
8	Microchannel heat exchanger	18	Low pressure sensor
9	Electronic expansion valve (EEVA)	19	Gas-liquid separator
10	Stop valve (gas side)	20	Muffler
		21	Heat exchanger

1.2 16-22HP layout of functional components

Figure 2-1.2: 16-22HP layout of functional components

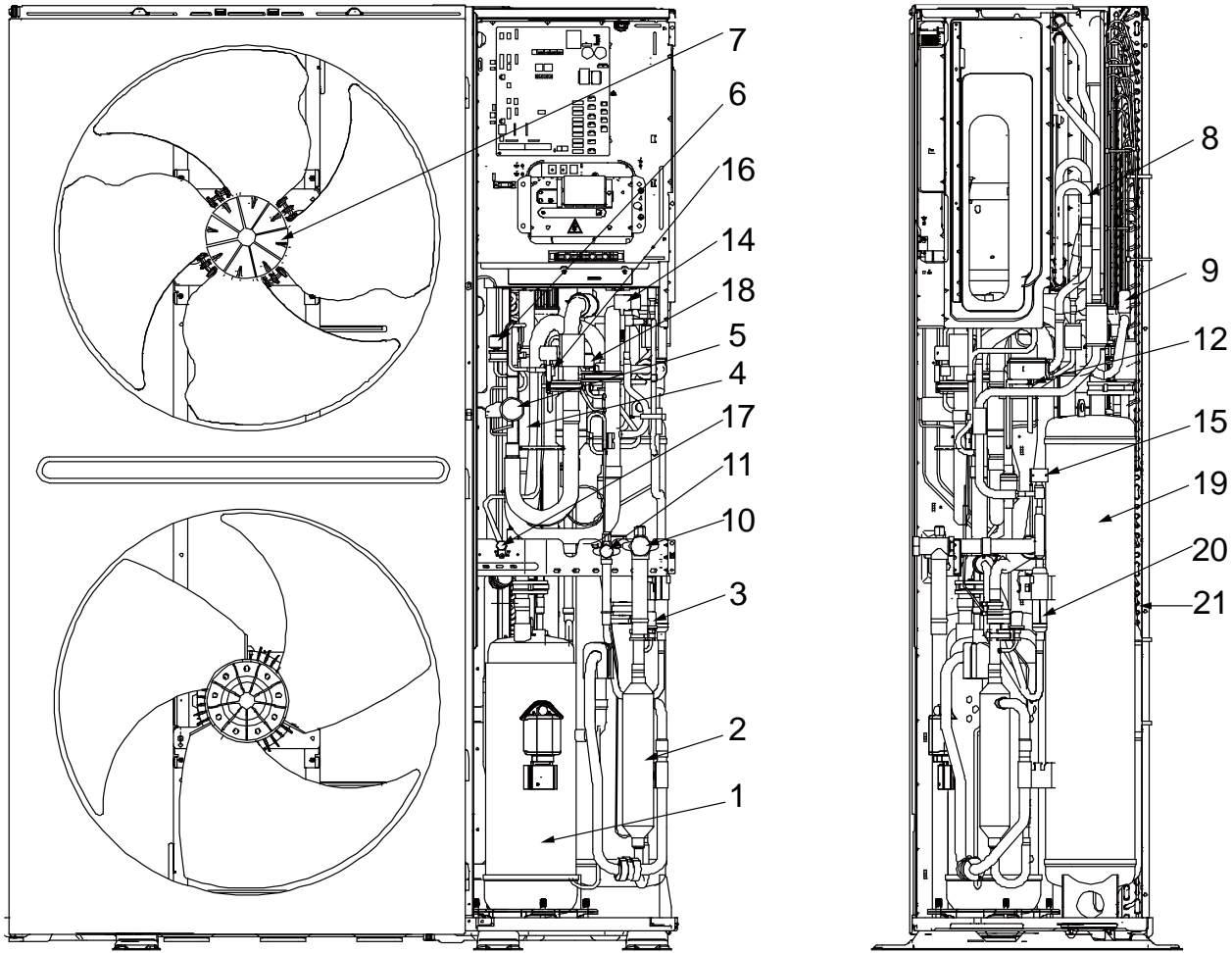

Legend			
No.	Parts name	No.	Parts name
1	Compressor	11	Stop valve (liquid side)
2	Oil separator	12	Electronic expansion valve (EEVC)
3	High pressure switch	13	Electronic expansion valve (EEVE)(Optional)
4	Check value	14	Injection bypass solenoid valve(SV5)
5	Four-way valve	15	Compressor vapor injection valve (SV8A)
6	High pressure sensor	16	Hot gas bypass solenoid valve(SV7)
7	Fan	17	Charge port
8	Microchannel heat exchanger	18	Low pressure sensor
9	Electronic expansion valve (EEVA)	19	Gas-liquid separator
10	Stop valve (gas side)	20	Muffler
		21	Heat exchanger

Note:

There is no SV8A for 20/22HP outdoor units.

2 Piping Diagrams

2.1 8-14HP piping diagram

Figure 2-2.1: 8-14HP piping diagram

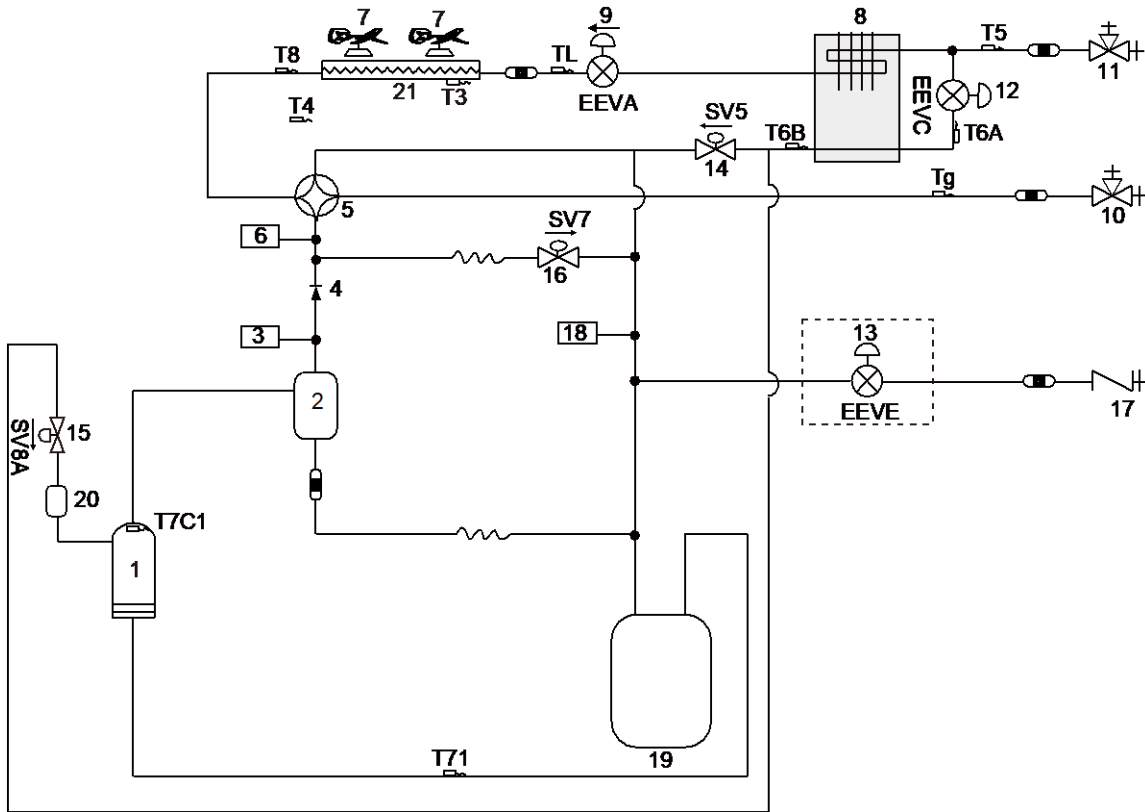

Legend	
No.	Parts name
1	Compressor
2	Oil separator
3	High pressure switch
4	Check value
5	Four-way valve
6	High pressure sensor
7	Fan
8	Microchannel heat exchanger
9	Electronic expansion valve (EEVA)
10	Stop valve (gas side)
11	Stop valve (liquid side)
12	Electronic expansion valve (EEVC)
13	Electronic expansion valve (Optional EEVE)
14	Injection bypass solenoid valve (SV5)
15	Compressor vapor injection valve (SV8A)
16	Hot gas bypass solenoid valve (SV7)
17	Charge port
18	Low pressure sensor
19	Gas-liquid separator
20	Muffler
21	Heat exchanger
Sensor Code	Description
T3	Main exchanger pipe temperature sensor
T4	Outdoor ambient temperature sensor
T5	Liquid pipe temperature sensor
T6A	Microchannel heat exchanger inlet pipe temperature sensor
T6B	Microchannel heat exchanger outlet pipe temperature sensor
T71	Suction temperature sensor
T8	Heat exchanger gas temperature sensor
Tg	Gas pipe temperature sensor
TL	Heat exchanger liquid temperature sensor
T7C1	Compressor discharge temperature sensor

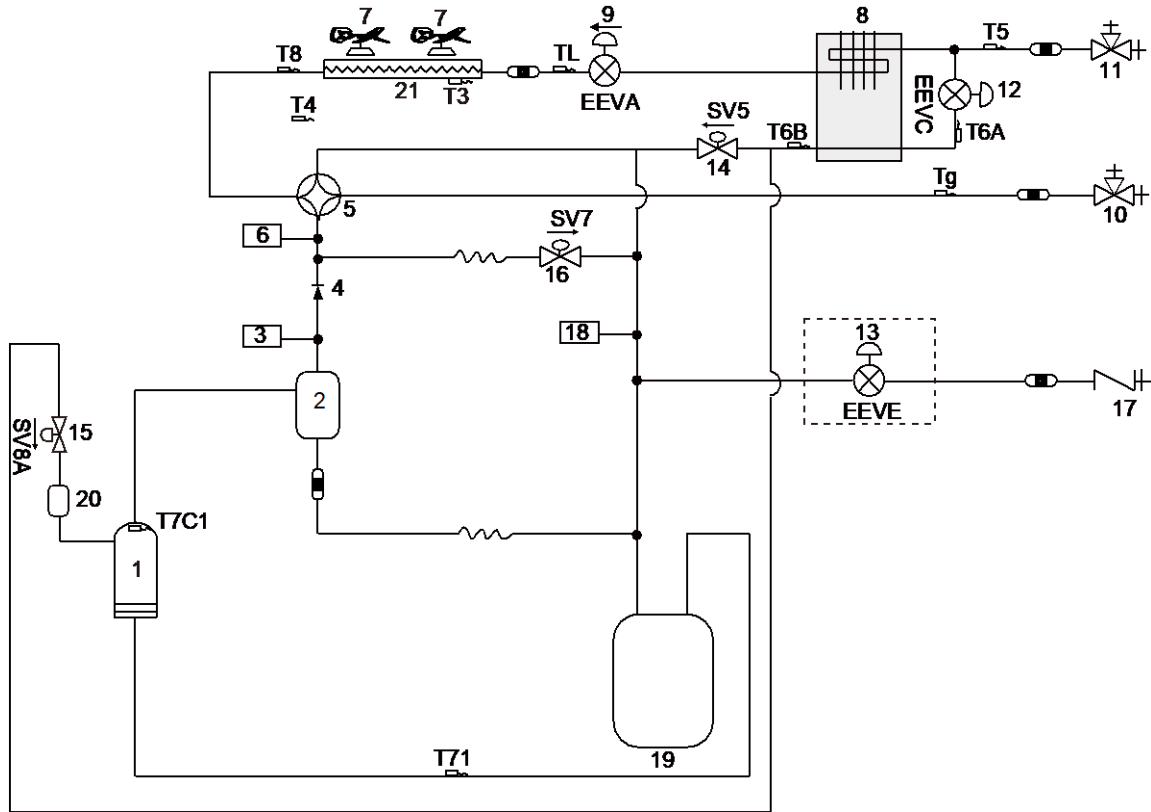
2.2 16-22HP piping diagram
Figure 2-2.2: 16-22HP piping diagram

Legend	
No.	Parts name
1	Compressor
2	Oil separator
3	High pressure switch
4	Check value
5	Four-way valve
6	High pressure sensor
7	Fan
8	Microchannel heat exchanger
9	Electronic expansion valve (EEVA)
10	Stop valve (gas side)
11	Stop valve (liquid side)
12	Electronic expansion valve (EEVC)
13	Electronic expansion valve (Optional EEVE)
14	Injection bypass solenoid valve (SV5)
15	Compressor vapor injection valve (SV8A)
16	Hot gas bypass solenoid valve (SV7)
17	Charge port
18	Low pressure sensor
19	Gas-liquid separator
20	Muffler
21	Heat exchanger
Sensor Code	Description
T3	Main exchanger pipe temperature sensor
T4	Outdoor ambient temperature sensor
T5	Liquid pipe temperature sensor
T6A	Microchannel heat exchanger inlet pipe temperature sensor
T6B	Microchannel heat exchanger outlet pipe temperature sensor
T71	Suction temperature sensor
T8	Heat exchanger gas temperature sensor
Tg	Gas pipe temperature sensor
TL	Heat exchanger liquid temperature sensor
T7C1	Compressor discharge temperature sensor

Note:

There is no SV8A for 20/22HP outdoor units.

2.3 Key components

- 1. Oil separator:**

Separates oil from gas refrigerant pumped out of the compressor and quickly returns it to the compressor. Separation efficiency is up to 99%.
- 2. Gas-liquid separator:**

Separates liquid refrigerant from gas refrigerant, stores liquid refrigerant and oil to protect compressor from liquid hammering.
- 3. Electronic expansion valve (EEVA):**

Controls refrigerant flow and reduces refrigerant pressure.
- 4. Four-way valve:**

Controls heat exchanger function. When open, the heat exchanger functions as an evaporator; When closed, the heat exchanger functions as a condenser. Refer to part 3, "Heat Exchanger Control".
- 5. Microchannel heat exchanger:**

In cooling mode, it can improve super-cooling degree and the super-cooled refrigerant can achieve better heat exchange in indoor units. In heating mode, the refrigerant comes from the microchannel heat exchanger going to the compressor can increase the refrigerant volume and improve the heating capacity in low ambient temperature. Refrigerant volume in microchannel heat exchanger is controlled according to temperature different between microchannel heat exchanger inlet and outlet or the temperature different between discharge temperature and target discharge temperature.
- 6. Solenoid valve SV5:**

Controls the refrigerant from microchannel heat exchanger to gas-liquid separator.
- 7. Solenoid valve SV7:**

Bypass pressure at start-up stage and control capacity at low load condition; High-pressure-rise prevention; Discharge superheat protection.
- 8. Solenoid valve SV8A:**

Allows refrigerant from microchannel heat exchanger inject directly to the compressor. SV8A opens when compressor startup and closes when compressor stop.
- 9. High pressure switch:**

Regulate system pressure. When system pressure rises above the upper limit, the high pressure switch turn off, stopping the compressor. When the high pressure protection recovers, the compressor restarts.
- 10. High/Low pressure sensor**

Used to detect the system high/low pressure.

3 Refrigerant Flow Diagrams

3.1 Cooling operation

Figure 2-3.1: 8-22HP refrigerant flow during cooling operation

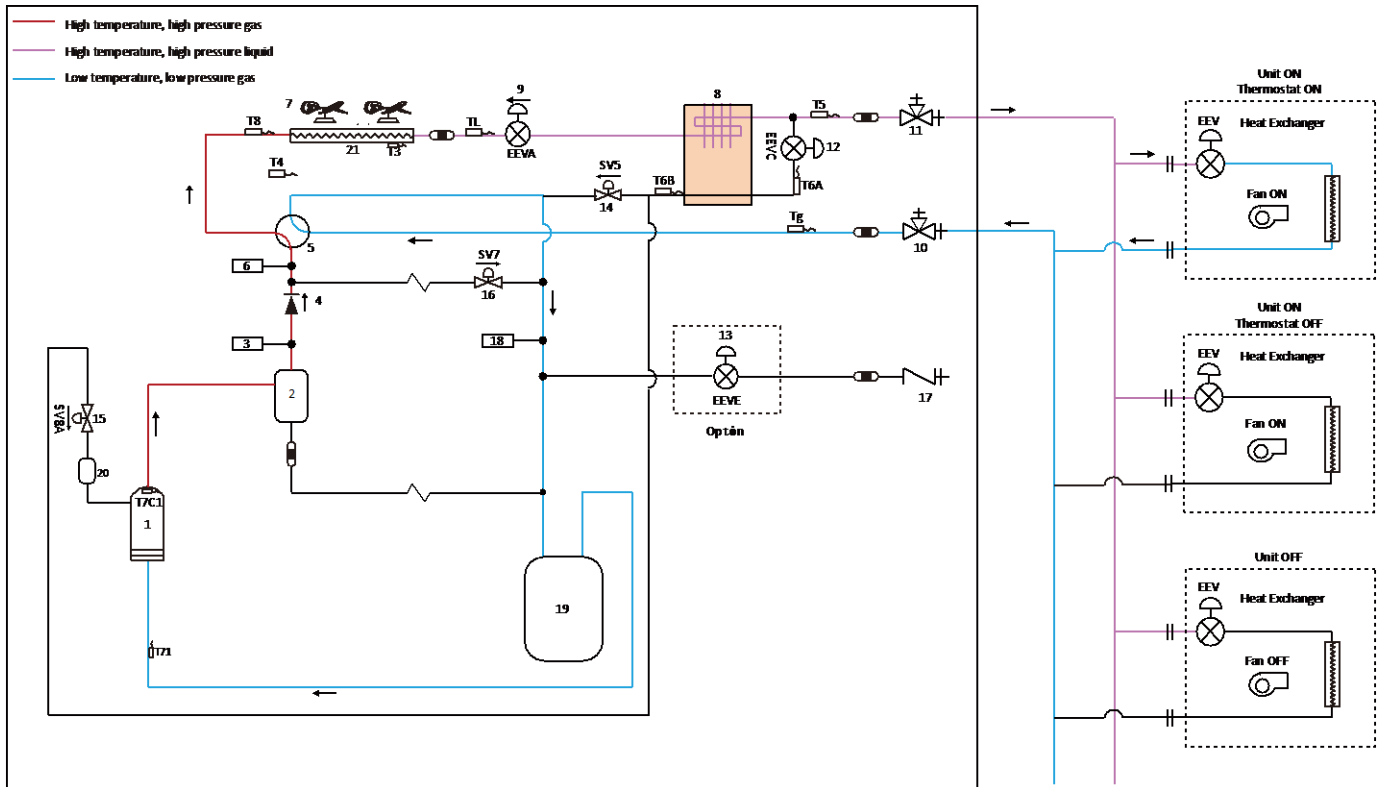

Note: There is no SV8A for 20/22HP outdoor units.

3.2 Heating operation

Figure 2-3.2: 8-22HP refrigerant flow during heating operation

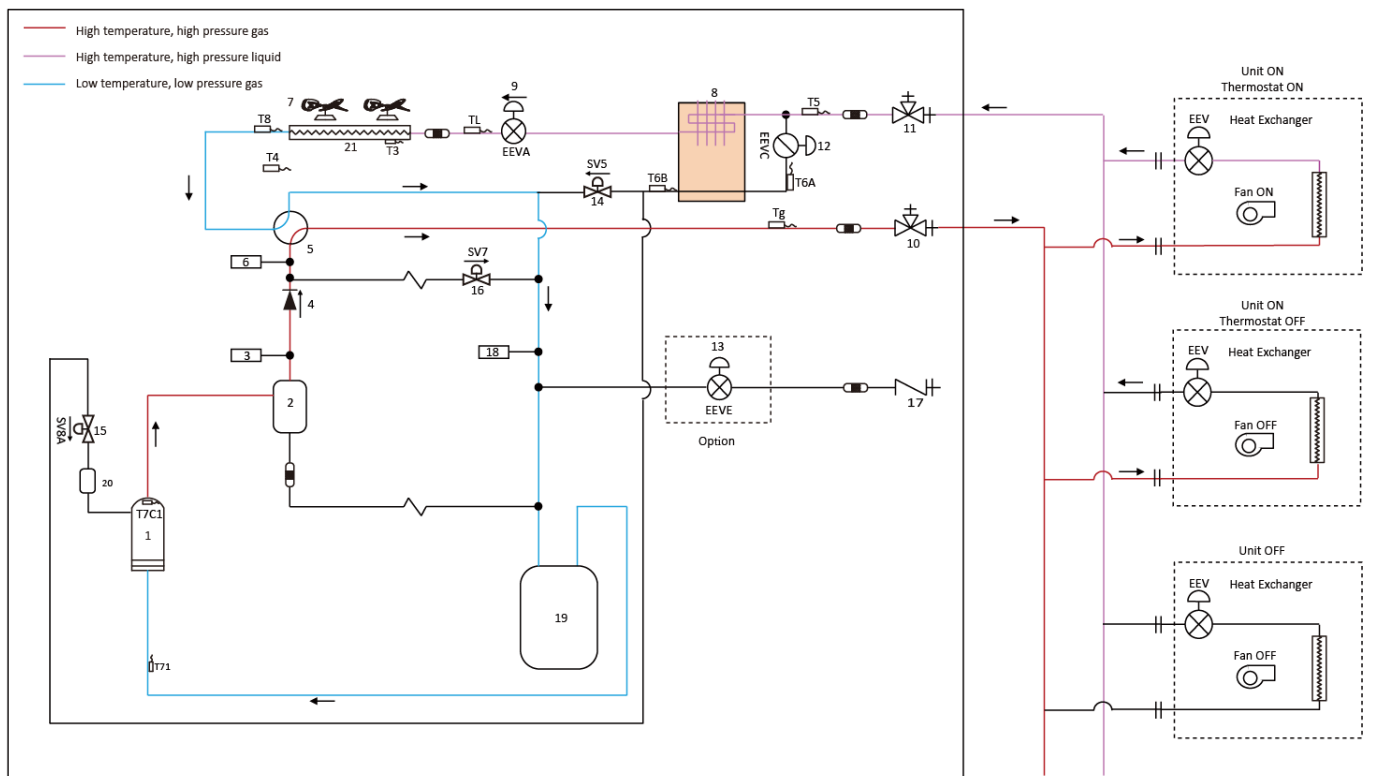

Note: There is no SV8A for 20/22HP outdoor units

3.3 Oil return operation in cooling mode

Figure 2-3.3: 8-22HP refrigerant flow during oil return operation in cooling mode

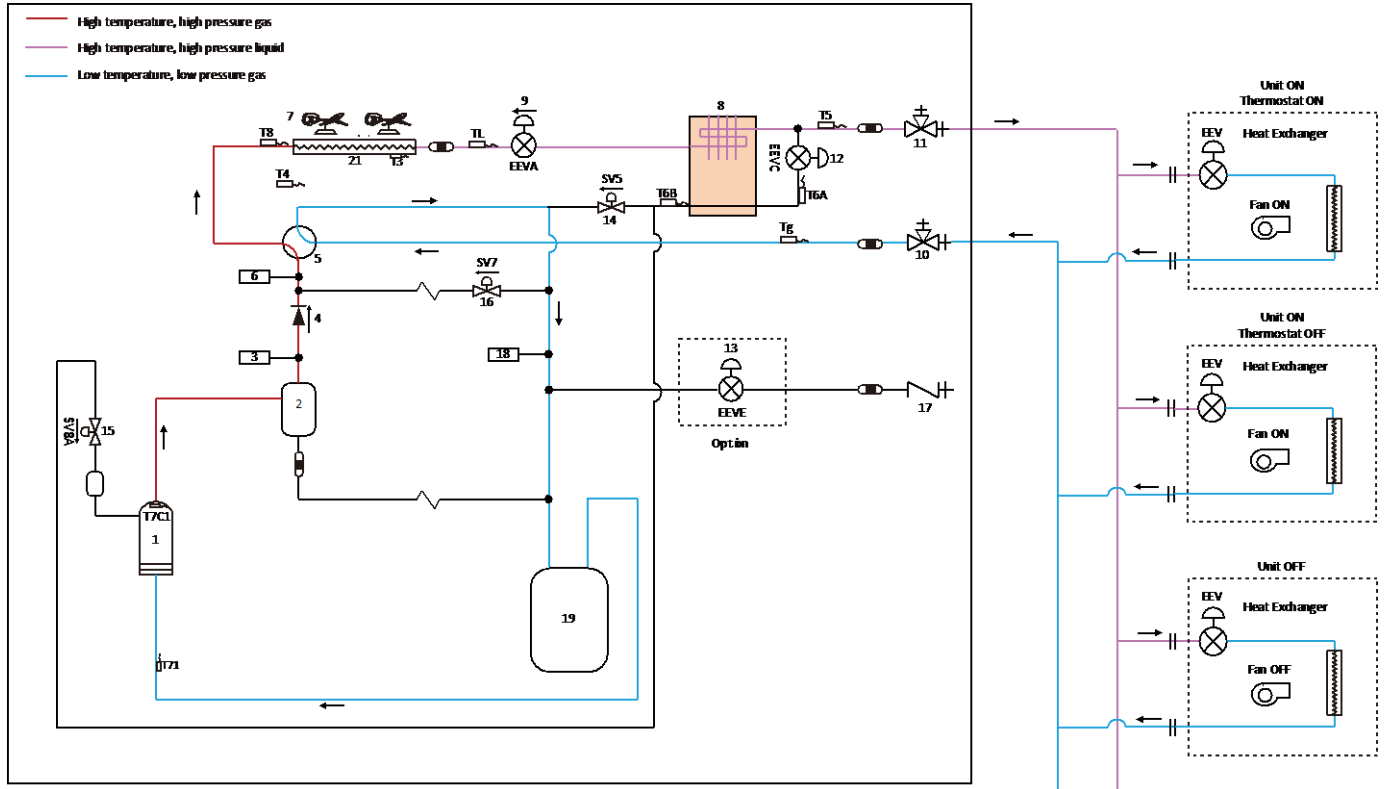

Note: There is no SV8A for 20/22HP outdoor units.

3.4 Oil return operation in heating mode and defrosting operation (4-way valve change direction)

Figure 2-3.4: 8-22HP refrigerant flow during oil return operation in heating mode and defrosting operation (4-way valve change direction)

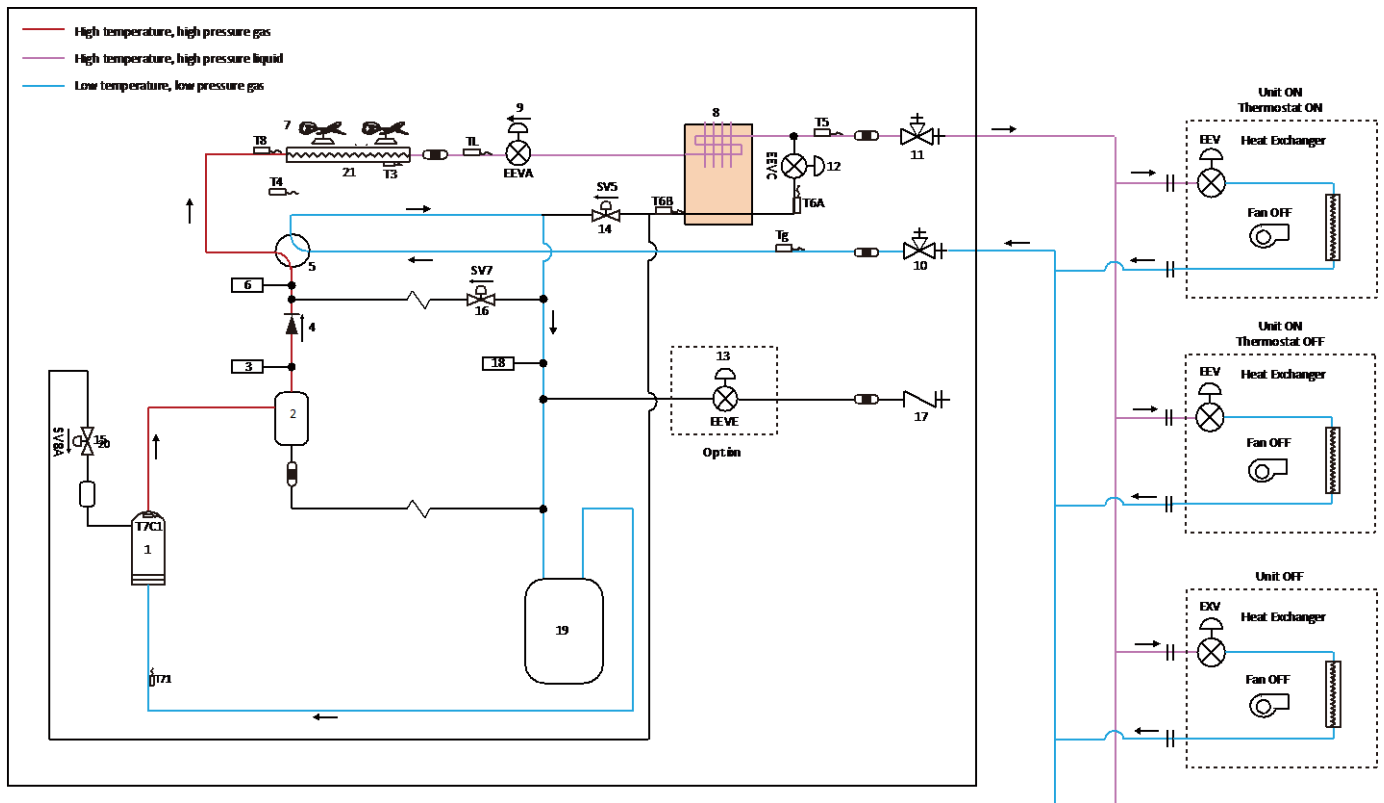

Note: There is no SV8A for 20/22HP outdoor units.

3.5 Oil return operation in heating mode (4-way valve keep in the same direction)

Figure 2-3.5: 8-22HP refrigerant flow during oil return operation in heating mode (4-way valve keep in the same direction)

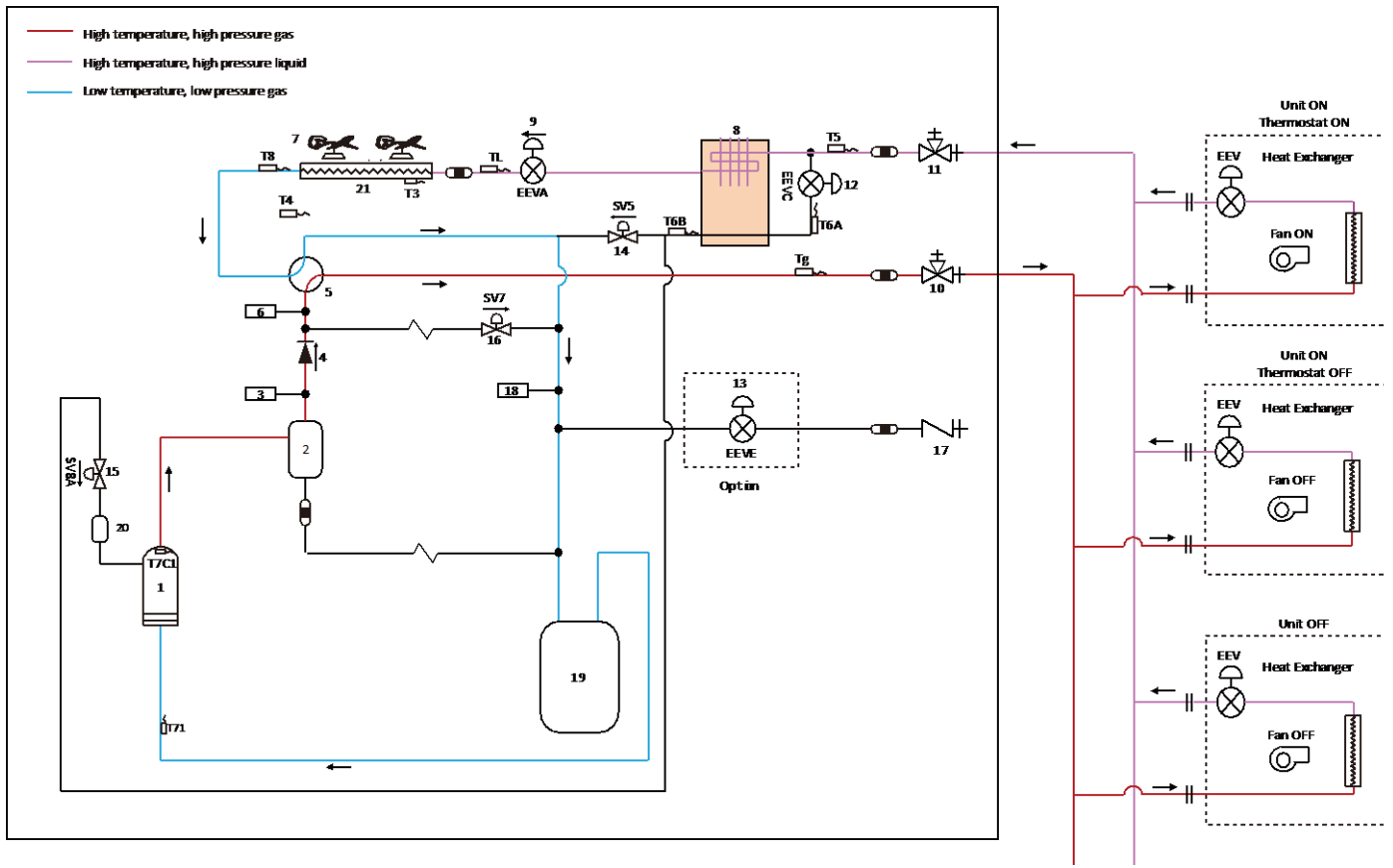

Note: There is no SV8A for 20/22HP outdoor units.

Part 3

Control

1 General Control Scheme Flowchart	27
2 Stop Operation	28
3 Standby Control	29
4 Startup Control	29
5 Normal Operation Control	32
6 Protection Control	38
7 Special Control.....	42
8 Other Control.....	45

1 General Control Scheme Flowchart

Sections 2 to 8 on the following pages detail when each of the controls in the flowchart below is activated.

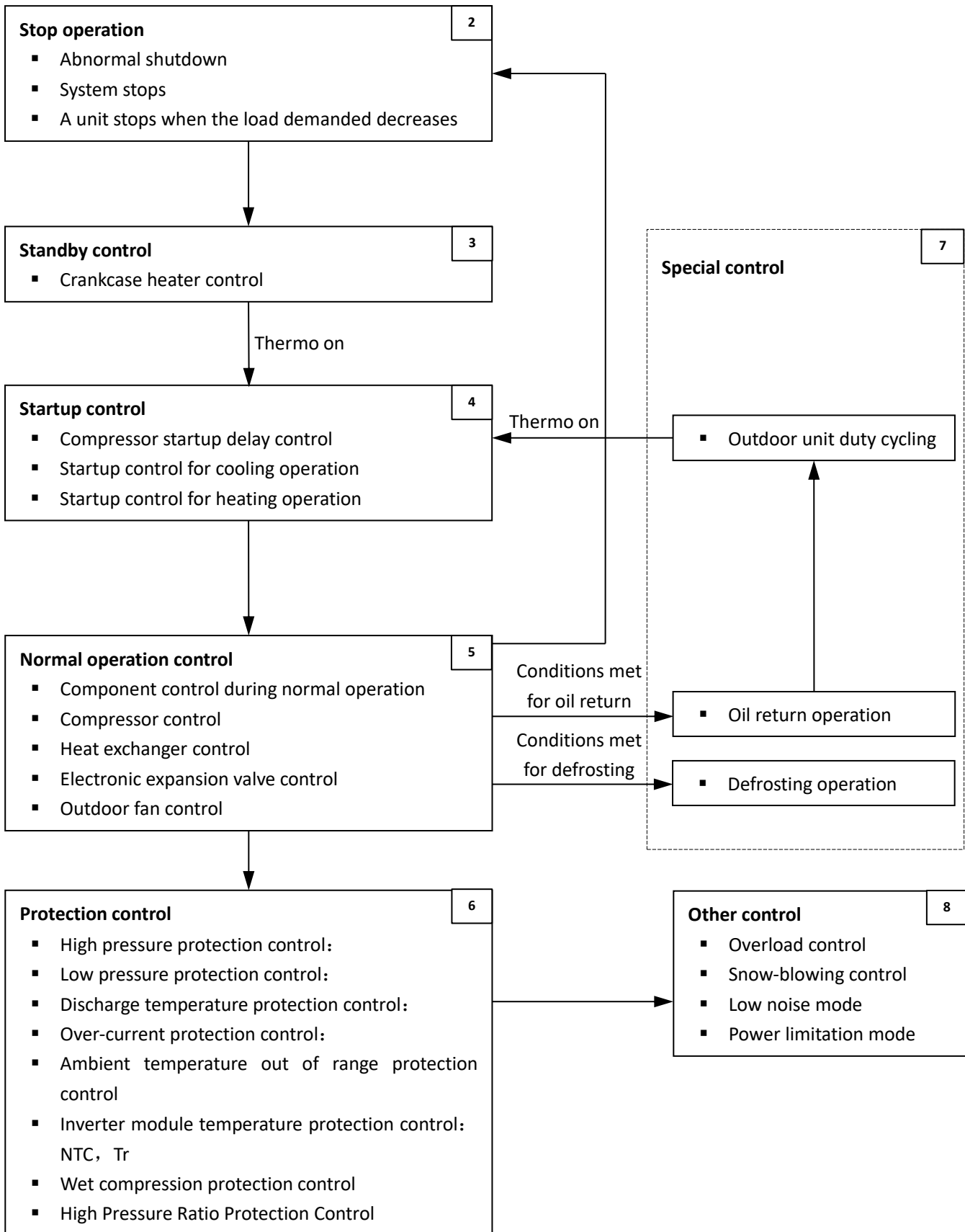

Legend
 Numbers in the top right-hand corners of boxes indicate the relevant section of text on the following pages.

2 Stop Operation

The stop operation occurs for one of the three following reasons:

1. Abnormal shutdown: in order to protect the compressors, if an abnormal state occurs, the system will make a 'stop with thermos-off' operation and an error code will be displayed on the outdoor unit digital displays.
2. The system stops when the set temperature of all indoor unit has been reached, or all indoor units has stop or error.
3. The ambient temperature is greater than 30°C and the number of cooling Thermo ON indoor unit is 0.

Table 3-2.1: Component control during stop operation

Part Name	Symbol	Stop control	
ODU	Inverter compressor	INV1	
	Inverter fan 1	FANA	
	Inverter fan 2	FANB	
	Four way valve	ST1	
	Electronic expansion valve	EEVA	cooling mode: 2880pls heating mode: 0pls
		EEVC	0pls
	Solenoid valve	SV5	ON for 140sec → OFF
		SV7	OFF
SV8A ⁽¹⁾		OFF	

Notes:

1. There is no SV8A for 20/22HP outdoor units

3 Standby Control

3.1 Crankcase Heater Control

The crankcase heater is used to prevent refrigerant from mixing with compressor oil when the compressors are stopped. The crankcase heater is controlled mainly according to the minimum of discharge temperatures.

When the minimum of discharge temperatures is above 45°C, the crankcase heater is off;

When the minimum of discharge temperatures is below 40°C, the crankcase heater turns on if one of the three following conditions is matched:

1. The first time powered on
2. In defrost operation
3. Ambient temperature < 10 °C and the compressor stops for more than 4 hours

4 Startup Control

4.1 Startup Sequence and Frequency Control in Combination Modules

During the start-up process, the control of the compressor and the heat exchange mode is uniformly judged by the master outdoor unit, and the electronic expansion valve and solenoid valve are self-judged by the valve unit according to its own sensor status.

During the start-up process, the compressor frequency is based on the displacement frequency of the 60cc compressor. After the main outdoor unit is weighted and evenly distributed to each slave unit according to the maximum frequency, each slave unit performs the displacement frequency and convert it to actual frequency.

When combinational modules are started in parallel, the master outdoor unit is started first, and each slave outdoor unit is started with a delay of 5s.

4.2 Compressor Startup Delay Control

In initial startup control, compressor startup is delayed for 3 minutes in order to let the master unit search for the indoor units' addresses.

In restart control (except in oil return operation and defrosting operation), compressor startup is delayed such that a minimum of 3 minutes and a maximum of 12 minutes has elapsed since the compressor stopped, in order to prevent frequent compressor on/off and to equalize the pressure within the refrigerant system.

4.3 Startup Control for Cooling Operation

Table 3-4.1: Component control during startup in cooling mode

Component		Wiring diagram label	Before startup ¹	Startup control				
				STEP1	STEP2	STEP3	STEP4	STEP5
ODU	Inverter compressor	INV1	0Hz	0Hz	0Hz	0Hz	Initial step for 30S, then +8Hz×Nodu / 10S. (Until it reaches (Pc-Pe)_min ≥ 0.4MPa)	adjust according to the high pressure and low pressure etc.
	Inverter fan 1	FANA	0 Step	If T4 exceeds the operating range, off 2min after the 12th gear is operated for 2min, and then off after 3 cycles at most	0 step	0 step	Start: 0 step, then adjust according to the high pressure and low pressure	PI control
	Inverter fan 2	FANB						
	Four way valve	ST1	Maintains previous position	Maintains previous position	Determined based on the initial mode of the heat exchanger			
	Electronic expansion valve	EEVA	0pls	Compressor operation: T4 < 5°C 480P EEV: 135pls; 3000P EEV: 1000pls, T4 ≥ 5°C 480P EEV: 320pls; 3000P EEV: 2000pls Compressor not operation, 0pls				
		EEVC	0pls	0pls	Compressor operation, 17pls → +8pls per 20S based on high pressure or discharge temperature. Compressor not operation, 0pls.			
	Solenoid valve	SV5	OFF	ON				
SV8A ⁽¹⁾		OFF	OFF				Compressor operation, ON Compressor not operation, OFF	
SV7		OFF → ON for 1min	OFF				ON if Pc ≥ 3.3MPa or Pe < 0.18MPa, else OFF.	
IDU	Fan	Fan	0 step	Setting speed by owners				
	Electronic expansion valve	EEV	0pls	0pls				Maintain 120pls for 2min
Ending conditions			60S	T4 ≥ -15 and T4 ≤ 55	30s	30s	(Pc-Pe)_min ≥ 0.4MPa or 60s	End if startup time arrives 5 min or the minimum superheat of discharge temperature ≥ 10°C or Tc_max > 50°C.

Notes:

1. There is no SV8A for 20/22HP outdoor units

4.4 Startup Control for Heating Operation

Table 3-4.2: Component control during startup in heating mode

Component	Wiring diagram label	Before startup	Startup control					
			STEP1	STEP2	STEP3	STEP4	STEP5	
ODU	Inverter compressor	INV1	0Hz	0Hz	0Hz	0Hz	Initial step for 30S, then +8Hz×Nodu / 10S. (Until it reaches (Pc-Pe)_min ≥ 0.3MPa)	Adjust according to the high pressure and low pressure etc.
	Inverter fan 1	FANA	0 Step	0 step	0 step	0 step	Start: 0 step, then adjust by the high pressure and low pressure	PI control
	Inverter fan 2	FANB						
	Four way valve	ST1	Maintains previous position	Maintains previous position		Determined based on the initial mode of the heat exchanger		
	Electronic expansion valve	EEVA	0pls	0pls			Evaporator, adjusted according to the difference between ambient temperature and low-pressure saturation temperature.	
		EEVC	0pls	0pls			Compressor operation, 17pls → +8pls per 20S based on high pressure or low pressure etc. Compressor not operation, 0pls.	
	Solenoid valve	SV5	OFF	ON				
		SV8A	OFF	OFF			Compressor operation, ON Compressor not operation, OFF	
SV7		OFF → ON for 1min	OFF			ON if Pc ≥ 3.3MPa or Pe < 0.18MPa, else OFF.		
IDU	Fan	Fan	0 step	Setting speed by owners (Anti-cold wind function is effective)				
	Electronic expansion valve	EEV	300pls	300pls		Maintain 300pls for 3min		
Ending conditions			60S	T4 ≤ 30	30sec	30sec	Pc-Pe > 0.3MPa or 60sec	End if startup time arrives 10 min or the minimum superheat of discharge temperature ≥ 10°C for 5min or Tc_max > 50°C.

Notes:

1. There is no SV8A for 20/22HP outdoor units

5 Normal Operation Control

5.1 Component Control during Normal Operation

Table 3-5.1: Outdoor unit component control during normal operation

Component	Wiring diagram label	Cooling	Heating
Inverter compressor	COMP(A)	PI control, High pressure protection, Low pressure protection, Discharge temperature protection, Inverter Over-current protection control, Inverter module temperature protection control, Wet compression protection control, High Pressure Ratio Protection Control	
Inverter fan 1	FANA	PI control	PI control
Inverter fan 2	FANB		
Electronic expansion valve	EEVA	Sub-cooling control	ODU superheat control, discharge pipe temperature superheat control
	EEVC	Superheat control	Superheat control
Four-way valve	ST1	OFF	ON
Solenoid valve (fast defrosting (in heating) and unloading (in cooling))	SV5	ON	OFF: Ambient temperature <12°C and heat exchanger act as evaporator and DSH ≥20°C otherwise: ON
Solenoid valve (indoor units bypass)	SV7	ON when the low pressure is too low or the high pressure is too high	
Solenoid valve (inverter compressor A/B vapor injection)	SV8A	Compressor operation, ON Compressor not operation, OFF	

Notes:

1. There is no SV8A for 20/22HP outdoor units

Table 3-5.2: Indoor unit component control during normal operation

Component	Cooling	Heating
Fan	Thermo ON unit	Remote controller setting
	Stopping unit	OFF
	Thermo OFF unit	Remote controller setting
Electronic expansion valve (EEV)	Thermo ON unit	Subcooling control
	Stopping unit	0pls / 72pls/ (according setting)
	Thermo OFF unit	56pls / 72pls/ (according setting)

5.2 Compressor Control

Cooling operation

Compressor frequency is PI controlled to keep low pressure at target temperature.

Te: Low pressure equivalent saturation temperature (°C)

Tes: Target Te value.

Tes will be decided by Te setting, if you choose Auto that means except Te setting, the Tes would be adjusted according to the ambient temperature, refrigerant pipe length, etc.

Table 3-5.7: Te setting

Setting	0	1	2	3(Default)	4	5	6	7	8
Tes(C)	-3 Fixed	0 Fixed	3 Fixed	6 Auto	7 Fixed	8 Fixed	9 Fixed	10 Fixed	11 Fixed

Heating operation

Compressor frequency is PI controlled to keep high pressure at target temperature.

Tc: High pressure equivalent saturation temperature (°C)

Tcs: Target Tc value.

Tcs will be decided by Tc setting, if you choose Auto that means except Tc setting, the Tcs would be adjusted according to the ambient temperature, refrigerant pipe length, etc.

Table 3-5.8: Tc setting

Setting	0	1	2	3	4(Default)	5	6	7
Tcs(C)	46 Fixed	40 Fixed	42 Fixed	44 Fixed	48 Auto	50 Fixed	52 Fixed	54 Fixed

Simultaneous cooling and heating operation

It controls compressor capacity to adjust Tc to target value (Tcs) and Te to target value (Tes).

5.3 Heat Exchanger Control

The mode of the outdoor units is uniformly controlled by the master outdoor unit: the master outdoor unit check status of the outdoor unit heat exchanger and sends the calculation result to each slave unit, and each slave unit control their own four-way valve, fan and EEVA.

5.4 Electronic Expansion Valve Control

5.4.1 EEVA control

The positions of electronic expansion valves EEVA are controlled in steps from 0/0 (fully closed) to 480/2880 (fully open).

5.4.1.1 Outdoor unit heat exchanger is performed via the evaporator

when outdoor temperature $\geq -8^{\circ}\text{C}$:

This function is used to exert PI control on the electronic expansion valve EEVA so that the evaporator outlet superheated degree (SH) will become constant.

$$\text{SH} = \text{T8} - \text{Te}$$

SH: Evaporator outlet superheated degree ($^{\circ}\text{C}$)

T8: Evaporator outlet temperature ($^{\circ}\text{C}$)

Te: Low pressure equivalent saturation temperature ($^{\circ}\text{C}$)

when outdoor temperature $< -10^{\circ}\text{C}$:

This function is used to exert PI control on the electronic expansion valve EEVA so that the minimum of discharge temperatures (T7C_min) will become T7CS.

$$\text{T7CS} = 3 * \text{Pr} + 12 + \text{Tc}$$

T7CS: Target discharge temperature value

T7C_min: the minimum of discharge temperatures

Tc: High pressure equivalent saturation temperature ($^{\circ}\text{C}$)

PR: pressure ratio, $\text{Pr} = (\text{Pc} + 0.11) / (\text{Pe} + 0.1)$

5.4.1.2 Outdoor unit heat exchanger is performed via the condenser

This function is used to exert PI control on the electronic expansion valve EEVA so that the condenser outlet subcooled degree (SC) will become constant.

$$\text{SC} = \text{Tc} - \text{TL}$$

SC: Condenser outlet subcooled degree ($^{\circ}\text{C}$)

TL: Condenser outlet temperature ($^{\circ}\text{C}$)

Tc: High pressure equivalent saturated

5.4.2 EEVC control

The positions of electronic expansion valves EEVC are controlled in steps from 0 (fully closed) to 480 (fully open).

In order to make the maximum use of the Microchannel heat exchanger, this function is used to exert PI control on the electronic expansion valve EEVC so that the Microchannel heat exchanger outlet superheated degree (SH) or discharge temperature (T7C1) will become constant.

$$\text{SH} = \text{T6B} - \text{T6A}$$

SH: Microchannel heat exchanger outlet superheated degree ($^{\circ}\text{C}$)

T6A: Microchannel heat exchanger inlet temperature.

T6B: Microchannel heat exchanger outlet temperature.

5.5 Outdoor Fan Control

The speed of the outdoor unit fans is adjusted in steps, as shown in Table 3-5.9

Table 3-5.9: Outdoor fan speed steps

Fan speed index	Fan speed (rpm)				Note	
	8-14HP		16-22HP		cooling	heating
	FANA	FANB	FANA	FANB	Stop operation, Startup or defrosting control[1]	Startup or defrosting control[1]
0	0	0	0	0		
1	170	170	150	170		
2	170	170	150	170		
3	170	170	150	170		
4	170	170	150	170		
5	170	170	150	170		
6	200	200	180	200		
7	230	230	210	230		
8	260	260	240	260		
9	280	280	260	280		
10	300	300	280	300		
11	330	330	310	330		
12	360	360	340	360		
13	390	390	370	390		
14	420	420	400	420		
15	460	460	440	460		
16	500	500	480	500		
17	540	540	520	540		
18	580	580	560	580		
19	620	620	600	620		
20	660	660	640	660		
21	710	710	690	710		
22	760	760	740	760		
23	810	810	790	810	18/20	18/20
24	840	840	820	840	22	22
25	880	880	840	860	8/10/12/14/16	8/10/12/14/16
26	960	960	890	910		
27	1030	1030	1000	1020		
28	1090	1090	1050	1070		
29	1160	1160	1090	1110		
30						
31						
32						
33						
34						
35						
36						
37						
38						
39						

Notes:

1. For example: When Stop operation, Startup or defrosting in cooling mode, the maximum Fan speed index that 22HP can be achieved is 24.
2. Standard step means the max. step in standard static pressure mode (0Pa default)

Table 3-5.10 Upper limit fan speed in static pressure mode
cooling

Static Pressure mode	Outdoor unit/HP							
	8	10	12	14	16	18	20	22
0Pa	24	25	25	25	25	23	23	24
20Pa	25	26	26	26	26	24	25	25
40Pa	26	27	27	27	27	25	26	26
60Pa	27	28	28	28	28	26	27	27
80Pa	28	29	29	29	29	27	28	28

Heating

Static Pressure mode	Outdoor unit/HP							
	8	10	12	14	16	18	20	22
0Pa	24	25	25	25	25	23	23	24
20Pa	25	26	26	26	26	24	25	25
40Pa	26	27	27	27	27	25	26	26
60Pa	27	28	28	28	28	26	27	27
80Pa	28	29	29	29	29	27	28	28

- Note:
- Standard models can provide 35Pa maximum external static pressure. High static pressure models can provide 80Pa maximum external static pressure.
 - If the external static pressure you needed over 35Pa, please contact us by suppliers for customized high static pressure models.

6 Protection Control

6.1 High Pressure Protection Control

This control protects the system from abnormally high pressure and protects the compressors from transient spikes in pressure.

Figure 3-6.1: High pressure protection control

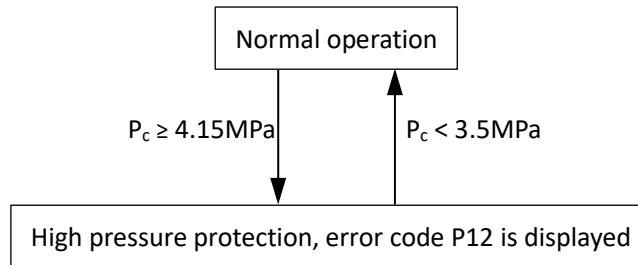

Notes:

1. Pc: Discharge pressure

6.2 Low Pressure Protection Control

This control protects the system from abnormally low pressure and protects the compressors from transient drops in pressure.

Figure 3-6.3: Low pressure protection control in cooling operation

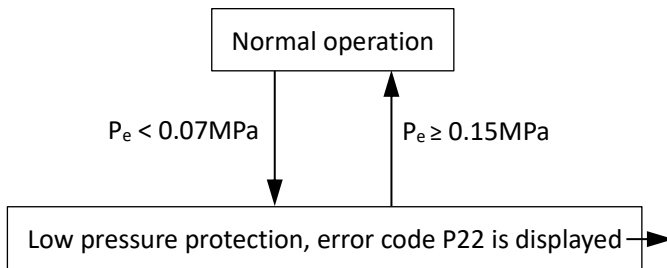

Notes:

1. Pe: Suction pressure

When P22 protection occurs 3 times in 60 minutes, the P25 error is displayed. When an P25 error occurs, a manual system restart is required before the system can resume operation.

6.3 Discharge Temperature Protection Control

This control protects the compressors from abnormally high temperatures and transient spikes in temperature. It is performed for each compressor.

Figure 3-6.5: Discharge temperature protection control

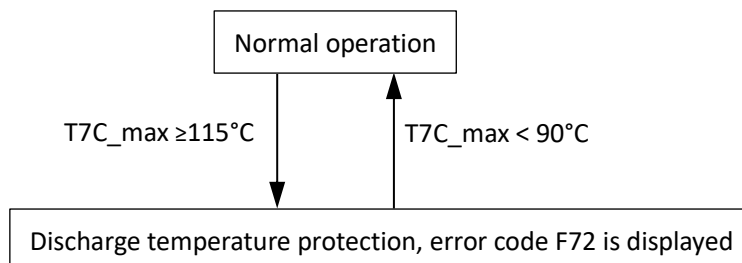

Notes:

1. T7C_max: Max temperature of compressor discharge temperatures

When the Max temperature of compressor discharge temperature rises above 115°C the system displays F72 protection and all units stop running. When F72 protection occurs 3 times in 100 minutes, the F7A error is displayed. When an F7A error occurs, a manual system restart is required before the system can resume operation.

6.4 Over-current Protection Control

Over current protection control is performed to prevent tripping due to transient inverter over-current. It protects the compressors from abnormally high currents. It is performed for each compressor.

Figure 3-6.6: Over-current protection control

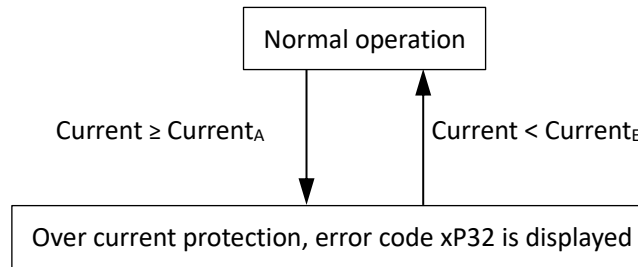

Model	8HP	10HP	12HP	14HP	16HP	18HP	20HP	22HP
Current _A	31.5	31.5	31.5	31.5	39	39	48	48
Current _E	26.5	26.5	26.5	26.5	34.5	34.5	43	43

6.5 Ambient temperature out of range protection control

When the outdoor ambient temperature rises above 30.5°C heating mode is disabled to prevent the mechanical load on compressors becoming too high and to prevent low compression ratios which can result in insufficient compressor internal oil lubrication.

Figure 3-6.7: Disable heating control

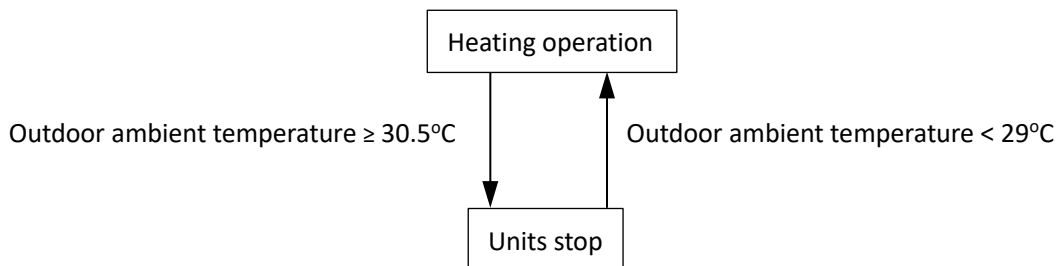

When the outdoor ambient temperature rises above 55°C or outdoor ambient temperature drops below -16°C, cooling mode is disabled to protect the compressor.

Figure 3-6.8: Disable cooling control

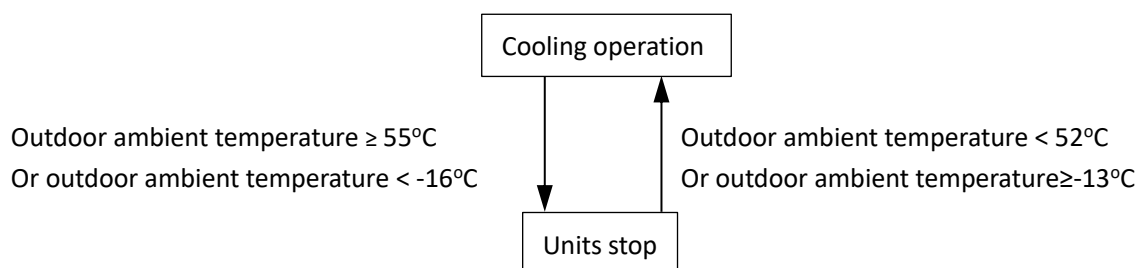

Notes:

1. If the indoor unit operates in cooling mode below -5 °C, the temperature of the indoor unit's air outlet may be lower than 0 degrees.

6.6 Inverter Module Temperature Protection Control

This control protects the compressors from abnormally high currents and protects the inverter modules from abnormally high temperatures. It is performed for each compressor and inverter module.

6.6.1 Error code F62

Figure 3-6.9: Inverter module temperature protection control

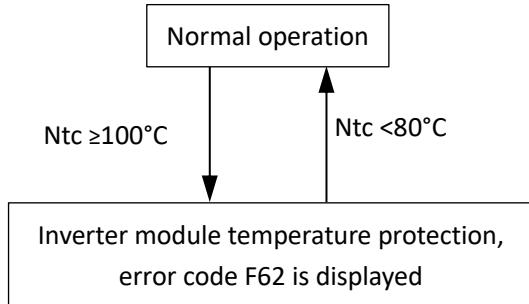

- Notes:
1. Ntc: Inverter module temperature

When F62 protection occurs 3 times in 100 minutes, the F6A error is displayed. When a F6A error occurs, a manual system restart is required before the system can resume operation.

6.6.2 Error code F63

Figure 3-6.10: Non-inductance resistors temperature protection control

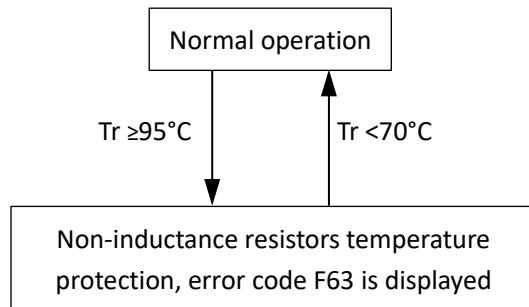

- Notes:
2. Tr: Non-inductance resistors temperature

6.7 Wet Compression Protection Control

This protection is used to prevent compressor from damaging for the long time wet compression so that it can't be lubricated well. This control is performed for each compressor.

Figure 3-6.10: Wet compression protection control

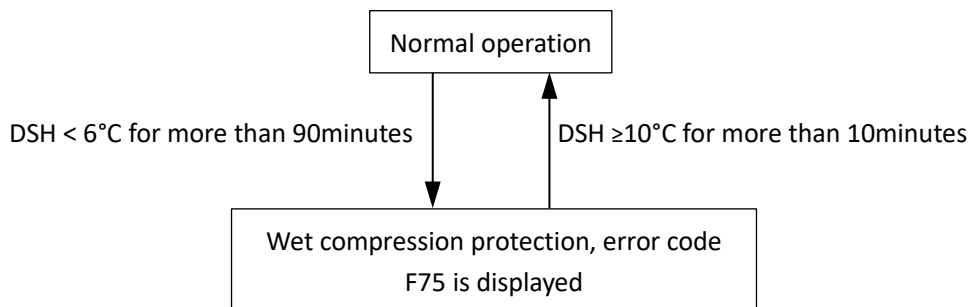

- Notes:
1. DSH: Superheat of discharge temperature

6.8 High Pressure Ratio Protection Control

This high pressure ratio protection control is used to prevent the activation of protection devices due to abnormal increase of high pressure ratio, and to protect compressors against the transient increase of high pressure ratio. It is performed for entire system.

Figure 3-6.11: High pressure ratio protection control

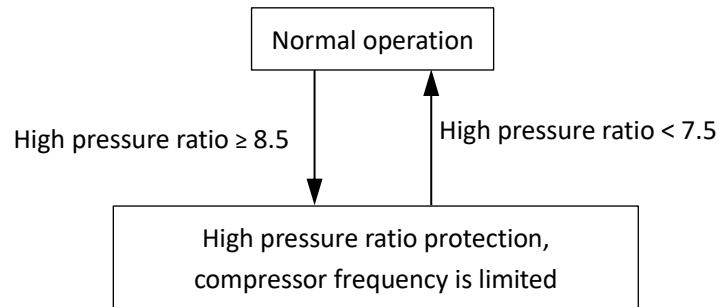

Notes:

1. P_c : Discharge pressure P_e : Suction pressure
2. Pressure Ratio = $(P_c + 0.11) / (P_e + 0.10)$

7 Special Control

7.1 Oil Return Operation

In order to prevent compressors from running out of oil, the oil return operation is conducted to recover oil that has flowed out of the compressor(s) and into the piping system. This operation is performed for all units including units that are in standby.

When the outdoor unit is running in Oil Return Operation, the digital display on outdoor main PCB will display “d0”.

7.1.1 Cooling Mode Oil Return Control

Timing of oil return operation:

- Calculated oil discharge has reached to specified level. The higher the compressor frequency step is, the more oil discharge.
- Initial cumulative compressor operating time reaches 2 hours.
- Cumulative compressor operating time reaches 8 hours.

Tables 3-7.1 and Tables 3-7.2 show component control during oil return operation in cooling mode.

Table 3-7.1: Outdoor unit control during oil return operation in cooling mode

Component		Wiring diagram label	Cooling oil return control			
			STEP1	STEP2	STEP3	STEP5
ODU	Inverter compressor A	INV1	PI control	PI control, the minimum step is as follows: 8-14HP 52Hz 16-22HP 69Hz	PI control, initial ODU number is decided	PI control
	Inverter fan 1	FANA	PI control			
	Inverter fan 2	FANB				
	Four way valve	ST1	OFF			
	Electronic expansion valve	EEVA	PI control	2880pls	PI control	
		EEVC	OFF , then 17 pls	17 pls	17 pls	PI control
	Solenoid valve	SV5	ON			
SV8A ⁽¹⁾		compressor ON:ON otherwise: OFF				
SV7		Turn ON/OFF based on the low pressure and the high pressure etc.				
Ending conditions		End if startup time arrives 180S.	End if startup time arrives 6 min or the compressor discharge volume \geq Target value for 4min.	After 20S.	After 2 min.	

Notes:

- There is no SV8A for 20/22HP outdoor units

Cooling indoor unit		500P EEV
FAN	Thermo ON unit	Keep the previous fan speed
	Thermo OFF unit	
	Stop or Fan	
Electronic expansion valve (EEV)	Thermo ON unit	Superheat control
	Thermo OFF unit	80pls
	Stop or Fan	80pls

7.1.2 Heating Oil Return Control

It's basically identical with defrosting operation, refer to 7.2 Defrosting Operation

7.2 Defrosting Operation

In order to recover heating capacity, the defrosting operation is conducted when the outdoor unit heat exchanger is performing as an evaporator. The defrosting operation is controlled according to outdoor ambient temperature, outdoor heat exchanger temperature, indoor heat exchanger temperature and outdoor units running time. When the outdoor unit is running in defrosting, the digital display on outdoor main PCB will display “df”.

Reverse Cycle Defrosting Operation

Timing of reverse cycle defrosting operation:

- $T_e < -2^{\circ}\text{C}$ and $T_4 < 20^{\circ}\text{C}$, meeting either of the points below:
 - 1) When there is an obviously drop in the temperature of outdoor unit heat exchanger outlet
 - 2) When cumulative operating time after the latest defrosting control arrives an hour
- Compulsive defrosting or oil return set manually after PI control 1min.

Table 3-7.3: Outdoor unit component control during defrosting operation

Component	Wiring diagram label	Defrosting operation control			
		Control before Defrosting	Defrosting control	Control after Defrosting	
ODU	Inverter compressor A	INV1	Reduce frequency step	8-14HP:84Hz 16-18HP: 98Hz 20-22HP: 128Hz	Reduce frequency step ,then Startup control ,then PI control
	Inverter fan 1	FANA	PI control	Initial OFF But if the high pressure is larger than 2.2MPa , turn to 10 Step or higher	Initial step then PI control
	Inverter fan 2	FANB			
	Four way valve	ST1	ON	OFF	ON
	Electronic expansion valve	EEVA/EXVB	2880pls/480pls		
		EEVC	0pls	Initial 17 step ,then +32pls or -32pls per 30S based on high pressure or discharge temperature etc.	17pls, then PI control
	Solenoid valve	SV5	ON		
SV8A		Compressor operation, ON Compressor not operation, OFF	OFF	Compressor operation, ON Compressor not operation, OFF	
SV7		Turn ON/OFF based on the low pressure and the high pressure etc.			
Ending conditions		End if $P_c - P_e < 0.4\text{MPa}$, Maximum 120S	Defrost completion condition judgment, maximum time is 9min	9min	

Notes:

1. There is no SV8A for 20/22HP outdoor units

Defrosting control time is no less than 135Sec and fulfill one of the conditions below:

- $P_c - \max \geq 3.0\text{MPa}$.
- Total defrosting control time has reached 9 minutes.
- $T_3_min > \text{Target value}$ for a certain time.

Table 3-7.4: Indoor unit component control during defrosting operation

Heating indoor unit (ODU operates cooling main operation)		500PEEV
FAN	Thermo ON unit	OFF
	Thermo OFF unit	OFF
	Stop	OFF
Electronic expansion valve (EEV)	Thermo ON unit	Within 2min: 480pls
	Thermo OFF unit	2-4min: 300pls
	Stop or error stop	After 4min: 120pls

8 Other Control

8.1 Overload control

Overload control is used to maintain comfort requirement (i.e. outlet air temperature) and keep proper system pressure.

Figure 3-8.1: Overload control

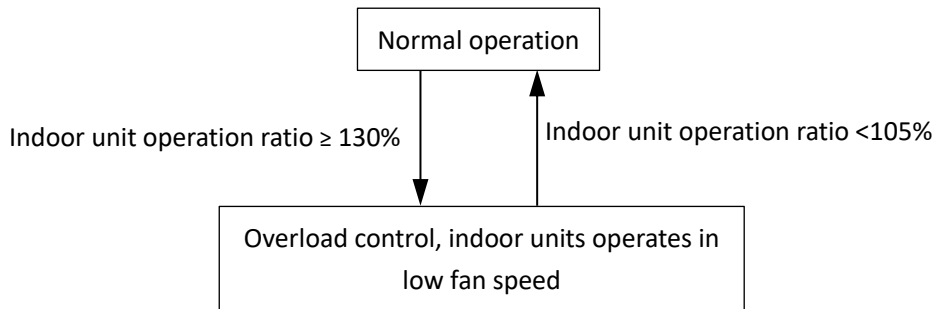

Notes:

- Indoor unit operation ratio = Indoor unit operates capacity index (in the same mode)/ outdoor unit capacity index

8.2 Vacuum control

This control is used to open solenoid valves and electronic expansion valves in the whole system. [n1-5] must be set when vacuumizing

- During the vacuum work, the high/low pressure sensor error and low pressure protection should be ineffective (Use short connectors if not).
- The four-way valve is OFF, and compressors or fans are prohibited to run.

8.3 Auto Snow-blowing Control

Auto snow-blowing control is used to prevent the fans of stopped outdoor units from destroying by heavy snow.

Timing of auto snow-blowing operation:

$T4 \leq 3^{\circ}\text{C}$ and outdoor units stops time elapse for TA.

Table 3-8.3: Snow-blowing control

Model	Fan Step	TA: Level a (Menu mode n261)	TA: Level b (Menu mode n262)	Disabled (Menu mode n260, default)
8-22HP	15	30min	15min	/

When $T4 > 3^{\circ}\text{C}$ or the outdoor unit starts operation, the time accumulated for auto snow-blowing is reset to 0.

8.4 Low Noise Mode

Low noise mode is used to decrease the noise produced by outdoor units. There are 14 kinds of low noise mode: Silent mode1~ Silent mode14. When low noise mode activating, both the fan step and compressor are limited.

Table 3-8.4: Low noise mode

ODU		Silent mode 1		Silent mode 2		Silent mode 3		Silent mode 4		Silent mode 5		Silent mode 6		Silent mode 7	
		Max. Fan step	Max. frequency step	Max. Fan step	Max. frequency step	Max. Fan step	Max. frequency step	Max. Fan step	Max. frequency step	Max. Fan step	Max. frequency step	Max. Fan step	Max. frequency step	Max. Fan step	Max. frequency step
8HP	Cooling	23	90	22	86	22	80	22	75	21	75	21	65	20	65
	Heating	23	110	22	105	21	105	21	95	21	90	20	85	19	85
10HP	Cooling	24	98	23	98	23	90	23	80	23	75	22	75	21	75
	Heating	24	126	23	120	22	105	22	95	22	90	21	85	20	85
12HP	Cooling	24	100	23	100	23	95	22	95	22	85	21	85	21	80
	Heating	25	130	24	122	23	120	22	115	21	100	21	95	21	90

14HP	Cooling	24	126	24	110	23	110	23	106	23	100	22	95	22	85
	Heating	25	126	23	120	22	115	22	100	22	95	21	95	21	90
16HP	Cooling	24	111	24	111	23	106	23	100	23	100	22	90	22	87
	Heating	25	127	23	127	22	121	22	121	22	111	21	94	21	90
18HP	Cooling	22	126	22	117	21	111	20	106	20	100	19	100	18	90
	Heating	23	137	22	137	21	127	20	127	20	111	20	94	19	90
20HP	Cooling	22	114	21	114	21	108	20	108	20	97	20	89	19	89
	Heating	22	128	22	120	21	120	21	110	20	110	20	104	20	94
22HP	Cooling	23	120	22	114	21	114	21	104	21	97	20	97	20	89
	Heating	23	130	22	130	22	120	22	110	21	110	21	104	20	94

Table 3-8.4: Low noise mode (continue)

ODU		Silent mode 8		Silent mode 9		Silent mode 10		Silent mode 11		Silent mode 12		Silent mode 13		Silent mode 14	
		Max. Fan step	Max. frequency step	Max. Fan step	Max. frequency step	Max. Fan step	Max. frequency step	Max. Fan step	Max. frequency step	Max. Fan step	Max. frequency step	Max. Fan step	Max. frequency step	Max. Fan step	Max. frequency step
8HP	Cooling	20	60	19	60	18	55	18	50	18	45	17	40	16	40
	Heating	18	80	18	70	17	70	17	65	16	65	16	60	15	55
10HP	Cooling	21	65	20	65	19	60	19	55	19	50	17	45	16	45
	Heating	19	80	19	70	18	70	18	65	17	65	16	60	16	55
12HP	Cooling	21	72	20	65	19	65	19	55	18	55	17	55	16	50
	Heating	20	85	19	75	19	70	18	70	18	62	17	60	16	55
14HP	Cooling	21	85	21	80	20	75	20	65	19	65	18	60	17	55
	Heating	20	85	19	80	19	75	18	70	18	65	18	60	17	55
16HP	Cooling	21	87	21	78	20	78	20	60	19	60	18	55	17	50
	Heating	20	90	19	86	19	82	18	82	18	75	18	72	17	60
18HP	Cooling	18	87	17	87	17	78	16	78	15	60	14	60	14	55
	Heating	18	90	18	86	17	82	16	82	16	75	15	72	15	60
20HP	Cooling	19	79	19	71	17	71	17	63	17	54	16	54	15	44
	Heating	19	94	18	84	17	84	17	77	16	69	16	63	15	59
22HP	Cooling	19	89	19	81	18	71	17	71	17	63	16	63	16	54
	Heating	20	94	19	92	18	84	17	77	17	69	16	63	15	59

8.5 Power Limitation Mode

The energy saving mode is used to limit the system power. It can be used to limit the line selection current or to reduce the peak current.

Table 3-8.5: Power limitation mode

Power limitation mode setting	Power limitation mode level	Correction factor
n23 40 ~n23 100	n23 40	40%
	n23 41	41%
	n23 42	42%
	~	
	n23 98	98%
	n23 99	99%
	n23 100 (Default)	100%

Part 4

Field Settings

1. Overview	49
2. Digital display and button settings	49
3. System Parameter Check	59

1. Overview

This chapter describes how the system configuration can be implemented once the installation is completed, and other relevant information.

It contains the following information:

- Implement field settings
- Using the Check function

i INFORMATION

The installation personnel should read this chapter.

2. Digital display and button settings

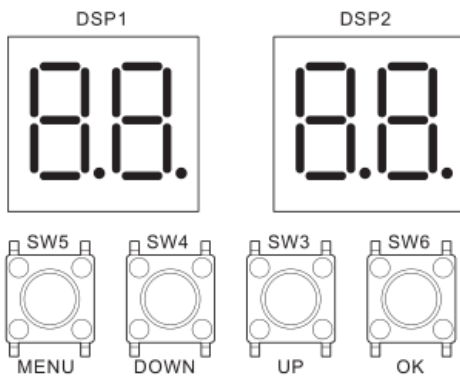

2.1 Digital display output

Table 4-2.1: Digital display output

Outdoor unit state	Parameters displayed on DSP1	Parameters displayed on DSP2
Standby	The address of outdoor unit	The number of indoor units in communication with the outdoor units
Normal operation	---	Running speed of the compressor in rotations per second
Error or protection	Placeholder and error or protection cod	
In menu mode	Display menu mode code	
System check	Display system check code	

2.2 Function of buttons SW3 to SW6

Table 4-2.2 Function of buttons SW3 to SW6

Button	Function
SW3(UP)	In menu mode: previous and next buttons for menu modes. Not in menu mode: previous and next buttons for system check information.
SW4(DOWN)	
SW5(MENU)	Enter / exit menu mode.
SW6(OK)	Confirm to enter specified menu mode.

2.3 Menu mode

Only master unit has the full menu functions, slave units only have error codes check and cleaning functions.

1. Long press SW5 "MENU" button for 5 seconds to enter menu mode, and the digital display displays "n0".
2. Press SW3 / SW4 "UP / DOWN" button to select the first level menu "n0" to "n9" or "nc".
3. Press SW6 "OK" button to enter specified first level menu, for example, enter "n2" mode.
4. Press SW3 / SW4 "UP / DOWN" button to select the second level menu from "n20" to "n28".
5. Press SW6 "OK" button to enter specified second level menu, for example, enter "n22" mode.
6. Press SW3 / SW4 "UP / DOWN" button to select the parameter value, for example, from "0" to "4".
7. Press SW6 "OK" button to confirm the parameter.

CAUTION

- Operate the switches and push buttons with an insulated stick (such as a closed ball-point pen) to avoid touching of live parts.

Menu mode selection flowchart:

Figure 4-2.1 Menu mode selection flowchart:

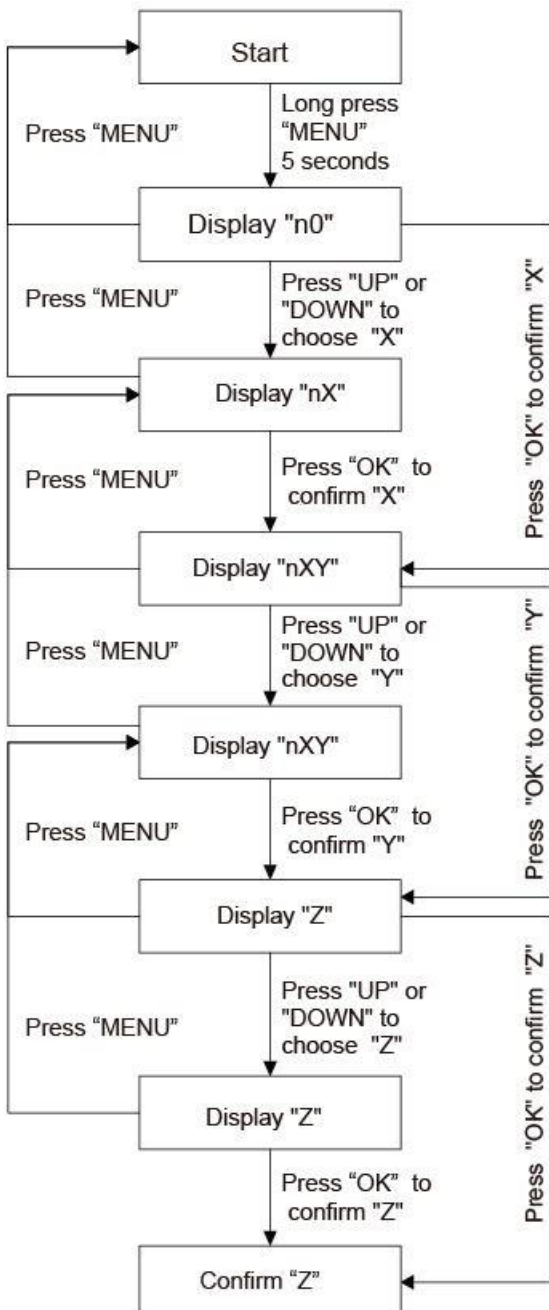

Menu mode function:
Table 4-2.3 Menu mode function:

First level menu	Second level menu	Specified menu mode	Description	Default
n0 (Information query)	0 (History error)	0	Query History error (last ten error codes)	-
		1	Cleaning history error	
	1 (address)	0	Query Indoor unit's address	
		2	Query the address of Indoor unit in power-off condition	
	2	1	Driver's version(compressor and fan displayed in turn)	
4	-	Accumulated running time of compressor		
n1 (Installation and commissioning)	0	-	Shield C26 and C28 error in 3 hours	-
	1[1] (System test)	0	Cooling Test	
		1	Heating Test	
		2	Test running	
		4	System refrigerant quantity detection	
	2[1] (Refrigerant recovery)	0	Recycle Refrigerant to outdoor unit	
		1	Recycle Refrigerant to indoor unit	
		2	Balance system refrigerant	
	3[1] (Refrigerant charge)	0	Manual refrigerant charge	
		1	Auto refrigerant charge(Customized)	
	4	-	Exit special mode (System test; Refrigerant recovery; Refrigerant charge; Vacuum mode)	
5	-	Vacuum mode[2]		
6	-	Setting the VIP IDU address (Default:No.63)		
n2 (Mode setting)	0[1] (Priority mode)	0	Automatic priority mode	√
		1	Cooling priority mode	-
		2	VIP indoor unit voting priority mode	
		3	In response to heating mode only	
		4	In response to cooling mode only	
		5	Heating priority mode	
		6	Change over	
		7	Voting priority mode	
		8	First on priority mode	
		9	Capability requirements priority mode	
	1 (Silent mode)	0	Non silent mode	
		1	Silent mode 1	-
		2	Silent mode 2	
		3	Silent mode 3	
		4	Silent mode 4	
		5	Silent mode 5	
		6	Silent mode 6	
7	Silent mode 7			

Notes:

- For details of mode, refer to 2.4 *Special mode introduction*
- This setting must be performed when vacuumizing.

Table 4-2.3 Menu mode function(continue)

First level menu	Second level menu	Specified menu mode	Description	Default
n2 (Mode setting)	1 (Silent mode)	8	Silent mode 8	-
		9	Silent mode 9	
		A	Silent mode 10	
		b	Silent mode 11	
		C	Silent mode 12	
		d	Silent mode 13	
		E	Silent mode 14	
	2 (static pressure)	0	0Pa static pressure	√
		1	20Pa static pressure	-
		2	40Pa static pressure(Customized)	
		3	60Pa static pressure(Customized)	
		4	80Pa static pressure(Customized)	
	3 (Power limitation mode)	40	Power limitation mode, Maximum current =MCA * setting value	-
		41		
		42		
		~		
		98		
		99		
	4 (Meta)	0	Meta function unavailable	-
		1	Meta function available	√
	5 (°C or °F)	0	Celsius will be enable on display	√
		1	Fahrenheit will be enable on display	-
	6[1] (Auto snow-blowing)	0	Auto snow-blowing function unavailable	√
		1	Auto snow-blowing function available, mode 1	-
		2	Auto snow-blowing function available, mode 2	
	7[2] (Auto dust-clean)	0	Auto dust-clean function unavailable	√
		1	Auto dust-clean function available	-
	8 (Dry contact)	0	Dry contact closing effective	√
		1	Dry contact opening effective	-
	9[3] (Automatic priority mode)	0	Mode Switching temperature:10°C	√
		1	Mode Switching temperature:16°C	-
		2	Mode Switching temperature:21°C	
	n3 (Installation parameters)	2[4] (Level difference)	0	0m level difference between indoor unit and outdoor unit
1			20m level difference between indoor unit and outdoor unit	-
2			40m level difference between indoor unit and outdoor unit	
3			50m level difference between indoor unit and outdoor unit	

Notes:

1. When the outdoor unit is in standby, the fan will turn on to clear the snow on the fan blade, and the effect of mode 2 is better than that of mode 1.
2. When the outdoor unit is in standby, the fan will start to remove the dust of heat exchanger.
3. For details of mode, refer to 2.4 *Special mode introduction*
4. If the horizontal height of the outdoor unit is higher than that of the indoor units, it needs to be set to improve the reliability of the system.

Table 4-2.3 Menu mode function(continue)

n3 (Installation parameters)	7 (Ambient temperature)	0	Enable Internal ambient temperature sensor(T4)	√
		1	Enable External ambient temperature sensor(T10-Optional)	-
	8	0	Reserved	-
		1	Reserved	√
	E	0	Reserved	-
		1	Reserved	√
n4 (address)	0	-	Set address of Outdoor unit	-
	1	-	Set Network address of Outdoor unit	0
	2	-	Set number of indoor units	1
	4	0	Auto addressing (indoor and outdoor units address)	-
		1	Clear address (indoor and outdoor units address, network address)	
	5 (communication protocol)	0	V8 communication protocol (RS-485 (P Q) communication)	√
		1	Non-V8 communication protocol (RS-485 (P Q E) communication)	-
		2	HyperLink (M1 M2) communication -IDUs uniform power supplied	
		3	HyperLink (M1 M2) communication -IDUs separate power supplied	
	n5[1] (Backup)	0 (Fan, compressor and outdoor unit)	0	Fan backup unavailable
1			Fan backup available[2]	√
1 (Sensors)		0	Sensors backup running unavailable	-
		1	Sensors backup running available (Manual)	√
		2	Sensors backup running available (Automatic)	-
2 (Backup operation time)		0	Backup operation time setting(1 day)	-
		1	Backup operation time setting(2 days)	
		2	Backup operation time setting(3 days)	
		3	Backup operation time setting(4 days)	
		4	Backup operation time setting(5 days)	
		5	Backup operation time setting(6 days)	
		6	Backup operation time setting(7 days)	√
n6 (evaporation and condensation temperature)		0 (target evaporation temperature of the indoor unit)	0	-3°C
	1		0°C	
	2		3°C	
	3		6°C	√
	4		7°C	-
	5		8°C	
	6		9°C	
	7		10°C	
	8		11°C	

Notes:

1. Only one compressor backup, one fan backup or one sensor backup can be started at the same time

Table 4-2.3 Menu mode function(continue)

First level menu	Second level menu	Specified menu mode	Description	Default
n6 (evaporation and condensation temperature)	2 (target condensation temperature of the indoor unit)	0	41°C	-
		1	42°C	
		2	43°C	
		3	44°C	
		4	45°C	
		5	46°C	
		6	48°C	
		7	51°C	-
n8	7 (Low noise defrosting)	0	Low noise defrosting mode unavailable	√
		1	Low noise defrosting mode available	-
n9	1	0	Reserved	-
		1	Reserved	-
		2	Reserved	√
		3	Reserved	-
	5	-	Release central controller emergency stop statue	-
	7	0	Digital electricity meter	√
		1	Pulse electricity meter	-
nc[1] (Dry contact function)	0	0	Dry contact 1 function selection (Force cooling only)	-
		1	Dry contact 1 function selection (Force heating only)	
		2	Dry contact 1 function selection (Force incapacity requirements)	
		3	Dry contact 1 function selection (Force stop)	√
	1	0	Dry contact 2 function selection (Force cooling only)	-
		1	Dry contact 2 function selection (Force heating only)	
		2	Dry contact 2 function selection (Force incapacity requirements)	
		3	Dry contact 2 function selection (Force stop)	√
	2	0	Dry contact 3 function selection (Operation signal)	-
		1	Dry contact 3 function selection (Alarm signal)	√
		2	Dry contact 3 function selection (Compressor running signal)	-
		3	Dry contact 3 function selection (Defrosting signal)	
		4	Dry contact 3 function selection (Refrigerant leakage signal)	

Notes:

- Using with setting [n2-8-0] or [n2-8-1].

2.4 Special mode introduction

2.4.1 Priority mode setting

Priority mode can only be set on the master unit. When an indoor unit is in mode conflict with the outdoor units the unit displays the mode conflict error. The digital display on indoor main PCB will display error code E0.

There are ten priority mode options:

1. **Auto priority mode (default):** In auto priority mode, the outdoor unit will operate in heating priority mode or cooling priority mode according to the outdoor ambient temperature.

In this function, the mode switching temperature is **A**, and A can be set by menu [n2-9-0/1/2]

- a) When the outdoor ambient temperature is below **(A-3)°C**, the outdoor units run in heating priority mode. The heating priority mode does not change until the outdoor ambient temperature is above **A°C**.
- b) When the outdoor ambient temperature is above **A°C**, the outdoor units run in cooling priority mode. The cooling priority mode does not change until the outdoor ambient temperature is below **(A-3)°C**.
- c) When the outdoor units restart under the outdoor ambient between **(A-3)°C** and **A°C**, the outdoor units run the same priority as before the last stop.
- d) When the outdoor unit is initial startup under outdoor ambient temperature between **(A-3)°C** and **A°C**, the outdoor units run in heating priority mode.

Figure 4-2.2: Auto priority mode control

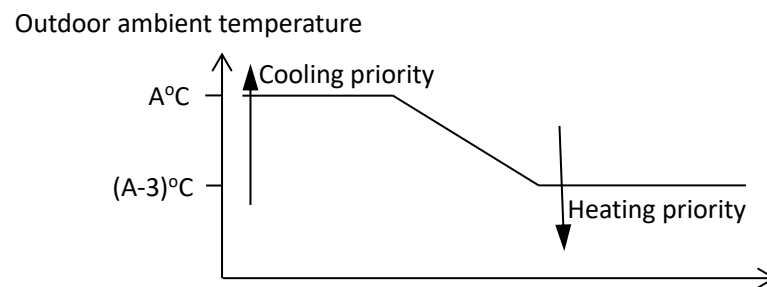

2. **Cooling priority mode:**

- a) **During heating operation:** If an indoor unit requests cooling, the outdoor units stop and then restart in cooling mode after 5 minutes. Indoor units requesting cooling then start in cooling mode and indoor units requesting heating display the mode conflict error.
- b) **During cooling operation:** If an indoor unit requests heating, the outdoor units ignore the request and continue to run in cooling mode. The indoor unit requesting heating displays the mode conflict error. If all the indoor units requesting cooling are later turned off and one or more indoor units are still requesting heating, the outdoor units restart in heating mode after 5 minutes and any indoor units requesting heating then start in heating mode.

3. **Heating priority mode:**

- a) **During cooling operation:** If an indoor unit requests heating, the outdoor units stop and then restart in heating mode after 5 minutes. Indoor units requesting heating then start in heating mode and indoor units requesting cooling display the mode conflict error.
- b) **During heating operation:** If an indoor unit requests cooling, the outdoor units ignore the request and continue to run in heating mode. The indoor unit requesting cooling displays the mode conflict error. If all the indoor units requesting heating are later turned off and one or more indoor units are still requesting cooling, the outdoor units restart in cooling mode after 5 minutes and any indoor units requesting cooling then start in cooling mode.

4. **VIP priority mode:** The default VIP address is 63, the VIP address also can be changed through menu mode "n1-6".

In VIP priority mode, if the VIP indoor unit is operating, the outdoor units will operate in the mode of the VIP indoor unit. In the meantime indoor units, which are in a mode different to that of the VIP unit, will display the mode conflict error (E0).

5. **Changeover mode:** Before using this mode, you need to set the VIP indoor unit address. The default VIP address is 63, the VIP address also can be changed through menu mode“n1-6”.
In changeover mode, if the VIP indoor unit is operating, the outdoor units will operate in the mode of the VIP indoor unit. The other units in the system will follow the mode of the VIP indoor unit, so there will be no mode conflict.
In the changeover mode, the VIP indoor unit can select the auto mode, so that the system can run the auto mode, and other indoor unit can follow the VIP indoor unit without mode conflict.
6. **Voting priority mode:** In voting priority mode, the outdoor units operate in whichever of heating and cooling modes is being requested by the larger number of indoor units.
7. **First on priority mode:** The outdoor units will operate in the mode of the indoor unit (first open in the system). In the meantime indoor units, which are in a mode different to that of the first open unit, will display the mode conflict error (E0).
8. **Capability requirements priority mode:** In Capability requirements priority mode, the outdoor units operate in whichever of heating and cooling modes is being requested by the larger Capability requirements of indoor units.
9. **Heating only mode:** The outdoor units only operate in heating mode. Indoor units requesting heating operate in heating mode. Indoor units requesting cooling or in fan only mode display the mode conflict error.
10. **Cooling only mode:** The outdoor units only operate in cooling mode. Indoor units requesting cooling operate in cooling mode; indoor units in fan only mode operate in fan only mode. Indoor units requesting heating display the mode conflict error.

2.4.2 System test

1. Cooling Test/ Heating Test

After the outdoor unit enter this mode, all indoor units in the system are forced to run cooling or heating mode, which is consistent with the normal operation.

How to exit test:

- a) Press and hold the OK key for 5s to exit
- b) Automatic exit in case of failure during operation
- c) Automatic exit after 240 minutes of test.

2. Test running

This operation checks and determines the following items:

- a) Check if there is a wiring error (with the communication check of the indoor unit)
- b) Check if the stop valve is open
- c) Determine the length of the pipe

There are 8 steps in the test running, and the specific process is as follow:

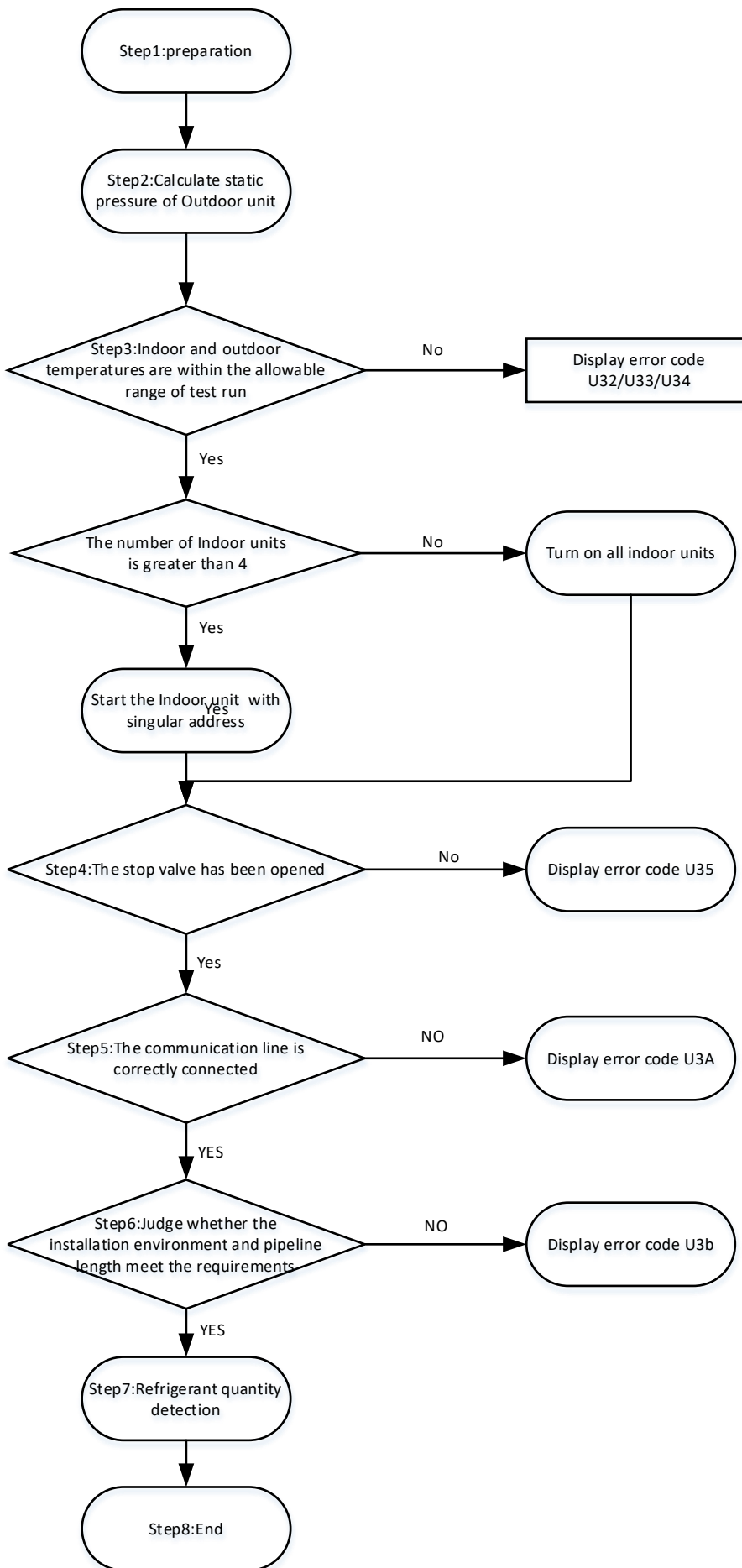

Notes: After the fault is removed, long press the OK key for 5 seconds to restart the test run.

3. System refrigerant quantity detection

After entering this mode, the system will automatically run and finally output the diagnostic results of the system refrigerant quantity.

Diagnostic results:

- a) Normal: Digital display "d34"
- b) Significantly excessive: Digital display "d32"
- c) Excessive: Digital display "d33"
- d) Insufficient: Digital display "d35"
- e) Significantly insufficient: Digital display "d36"
- f) No result- The system operation conditions do not meet the functional requirements: Digital display "d31"

2.4.3 Refrigerant recovery

In this mode, the operation process is as follows:

a) Refrigerant recovery to outdoor unit:

- (1) First, close the liquid pipe stop valve and keep the gas pipe stop valve open;
- (2) Menu setting [n1-2-0], the system enters the refrigerant recovery mode, when the digital display alternately "End" and the system low pressure value, close the gas pipe stop valve.

b) Refrigerant recovery to indoor unit:

- (1) First, manually close the liquid pipe stop valve and keep the gas pipe stop valve open;
- (2) Menu setting [n1-2-1], the system enters the refrigerant recovery mode, when the digital display alternately displays "End" and the system low pressure value, close the gas pipe stop valve.

c) Balance system refrigerant:

- (1) Ensure that both the gas pipe stop valve and the liquid pipe stop valve are open.
- (2) Menu setting [n1-2-2], the system enters the Balance system refrigerant mode.

2.4.4 Refrigerant charge

a) Manual refrigerant charge:

- (1) Without customized refrigerant charging valve (EEVE)

Charge the refrigerant through the stop valve

- (2) With customized refrigerant charging valve (EEVE)

Menu setting [n1-3-0], refrigerant charging valve (EEVE) will open, you can charge the refrigerant through EEVE.

b) Auto refrigerant charge :

The refrigerant charging valve (EEVE) must be customized to use this function.

Menu setting [n1-3-1], refrigerant charging valve (EEVE) will open, the system will automatically charge refrigerant through EEVE. When refrigerant charging is completed, the digital displays "End" and EEVE will close.

3. System Parameter Check

3.1 UP / DOWN system check button

Before pressing UP or DOWN button, allow the system to operate steadily for more than an hour. On pressing UP or DOWN button, the parameters listed in below table will be displayed in sequence.

Table 4-3.1 system check list:

DSP1 content	Parameters displayed on DSP2	Remarks
----	"Standby (ODU address + IDU quantity) /frequency/special status"	
0.--	Outdoor unit address	Master unit: 0; slave units: 1, 2 255 represents invalid address
1.--	Outdoor unit capacity	Actual value = value displayed (HP)
2.--	Number of outdoor units	1~4 ⁽¹⁾
3.--	Number of indoor units (set by master unit)	1~64 ⁽¹⁾
4.--	Total capacity of outdoor unit	Only available for master unit ⁽²⁾
5.--	Target frequency of this ODU	Displacement frequency ⁽³⁾
6.--	Target frequency of ODU system	Target frequency= value displayed ×10
7.--	Inverter compressor A actual frequency(Hz)	Actual value = value displayed
8.--	Reserved	-
9.--	Operating mode	0: OFF
		2: Cooling
		3: Heating
10.--	Fan A speed index (rpm)	Actual value = value displayed
11.--	Fan B speed index (rpm)	Actual value = value displayed
12.--	Indoor heat exchanger pipe (T2) average temperature (°C)	Actual value = value displayed ⁽¹⁾
13.--	Indoor heat exchanger pipe (T2B) average temperature (°C)	Actual value = value displayed ⁽¹⁾
14.--	Main heat exchanger pipe (T3) temperature (°C)	Actual value = value displayed
15.--	Outdoor ambient (T4) temperature (°C)	Actual value = value displayed
16.--	Liquid pipe (T5) temperature (°C)	Actual value = value displayed
17.--	Microchannel heat exchanger inlet pipe (T6A) temperature (°C)	Actual value = value displayed
18.--	Microchannel heat exchanger outlet pipe (T6B) temperature (°C)	Actual value = value displayed
19.--	Inverter compressor A discharge (T7C1)temperature (°C)	Actual value = value displayed
20.--	Reserved	
21.--	Inverter compressor A suction (T71) temperature (°C)	Actual value = value displayed
22.--	Reserved	
23.--	(T8) temperature (°C)	Actual value = value displayed
24.--	Inverter module heatsink (Ntc)temperature (°C)	Actual value = value displayed
25.--	heat recovery unit's (T9) temperature (°C)(Reserved)	Actual value = value displayed
26.--	Outdoor Heat exchanger liquid (TL)temperature (°C)	Actual value = value displayed
27.--	Discharge superheat degree (°C)	Actual value = value displayed

DSP1 content	Parameters displayed on DSP2	Remarks
28.--	Primary current(A)	Actual value = value displayed /10
29.--	Inverter compressor A current (A)	Actual value = value displayed /10
30.--	Reserved	-
31.--	EXVA position	Actual value = value displayed × 24
32.--	Reserved	-
33.--	EEVC position	Actual value = value displayed × 4
34.--	EEVE position	Actual value = value displayed × 4
35.--	Compressor discharge pressure (MPa)	Actual value = value displayed × 0.01
36.--	Compressor suction pressure(MPa)	Actual value = value displayed × 0.01
37.--	Quantity of indoor units online	Actual value = value displayed ⁽¹⁾
38.--	Quantity of indoor units online	Actual value = value displayed ⁽¹⁾
39.--	Heat exchanger status(Outdoor unit)	【0】 OFF
		【1】 C1:Cooling mode
		【2】 D1: Disabled(Cooling mode) ⁽⁴⁾
		【3】 D2:Compressor OFF(Cooling mode)
		【4】 E1:Heating mode
		【5】 F1: Disabled(Heating mode) ⁽⁴⁾
40.--	Special state	【6】 F2:Compressor OFF(Heating mode)
		【0】 No special mode
		【1】 Oil return
		【2】 Defrost
		【3】 Start-up
		【4】 Stop
41.--	Silent mode	【5】 Quick check
		【6】 Self cleaning
		0~14 ,14 represents the most silent
		【0】 0Pa
		【1】 20Pa
42.--	Static pressure mode	【2】 40Pa
		【3】 60Pa
		【4】 80Pa
		43.--
44.--	Tcs (Target condensing temperature) (°C)	Actual value = value displayed ⁽⁵⁾
45.--	DC Voltage (V)	Actual value = value displayed
46.--	AC Voltage (V)	Actual value = value displayed
47.--	Quantity of cooling mode IDUs	Actual value = value displayed
48.--	Quantity of heating mode IDUs	Actual value = value displayed
49.--	Capacity of cooling mode IDUs (HP)	Actual value = value displayed ⁽¹⁾
50.--	Capacity of heating mode IDUs (HP)	Actual value = value displayed ⁽¹⁾

DSP1 content	Parameters displayed on DSP2	Remarks
51.--	Refrigerant volume judgment ⁽¹⁾	【0】 :No result
		【1】 :Significantly insufficient
		【2】 :insufficient
		【3】 :Normal
		【4】 :excessive
		【5】 :Significantly excessive
52.--	Dirty blockage rate (outdoor heat exchanger)	0~10, 10 represents the worst
53.--	Fan historical error	
54.--	Software version	
55.--	Last error or protection code	
56.--	Reserved	
57.--	Reserved	
58.--	Reserved	
--		

Notes:

- (1) Only available for master unit (Combined system).
- (2) Only available for master unit (Combined system), 0 displayed on slave units has no sense.
- (3) Need to convert to current compressor output volume, example: compressor output volume is 98, Target frequency =Actual frequency * 98 / 60.
- (4) Only available for Heat recovery unit
- (5) Te: Low pressure equivalent saturation temperature (°C) Tes: Target Te value.
Tc: High pressure equivalent saturation temperature (°C) Tcs: Target Tc value.

Part 5

Electrical Components and Wiring Diagrams

1. Outdoor Unit Electric Control Box Layout.....	63
2. Outdoor Unit Main Control Board.....	64
3. Compressor & Fan drive board.....	68
4. Wiring Diagrams	74

1. Outdoor Unit Electric Control Box Layout

Figure 5-1.1: 8-22HP top layer of electric control box

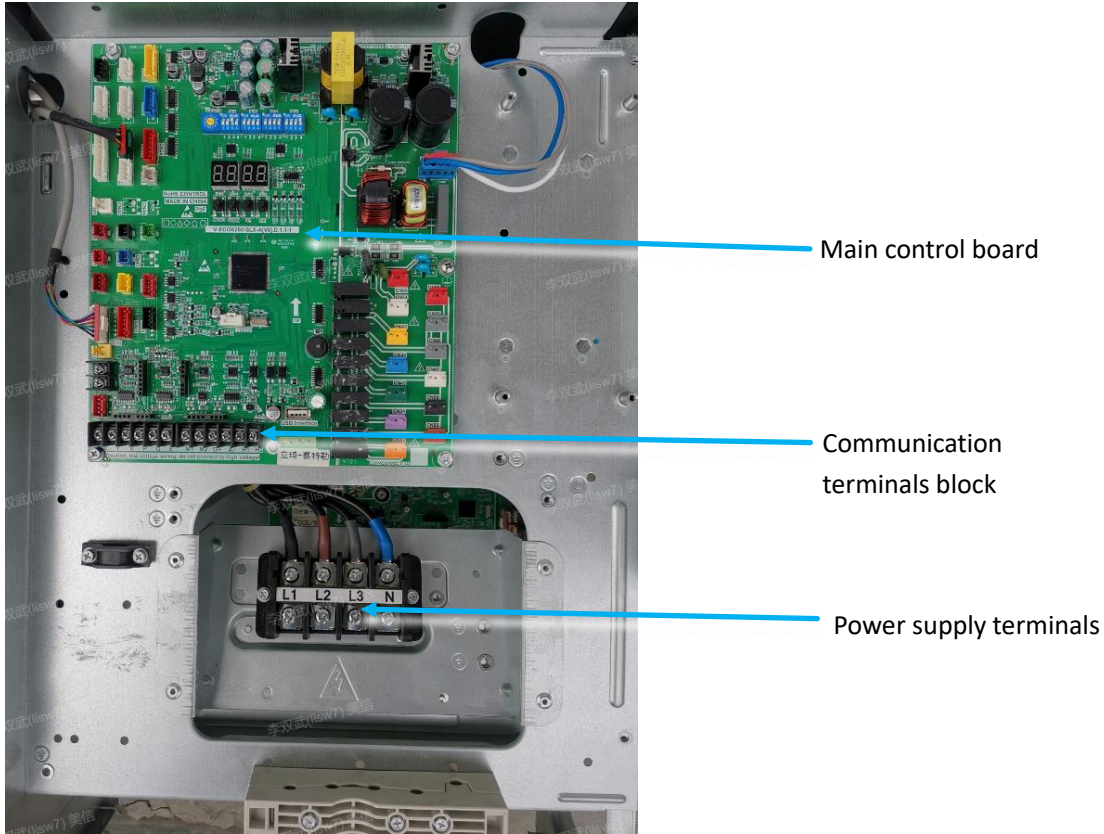
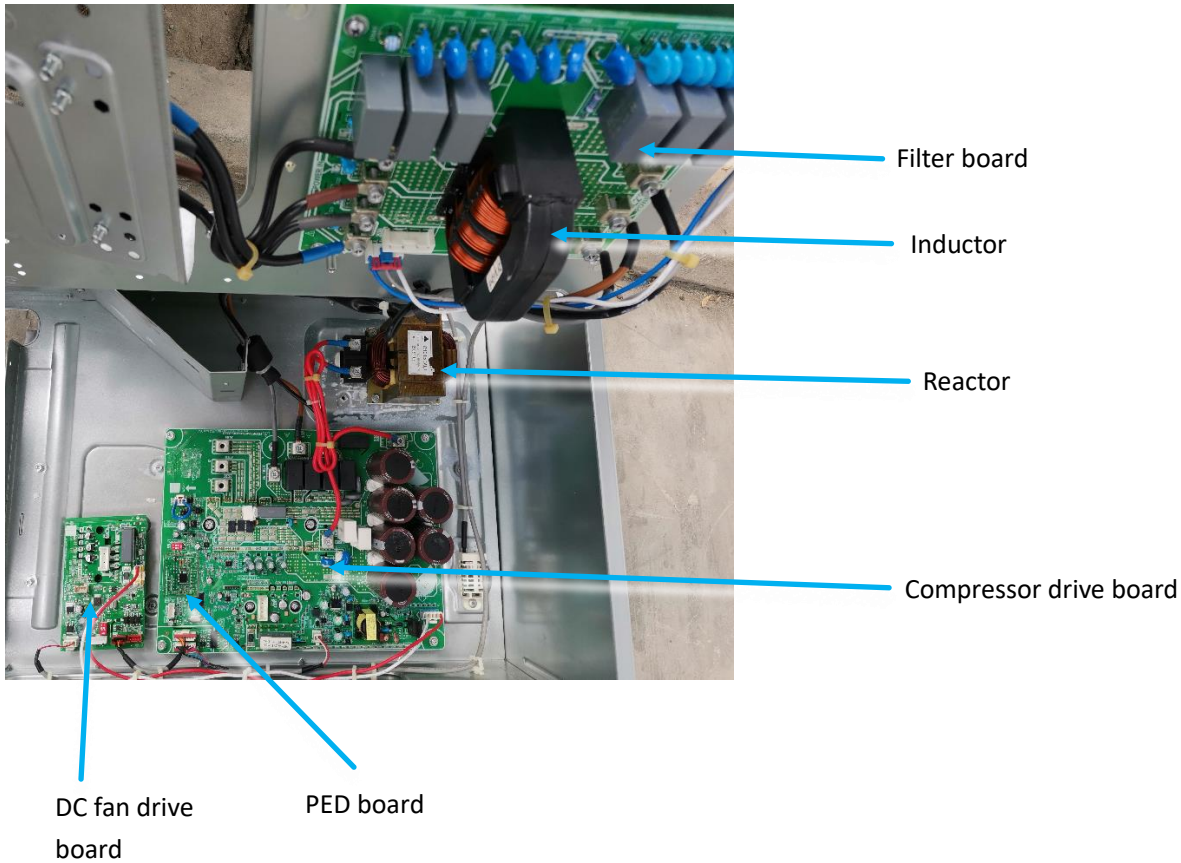

Figure 5-1.2: 8-22HP bottom layer of electric control box



2. Outdoor Unit Main Control Board

2.1 Outdoor unit main Control Board ports

Figure 5-2.1: Outdoor unit main Control Board ports¹

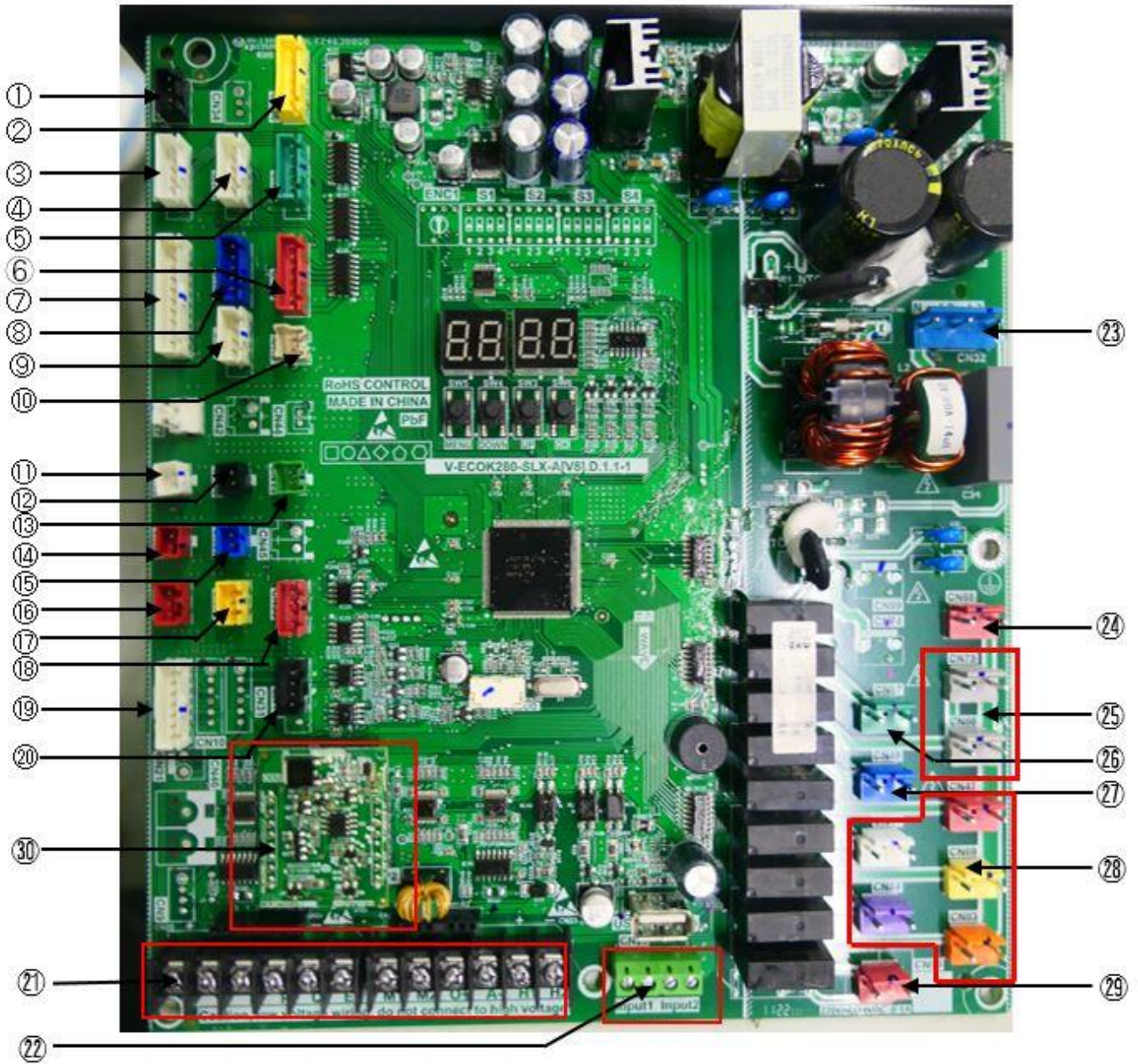

Notes:

Label descriptions are given in *Table 5-2.1: Main Control Board port*

Table 5-2.1: Main Control Board port

Label in Figure 5-2.1	Port code	Content	Port voltage
1	CN82	Reserved	5Vdc
2	CN36	Reserved	3.3Vdc
3	CN70	EEVA drive port	12Vdc
4	CN71	EEVB drive port(Reserved)	12Vdc
5	CN72	EEVC drive port	12Vdc
6	CN73	EXVE drive port	12Vdc
7	CN4	Microchannel heat exchanger inlet temperature sensor(T6A) /Liquid pipe inlet temperature sensor(T5) /Microchannel heat exchanger outlet temperature sensor(T6B) /Suction temperature sensor 1 (T71) /Discharge temperature sensor 1 (T7C1) (From top to bottom)	3.3Vdc
8	CN35	Electric control box chamber Temperature & Humidity sensor(Tb)	3.3Vdc
9	CN8	Condenser inlet temperature sensor(T8)/Main exchanger pipe temperature sensor(T3) (From top to bottom)	3.3Vdc
10	CN3	Condenser outlet temperature sensor(TL)	3.3Vdc
11	CN16	Gas pipe temperature sensor(Tg)	3.3Vdc
12	CN38	Reserved	3.3Vdc
13	CN11	Reserved	3.3Vdc
14	CN37	Reserved	3.3Vdc
15	CN30	Outdoor ambient temperature sensor(T4)	3.3Vdc
16	CN41	Low pressure sensor	5Vdc
17	CN40	High pressure sensor	5Vdc
18	CN33	Expanded communication port	12Vdc
19	CN26	Communication port to Compressor & Fan Drive Board	5Vdc+12Vdc
20	CN14	Communication port to data transfer module	12Vdc
21	CN22/CN23	Communication port	0-5V DC (varying)
22	CN28	Emergency stop port	0V or Open
23	CN32	Power input of main board	176Vac~264Vac
24	CN68	Reserved	176Vac~264Vac
25	CN75/CN66	Power supply to compressor crankcase heater	176Vac~264Vac
26	CN67	Solenoid valve drive ports (Reserved)	176Vac~264Vac
27	CN48	Four-way valve drive ports(ST1)	176Vac~264Vac
28	CN47 /CN49/CN69 /CN84/CN83	Solenoid valve drive ports CN47-SV6 ; CN49-SV5 ; CN69-SV7 ; CN84-SV8A; CN83-SV8B	176Vac~264Vac
29	CN93	Dry contact output	0V or Open
30	-	HyperLink board	-

2.2 Outdoor unit main Control Board components

2.2.1 Layout

Figure 5-2.2: Outdoor unit main Control Board components

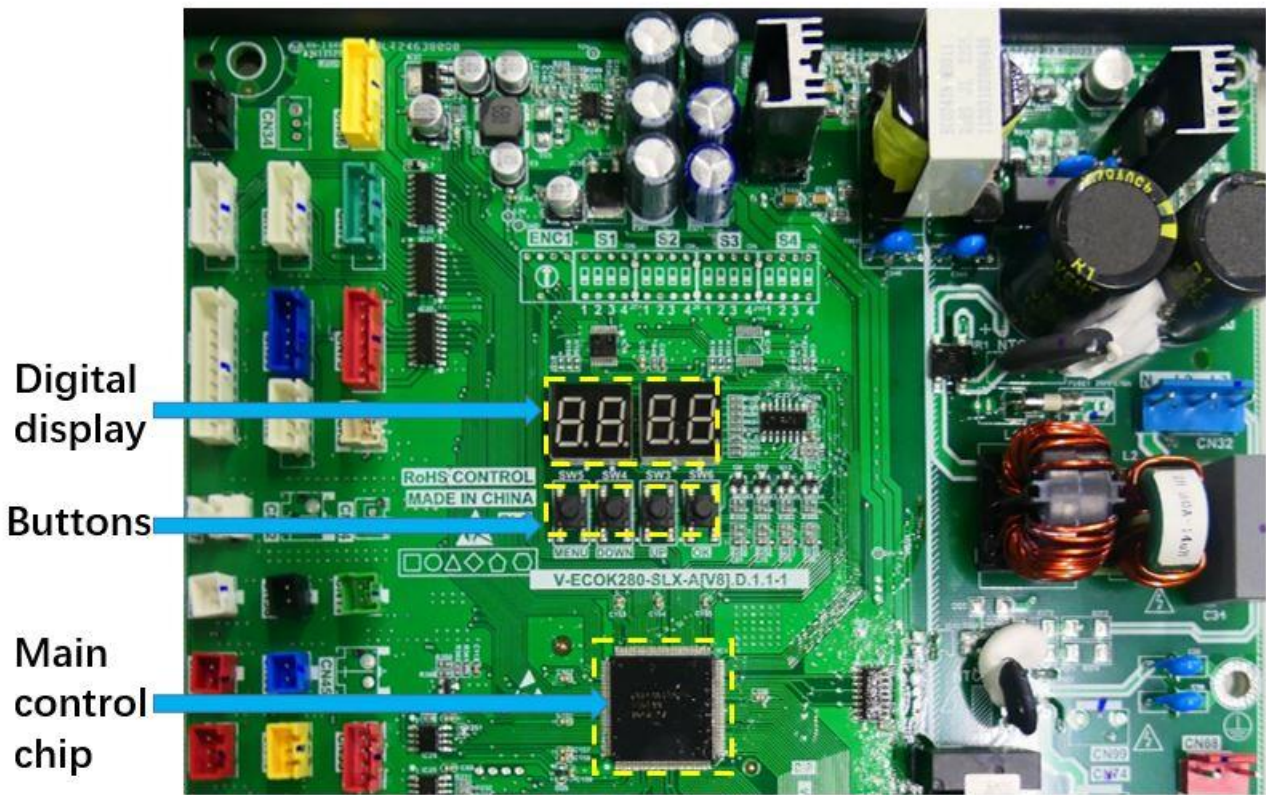

2.2.2 Function of buttons SW3 to SW6

Table 5-2.2: Function of buttons SW3 to SW6

Button	Function
SW3 (UP)	In menu mode: previous and next buttons for menu modes.
SW4 (DOWN)	Not in menu mode: previous and next buttons for system check information.
SW5 (MENU)	Enter / exit menu mode.
SW6 (OK)	Confirm to enter specified menu mode.

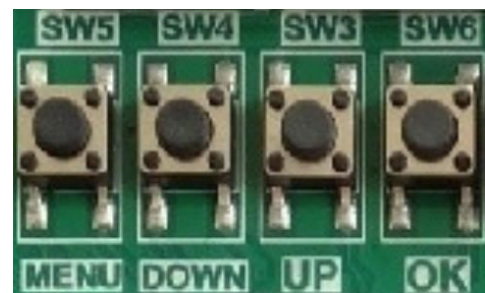

2.2.3 Digital display output
Table 5-2.4: Digital display output in different operating states

Outdoor unit state		Parameters displayed on DSP1	Parameters displayed on DSP2
Standby		The address of outdoor unit	The number of indoor units in communication with the outdoor units
Normal operation	For single compressor units	--	Running speed of the compressor in rotations per second
Other operation state		Operation state code	Operation state step
Error or protection		Placeholder and error or protection cod	
In menu mode		Display menu mode code Refer to <i>Table 4-2.3 Menu mode function:</i>	
System check		Display system check code Refer to <i>Table 4-3.1 system check list</i>	

3. Compressor & Fan drive board

3.1 Corresponding table of Compressor & Fan drive board and outdoor units

Table 5-2.5: Corresponding table of Compressor & Fan drive board and outdoor units

Compressor & Fan drive board model	Model
35A	8-14HP
50A	16-18HP
75A	20-22HP

3.2 Compressor & Fan drive board of 35A

Figure 5-2.3: Compressor & Fan drive board of 35A

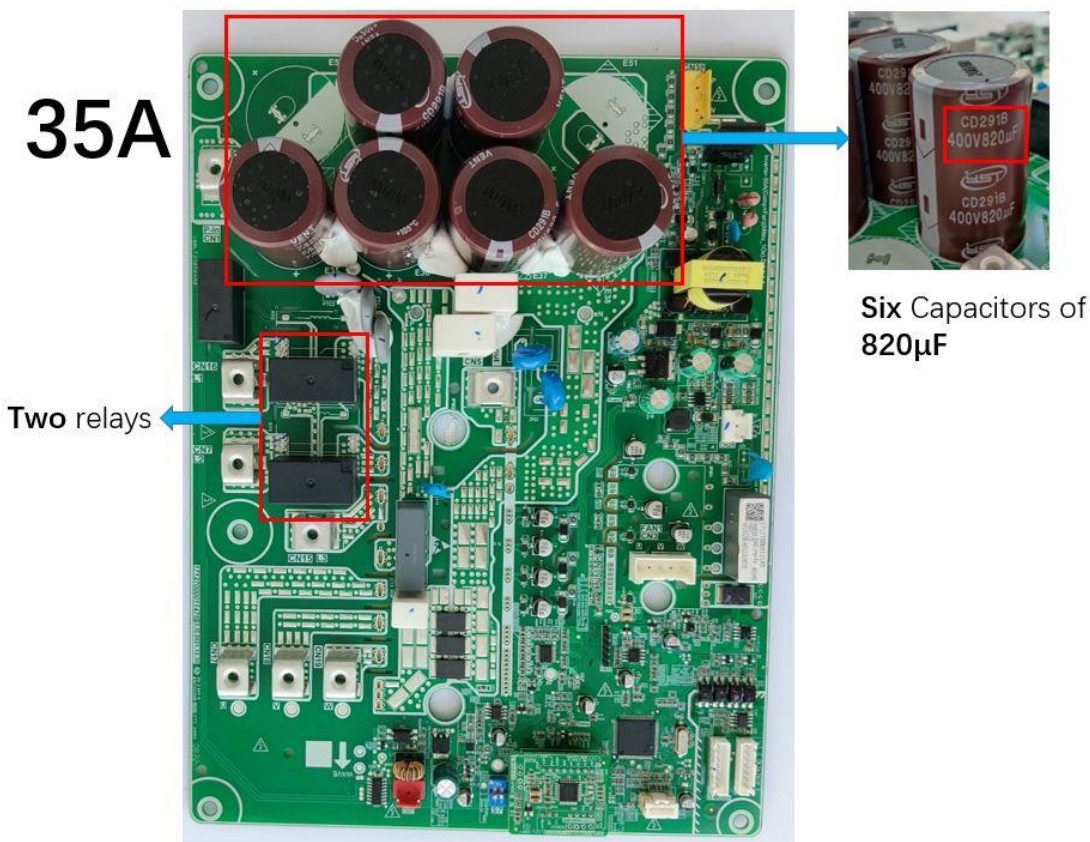

3.3 Compressor & Fan drive board of 50A

Figure 5-2.4: Compressor & Fan drive board of 50A

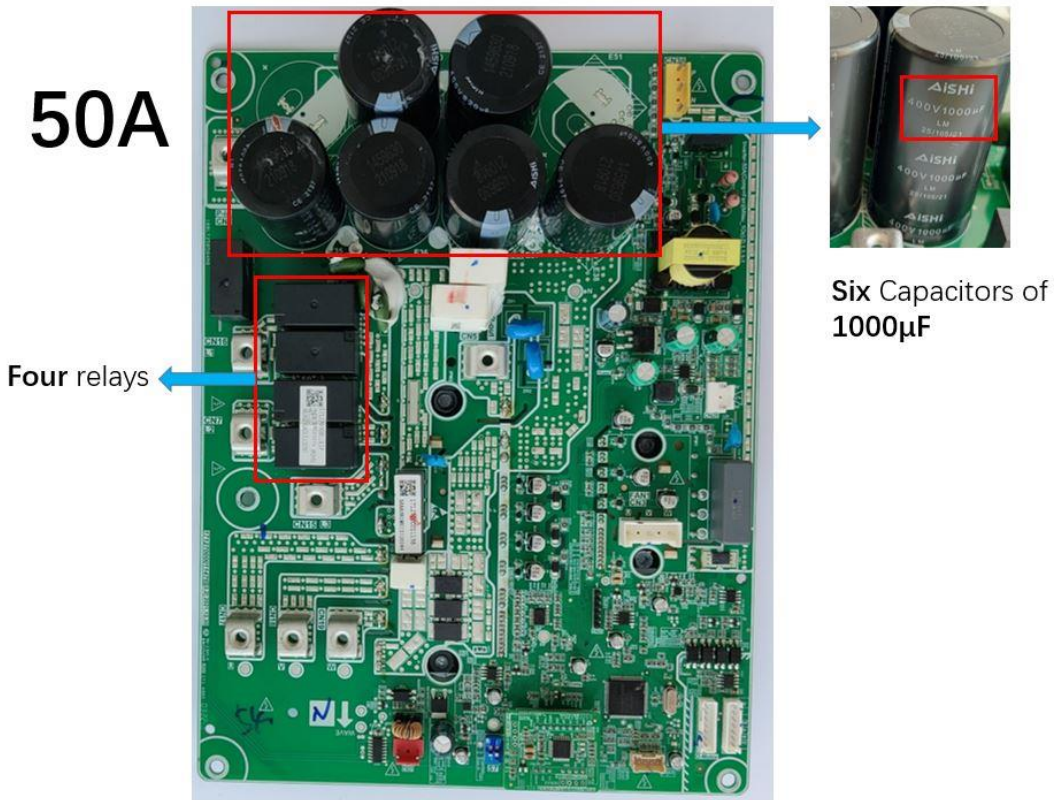

Six Capacitors of 1000µF

3.4 Compressor & Fan drive board of 75A

Figure 5-2.5: Compressor & Fan drive board of 75A

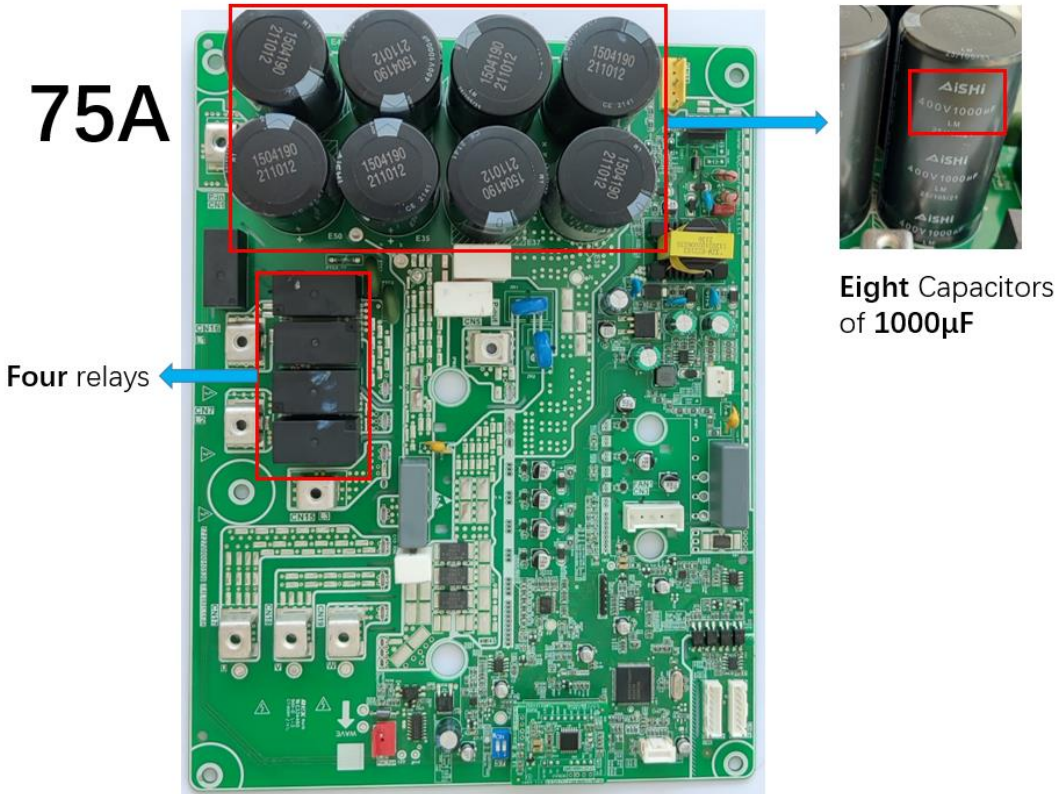

Eight Capacitors of 1000µF

3.5 Compressor & Fan drive board ports

Figure 5-2.6: Compressor & Fan drive board ports of 50A

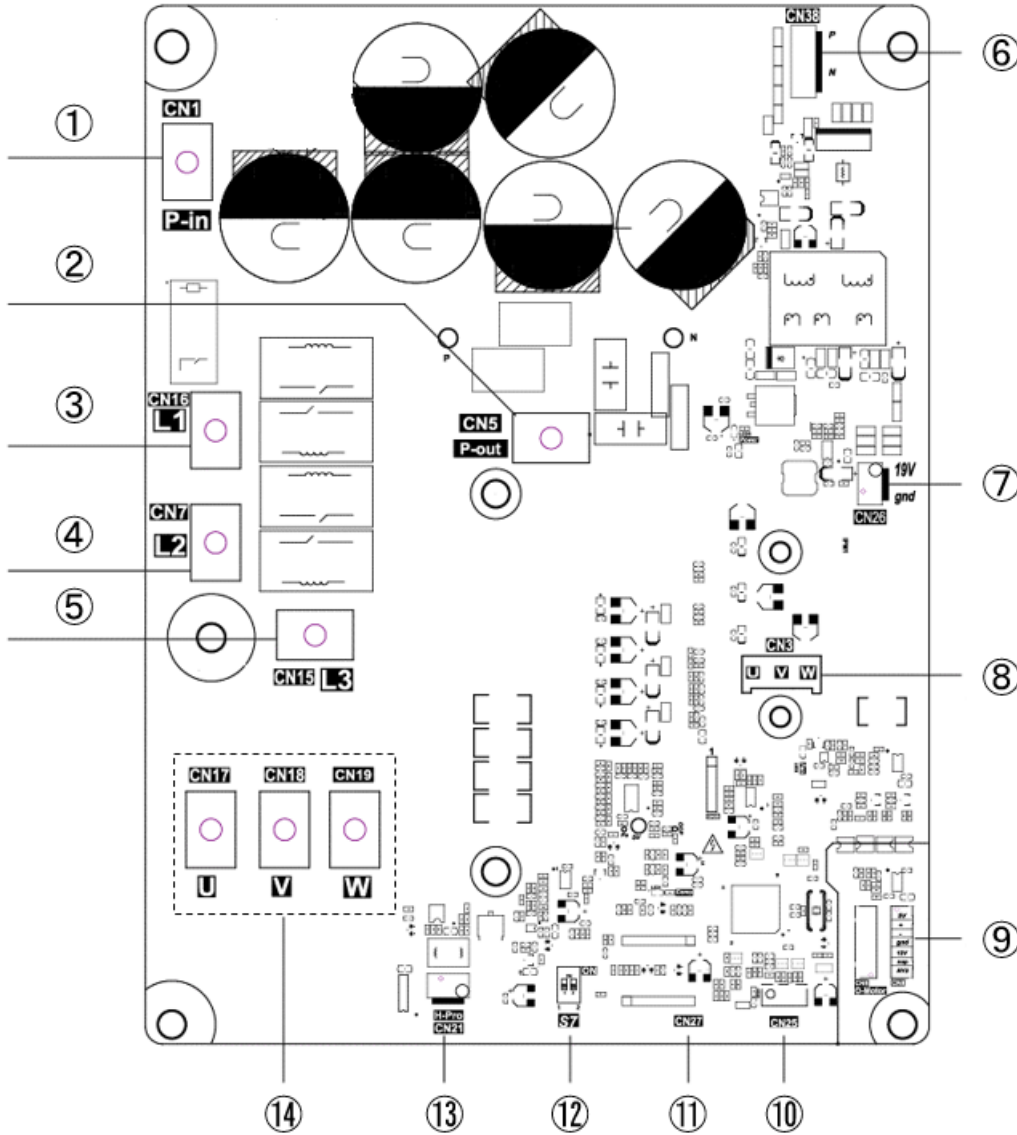

Table 5-2.6: Compressor & Fan drive board port

Label in Figure 5-2.5	Port code	Feature identifier	Content	Port voltage
1	CN1	P-in	Positive pole Input terminal of the high voltage capacitors (connected to reactor)	438Vdc-650Vdc(Rated at 540Vdc)
2	CN5	P-out	Positive pole output terminal of the three-phase rectifier (connected to reactor)	438Vdc-650Vdc(Rated at 540Vdc)
3	CN16	L1	Three phase power input of L1 phase	310Vac-460Vac(Rated 380Vac between phases)
4	CN7	L2	Three phase power input of L2 phase	310Vac-460Vac(Rated 380Vac between phases)
5	CN15	L3	Three phase power input of L3 phase	310Vac-460Vac(Rated 380Vac between phases)



Table 5-2.6: Compressor & Fan drive board port

Label in Figure 5-2.5	Port code	Feature identifier	Content	Port voltage
6	CN38	-	Power supply terminal for DC fan drive board (P,N) (Reserved)	438Vdc~650Vdc(Rated 540Vdc; P is positive, N is negative)
7	CN26	-	Fan module controls power supply(Reserved)	19V
8	CN3	DCFAN	Three phase output of the inverter ,connected to the DC fan	0~100%*input voltage(varying)
9	CN8/CN9	O-Motor	Communication port between main control board and Inverter drive board	Ports from top to bottom are defined as follows: 5V, +, -, GND, 12V, empty, and Ry2.
10	CN25	-	Debug port	--
11	CN27	-	PED Diagnostic Module	--
12	S7	-	Dial switches of address setting (Compressor & Fan drive module)	--
13	CN21	H-Pro	High pressure switch connection	Close: 0 Vdc ; Open: 6 Vdc
14	CN17/18/19	U/V/W	Three phase output of the inverter ,connected to the compressor	0~100%*input voltage(varying)

Notes:

The Compressor & Fan drive board ports of 35A and 75A is same as 50A.

Table 5-2.7: Compressor & Fan drive board switch settings

Switch	Setting	Switch positions1	Description
 S7	Serial number		Fan A
			Fan B

3.6 The installation guide of Compressor & Fan drive board

Figure 5-2.7: The installation guide of Compressor & Fan drive board

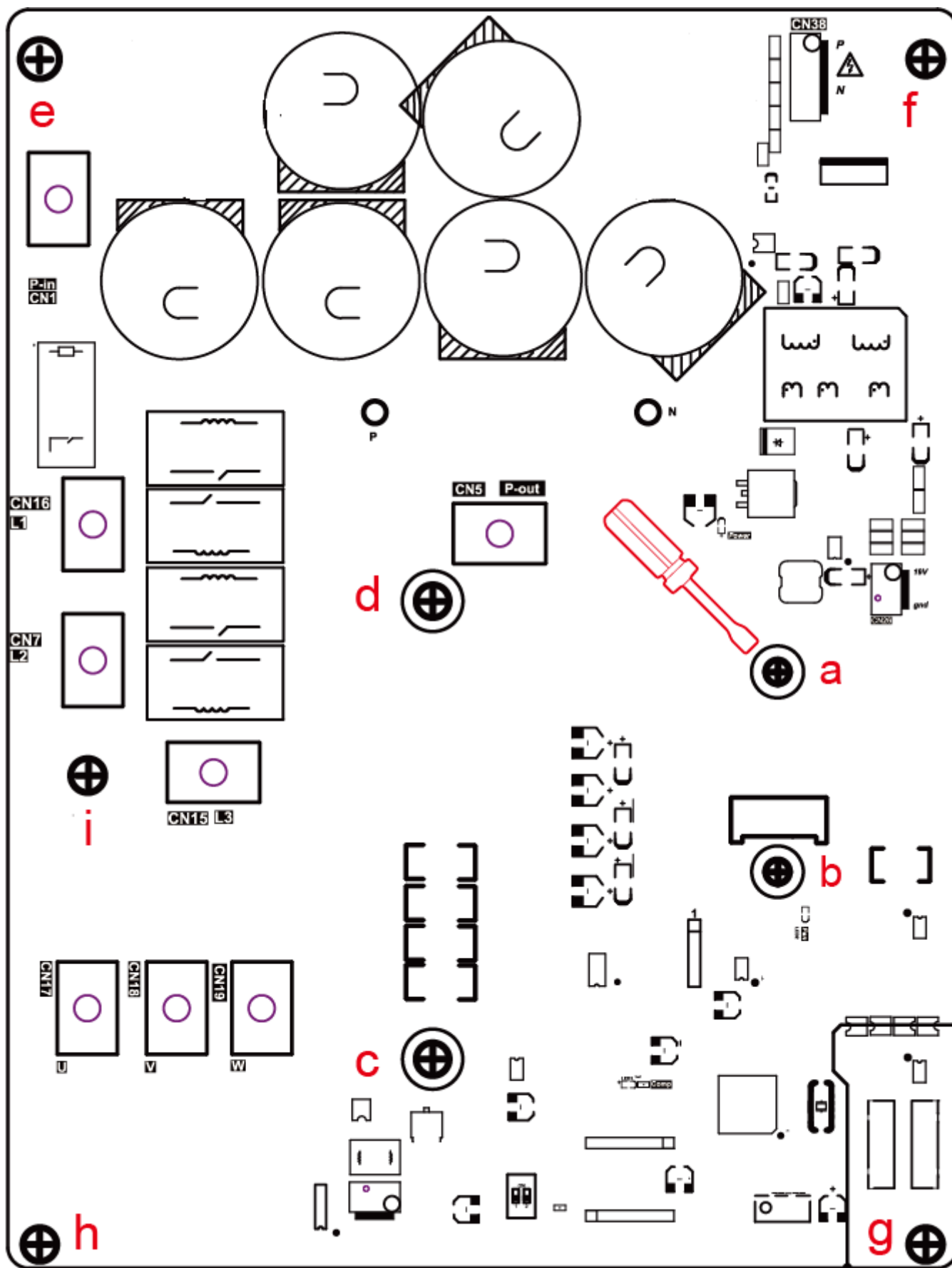

1. Before maintaining or repairing the outdoor unit, cut off the power supply of the outdoor unit for 5 minutes and use a multimeter to ensure that the voltage is zero to avoid electric shock. Notice The unit has the low-power standby function. After entering this mode, only the power indicator of the main board is on.

2. Perform the following steps to install the module board:

- ①. Evenly apply thermal silicone grease on the IPM (The cooling panel on the back of Compressor & Fan drive board)
- ②. Pre-fix screws a, b, c and d respectively, and then tighten them successively after pre-fix;
- ③. Fix e, f, g, h and i screws.
- ④. The order of steps ②③ cannot be reversed; Do not tighten the module directly without pre-fixing, otherwise the module will be damaged by force when other screws are fixed.
- ⑤. Do not directly fix e and f screws, hang the module board and then fix other screws;

3.7 Fan drive board

Figure 5-2.8: Fan drive board

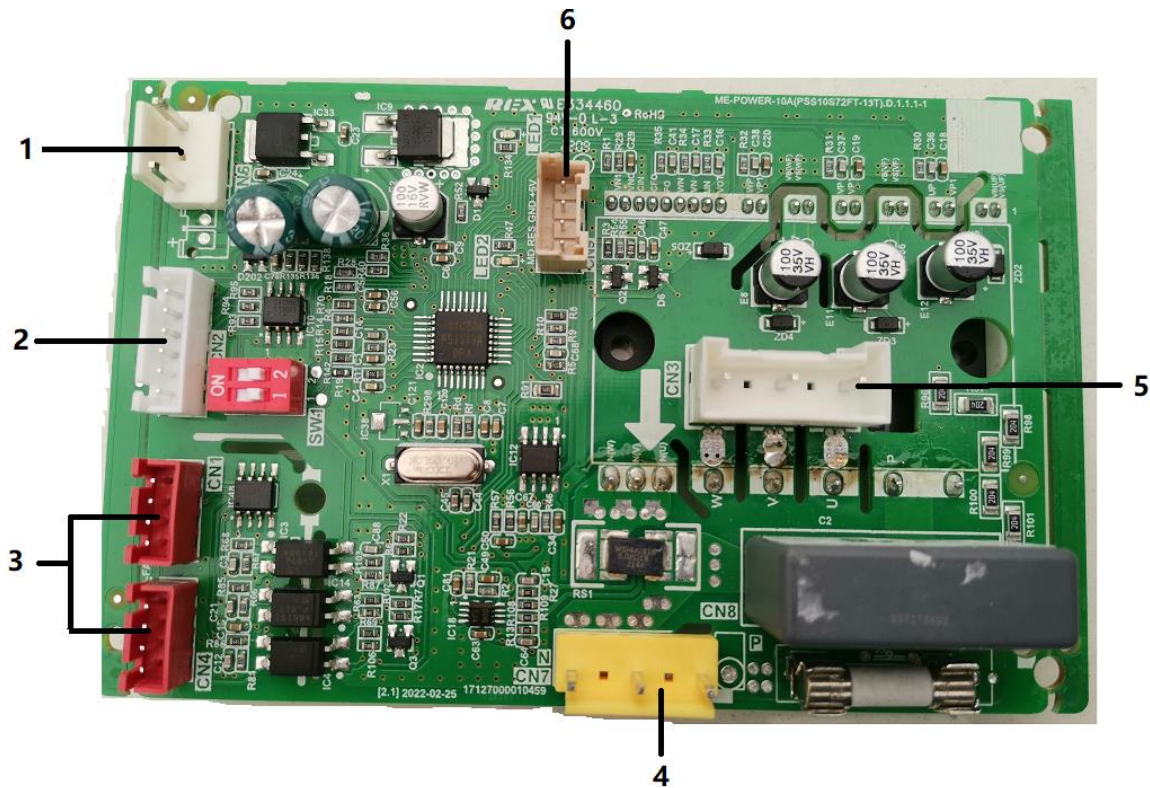

Table 5-2.6: Compressor & Fan drive board port

Label in Figure 5-2.5	Port code	Content	Port voltage
1	CN6	Fan module controls power supply(Reserved)	19V
2	CN2	EEPROM Program burning port	5V
3	CN4\CN1	Communication port between main control board and Fan drive board	5V
4	CN7	Power supply terminal for DC fan drive board (P,N) From main control board.	Rated voltage 540V DC P(+), N(-)
5	CN3	Output power supply for fan motor	46~460V AC
6	CN9	Main Program burning port	--

EasyFit VRF 50Hz

4. Wiring Diagrams

Figure 5-3.1: EasyFit outdoor unit wiring diagram

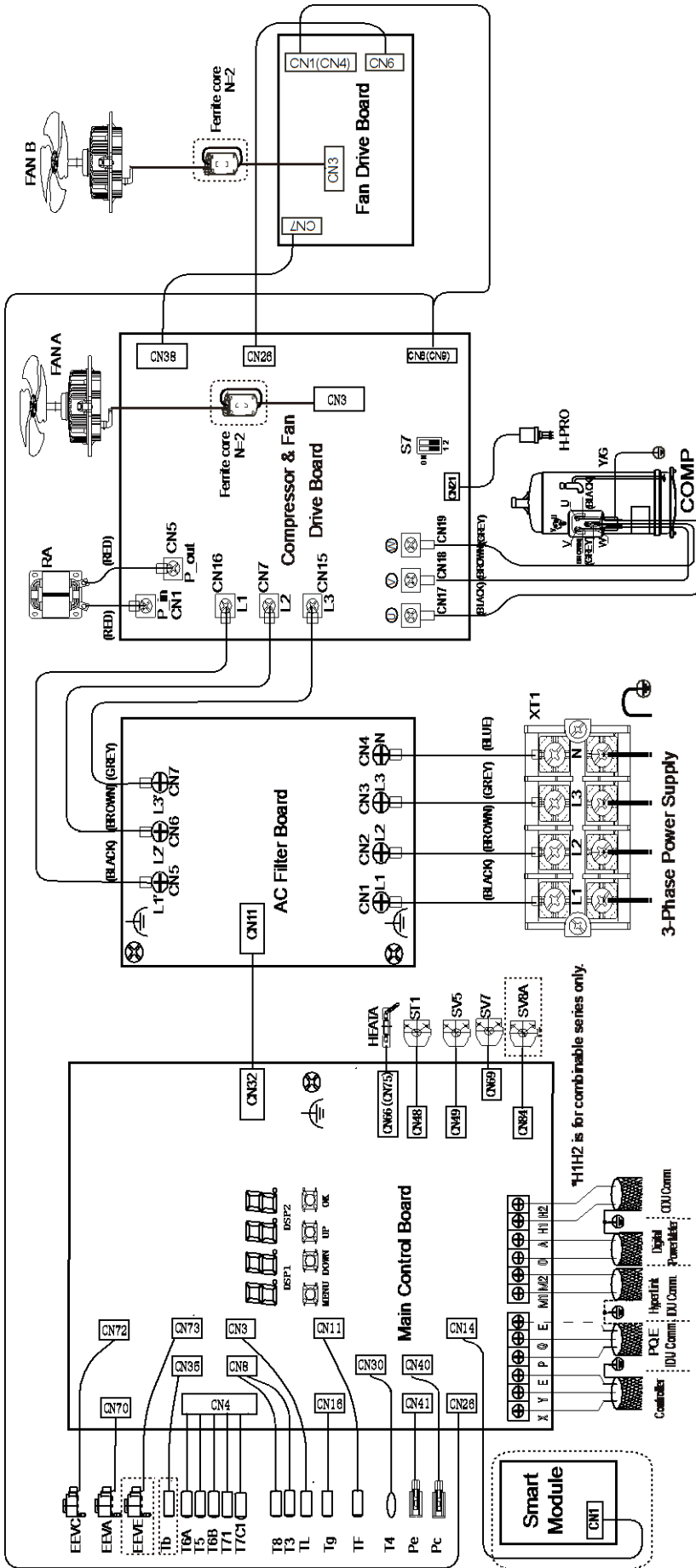

CODE	NAME	CODE	NAME	CODE	NAME
COMP	Compressor	T3	Main exchanger pipe temperature sensor	T8	Condenser inlet temperature sensor
XT1	Terminal block	T4	Outdoor ambient temperature sensor	TL	Condenser outlet temperature sensor
HEATA	Crankcase heater	T5	Liquid stop valve inlet temperature sensor	T9	Gas pipe temperature sensor
RA	Reactances	T6A	Microchannel heat exchanger inlet temperature sensor	H-PRO	High pressure ON/OFF switch
ST1	Four-way valve	T6B	Microchannel heat exchanger outlet temperature sensor	FAN A/FAN B	DC Fan
SV5-SV8A	Solenoid valve	T7C1	Discharge temperature sensor	EEVA/EEVC	Electronic expansion valve
Pc	High pressure sensor	T71	Suction temperature sensor	EEVE	Electronic expansion valve
Pe	Low pressure sensor	TF	Inverter-module heatsink temperature sensor		

This wiring diagram is for reference only, actual product may vary.

Attention:

1. The shield layer at both ends of all shielded wires should be connected to the electric control box sheet metal.
2. It is forbidden to connect the power cable to the communication terminal, otherwise the main control board will be damaged.
3. It is forbidden to connect both the M1M2 communication line and the PQ communication line in one system, refer to the communication wiring configuration section of the manual.

Part 6

Diagnosis and Troubleshooting

1 Error Code Table.....	76
2 Error in Main Control.....	81
3 Error in Compressor Driver	158
4 Error in Fan Drive	168
5 Appendix.....	177

1 Error Code Table

1.1 Outdoor Error code table

Table 6-1.1 Outdoor Error code table

Error code	Error description	Remarks	Manual re-start required ²
A01	Emergency shutdown	Outdoor unit's fault	NO
AAx	No.x Inverter driver board does not match the main control board	Outdoor unit's fault	NO
xA61	No.x slave unit error	Slave unit's fault	NO
xb53	No.x Heat dissipation fan error	system failure	YES
C13	The address of outdoor Unit is repeated	communication failure	NO
C21	Communication error between indoor and master outdoor unit	communication failure	NO
C26	Number of indoor units detected by master unit has decreased or less than the setting amount	communication failure	NO
C28	Number of indoor units detected by master unit has increased or more than the setting amount	communication failure	NO
xC31	Communication error between No.x slave outdoor unit and master outdoor unit	communication failure	NO
C32	Number of slave units detected by master unit has decreased	communication failure	NO
C33	Number of slave units detected by master unit has increased	communication failure	NO
xC41	Communication Error between main control board and No.x inverter driver board	communication failure	NO
E41	Outdoor ambient temperature sensor (T4) error(open/short)	sensor error	NO
F31	Microchannel heat exchanger outlet temperature sensor(T6B) error(open/short)	sensor error	NO
F41	Main heat exchanger pipe temperature sensor (T3) error(open/short)	sensor error	NO
F51	Microchannel heat exchanger inlet temperature sensor(T6A) error(open/short)	sensor error	NO
F62	Inverter driver board temperature (Tf) protection	Temperature protection	NO
F63	Non-inductive resistance temperature(Tr)protection	Temperature protection	NO
F6A	F62 protection occurs 3 times in 100 minutes	Temperature protection	YES
xF71	Discharge temperature sensor(T7C1/T7C2) error (open/short)	sensor error	YES
F72	Discharge temperature(T7C1/T7C2) protection	Temperature protection	NO
F75	Compressor discharge insufficient superheat protection	Temperature protection	NO
F7A	F72 protection occurs 3 times in 100 minutes	Temperature protection	YES

Error code	Error description	Remarks	Manual re-start required ²
F81	Gas pipe temperature sensor (Tg) error (open/short)	sensor error	NO
F91	Liquid pipe temperature sensor (T5) error (open/short)	sensor error	NO
FA1	Outdoor Heat exchanger gas temperature sensor (T8) error (open/short)	sensor error	NO
FC1	Outdoor heat exchanger liquid temperature sensor (TL) error (open/short)	sensor error	NO
xFd1	Compressor suction temperature sensor (T71/T72) error (open/short)	sensor error	NO
Fp1	Electric control box chamber temperature sensor (Tb) error (open/short)	sensor error	NO
xL01	xL1* or xL2* error occurs 3 times in 60 minutes	power-on again	YES
xL--	No.(x) compressor error, "--" refer to Table 6-1.3 Compressor drive error code table	Troubleshoot errors according to the Service Manual	YES
xJ01	xJ1* or xJ2* error occurs 10 times in 60 minutes	power-on again	YES
xJ--	No.(x) fan motor error, "--" refer to Table 6-1.4 Fan motor error code table	Troubleshoot errors according to the Service Manual	YES
P11	High pressure sensor error	sensor error	NO
P12	High pressure protection	Pressure protection	NO
P13	High pressure switch protection	Pressure protection	NO
P14	P12 protection occurs 3 times in 60 minutes	Pressure protection	YES
P21	Low pressure sensor error	Sensor error	YES
P22	low pressure protection	Pressure protection	NO
P24	Abnormal rise of low pressure	Pressure protection	NO
P25	P22 protection occurs 3 times in 100 minutes	Pressure protection	YES
xP32	No.(x) compressor high DC bus current protection	Current protection	NO
xP33	xP32 protection occurs 3 times in 100 minutes	Current protection	YES
P51	High AC voltage protection	Voltage protection	NO
P52	Low AC voltage protection	Voltage protection	NO
P53	Phase B and N of the power cable are connected to the opposite protection	Power protection	YES
P54	DC bus low voltage protection	Voltage protection	NO
P55	DC bus ripple over protection	Power protection	YES
xP56	No.(x) Inverter driver board DC bus low voltage error	Power protection	YES
xP57	No.(x) Inverter driver board DC bus high voltage error	Power protection	YES
xP58	No.(x) Inverter driver board DC bus excessively high voltage error	Power protection	YES

Error code	Error description	Remarks	Manual re-start required ²
P71	EEPROM error	E party error	YES
Pb1	HyperLink overcurrent error	Overcurrent protection	YES
Pd1	Anti-condensation protection	condensation	NO
Pd2	Pd1 protection occurs 2 times in 60 minutes	condensation	YES
1b01	Electronic expansion valve (EEVA) error	missing Connection	YES
2b01	Electronic expansion valve (EEVB) error	missing Connection	YES
3b01	Electronic expansion valve (EEVC) error	missing Connection	YES
4b01	Electronic expansion valve (EEVE) error	missing Connection	YES
bA1	HyperLink cannot open or close indoor unit's Electronic expansion valve	System error	YES

Note:

'x' is a placeholder for the fan or compressor address, with 1 representing fan A or compressor A and 2 representing fan B or compressor B.

1.2 Installation and debugging error code table

Table 6-1.2 Installation and debugging error code table

Error code	Error description	Remarks	Manual re-start required ²
U11	Outdoor unit model is not set	System configuration	YES
U12	Outdoor unit Capacity setting error	System configuration	YES
U21	System contains the old Indoor Unit with old platforms	System configuration	YES
U31	The test run was never successful, and did not run within 30 minutes after power-on	Pilot run	YES
U32	Outdoor temperature out of operating range	Pilot run	YES
U33	Indoor temperature out of operating range	Pilot run	YES
U34	Outdoor and indoor temperature out of operating range	Pilot run	YES
U35	Liquid side stop valve is not opened	Pilot run	YES
U37	Gas side stop valve is not opened	Pilot run	YES
U38	Outdoor unit has No address	Outdoor Unit set	YES
U3A	The refrigerant pipe connection is not consistent with the communication cable	Pilot run	NO
U3b	The installation environment is abnormal	Pilot run	YES
U3C	The VIP indoor unit is not set (valid in Changeover priority mode)	Pilot run	NO
U4x	Overconnection ratio contains U41-U46	System configuration	YES
U51	Outdoor unit of Individual Series is installed in combined system.	System configuration	YES
U53	Different series of outdoor units are detected in the same VRF system.	System configuration	YES

1.3 Compressor drive error code table

Table 6-1.3 Compressor drive error code table

Error code	Error description	Remarks	Manual re-start required ²
xL1E	Hardware overcurrent	current overload error	NO
xL11	Software overcurrent		NO
xL12	Software overcurrent protection last 30s		NO
xL2E	Module overtemperature protection	Over-temperature error	NO
xL3E	Low bus voltage error	Power supply error	NO
xL31	High bus voltage error		NO
xL32	The bus voltage is excessively high		NO
xL33	Bus voltage drop fault		NO
XL43	The current sampling bias is abnormal	Hardware error	NO
xL5E	Startup failed	Control error	NO
xL51	Out-of-step error	Control error	NO
xL52	Locked-rotor protection	Motor error	NO
xL6E	Compressor motor lack of phase protection	Diagnosis error	NO

Note: 'x' is a placeholder for the fan or compressor address, with 1 representing fan A or compressor A and 2 representing fan B or compressor B.

1.4 Fan motor error code table

Table 6-1.4 Fan motor error code table

Code	Error description	Remarks	Manual re-start required ²
xJ1E	Hardware overcurrent	current overload error	NO
xJ11	Software overcurrent		NO
xJ12	Software overcurrent protection last 30s		NO
xJ2E	Module overtemperature protection	Over-temperature error	NO
xJ3E	Low bus voltage error	Power supply error	NO
xJ31	High bus voltage error		NO
xJ32	The bus voltage is excessively high		NO
xJ43	The current sampling bias is abnormal	Hardware error	NO
xJ5E	Startup failed	Control error	NO
xJ51	Out-of-step error		NO
xJ52	Locked-rotor protection		NO
xJ6E	Motor lack of phase protection	Diagnosis error	NO

Note: 'x' is a placeholder for the fan address, with 1 representing fan A and 2 representing fan B

1.5 Status prompt code table

Table 6-1.5 Status prompt code table

Status code	Code description	Remarks	Manual re-start required2
d0x	Oil return, "x" is the current step node	Status hint	NO
dfx	Defrost, "x" is the current step node	Status hint	NO
d11	The outdoor ambient temperature exceeds the upper limit (Heating mode)	Status hint	NO
d12	The outdoor ambient temperature exceeds the lower limit (Heating mode)	Status hint	NO
d13	The outdoor ambient temperature exceeds the upper limit (Cooling mode)	Status hint	NO
d14	The outdoor ambient temperature exceeds the lower limit (Cooling mode)	Status hint	NO
d31	Refrigerant judgment: no result	Status hint	NO
d32	Refrigerant quantity judgment:Significantly excessive	Status hint	NO
d33	Refrigerant quantity judgment:Slightly excessive	Status hint	NO
d34	Refrigerant quantity judgment:normal	Status hint	NO
d35	Refrigerant quantity judgment:Slightly insufficient	Status hint	NO
d36	Refrigerant quantity judgment:Significantly insufficient	Status hint	NO
d41	System exist no power indoor unit, HyperLink is controlling this indoor unit's valve	Status hint	NO

Note: the above non-error code, no troubleshooting

2 Error in Main Control

2.1 A01: emergency shutdown of Outdoor Units

2.1.1 Digital display output



2.1.2 Description

- Compressor protection shut down
- All Outdoor Units stop running
- Error codes are displayed only on master unit.

2.1.3 Trigger / recover condition

(1) Check menu N28 = 0:

- Trigger condition: Dry contact x (main control board CN55/CN56) is short-circuited
- Recover condition: remove Dry contact x short-circuited
- Reset method: Resume automatically

(2) Check menu N28 = 1 :

- Trigger condition: Dry contact x (PCB CN55/CN56) is open-circuited
- Recover condition: remove Dry contact x short-circuited
- Reset method: Resume automatically

2.1.4 Possible causes

- Damaged outdoor unit main control board.
- Centralized controller command

2.1.5 Procedure

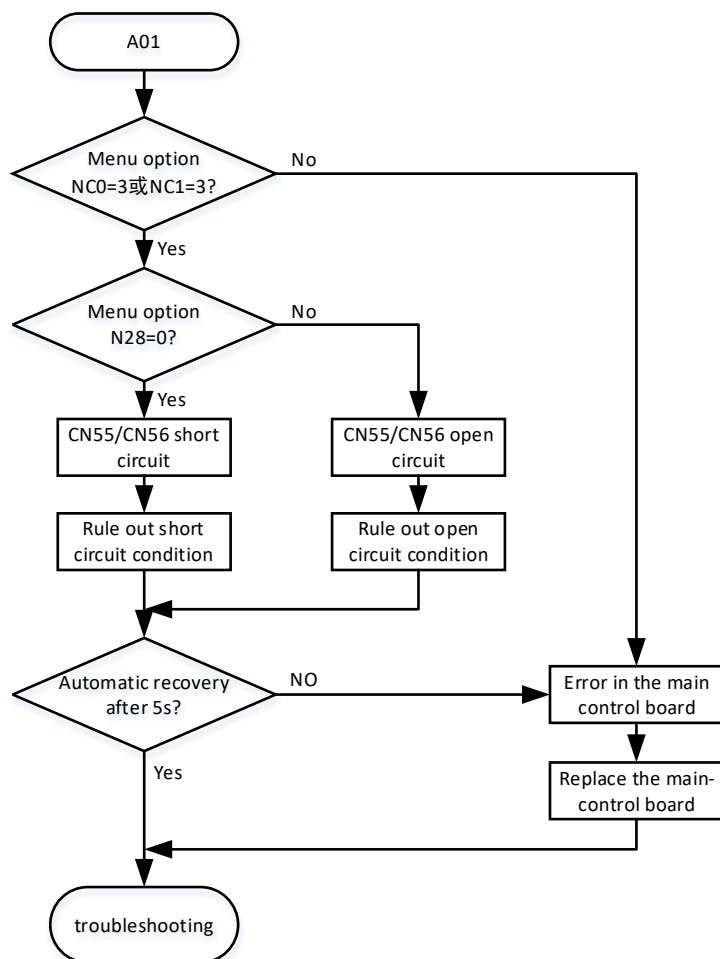

2.2 xA61: No.x slave unit error

2.2.1 Digital display output



2.2.2 Description

- xA6 shows The Outdoor Unit at address X is in error(x=1,2,3)
- All Outdoor Units stop running
- Error code are displayed only on master unit.

2.2.3 Trigger / recover condition

- Trigger condition: Slave machine is in error.
- Recover condition: Error of slave unit recover
- Reset method:Resume automatically

2.2.4 Possible causes

- Driven machine is in error

2.2.5 Procedure

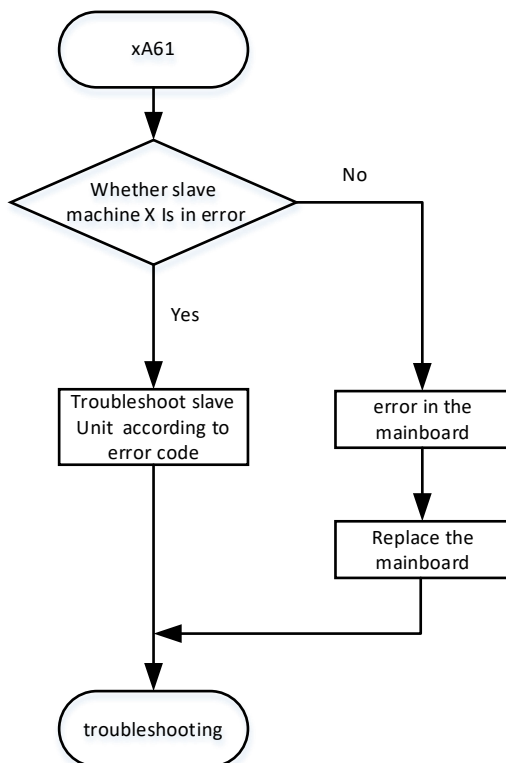

2.3 AAx: Inverter driver board X does not match the main control board

2.3.1 Digital display output



2.3.2 Description

- No.x Inverter driver board does not match the main control board
- All units stop running.
- Error code is displayed on the unit with the error

2.3.3 Trigger / recover condition

- Trigger condition:the internal driver parameters of the module board do not match Outdoor Units
- Recover condition:the internal driver parameters of the module board match Outdoor Units
- Reset method: Rectify the error and power-on again

2.3.4 Possible causes

- Model error of Inverter driver board
- The model of Outdoor Unit is incorrectly set.
- Main control board is damaged

2.3.5 Procedure

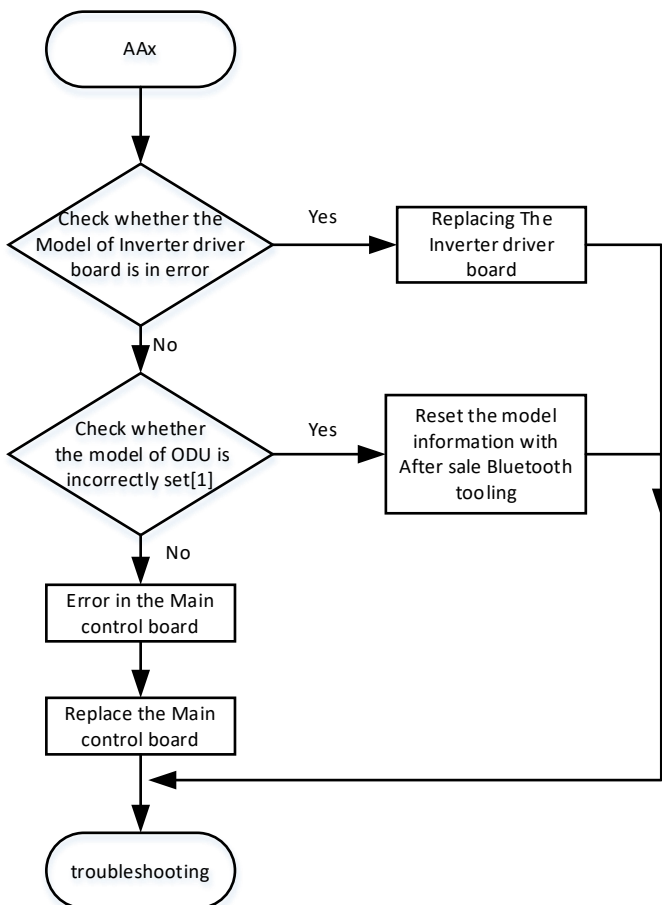

Notes:

[1]. Use after-sale Bluetooth tooling connect with outdoor unit can check the model of ODU.

2.4 xb53: No.x Recirculation fan error

2.4.1 Digital display output



2.4.2 Description

- No.x Recirculation Fan[1] is in error
- All units stop running.
- Error code is displayed on the unit with the error

2.4.3 Trigger / recover condition

- Trigger condition: the difference between the actual fan speed and the set fan speed is 300rpm, lasting for 50s.
- Recover condition: the difference between the actual fan speed and the set fan speed is within 300rpm
- Reset method: Rectify the error and power-on again

2.4.4 Possible causes

- The cable connect Recirculation Fan and Recirculation Fan power supply disconnected.
- The Recirculation Fan is damaged
- The Recirculation Fan power supply is damaged
- ODU main control board is damaged

2.4.5 Procedure

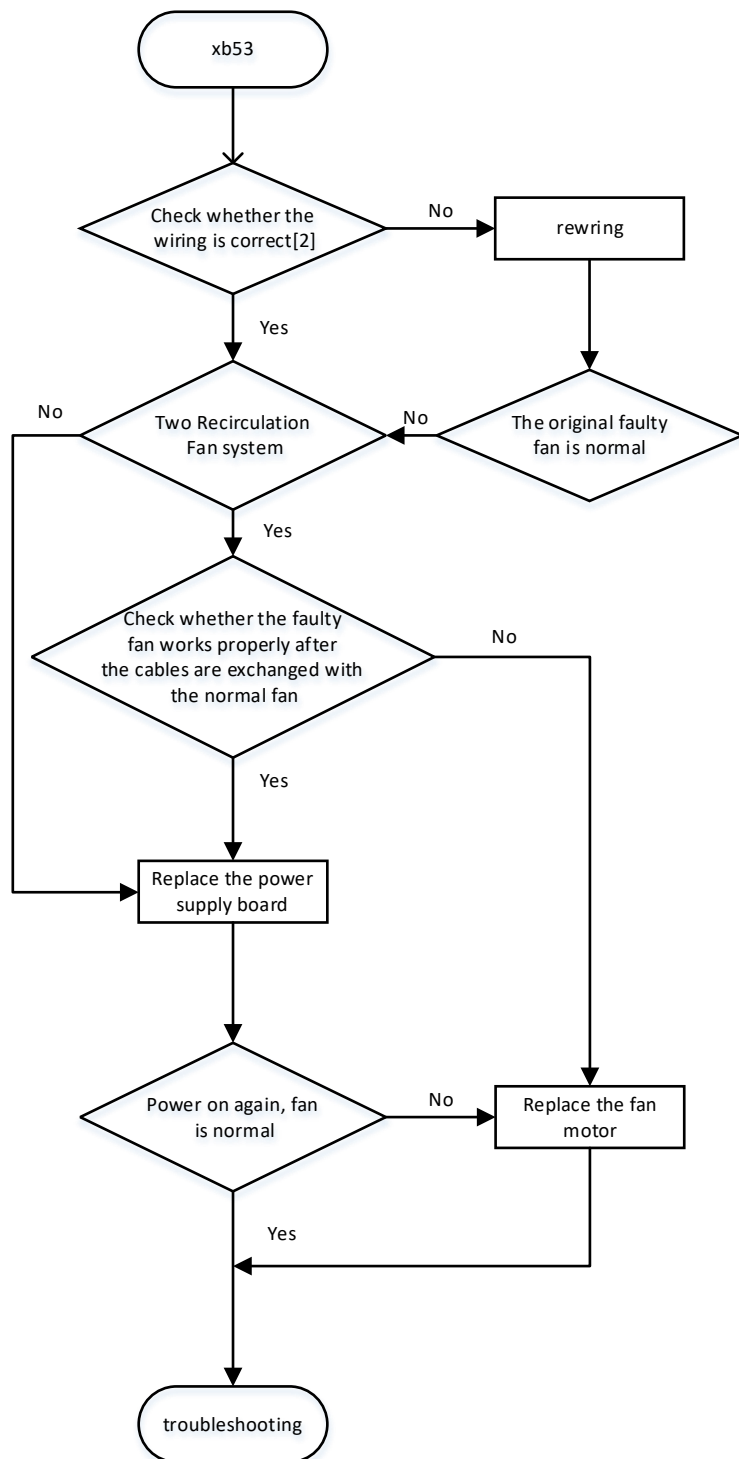

Notes:

- [1]. The fan runs only when the fan or compressor is running, but does not run in standby mode
- [2]. Refer to the Part 5 *Figure 5-2.1 and Table 5-2.1*

2.5 bA1: HyperLink cannot open or close IDU's Electronic expansion valve

2.5.1 Digital display output

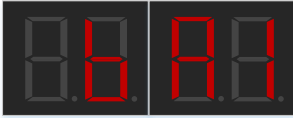

2.5.2 Description

- When some IDUs are powered off, HyperLink fail to close their EEV.
- All units stop running.
- Error code is only displayed on the master unit

2.5.3 Trigger / recover condition

- Trigger condition: when some IDUs in the system are powered off, HyperLink board voltage $< 17V$
- Recover condition: HyperLink board voltage $> 17V$
- Reset method: Resume manually
-

2.5.4 Possible causes

- HyperLink Diameter of communication line $< 1.5mm^2$;
- The total length of HyperLink communication cables exceeds 200 meters without a repeater;
- The number of powered off IDUs > 10 and have no repeater:
- Indoor main control board is damaged;
- Outdoor main control board is damaged.

2.5.5 Procedure

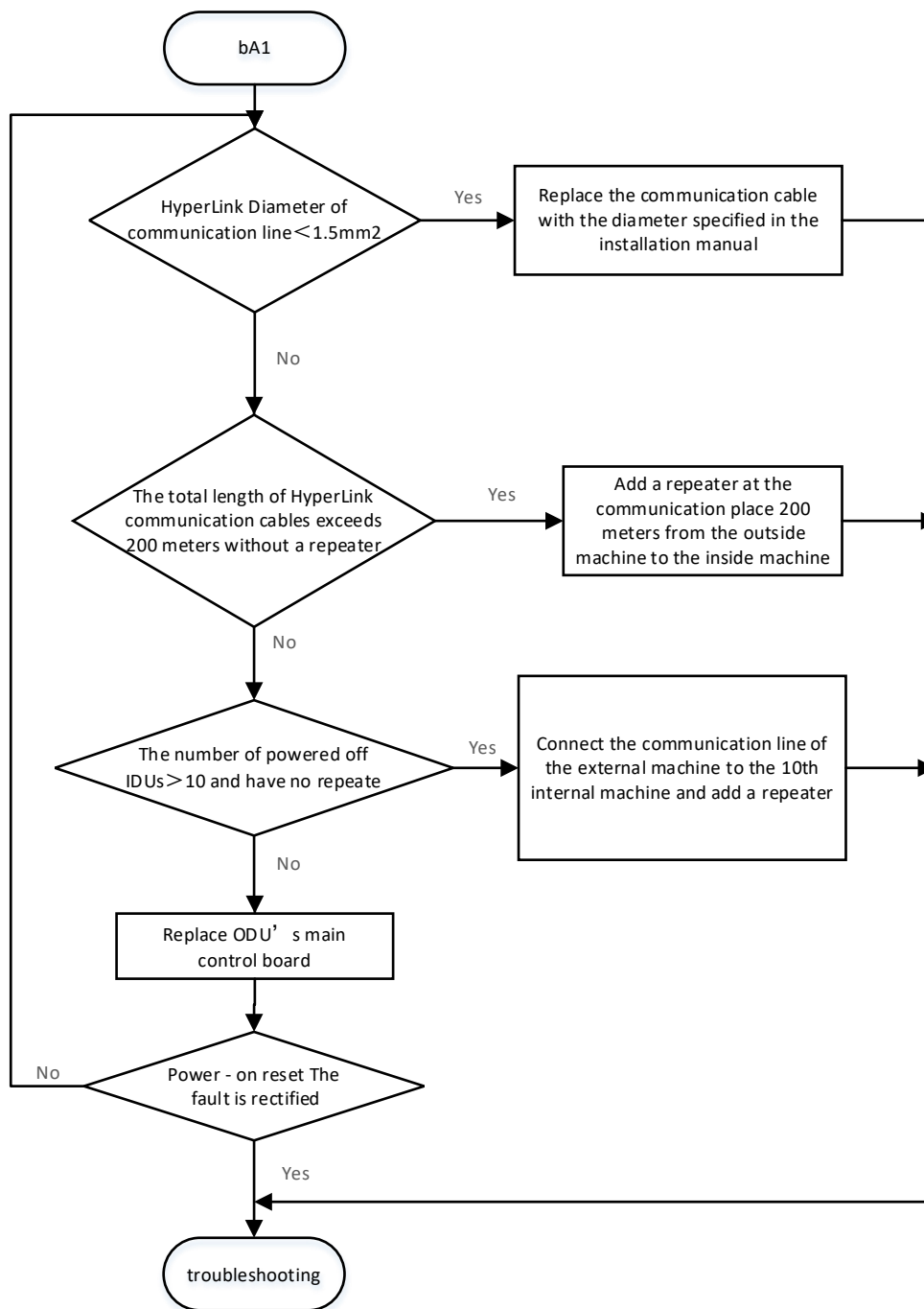

2.6 U38: Outdoor Unit has no address.

2.6.1 Digital display output



Description

- Outdoor Unit has no address.
- The ODU with error can not run.
- The master outdoor unit cannot communicate with indoor units.

2.6.2 Trigger / recover condition

- Trigger condition: The ODU’s address is not set
- Recover condition: Enter the menu N40 to reset the outdoor unit address. The master address is 0 and the slave address is 1 ~ 3
- Reset method: Resume manually

2.6.3 Possible causes

- The ODU’s address is not set
- Outdoor main control board is damaged

2.6.4 Procedure

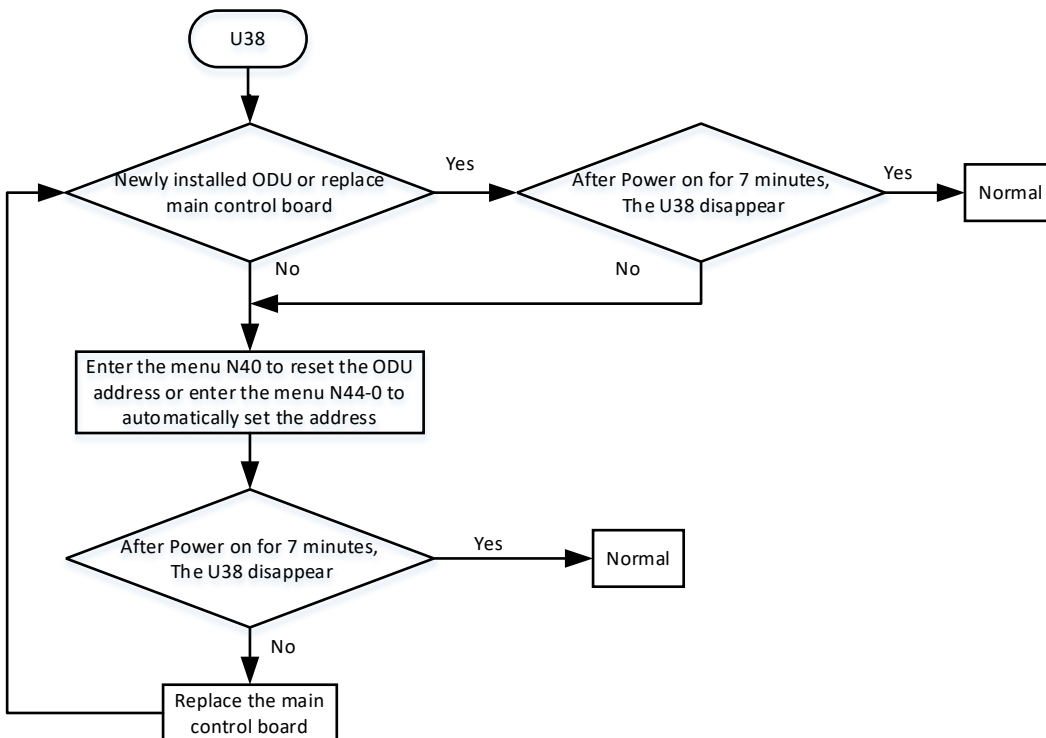

Notes:

[1]After setting the outdoor unit address, waiting for 30 seconds then, powering off the ODU, next waiting another 30 seconds, and then powering on the ODU again.

2.7 C13: The address of Outdoor Unit is repeated

2.7.1 Digital display output



2.7.2 Description

- The address of Outdoor Unit is repeated.

2.7.3 Trigger /recover condition

- Trigger: Two or more outdoor units in the Combined system have the same address
- Recover condition: the address of master and slave unit are set to be 0~3 successively
- Reset method: Manually restart

2.7.4 Possible causes

- Two or more outdoor units in the Combined system have the same address
- Damaged outdoor main control board

2.7.5 Procedure

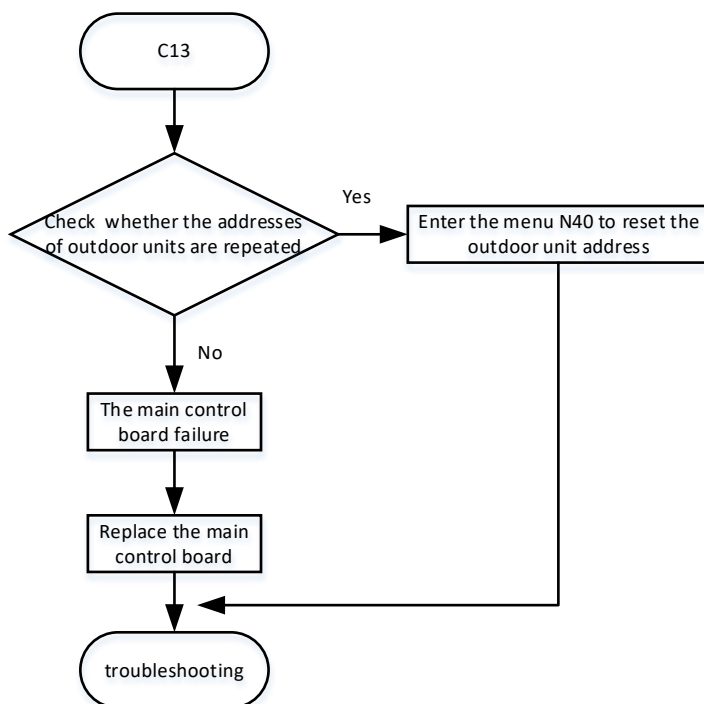

Notes:

After setting the outdoor unit address, waiting for 30 seconds then, powering off the device, next waiting another 30 seconds, and then powering on the device again. The master address must be set to 0

2.8 C21: Communication error between IDU and ODU.

2.8.1 Digital display output



2.8.2 Description

- Communication error between IDU and ODU
- All units stop running.
- Error code is only displayed on the master unit.

2.8.3 Trigger / recover condition

- Trigger condition: 20 minutes after the outdoor unit is power on, the communication signal from the IDU cannot be received by ODU for two minutes
- Recover condition: the ODU receives the communication signal from the IDU.
- Reset method: Resume automatically

2.8.4 Possible causes

(1) PQ communication is adopted

- The three-core shield cable is not in use or the shield layer is not grounded.
- The communication cable is not tightened or the surface contact of the wiring block is poor
- Communication cable is disturbed by strong electromagnetic wave
- The communication cable is disconnected or in bad contact due to various reasons
- Communication cables are not connected hand in hand or the PQE cable sequence is incorrect
- The address of an IDU is incorrect
- Indoor main control board is damaged.
- Outdoor main control board is damaged.

(2) M1M2 communication is adopted

- The communication cable is not tightened or the surface contact of the wiring block is poor
- Communication line is disturbed by strong electromagnetic wave
- The communication cable is disconnected or in bad contact due to various reasons
- The address of an IDU is incorrect
- Indoor main control board is damaged.
- Outdoor main control board is damaged.

[1] If Hyper-Link communication is used, the communication wire diameter should be 1.5mm²

[2] N45-2 IDUs uniform power supplied; N45-3-IDUs separate power supplied

2.8.5 Procedure

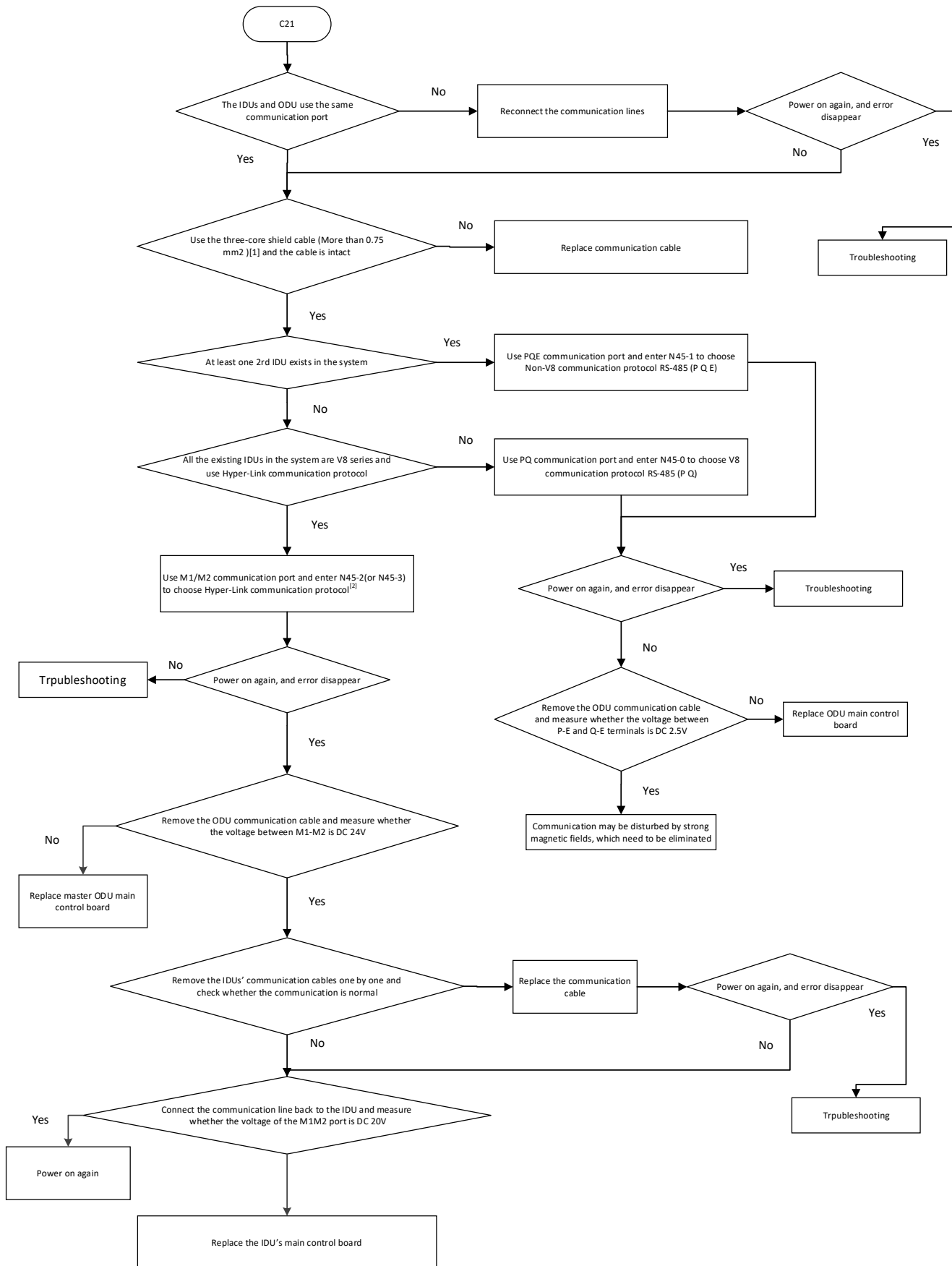

Note:

[1] If Hyper-Link communication is used, the communication wire diameter should be 1.5mm²

[2] N45-2 IDUs uniform power supplied; N45-3-IDUs separate power supplied

2.9 C26 Abnormal reduction in the number of indoor units

2.9.1 Digital display output



2.9.2 Description

- The number of online indoor units is smaller than the configured number
- All units stop running.
- Error code is only displayed on the master unit

2.9.3 Trigger / recover condition

- Trigger condition:
 - N0: The number of IDU set by ODU; N1: The number of online machines.
 - (1) During operation, $N1 < N0$ and lasts for 2 minutes
 - (2) After the first power-on, $N1 < N0$ within 20 minutes, ODU can not start starts and display that error
- Recover condition:
 - $N1 = N0$ for 60 seconds
- Reset method: Resume automatically

2.9.4 Possible causes

- The three-core shield cable is not in use or the shield layer is not grounded.
- The communication cable is not tightened or the surface contact of the wiring block is poor
- Communication cable is disturbed by strong electromagnetic wave
- The communication cable is disconnected or in bad contact due to various reasons
- Communication cables are not connected hand in hand or the PQE cable sequence is incorrect
- The address of an indoor unit is incorrect
- Indoor main control board is damaged.
- Outdoor main control board is damaged.
- The number of IDU set by ODU is inconsistent with the actual number of IDU

2.9.5 Procedure

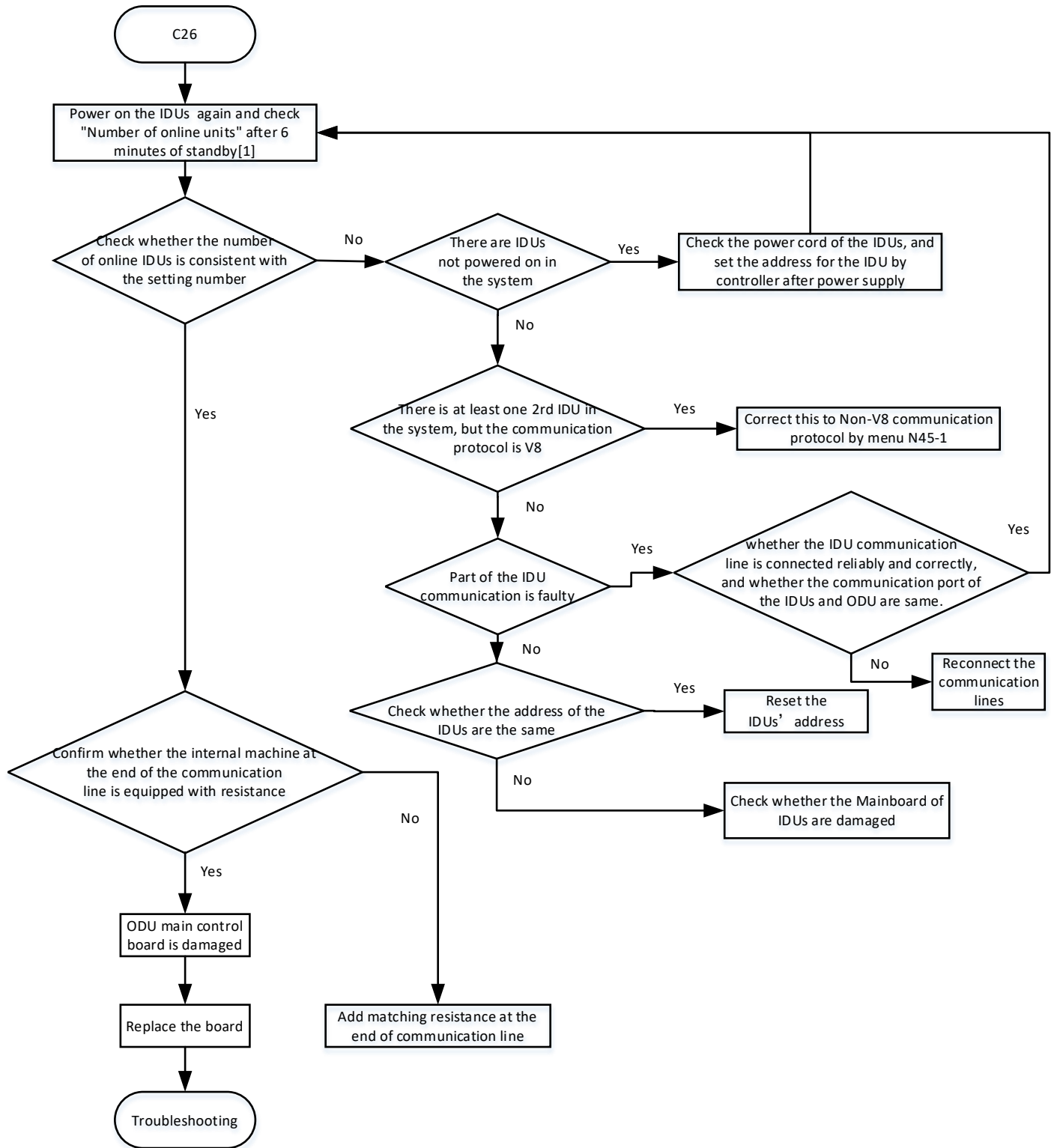

Note:

[1] Check the Number of indoor units (set by master unit) refer to the **Part 4 - 4.4.1**

2.10 C28: Abnormal increase in the number of indoor units

2.10.1 Digital display output



2.10.2 Description

- Abnormal increase in the number of indoor units
- All units stop running.
- Error code is only displayed on the master unit

2.10.3 Trigger / recover condition

- Trigger condition:
 - N0: The number of IDU set by ODU; N1: The number of online machines.
 - (1) During operation, $N1 > N0$ and lasts for 2 minutes
 - (2) After the first power-on, $N1 > N0$ within 20 minutes, ODU can not start starts and display the error
- Recover condition:
 - $N1 = N0$ for 60 seconds
- Reset method: Resume automatically.

2.10.4 Possible causes

- The three-core shield cable is not in use or the shield layer is not grounded.
- The communication cable is not tightened or the surface contact of the wiring block is poor
- Communication cable is disturbed by strong electromagnetic wave
- The communication cable is disconnected or in bad contact due to various reasons
- Communication cables are not connected hand in hand or the PQE cable sequence is incorrect
- The address of an indoor unit is incorrect
- Indoor main control board is damaged.
- Outdoor main control board is damaged.
- The number of IDU set by ODU is inconsistent with the actual number of IDU

2.10.5 Procedure

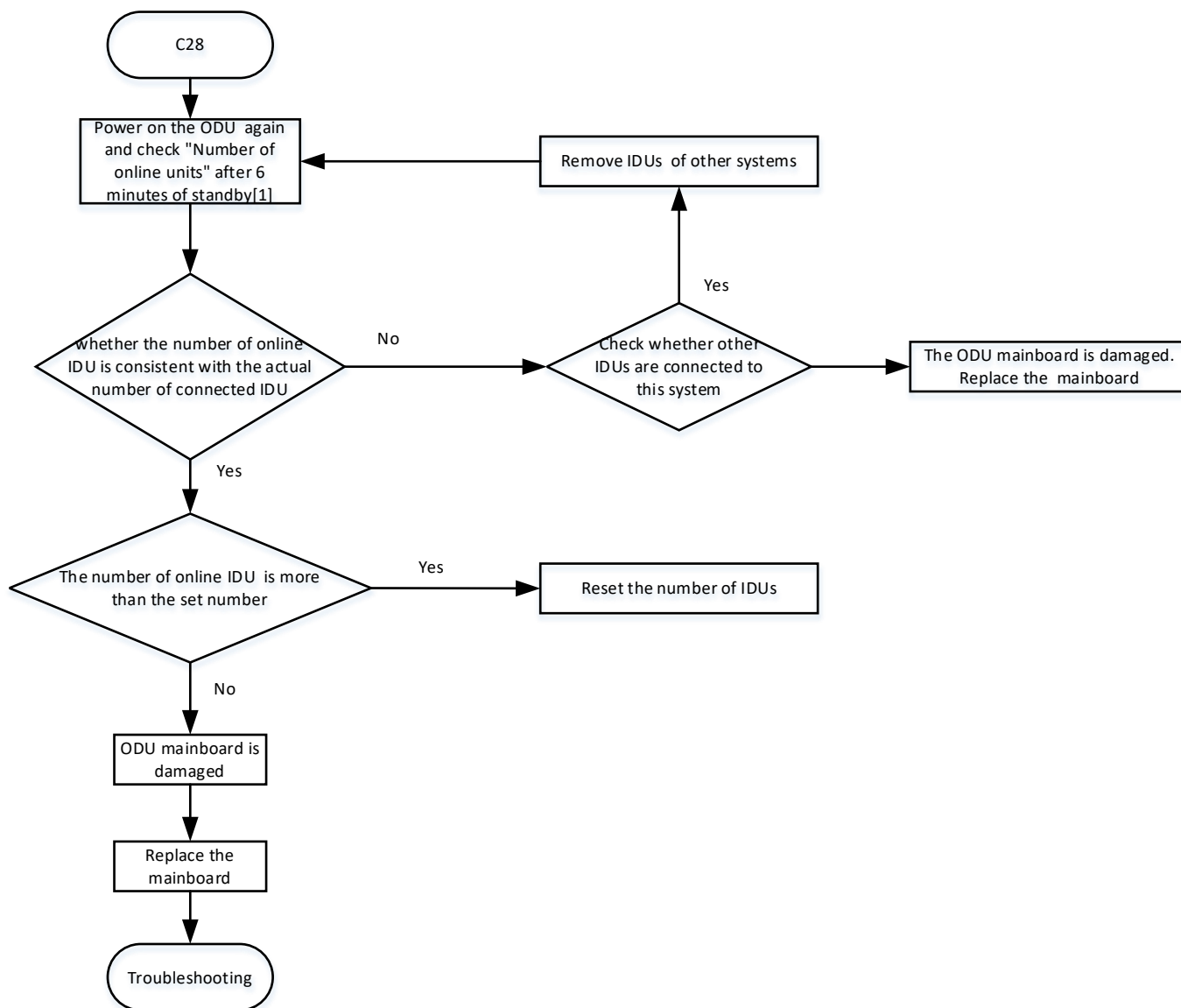

Note:

[1] Check the Number of indoor units (set by master unit) refer to the *Part 4 - 4.4.1*

2.11 xC31: Communication error between No.x slave outdoor unit and master outdoor unit.

2.11.1 Digital display output



2.11.2 Description

- The No.x outdoor slave unit cannot communicate with the outdoor master unit.
- All units stop running.
- Error code is only displayed on the slave unit with the error.

2.11.3 Trigger / recover condition

- Trigger condition: The communication between the slave unit and the master unit of the Combined system is interrupted for more than 2 minute
- Recover condition: The communication between the slave unit and the master unit of the Combined system is restored
- Reset method: Power off the device for 30 seconds and then power it on again

2.11.4 Possible causes

- Communication cables are not tightened on the wiring block
- The surface of the wiring block is corroded
- The outdoor unit address is incorrectly set
- Outdoor main control board is damaged

2.11.5 Procedure

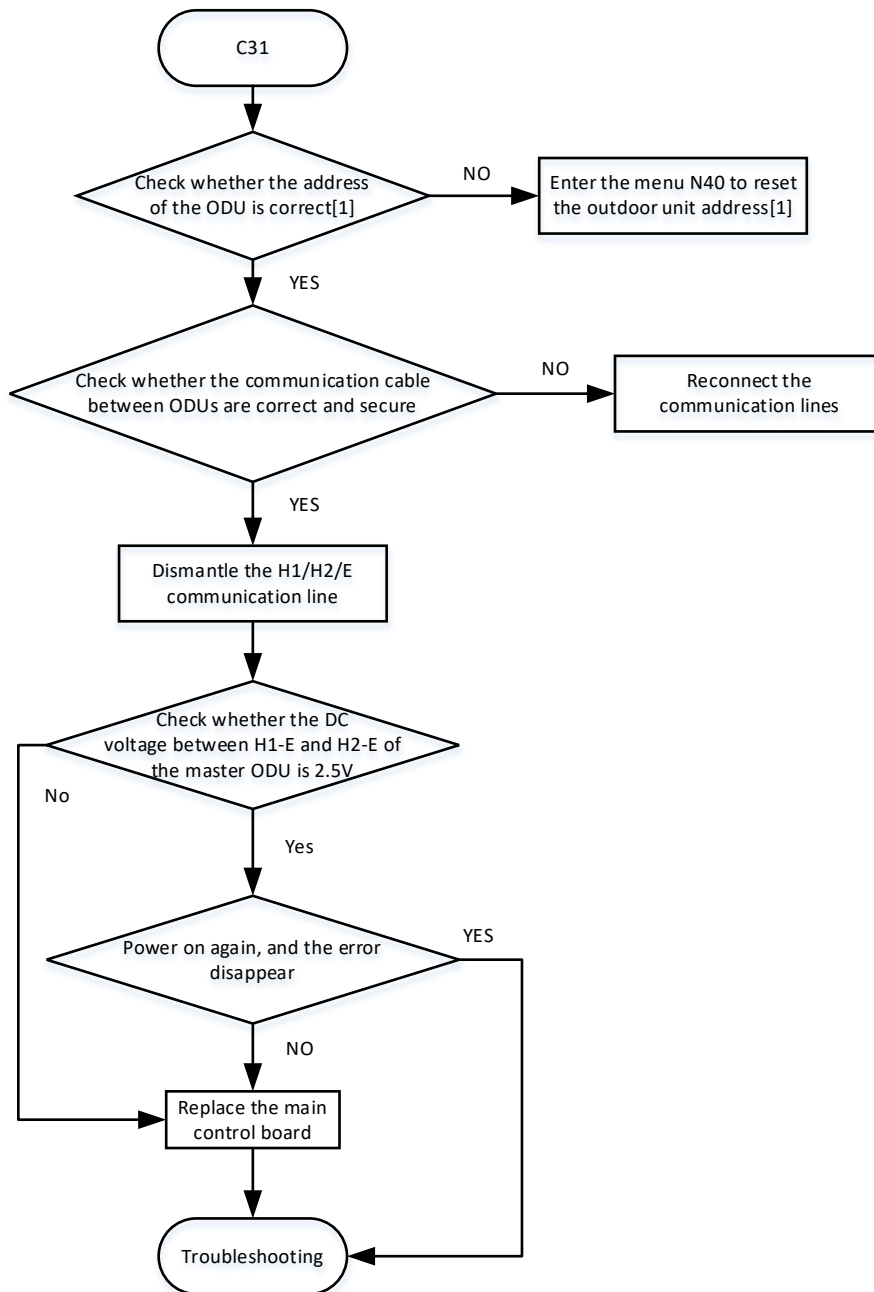

Note:

[1]The master is 0, and the slave is 1-3

2.12 C32: Abnormal reduction in the number of outdoor units

2.12.1 Digital display output



2.12.2 Description

- The number of online slave outdoor units detected by the master outdoor unit decreases
- All units stop running.
- Error code is only displayed on the master unit

2.12.3 Trigger / recover condition

- Trigger condition: The number of online outdoor slave units detected by the outdoor master unit decreases
- Recover condition: The number of outdoor units recovers
- Reset method: Resume automatically

2.12.4 Possible causes

- Some outdoor slave units are powered off
- The outdoor units' address are repeated
- The outdoor unit address is false.
- Outdoor main control board is damaged
- The H1/H2 cable sequence is incorrect
- Outdoor Units do not support Combined connection

2.12.5 Procedure

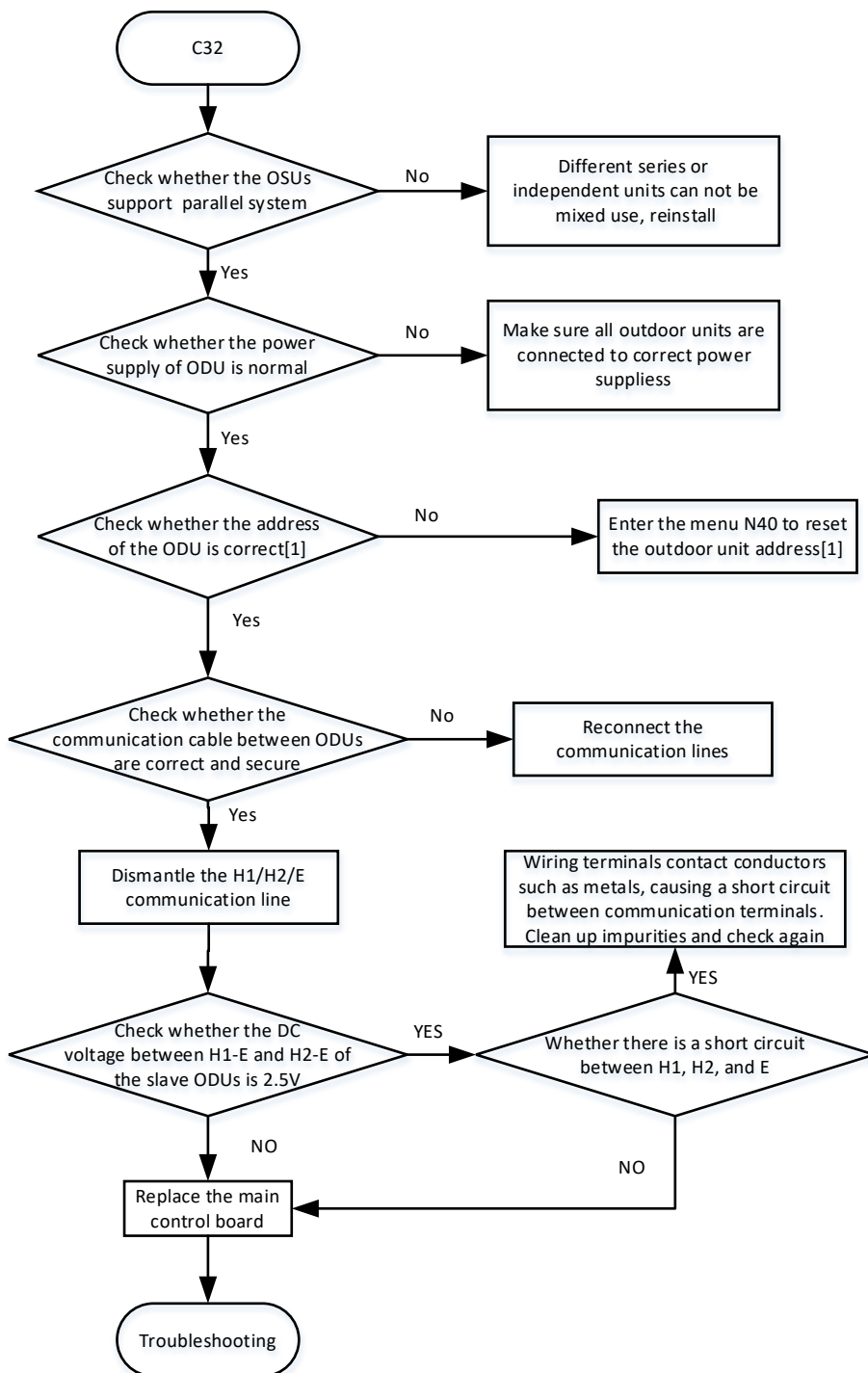

Note:

[1]The master is 0, and the slave is 1-3

2.13 C33: Abnormal increase in the number of outdoor units

2.13.1 Digital display output



2.13.2 Description

- The number of online outdoor slave units detected by the outdoor master unit increases
- All units stop running.
- Error code is only displayed on the master unit

2.13.3 Trigger / recover condition

- Trigger condition: One or more slave Outdoor unit is newly connected during system operation
- Recover condition: Check the system connection status and power on the system again
- Reset method: Resume manually

2.13.4 Possible causes

- The number of outdoor unit increases (One or more slave outdoor units newly Join Combined system)
- Set the outdoor unit address correctly if it is repeated or incorrect.

2.13.5 Procedure

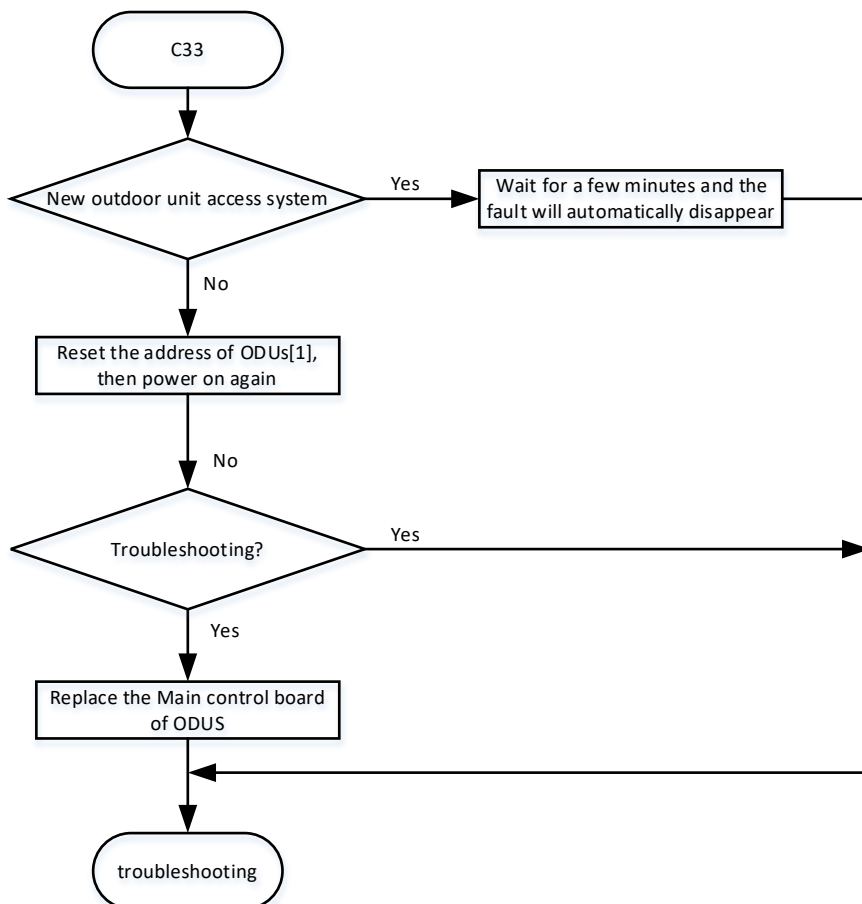

Note:

[1]The master is 0, and the slave is 1-3

2.14 xC41: Communication Error between main control board and No.x inverter driver board

2.14.1 Digital display output



2.14.2 Description

- The communication between the main control board and No.x inverter driver board is error
- All units stop running.
- Error code is displayed on the unit with the error

2.14.3 Trigger / recover condition

- Trigger condition: Communication between main control board and No.x inverter driver board is interrupted for more than 2 minutes
- Recover condition: Communication between the main control board and No.x inverter driver board is restored
- Reset method: Resume automatically.

2.14.4 Possible causes

- Communication between main control board and No.x inverter driver board is interrupted
- No.x inverter driver board is damaged
- Main control board is damaged

2.14.5 Procedure

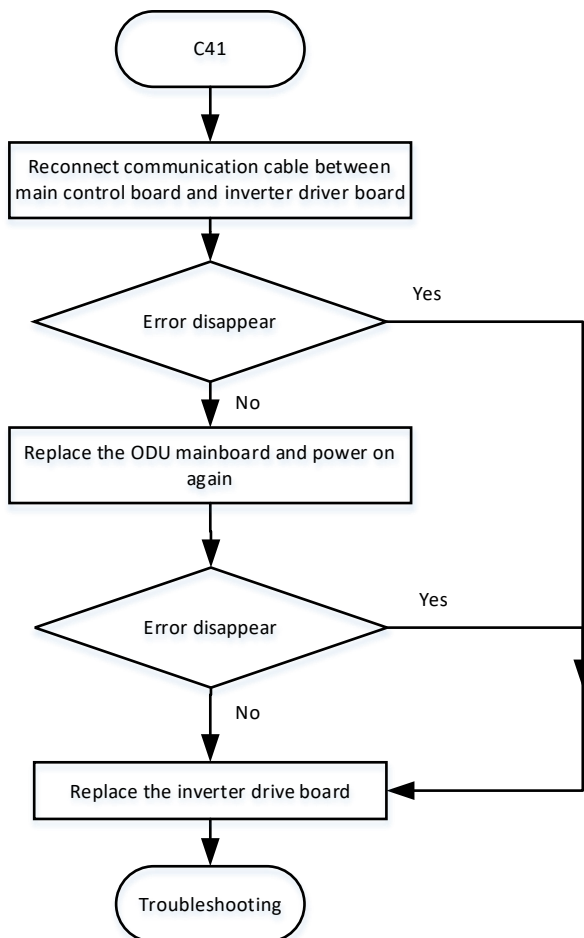

2.15 E41,F31,F41,F51,xF71,F81,F91,FA1,FC1,xFd1,Fp1: Temperature sensor error
2.15.1 Digital display output

Error code	Error description	Remarks	Digital display output
E41	Outdoor ambient temperature sensor (T4) error(open/short)	sensor error	
F31	Microchannel heat exchanger outlet temperature sensor(T6B) error(open/short)	sensor error	
F41	Main heat exchanger pipe temperature sensor (T3) error(open/short)	sensor error	
F51	Microchannel heat exchanger inlet temperature sensor(T6A) error(open/short)	sensor error	
xF71	Discharge temperature sensor(T7C1/T7C2) error (open/short)	sensor error	
F81	Gas pipe temperature sensor (Tg) error (open/short)	sensor error	
F91	Liquid pipe temperature sensor (T5) error (open/short)	sensor error	
FA1	Outdoor Heat exchanger gas temperature sensor (T8) error (open/short)	sensor error	
FC1	Outdoor heat exchanger liquid temperature sensor (TL) error (open/short)	sensor error	
xFd1	Compressor suction temperature sensor (T71/T72) error (open/short)	sensor error	
Fp1	Electric control box chamber temperature sensor (Tb) error (open/short)	sensor error	

2.15.2 Description

- All units stop running.
- Error code is displayed on the unit with the error Trigger / recover condition

2.15.3

- Trigger condition: The main control board cannot obtain the normal AD value of the temperature sensor
- Recover condition: The main control board obtain the normal AD value of the temperature sensor
- Reset method: Resume automatically.

2.15.4 Possible causes

- The temperature sensor is not properly connected to the main control board.
- Sensor failure
- The main control board is damaged

2.15.5 Procedure

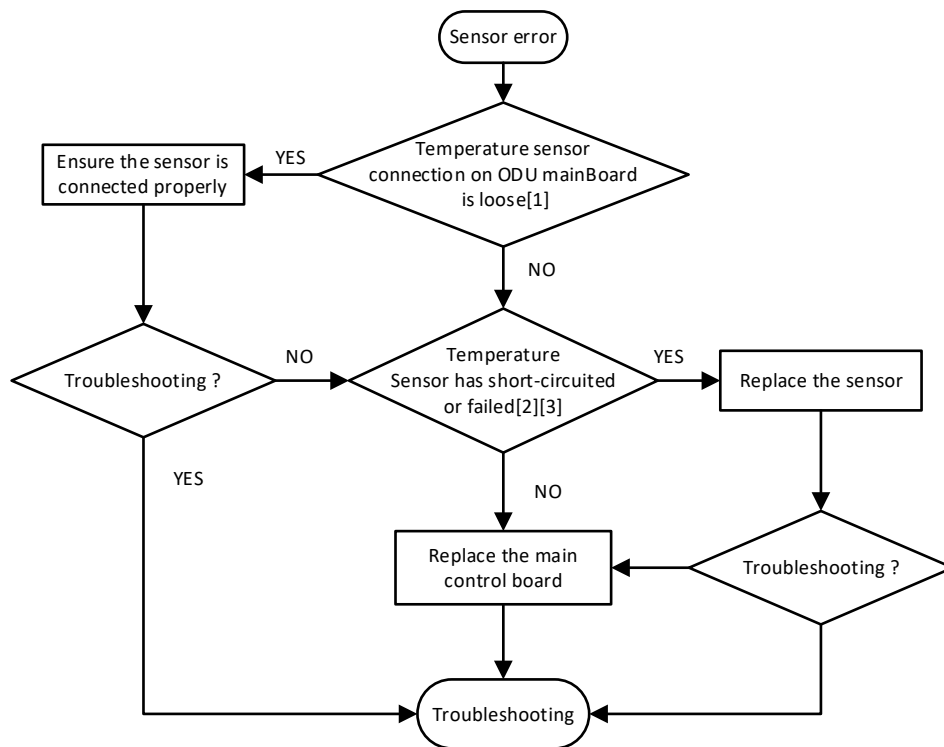

Notes:

[1]. The port on the main control board corresponding to the Temperature sensor refer to *Table 5.3.1: Main Control Board port definition Table*.

[2]. Measure sensor resistance. Removing the sensor and Use a multimeter to measure the sensor access resistance: If the resistance value is smaller than 0.5 kΩ (T7C1/T7C2 is 0.97 kΩ), the sensor is short-circuited, whereas, if the impedance is very higher than 380 kΩ (T7C1/T7C2 is 743 kΩ), the sensor is open-circuited (Refer to *Table 5.1.1: Temperature sensor temperature resistance characteristic table*)

[3]. Measure the voltage of the port on main control board. If the sensor resistance is normal, then use a multimeter to measure the port voltage: If the port voltage is not 3.3V with main control board is powered on, the main control board is damaged and needs to be replaced.

2.16 F62, F6A: Inverter driver board NTC overtemperature protection

2.16.1 Digital display output

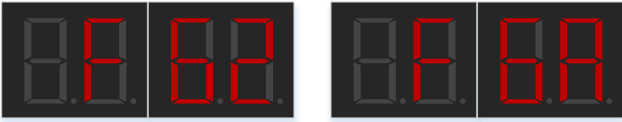

2.16.2 Description

- All units stop running
- Error code is displayed on the unit with the error.

2.16.3 Trigger/ Recover condition

- Trigger condition:
 - F62: The NTC temperature inside the compressor board or fan module is higher than 100 ° C
 - F6A: F62 protection occurs 3 times in 100 minutes
- Recover condition: The NTC temperature is lower than 80 ° C
- Reset method:
 - F62: Resume automatically
 - F6A: Manually restart

2.16.4 Possible causes

- Inverter driver board is in poor contact with the radiator
- The thermal grease layer is missing
- Inverter driver board is damaged

2.16.5 Procedure

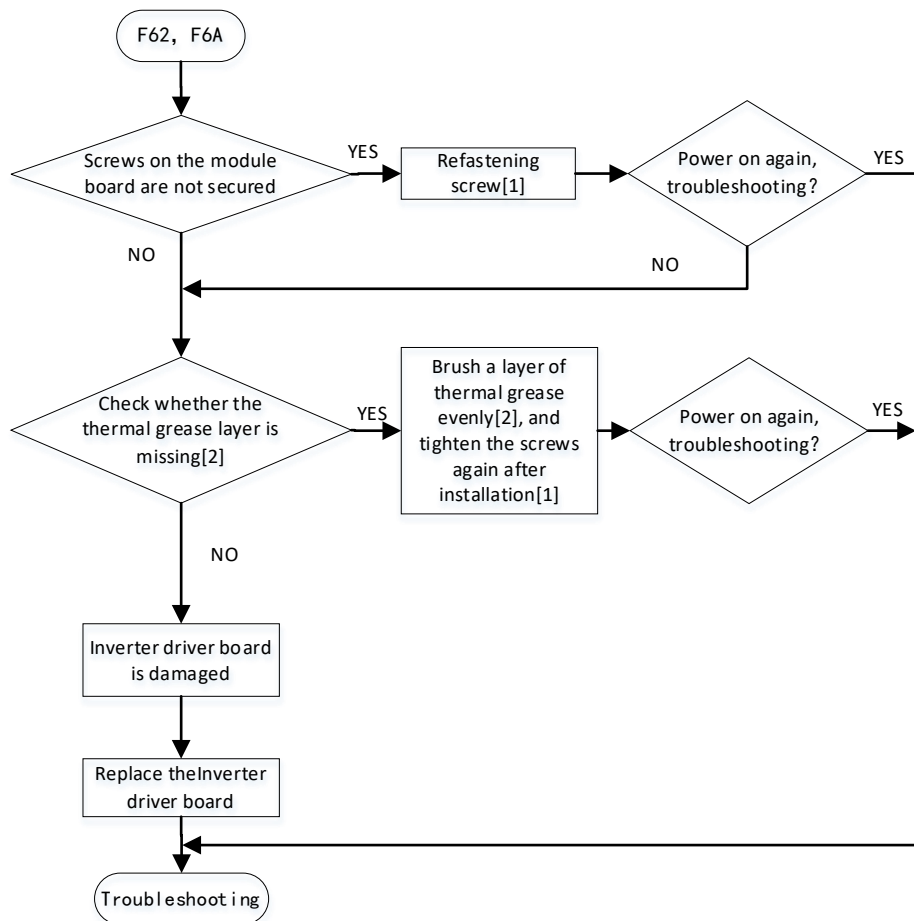

Notes:

[1] Reinstall the Inverter driver board refer to **Part 5 -3.5 The installation guide of Compressor & Fan drive board**

[2]The thermal grease layer is located between the Inverter driver board and the radiator, and the thickness is about 0.2 mm.If the thermal grease layer is in poor condition, it is easy to lead to poor heat dissipation effect. You need to clean it and fill it again

2.17 F63: Non-inductive resistance Tr overtemperature protection

2.17.1 Digital display output

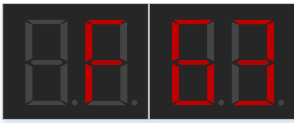

2.17.2 Description

- All units stop running
- Error code is displayed on the outdoor unit with the Error

2.17.3 Trigger/ Recover condition

- Trigger condition: The non-inductive resistance temperature exceeds 95 ° C
- Recover condition: The non-inductive resistance temperature is lower than 70 ° C
- Reset method: Resume automatically

2.17.4 Possible causes

- The Recirculation Fan in the electric control box works improperly(Top Flow Series)
- The air intake grille at the bottom of the machine or the internal air duct is blocked(Side Flow Series)
- Inverter driver board is damaged

2.17.5 Procedure

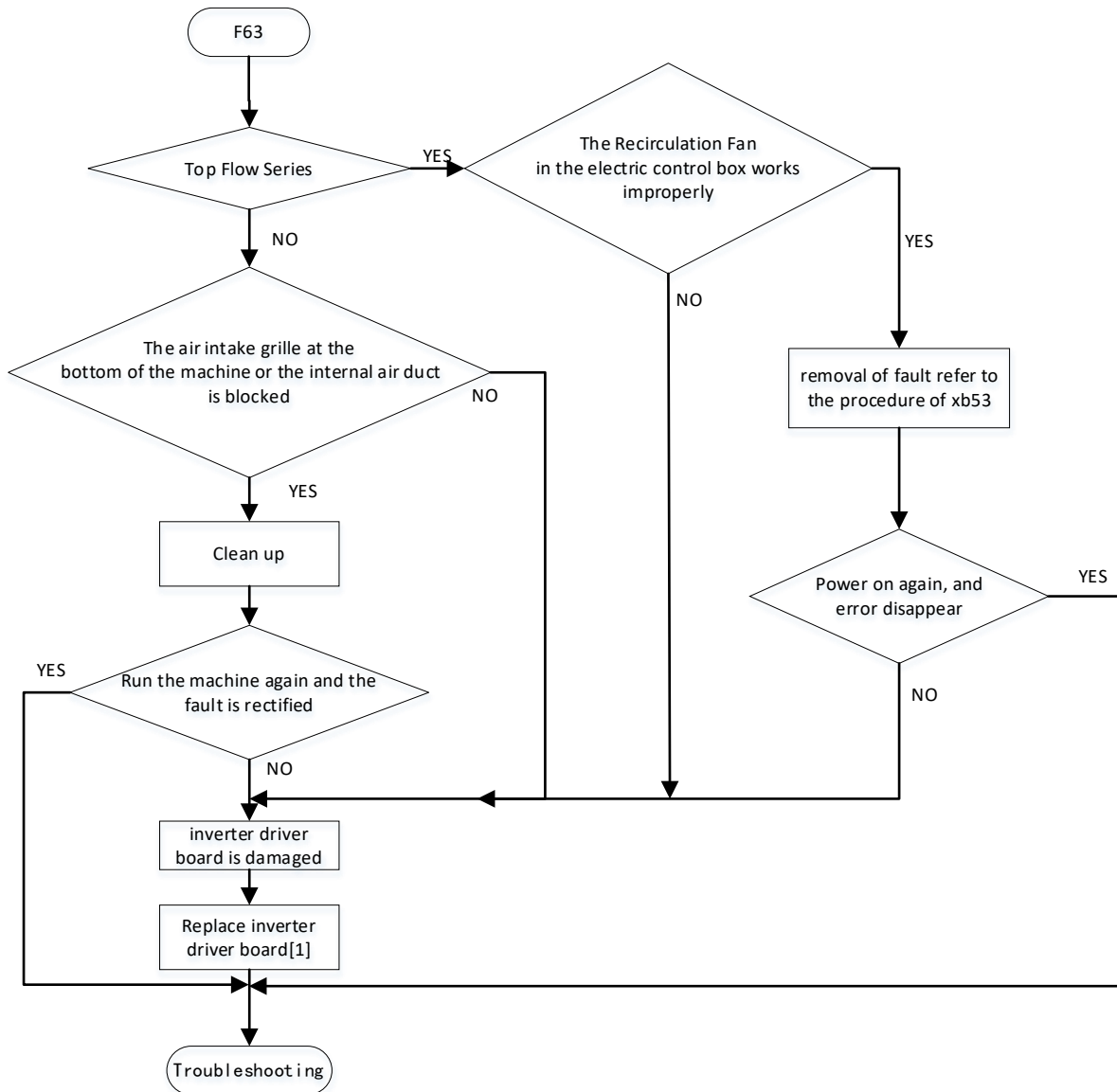

Notes:

[1]. Reinstall the Inverter driver board refer to **Part 5-3.5** *The installation guide of Compressor & Fan drive board*

2.18 F72, F7A: Discharge Temperature protection

2.18.1 Digital display output



2.18.2 Description

- Discharge Temperature is over the limit.
- All outdoor Unit stop running
- Error code is displayed on the unit with the error

2.18.3 Trigger / Recover condition

- Trigger condition:
 - F72: Discharge Temperature (T7C1/T7C2) $\geq 115^{\circ}\text{C}$.
 - F7A:F72 protection occurs 3 times in 100 minutes
- Recover condition: Discharge Temperature (T7C1/T7C2) $< 90^{\circ}\text{C}$.
- Reset method:
 - F72: Resume automatically
 - F7A: Manually restart

2.18.4 Possible causes

- The discharge temperature sensor temperature failure
- Main control board is damaged
- The discharge temperature sensor temperature is too high

2.18.5 Procedure

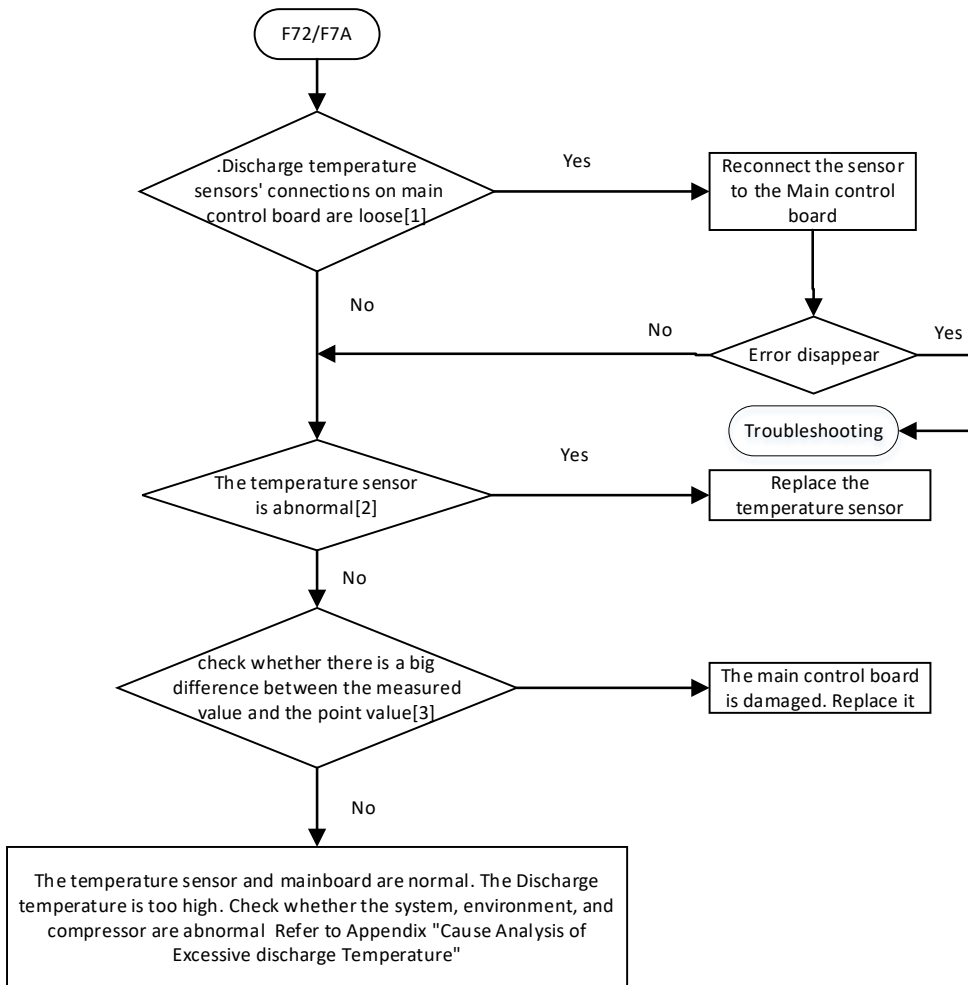

Notes:

[1] The main control board port of Discharge temperature sensor 1 (T7C1) is CN4 and Discharge temperature sensor 2(T7C2) is CN38:

[2] Measure sensor resistance. If the resistance is too low, the sensor has short-circuited. If the resistance is not consistent with the sensor's resistance characteristics table, the sensor has failed. Refer to "Table 5.1.1: Temperature sensor temperature resistance characteristic table"

[3] Use the temperature measuring tool to measure the Discharge temperature. Less refrigerant system results in higher Discharge temperature of the compressor, lower Discharge and suction pressure, lower current, and frost on the gas return pipe. These phenomena disappear when the system is replenished with normal refrigerant. Refer to Table 5.2.1 and 5.2.2 "Normal Refrigerant System parameters" in Chapter 5 for normal system parameters.

2.19 F75: Compressor discharge insufficient superheat protection

2.19.1 Digital display output

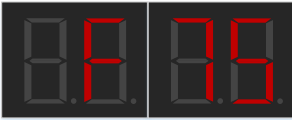

2.19.2 Description

- Superheat degree of Compressor discharge temperature is too low, triggering protection shutdown
- Determination during operation of outdoor unit.
- All units stop running.
- The error code is displayed on the outdoor unit with error.

2.19.3 Trigger / recover condition

- Trigger condition: During the system operation, the discharge superheat of the compressor is lower than 6 ° C and lasts for more than 90 minutes
- Recover condition: Resume automatically after 30 seconds of downtime
- Reset method: Resume automatically

2.19.4 Possible causes

- Temperature sensor not connected properly or has malfunction.
- High pressure sensor not connected properly or has malfunction.
- Excess refrigerant.
- Some valves of ODU can't be fully closed.
- Some valves of IDU can't be fully closed.
- Outdoor main control board damaged.

2.19.5 Procedure

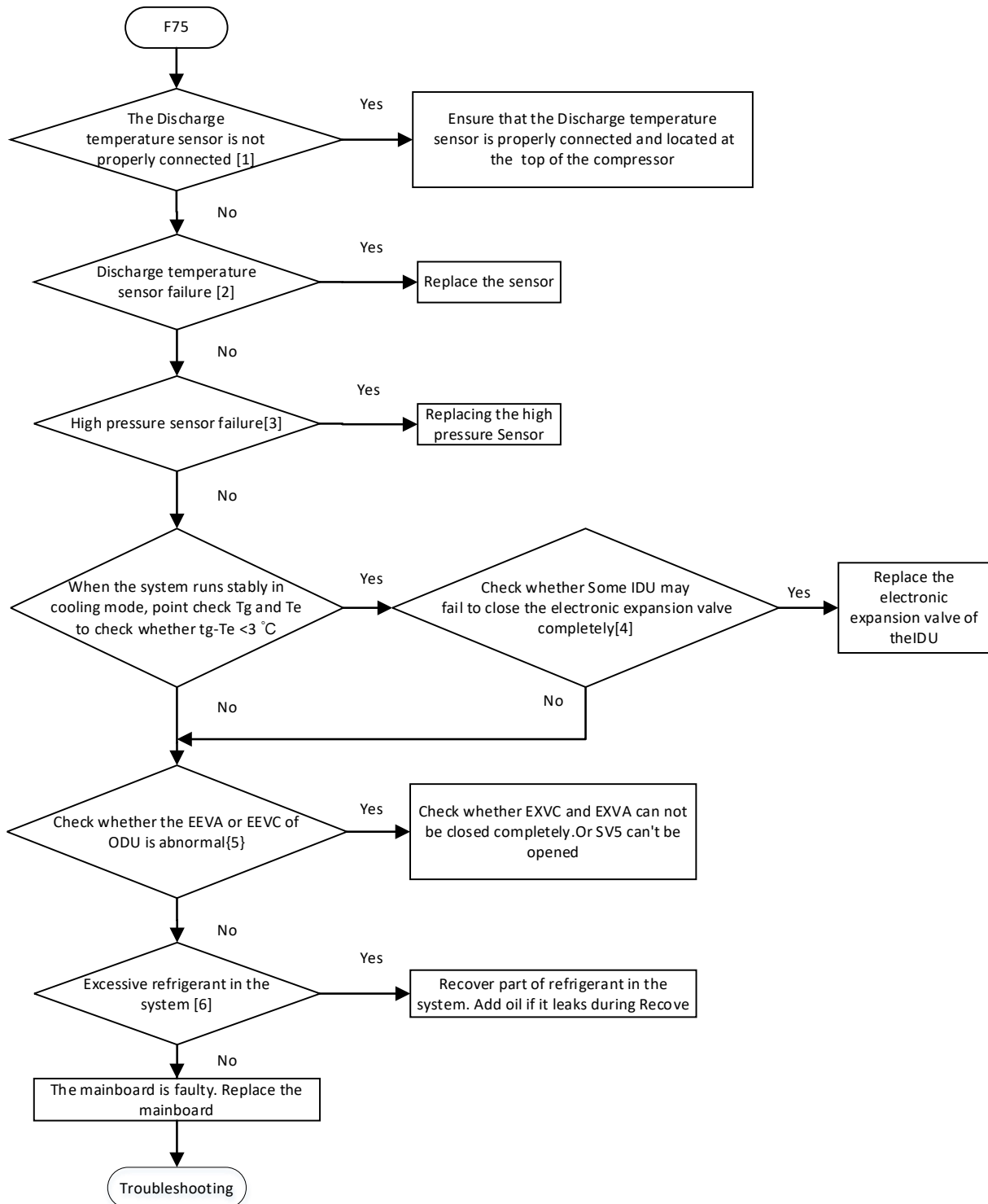

Notes:

[1] The main control board port of Discharge temperature sensor 1 (T7C1) is CN4 and Discharge temperature sensor 2(T7C2) is CN38:

[2] Measure sensor resistance. If the resistance is too low, the sensor has short-circuited. If the resistance is not consistent with the sensor's resistance characteristics table, the sensor has failed. Refer to Table 6-4.2 in Part 6, 4.1 "Temperature Sensor Resistance Characteristics"

[3] Measure the resistance among the three terminals of the pressure sensor. If the resistance is of the order of mega Ohms or infinite, the pressure sensor has failed.

[4] Close the IDU and check whether the temperature of the Gas pipe is too low or frosted or the evaporator is frosted

[5] If the following happens the EEVA or EEVC of ODU is abnormal

1. $T6B-T6A < 3^{\circ}\text{C}$ and $T6A-Te < 3^{\circ}\text{C}$ when EEVC minimum opening (0pls or 17pls)?

2. $T8 -Te < 2^{\circ}\text{C}$ when EEVA minimum opening (0pls or 17pls) in heating mode?

[6] Excess refrigerant causes discharge temperature to be lower than normal, discharge pressure to be higher than normal and suction pressure to be higher than normal. Normal system parameters refer to Table 5.2.1 and 5.2.2 "Normal Refrigerant System Parameters" in Chapter 5.

2.20 P11: High pressure sensor error

2.20.1 Digital display output



2.20.2 Description

- Open/short circuit error of high pressure sensor
- All units stop running.
- The error code is displayed on the Outdoor Unit with error.

2.20.3 Trigger / recover condition

- Trigger condition: The main control board cannot obtain the normal AD value of the high pressure sensor
- Recover condition: The main control board can obtain the normal AD value of the high pressure sensor
- Reset method: Resume automatically.

2.20.4 Possible causes

- The high-pressure sensor is not properly connected to the main control board, or it fails.
- The main control board is damaged

2.20.5 Procedure

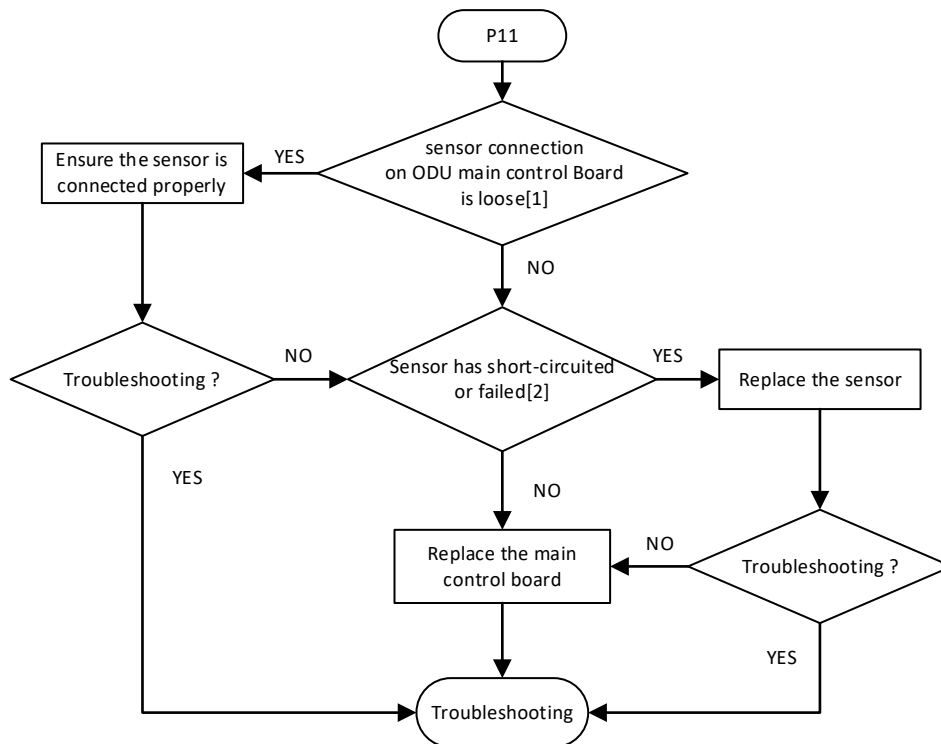

Notes:

[1] The ports on the main control board corresponding to the high-pressure sensor are CN40, please refer to **Table 5.3.1: Main Control Board port definition Table**.

[2]. Measure the voltage of the CN40 port. If the sensor is normal, use a multimeter to measure the port voltage; After the main control board is powered on, if the port voltage is not 3.3V, the main control board is damaged and needs to be replaced.

2.21 P12/P14:High pressure protection

2.21.1 Digital display output



2.21.2 Description

- P12: The high pressure is over the limit.
- P14: 3 times P12 in 100 minutes
- All units stop running
- Error code is displayed on the unit with the Error

2.21.3 Trigger / recover condition

- Trigger condition:
 - P12: discharge pressure \geq 4.15 MPa.
 - P14: P12 occurs 3 times within 100 minutes
- Recover condition:
 - P12: Cooling mode: discharge pressure < 3.5MPa
Heating mode: discharge pressure < 3.1MPa
 - P14: Remove high pressure protection from Outdoor Unit
- Reset method:
 - P12: Resume automatically.
 - P14: Resume manually

2.21.4 Possible causes

- Outdoor unit stop valves are closed.
- Pressure sensor/switch not connected properly or has malfunction.
- Poor condenser heat exchange.
- Outdoor main control board damaged.
- Refer to Appendix "Cause Analysis of Excessive Discharge Pressure".

2.21.5 Procedure

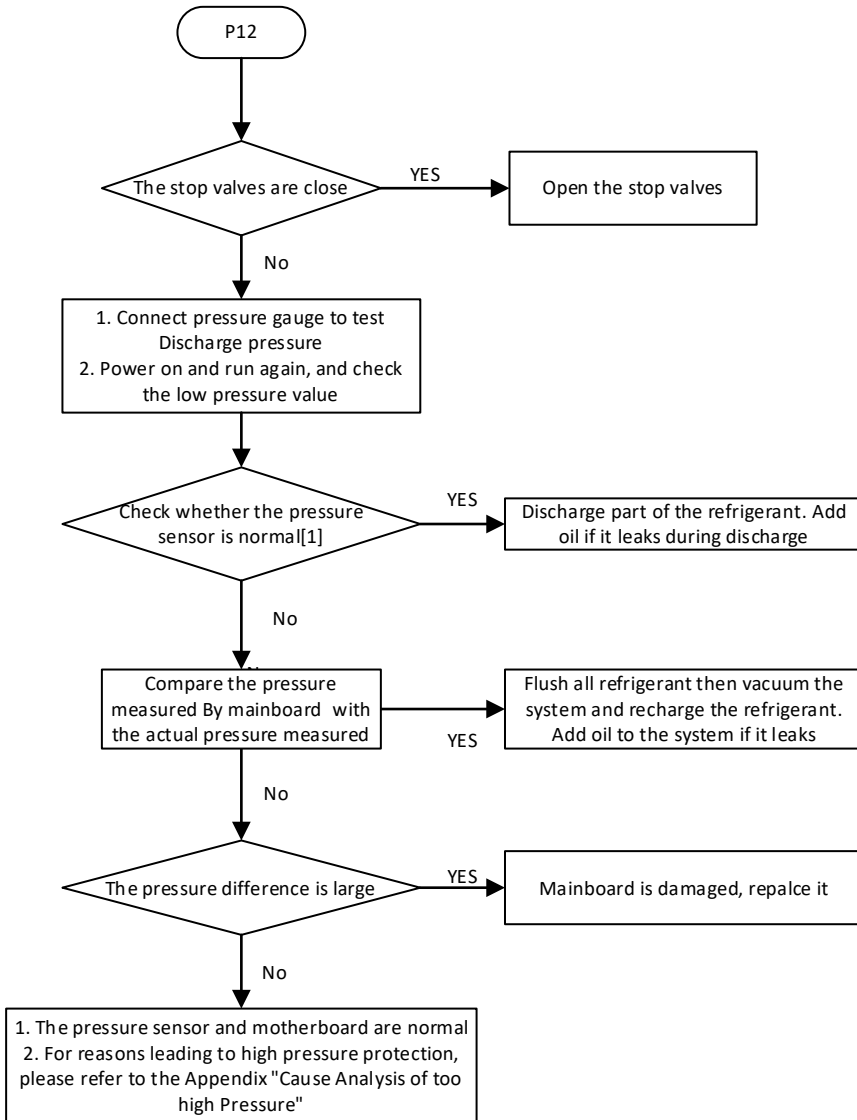

Note:

[1] The high voltage sensor port is connected to the Outdoor Unit main control board port CN40

[2] Measure the resistance between the three terminals of the pressure sensor.If the resistance is megohm or infinite, the pressure sensor fails

2.22 P13: High pressure switch protection

2.22.1 Digital display output



2.22.2 Description

- All units stop running
- Error code is displayed on the unit with the Error

2.22.3 Trigger / recover condition

- Trigger condition: discharge pressure ≥ 4.2 MPa.
- Recover condition: discharge pressure < 3.0
- Reset method: Resume automatically.

2.22.4 Possible causes

- Outdoor unit stop valves are closed.
- Pressure switch not connected properly or has malfunction.
- Excess refrigerant.
- System contains air or nitrogen.
- High pressure side blockage.
- Poor condenser heat exchange.
- Outdoor main control board damaged.

2.22.5 Procedure

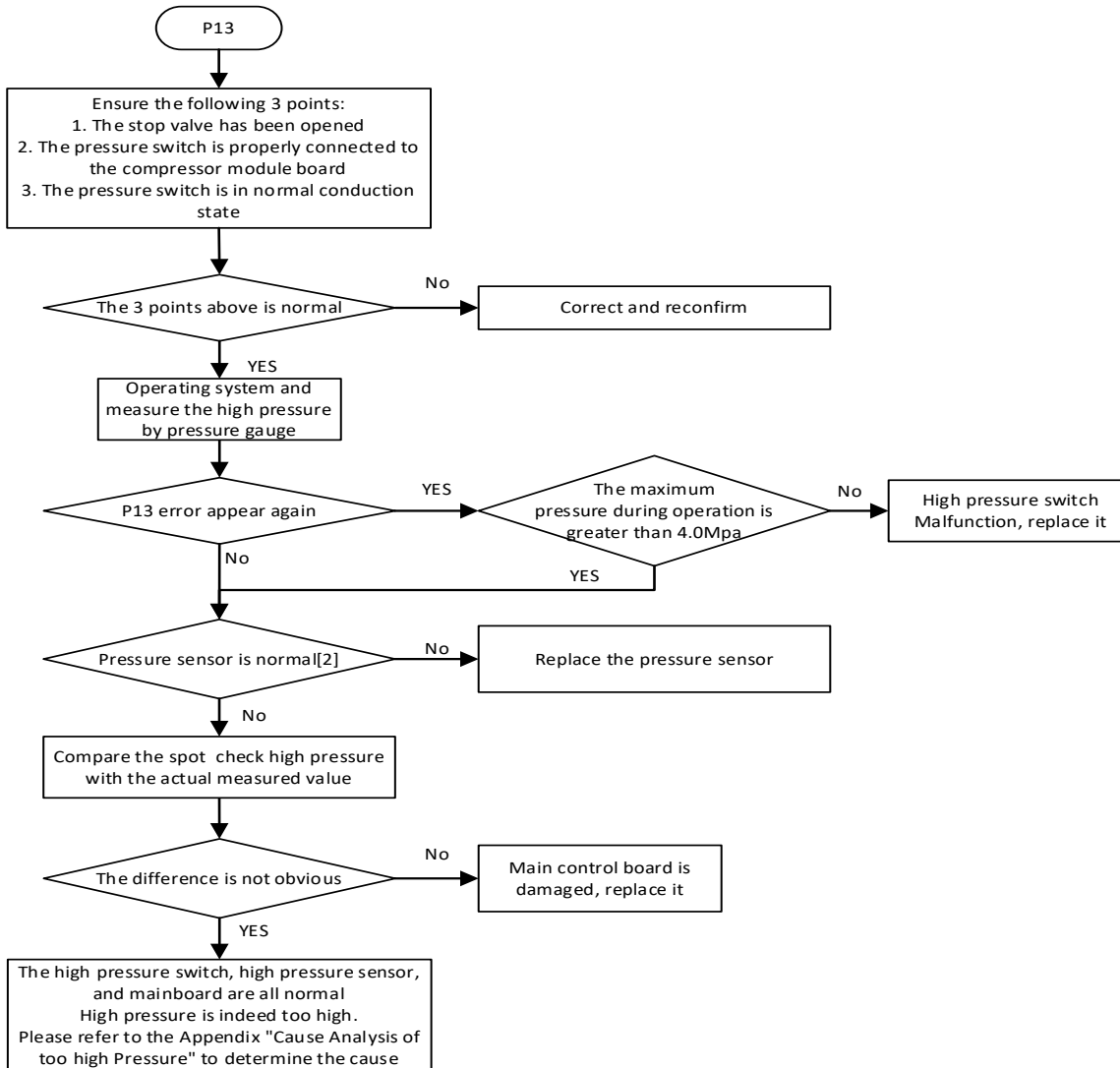

Note:

1. The High pressure switch port is connected to the Outdoor Unit Inverter driver board port CN21
2. To check whether the pressure sensor is abnormal, refer to the Appendix "Pressure Sensor Detection"

2.23 P21: Low pressure sensor error

2.23.1 Digital display output



2.23.2 Description

- Open/short circuit Error in suction pressure sensor
- All units stop running.
- Error code is only displayed on the slave unit with the error.

2.23.3 Trigger / recover condition

- Trigger condition: Abnormal values of the low-pressure sensor have been detected for 2 consecutive minutes
- Recover condition: Rectify the Error of the low-voltage sensor and power it on again
- Reset method: power it on again

2.23.4 Possible causes

- Suction pressure sensor has poor contact or it is damaged
- main control board is damaged
- The low pressure sensor is inversely connected to the high pressure sensor

2.23.5 Procedure

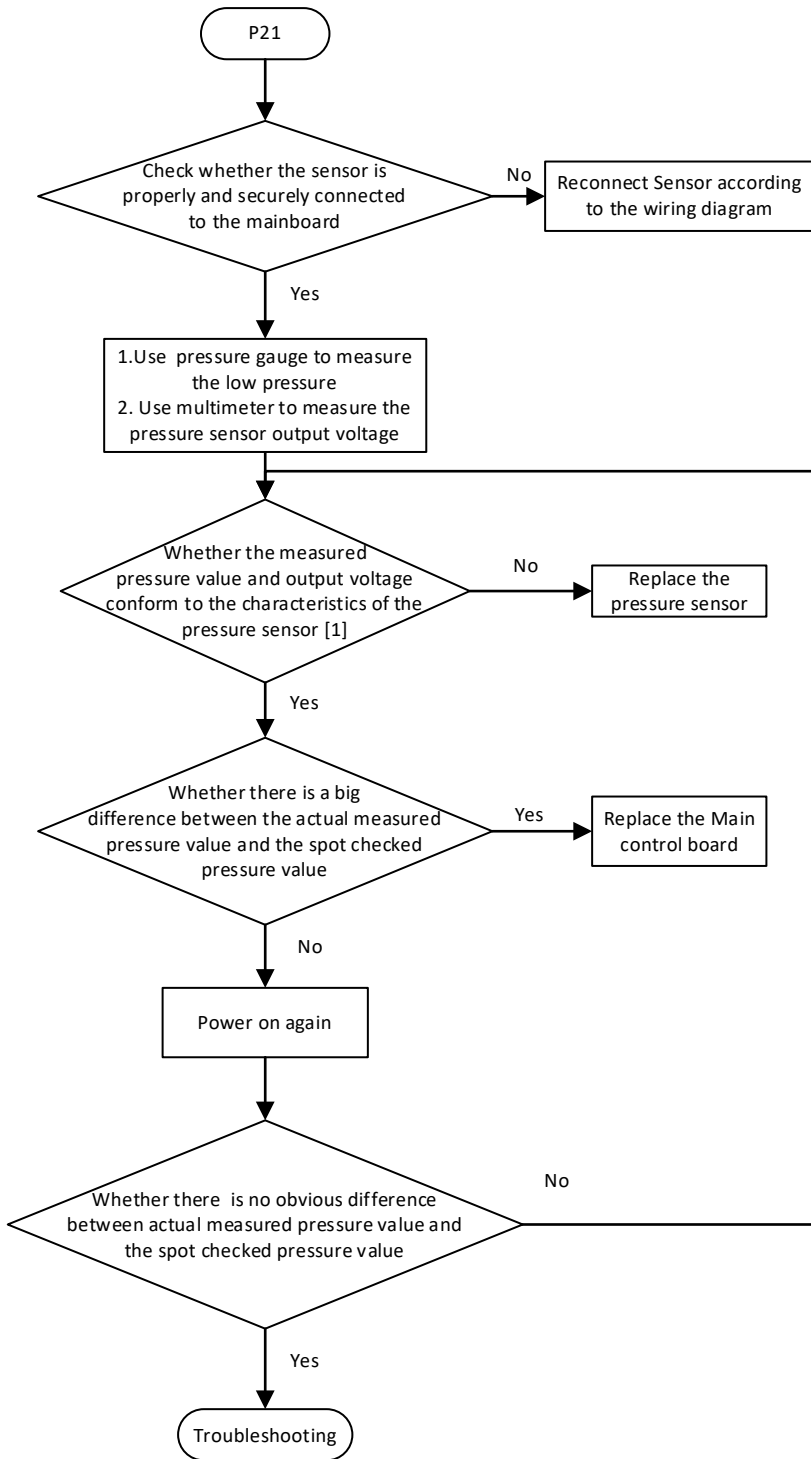

Note:

1. To check whether the pressure sensor is abnormal, refer to the Appendix "Pressure Sensor Detection".

2.24 P22, P25: Low pressure protection

2.24.1 Digital display output



2.24.2 Description

- All units stop running.
- Error code is displayed on the unit with the error.

2.24.3 Trigger/ Recover condition

- Trigger condition:
 - P22: suction pressure $< 0.07\text{MPa}$.
 - P25: P22 occurs 3 times within 60 minutes
- Recover condition: Suction pressure $> 0.15\text{MPa}$
- Reset method:
 - P22: Resume automatically
 - P25: Resume manually

2.24.4 Possible causes

- Outdoor unit stop valves are closed.
- Low pressure sensor is damaged
- Main control board of Outdoor Unit is damaged
- The actual pressure is too low

2.24.5 Procedure

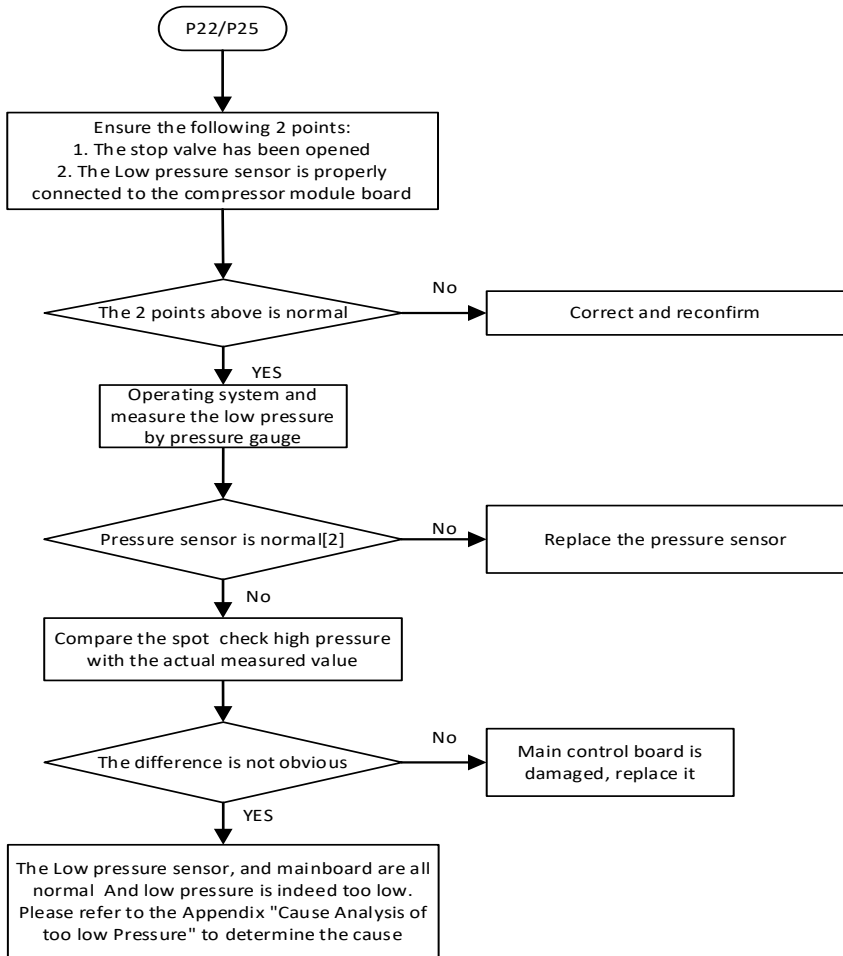

Note:

1. The low pressure sensor port is connected to the Outdoor Unit main control board port CN41
2. To check whether the pressure sensor is abnormal, refer to the Appendix "Pressure Sensor Detection".

2.25 P24: Abnormal elevation of low pressure

2.25.1 Digital display output



2.25.2 Description

- All units stop running.
- Error code is displayed on the unit with the error

2.25.3 Trigger/ Recover condition

- Trigger condition:
Suction pressure >1.6MPa and lasts 60 minutes
- Recover condition:
The ODU shutdown and resume automatically after 1 minute.
- Reset method:
Resume automatically

2.25.4 Possible causes

- Outdoor Unit out of range operation
- Main control board of Outdoor Unit is damaged

2.25.5 Procedure

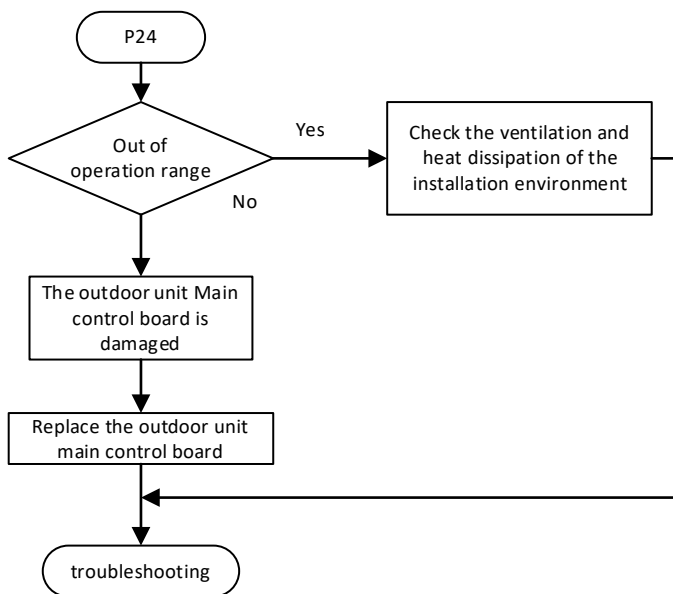

2.26 xP32, xP33: No.(x) compressor high DC bus current protection

2.26.1 Digital display output



2.26.2 Description

- The DC bus current of No.x compressor is too high, triggering protection shutdown
- All units stop running..
- Error code is displayed on the unit with the error.

2.26.3 Trigger / recover condition

- Trigger condition:
 - P32: During operation, the DC bus current of any compressor exceeds the upper limit
 - P33: Within 100min, No.x compressor appears P32 for 3 times
- Recover condition:
 - P32: The DC bus current of all compressors is lower than the recovery value
 - P33: After the device is powered on again, release the lock
- Reset method:
 - P32: Resume automatically
 - P33: Resume manually

2.26.4 Possible causes

- The compressor is overload
- The motor coil inside the compressor is damaged and short-circuited
- The high-pressure pipe side is blocked.
- The inverter module board is damaged

2.26.5 Procedure

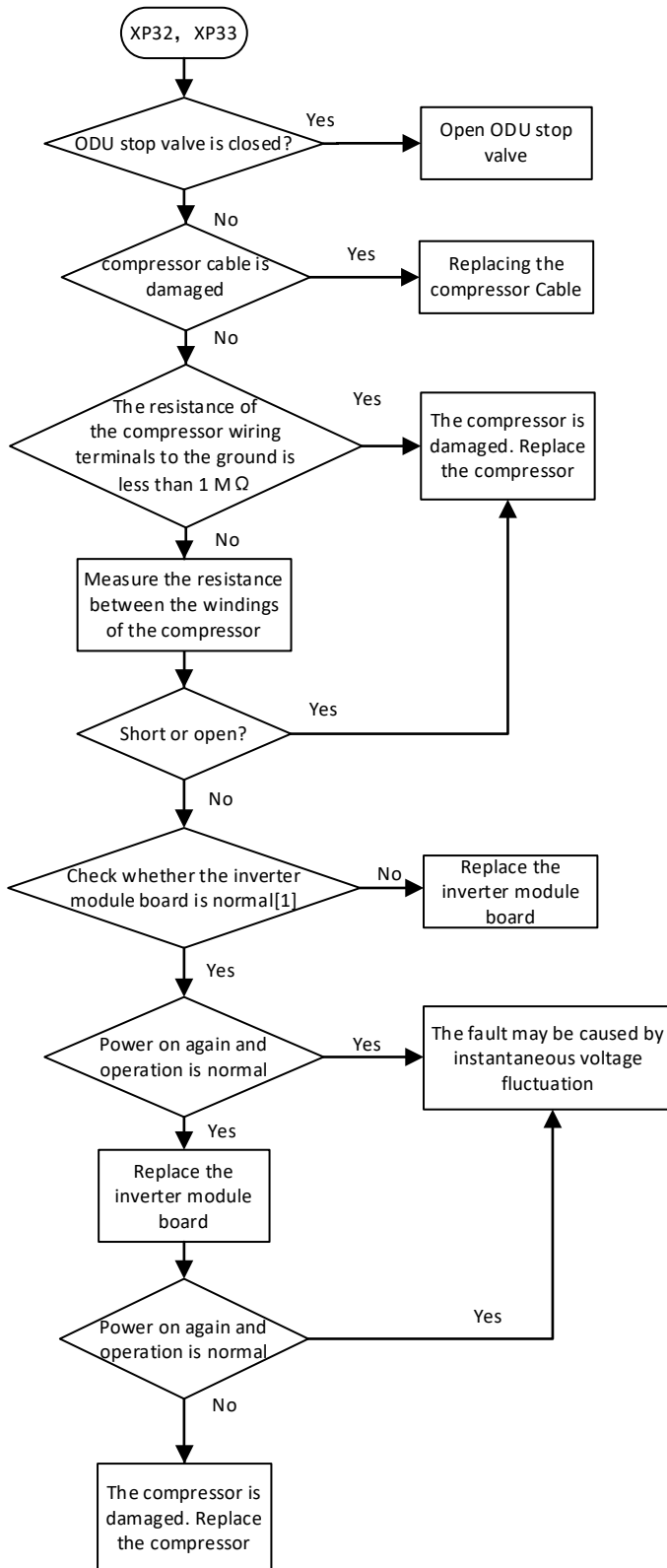

Note:

1. Refer to the Appendix "Measurement Guide for inverter Module Board".

2.27 P51: High AC voltage protection

2.27.1 Digital display output



2.27.2 Description

- The AC voltage of the system is too high, triggering the protection shutdown
- All units stop running
- Error code is displayed on the unit with the error.

2.27.3 Trigger / recover condition

- Trigger condition: The AC voltage of Outdoor Unit over 265 V
- Recover condition: Wait 7/15/30min for each occurrence, and the AC voltage of Outdoor Unit drops below 250 V
- Reset method: Resume automatically.

2.27.4 Possible causes

- The power supply voltage is too high
- The module is damaged. The module is damaged

2.27.5 Procedure

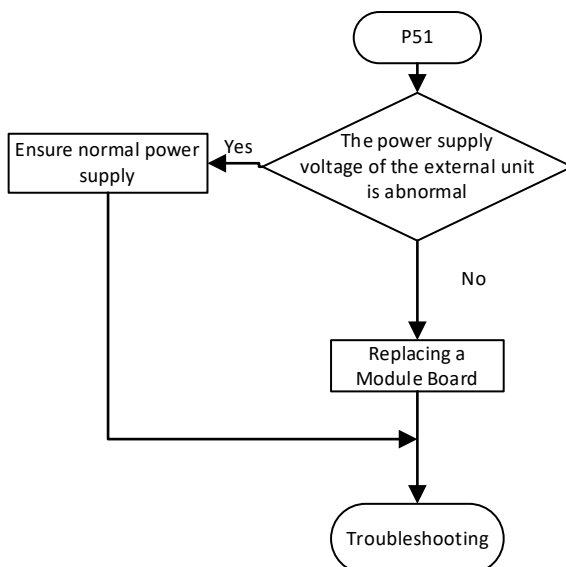

2.28 P52: Low voltage protection

2.28.1 Digital display output

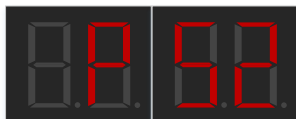

2.28.2 Description

- The AC voltage of the system is too low, triggering the protection shutdown
- All units stop running.
- Error code is displayed on the unit with the error

2.28.3 Trigger / recover condition

- Trigger condition: The Vac of Outdoor Unit less than 170 V
- Recover condition: Wait 7/15/30min for each occurrence, and the Vac of Outdoor Unit rises above 180 V
- Reset method: Resume automatically.

2.28.4 Possible causes

- The power supply voltage of the outdoor unit is abnormal or phase is missing
- Cables in the electric control box are loose
- Error in the high voltage circuit
- Inverter driver board is damaged

2.28.5 Procedure

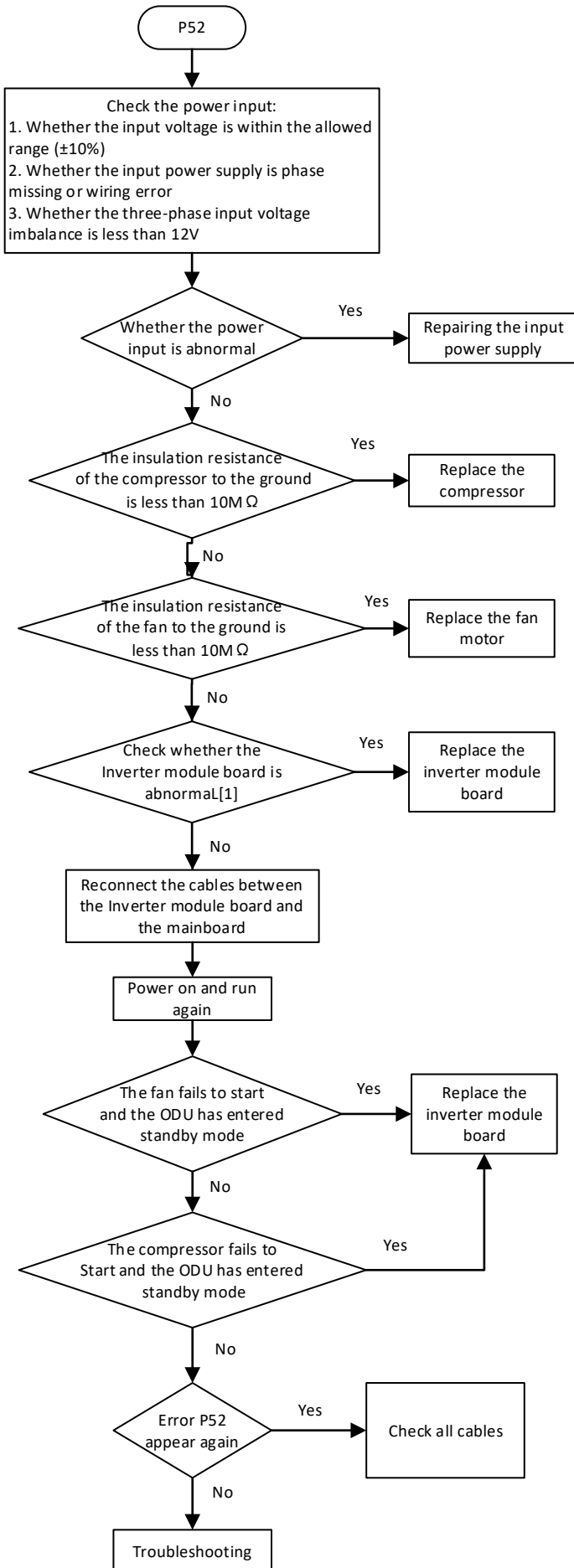

Note:

1. Refer to the Appendix "Inverter Module Board Detection".

2.29 P53: Phase B and N of the power cable are connected to the opposite protection

2.29.1 Digital display output



2.29.2 Description

- System zero line, phase line reverse connection
- All units stop running
- Error code is displayed on the unit with the error

2.29.3 Trigger / recover condition

- Trigger condition: Phase B is connected to the zero line in reverse
- Recover condition: Three-phase power phase sequence detection is correct
- Reset method: Resume automatically

2.29.4 Possible causes

- Outdoor Unit power supply B N is inversely connected
- Cables in the electric control box are loose
- inverter driver board is damaged
- A phase or two of the system power supply has a large load, resulting in power supply voltage imbalance:
- The distribution phase imbalance of the grid exceeds 3% (phase Angle imbalance, or three-phase voltage imbalance, or both):

2.29.5 Procedure

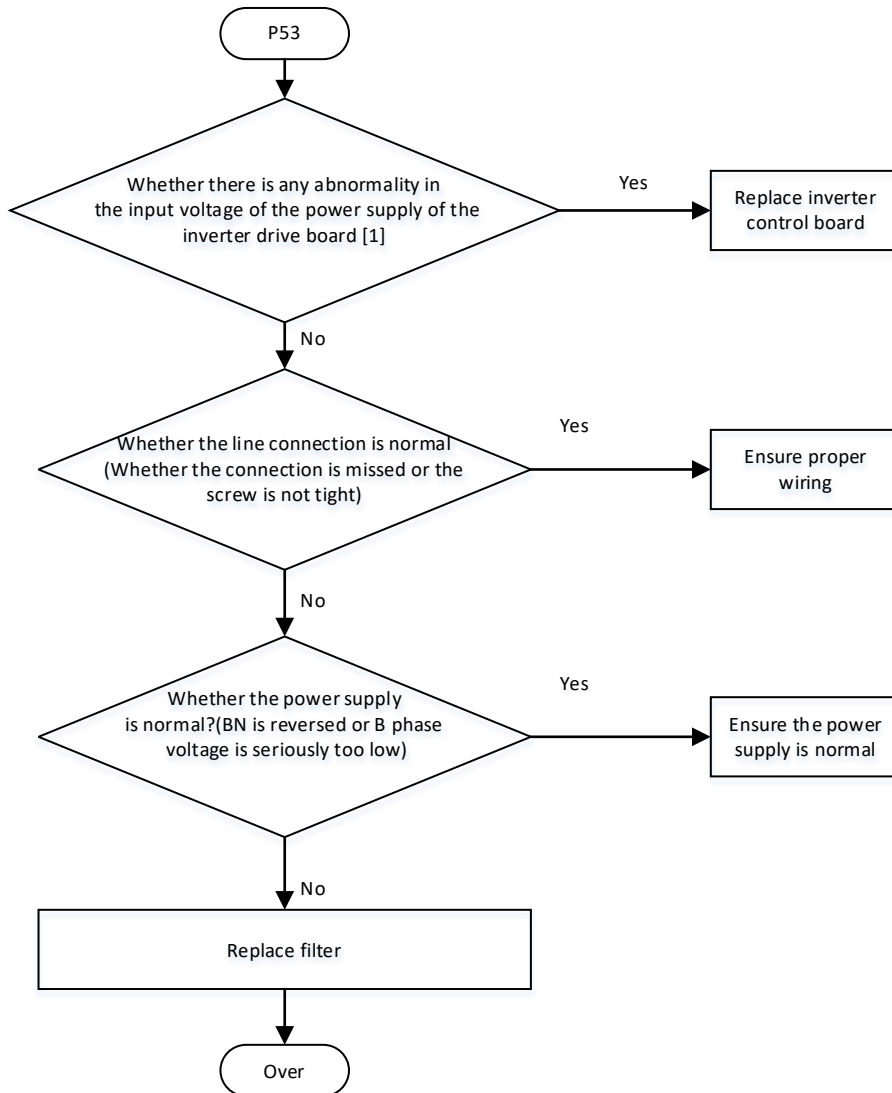

Notes:

1. When the system is powered on, use a multimeter to measure the voltages of the power input terminals L1,2, and L3 of the inverter drive board. Compare the voltages of L1-L2, L2-L3, and L1-L3. If basically equal, the power supply voltage is fine; if there is a difference of more than 10V, consider the power phase imbalance; if there is a difference of tens or even hundreds of volts, consider the power supply or the filter board has a problem.

2.30 P54: DC bus low voltage protection

2.30.1 Digital display output

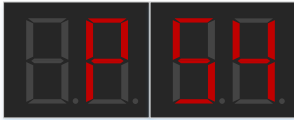

2.30.2 Description

- The DC bus voltage of the compressor is too low
- All units stop running.
- Error code is displayed on the unit with the error

2.30.3 Trigger / recover condition

- Trigger condition: The DC bus voltage of the Outdoor Unit is lower than the threshold.
- Recover condition: The DC bus voltage of the external unit is recovered above the threshold.
- Reset method: Resume automatically

2.30.4 Possible causes

- The input voltage is too low
- The power supply loose phase
- The model power supply information is incorrectly configured
- Inverter driver board is damaged

2.30.5 Procedure

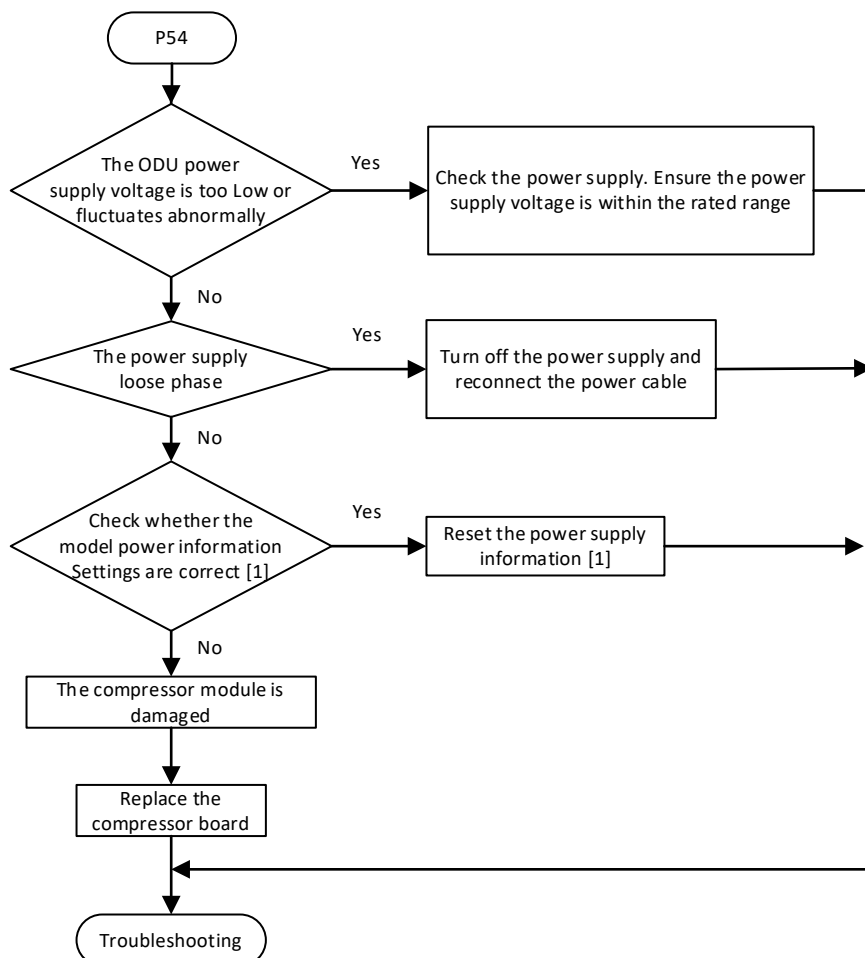

Note:[1] according to the power supply parameters

2.31 P55: Dc bus ripple over protection

2.31.1 Digital display output



2.31.2 Description

- The ripple of the dc bus on the module is over the limits.
- All units stop running.
- Error code is displayed on the unit with the error

2.31.3 Trigger / recover condition

- Trigger condition: Power input is out of phase or the three-phase power supply is seriously unbalanced
- Recover condition: Three-phase power supply without phase loss
- Reset method: Resume automatically when fault exit condition reached

2.31.4 Possible causes

- The Outdoor Unit power supply is out of phase or seriously unbalanced
- Cables in the electric control box are loose
- Inverter driver board is damaged
- Power supply is abnormal.

2.31.5 Procedure

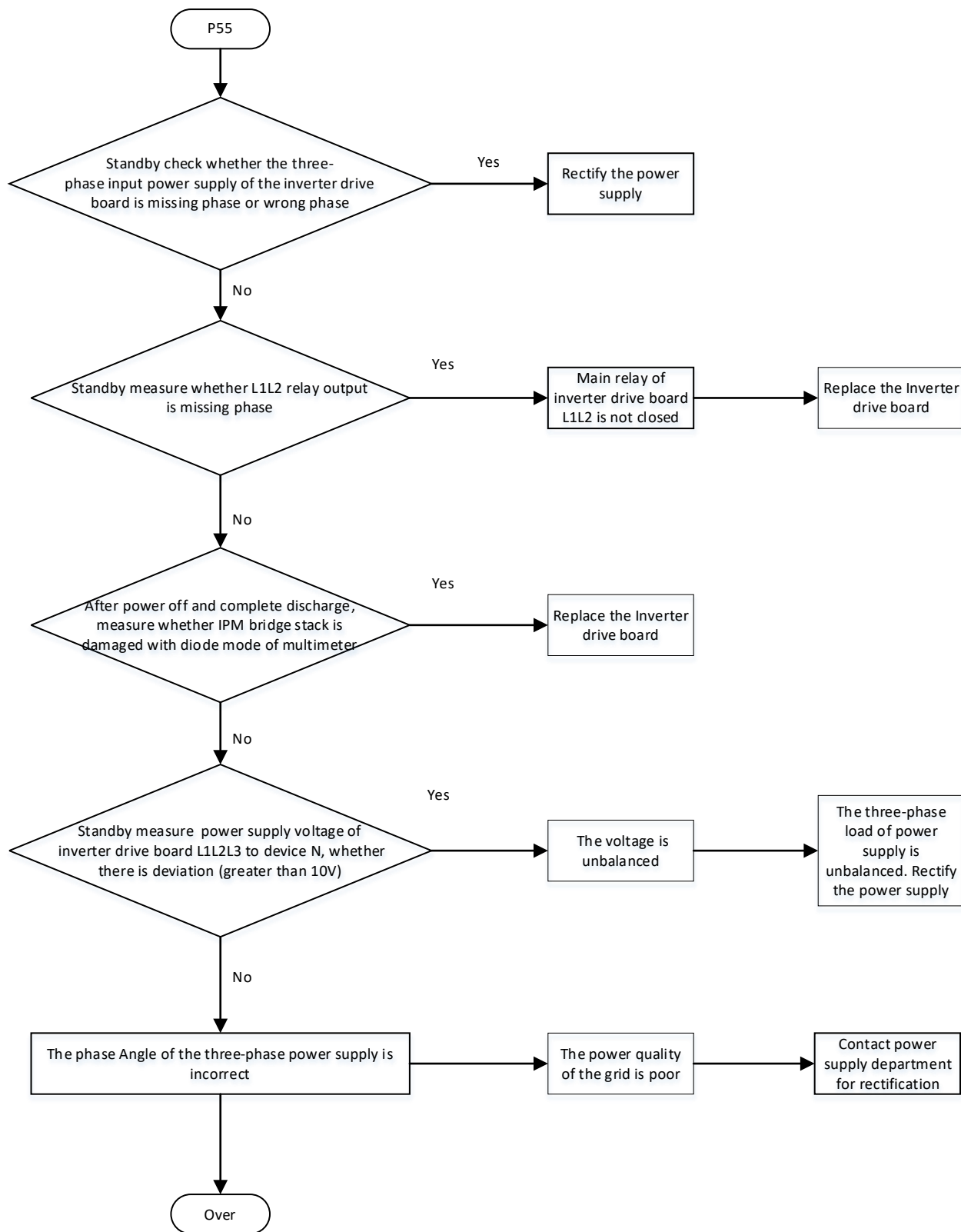

2.32 xP56: No.x inverter driver board DC bus voltage is too low

2.32.1 Digital display output



2.32.2 Description

- No.x inverter driver board DC bus voltage is too low
- All units stop running..
- Error code is displayed on the unit with the error

2.32.3 Trigger / recover condition

- Trigger condition: The inverter driver board upload L3E/J3E fails
- Recover condition: The inverter driver board does not upload L3E/J3E fails
- Reset method: Resume automatically.

2.32.4 Possible causes

- The Outdoor Unit power supply is too low or phase is missing
- Cables in the electric control box are loose
- Inverter driver board is damaged

2.32.5 Procedure

Troubleshoot according to J3E/L3E

2.33 xP57: No.x inverter driver board DC bus voltage is too high

2.33.1 Digital display output

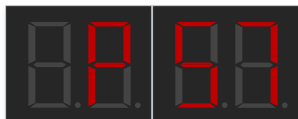

2.33.2 Description

- No.x inverter driver board DC bus voltage is too high
- All units stop running..
- Error code is displayed on the unit with the error

2.33.3 Trigger / recover condition

- Trigger condition: The inverter driver board upload L31/J31 fails
- Recover condition: The inverter driver board does not upload L31/J31 fails
- Reset method: Resume automatically.

2.33.4 Possible causes

- The Outdoor Unit power supply is too high
- Inverter driver board is damaged

2.33.5 Procedure

Troubleshoot according to J31/L31

2.34 xP58: No.x inverter driver board DC bus voltage is seriously too high

2.34.1 Digital display output

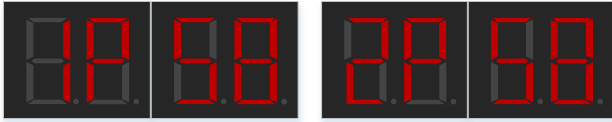

2.34.2 Description

- No.x inverter driver board DC bus voltage is seriously too high
- All units stop running..
- The error is displayed separately on each Outdoor Unit.

2.34.3 Trigger / recover condition

- Trigger condition: The inverter driver board upload L32/J32 fails
- Recover condition: The inverter driver board does not upload L32/J32 fails
- Reset method: Resume automatically.

2.34.4 Possible causes

- The input voltage is too high, resulting in the high DC bus voltage
- The power grid voltage is too high
- Inverter driver board is damaged

2.34.5 Procedure

Troubleshoot according to J32/L32

2.35 P71: Error in EEPROM

2.35.1 Digital display output



2.35.2 Description

- The EEPROM parameter of the ODU main control board is incorrect
- All units stop running.
- Error code is displayed on the unit with the error

2.35.3 Trigger / recover condition

- Trigger condition:EEPROM parameter verification is incorrect
- Recover condition:EEPROM parameter verification is correct
- Reset method:Resume manually

2.35.4 Possible causes

- EEPROM units damaged:
- Main control board is damaged:

2.35.5 Procedure

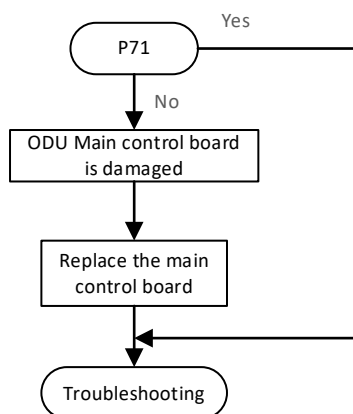

2.36 Pb1: HyperLink overcurrent error

2.36.1 Digital display output

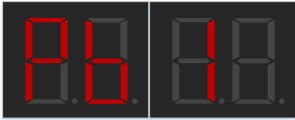

2.36.2 Description

- HyperLink overcurrent error
- All units stop running.
- Error code is displayed on master ODU.

2.36.3 Trigger / recover condition

- Trigger condition:
No IDU is in power down mode and the feedback voltage of the HyperLink board is $> 1.5V$ for 120ms.
- Recover condition: HyperLink board feedback voltage $< 0.2V$
- Reset method: fault time < 2 hours, automatic recovery; If the fault time > 2 hours, power on again

2.36.4 Possible causes

- The M1M2 communication line of the master ODU is short-circuited.
- The M1M2 communication line of the master ODU is connected to other communication line (not M1M2) of the IDU.
- The M1M2 communication line of the master ODU is connected to port "TO DOWN IDU" of the repeater.
- Main control board is damaged

2.36.5 Procedure

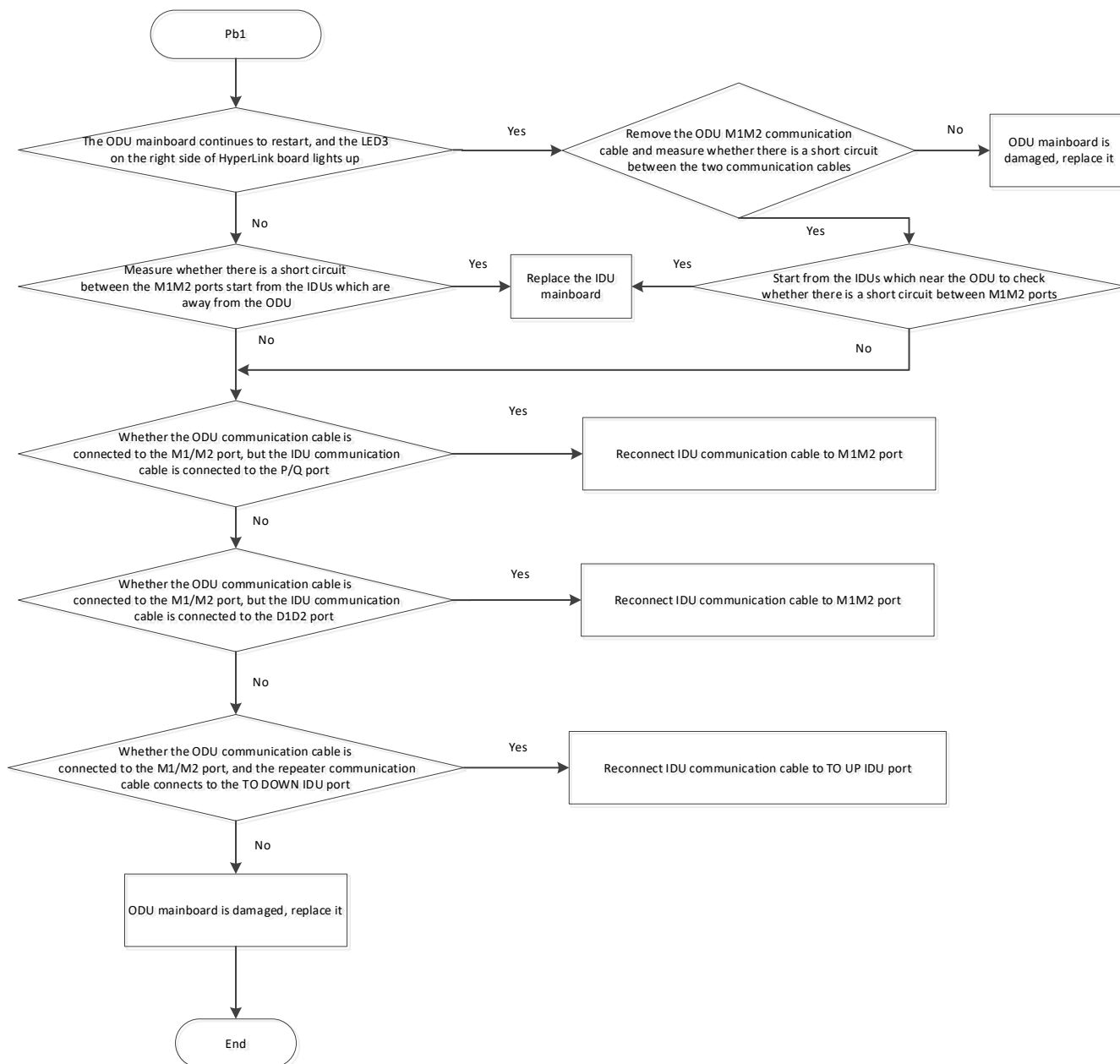

2.37 Pd1, Pd2: Anti-condensation protection

2.37.1 Digital display output



2.37.2 Description

- Anti-condensation protection
- All units stop running.
- Error code is displayed on the unit with the error

2.37.3 Trigger / recover condition

- Trigger condition:
 - Pd1: The outlet temperature of Microchannel heat exchanger is below the dew point temperature for more than 10 minutes
 - Pd2: Pd1 protection occurs 2 times in 60 minutes
- Recover condition: The outlet temperature of Microchannel heat exchanger is higher than the dew point temperature
- Reset method: Power on again.

2.37.4 Possible causes

- Temperature sensors T6A, T6B, and T5 are not installed in the correct positions
- Temperature sensor T6A, T6B, and T5 are damaged
- Electronic expansion valve EXVC cannot be fully closed
- The internal electronic expansion valve is too open or cannot be adjusted.
- Main control board is damaged

2.37.5 Procedure

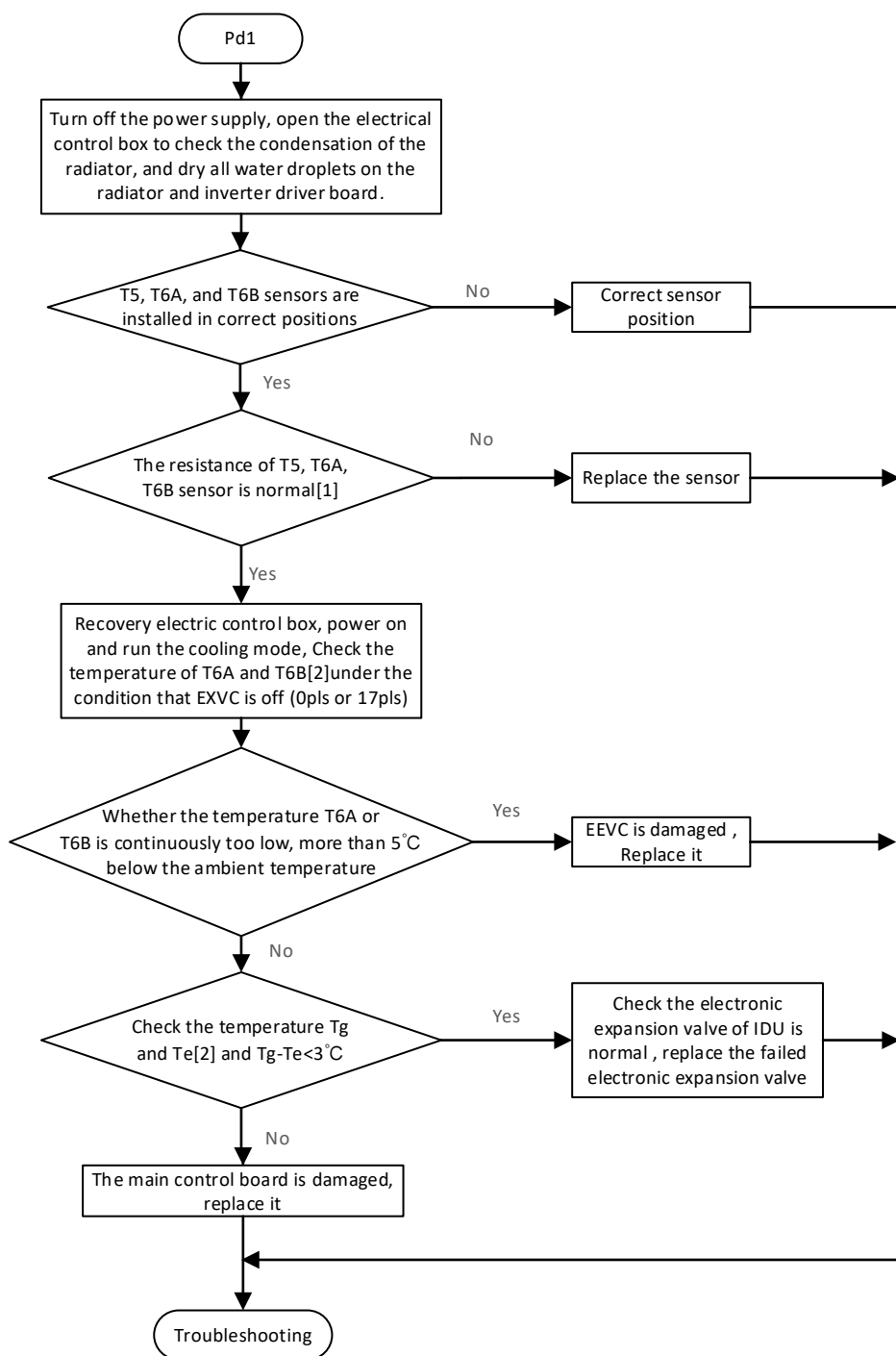

Note:

[1] Refer to the *Table 5.1.1: Temperature sensor temperature resistance characteristic table*

[2] Refer to the **Part 4-4.4 Digital display and button settings**

2.38 xb01: The electronic expansion valve is in error

2.38.1 Digital display output



2.38.2 Description

- No.x electronic expansion valve's connection on main control board is missing(1 to 4 correspond to expansion valves A, B, C, and E respectively)
- All units stop running Electronic
- Error code is displayed on the outdoor unit with error.

2.38.3 Trigger / recover condition

- Trigger condition: After the system is powered on, the outdoor unit cannot detect the signal of electronic expansion valve within 2 minutes.
- Recover condition: After the system is powered on again, the outdoor unit can detect the signal of electronic expansion valve.
- Reset method: Resume manually, and power on again.

2.38.4 Possible causes

- Electronic expansion valve is not connected to main control board correctly.
- The electronic expansion valve coil is damaged
- The main control board is damaged.

2.38.5 Procedure

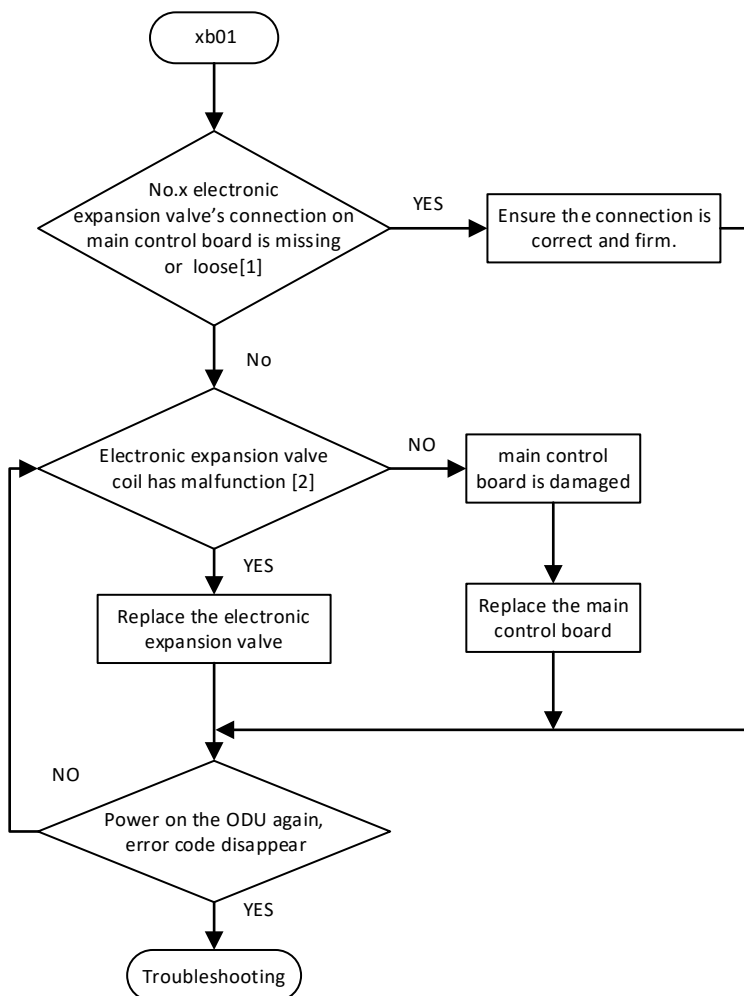

Notes:

[1] All models of ODU have electronic expansion valves A and C, which are connected to the main boards CN70 and CN72. Some models have electronic expansion valves B and E with CN71 and CN73 ports

[2] Schematic diagram of coil resistance measurement of electronic expansion valve and reference range of resistance

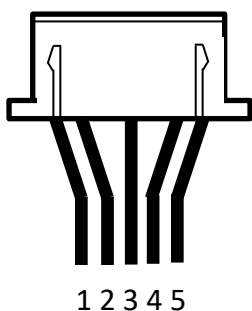

Side Flow Series			
Model capacity range	8-14HP	16-22HP	
The body coil	Valve A/C/E	Valve C/E	Valve A
Measurement point	resistance	resistance	resistance
1-5	40-50 Ω	40-50 Ω	90-110 Ω
2-5	40-50 Ω	40-50 Ω	90-110 Ω
3-5	40-50 Ω	40-50 Ω	90-110 Ω
4-5	40-50 Ω	40-50 Ω	90-110 Ω

2.39 U11: Outdoor unit model is not set

2.39.1 Digital display output



2.39.2 Description

- All units stop running
- Error code is displayed on the unit with the error

2.39.3 Trigger / recover condition

- Trigger condition: The model information is not set.
- Recover condition: The model information of the unit is set correctly
- Reset method: Resume manually

2.39.4 Possible causes

- The model information is not set

2.39.5 Procedure

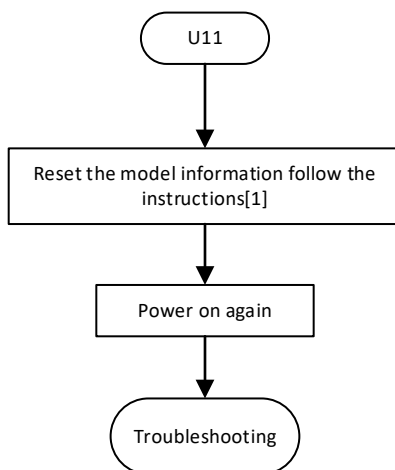

Note:

[1] Use the Bluetooth module or Bluetooth after-sales kit

2.40 U12: Outdoor unit Capacity setting error

2.40.1 Digital display output



2.40.2 Description

- The capability information of outdoor unit is not set
- All units stop running
- Error code is displayed on the unit with the Error

2.40.3 Trigger / recover condition

- Trigger condition: The capability information of outdoor unit is not set
- Recover condition: Reset the capability information of outdoor unit
- Reset method: Resume manually

2.40.4 Possible causes

- The capability information of outdoor unit is not set

2.40.5 Procedure

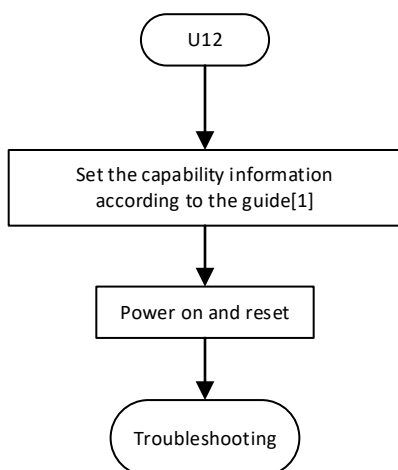

Note:

[1] Set the capability information according to the nameplate

2.41 U21: The indoor unit connection is incorrect

2.41.1 Digital display output



2.41.2 Description

- The indoor unit connection is incorrect
- All Outdoor units stop running
- Error is only displayed in main control board

2.41.3 Trigger / recover condition

- Trigger condition:

The following devices can be connected to the VRF system:

- Standard air-cooled indoor units
- AHU KIT
- Hydraulic module

The following join combinations are allowed:

- VRF Indoor Unit + AHU KIT
- VRF Indoor Unit + Hydraulic module
- VRF Indoor Unit

Apart from the above three combination modes, the system detects the combination of indoor units and reports the following failure prompt

Error code	The system checks the connected Indoor Unit type
U21	The system is connected to the old Indoor Unit

- Recover condition:
Correct Indoor Unit assembly is detected
- Reset method: Resume manually

2.41.4 Possible causes

- the Indoor Unit assembly does not meet the requirement

2.41.5 Procedure

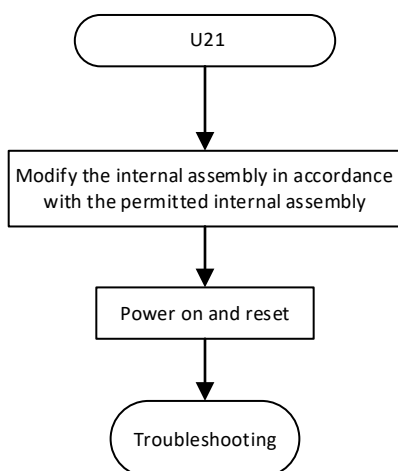

2.42 U31: The test run was never successful

2.42.1 Digital display output



2.42.2 Description

- The test run was unsuccessful
- All units stop running
- Error code is only displayed on the master unit.

2.42.3 Trigger / Recover condition

- Trigger condition: The test run was unsuccessful
- Recover condition: The test run complete Successfully.
- Reset method: Resume manually

2.42.4 Possible causes

- The test run was unsuccessful

2.42.5 Procedure

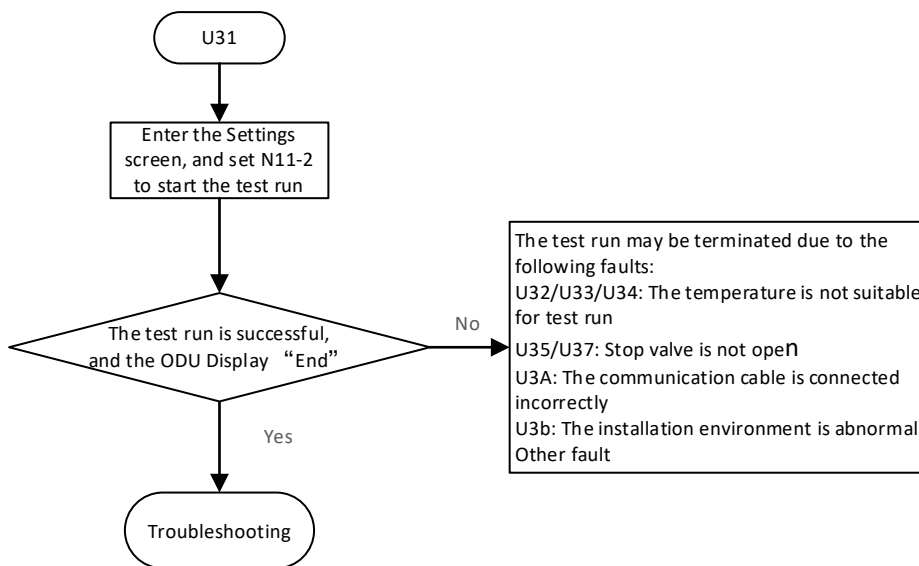

2.43 U32, U33, U34: The temperature is not suitable for test run

2.43.1 Digital display output



2.43.2 Description

- Ambient temperature is out the allowed range of test run
- All units stop running
- Error code is only displayed on Outdoor Unit

2.43.3 Trigger /Recover condition

- Trigger condition:

After entering into test run, the master unit estimates whether it is suitable for test run according to the indoor average return air temperature T1 and outdoor average ambient temperature T4(Refer to the following figure and table). If it is not suitable for test run, the outdoor unit displays an error code like “U32, U33, U34”

Figure 2-4.1: ambient temperature range of test run

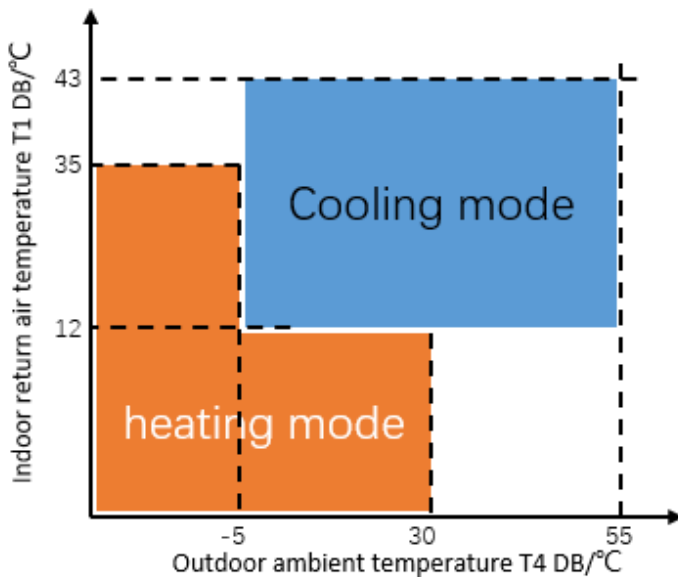

Error code	Description	
U32	The outdoor temperature is not suitable	Average T1<-12°C :T4min>30°C or T4min<-30°C Average T1≥12 °C : T4min>55 °C or T4min<-30 °C
U33	The indoor temperature is not suitable	T4min≤-5 °C: Average T1>35 °C T4min≥-5 °C: Average T1>43 °C
U34	The indoor and outdoor temperature is not suitable	Average T1>43 °C and T4min>55 °C

- Recover condition: Press the "OK" button on the main control board for 5 seconds to exit the rest run.
- Reset method: Resume manually

2.43.4 Possible causes

- The Temperature out of test run range

2.43.5 Procedure

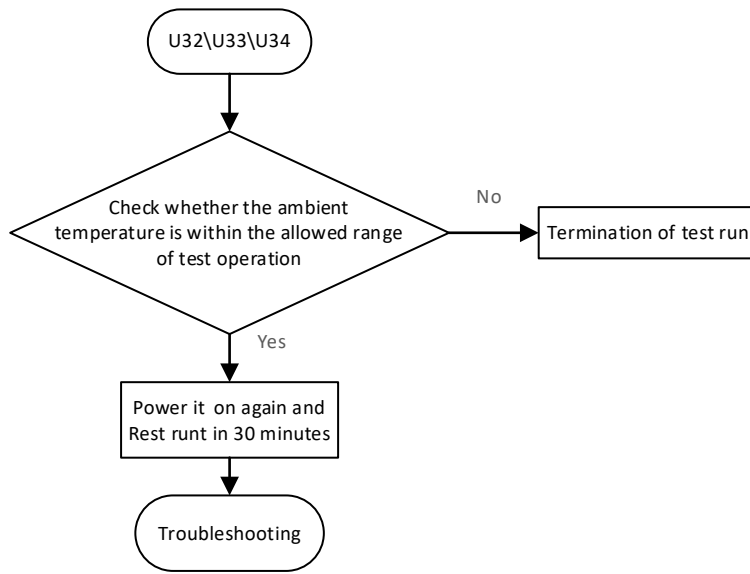

2.44 U35, U37: Stop valve is not open

2.44.1 Digital display output



2.44.2 Description

- Stop valve is not open
- All units stop running
- Error code is only displayed on the master unit.

2.44.3 Trigger/ Recover condition

- Trigger condition:

Error code	Description	
U35	The liquid side stop valve of the system is not opened	discharge pressure of heating mode \geq 3.9MPa
U37	The gas side stop valve of the system is not opened	suction pressure of cooling mode $<$ 0.12MPa

- Recover condition:
Press the "OK" button on the main control board for 5 seconds to exit the test run.
- Reset method: Resume manually

2.44.4 Possible causes

- Stop valve is not open

2.44.5 Procedure

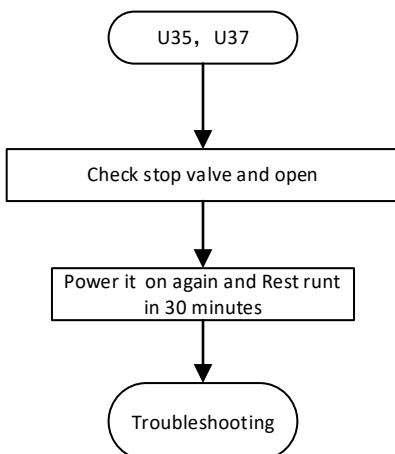

2.45 U3A: The communication cable is connected incorrectly

2.45.1 Digital display output



2.45.2 Description

- There are indoor unit in the communication system outside the refrigerant system.
- All units stop running
- Error code only displayed on the master unit.

2.45.3 Trigger / Recover condition

- Trigger condition: There are indoor unit in the communication system outside the refrigerant system.
- Recover condition: Press the "OK" button on the main board for 5 seconds to exit the rest run.
- Reset method: Resume manually

2.45.4 Possible causes

- There are IDU in other refrigerant system connect with ODU by commication cable

2.45.5 Procedure

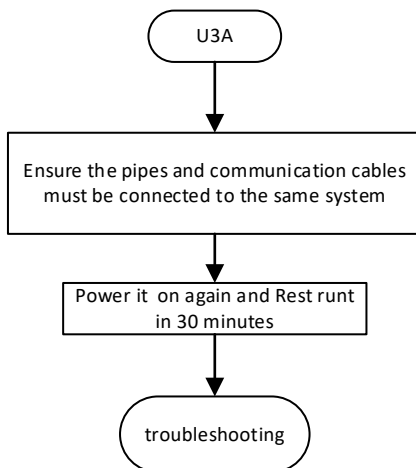

2.46 U3b: The installation environment is abnormal

2.46.1 Digital display output



2.46.2 Description

- During the test run, abnormal changes in ambient temperature are detected and the operation is stopped.
- All units stop running
- Error code only displayed on the master unit.

2.46.3 Trigger / Recover condition

- Trigger condition:
 - ① Cooling mode: the return air temperature is detected to increase more than 10°C during test run.
 - ② Heating mode: the return air temperature is detected to decrease more than 10°C during test run.
- Recover condition: Press the "OK" button on the main board for 5 seconds to exit the rest run.
- Reset method: Resume manually

2.46.4 Possible causes

- The installation environment of the IDU has poor ventilation and heat dissipation, and the outlet air and return air form short circuit
- Return air of the IDU is affected by other heat sources
- The return air temperature sensor of the IDU is improperly installed or damaged

2.46.5 Procedure

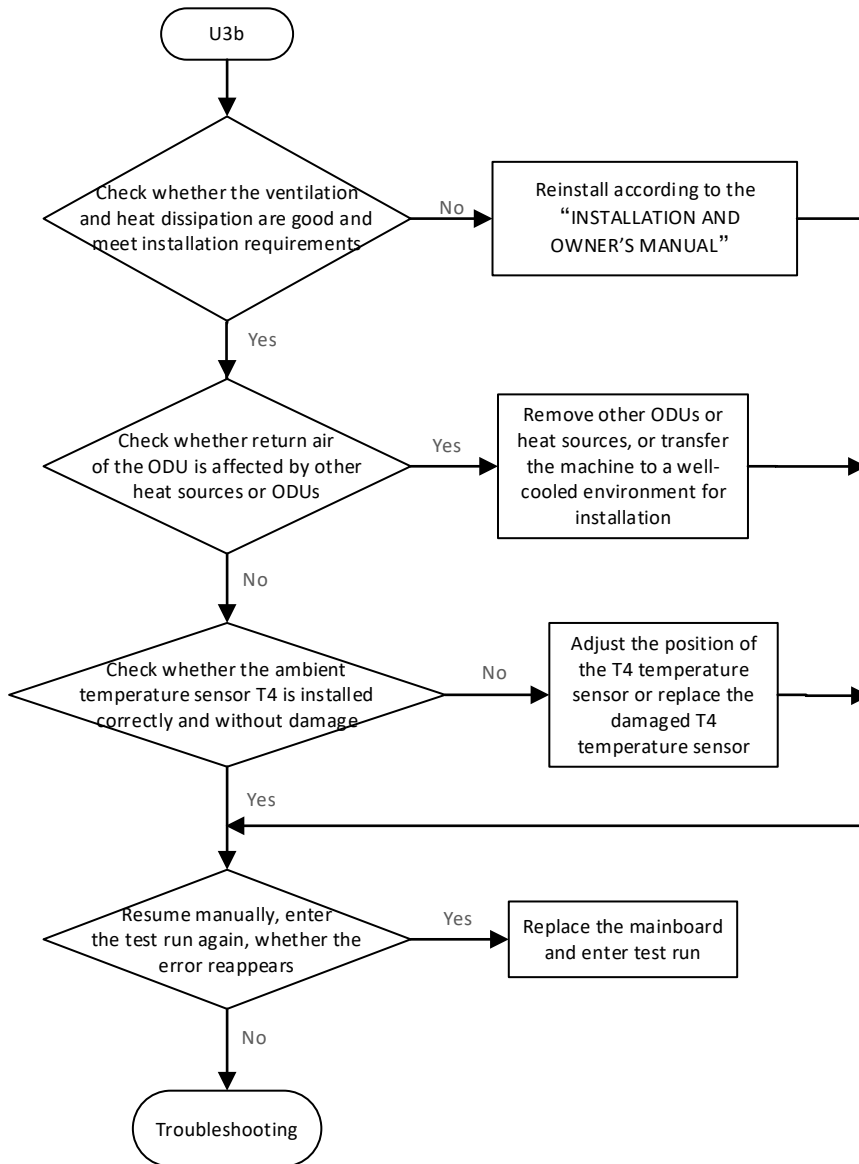

2.47 U3C: Changeover mode error

2.47.1 Digital display output



2.47.2 Description

- The ODU in changeover mode doesn't detect the signal of VIP IDU.
- ODUs stop running
- Error code only displayed on the master unit.

2.47.3 Trigger / Recover condition

- Trigger condition:
 - ①The ODU in changeover mode , but the VIP address has not been set.
 - ②The ODU in changeover mode doesn't detect the signal of VIP IDU(the VIP address has been set).
- Recover condition: The ODU in changeover mode detect the signal of VIP IDU.
- Reset method: Resume automatically

2.47.4 Possible causes

- The VIP address has not been set
- The communication between the VIP IDU and ODU is abnormal
- The mainboard of ODU is damaged.

2.47.5 Procedure

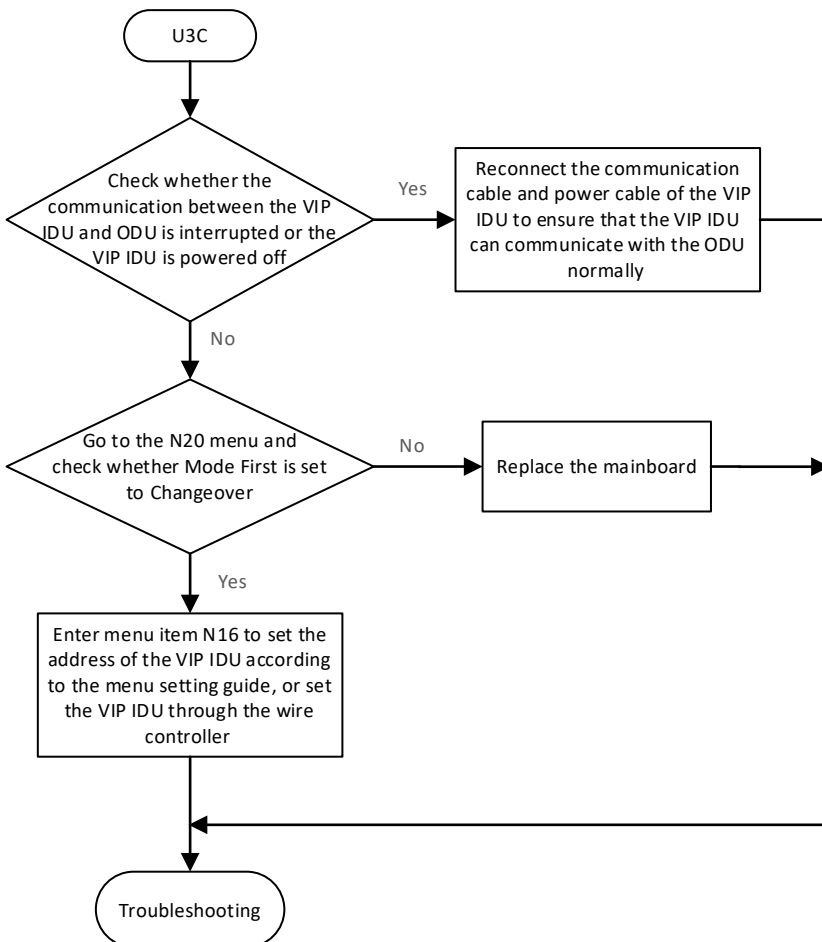

2.48 U4x: Overconnection ratio

2.48.1 Digital display output



2.48.2 Description

- Protection Overconnection ratio
- All units stop running

2.48.3 Trigger / Recover condition

- Trigger condition:

1) Code of Indoor Unit and type analysis

Code of Indoor Unit	Indoor Unit A	Indoor Unit B	Indoor Unit C	Indoor Unit D
Type of Indoor Unit	VRF Air-cooled indoor unit	Fresh Air Processing Unit	AHU KIT(Air outlet temperature control)	AHU KIT(Return air temperature control)

Error code	Description
U41	connection ratio A <45% or connection ratio A >135%
	connection ratio A+D <45% or connection ratio A+D >135%
U42	connection ratio B <45% or connection ratio B >105%
	connection ratio B+C >35%
U43	connection ratio C <45% or connection ratio C >105%
U44	connection ratio D <45% or connection ratio D >115%
U48	connection ratio A+B+C+D >135%

2) computing method of connection ratio:

Connection ratio A=total capacity of Online Indoor UnitA /total capacity of Outdoor Unit

Connection ratio B=total capacity of Online Indoor UnitB /total capacity of Outdoor Unit

Connection ratio C=total capacity of Online Indoor UnitC /total capacity of Outdoor Unit

Connection ratio D=total capacity of Online Indoor UnitD /total capacity of Outdoor Unit

Connection ratio A+D=total capacity of Online Indoor UnitA+ UnitD/total capacity of Outdoor Unit

Connection ratio B+C=total capacity of Online Indoor UnitB+ UnitC/total capacity of Outdoor Unit

Connection ratio A+B+C+D= total capacity of Online Indoor UnitA+ UnitB+ UnitC+ UnitD/total capacity of Outdoor Unit

- Recover condition:

Indoor/Outdoor Unit connection rate within allowable range

- Reset method: Resume manually

2.48.4 Possible causes

Indoor/Outdoor Unit connection rate out of allowable range

2.48.5 Procedure

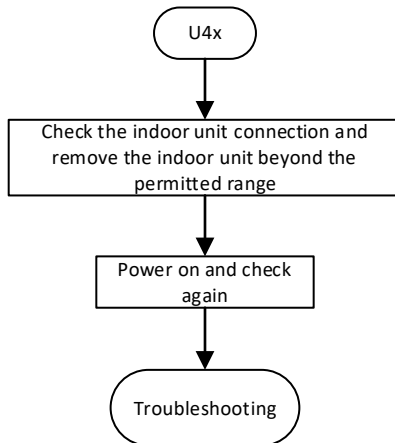

2.49 U51: Outdoor unit of Individual Series is installed in combine system

2.49.1 Digital display output



2.49.2 Description

- Outdoor unit of Individual Series is installed in combine system
- All units stop running
- Error code is only displayed on master unit.

2.49.3 Trigger / Recover condition

- Trigger condition:
Outdoor unit of Individual Series is installed in combine system
- Recover condition:
Remove the Individual Series from combined system
- Reset method: Resume manually

2.49.4 Possible causes

- Outdoor unit of Individual Series is installed in combine system
- Outdoor unit model is incorrectly set

2.49.5 Procedure

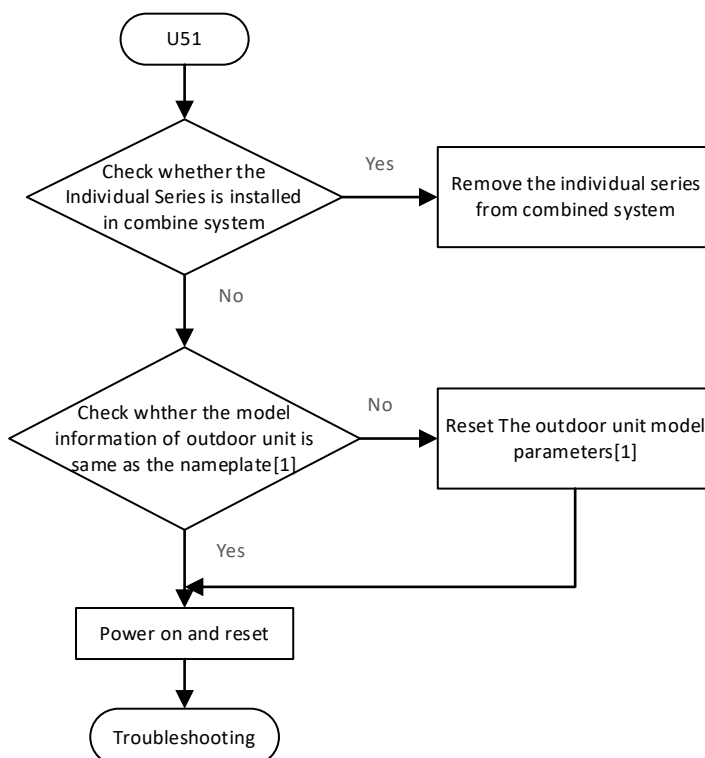

Note:

[1]Use Bluetooth module or bluetooth after-sales kit to check and reset the model parameter.

2.50 U53: Detected different series outdoor units in the same VRF system

2.50.1 Digital display output

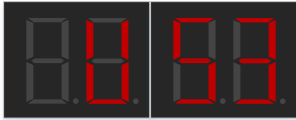

2.50.2 Description

- Detected different series outdoor units in the same VRF system
- All units stop running
- Error code is only displayed master unit

2.50.3 Trigger / Recover condition

- Trigger condition:
Detected different series outdoor units in the same VRF system
- Recover condition:
There is only one series of Outdoor Unit in combined system
- Reset method: Resume manually

2.50.4 Possible causes

- Detected different series outdoor units in the same VRF system

2.50.5 Procedure

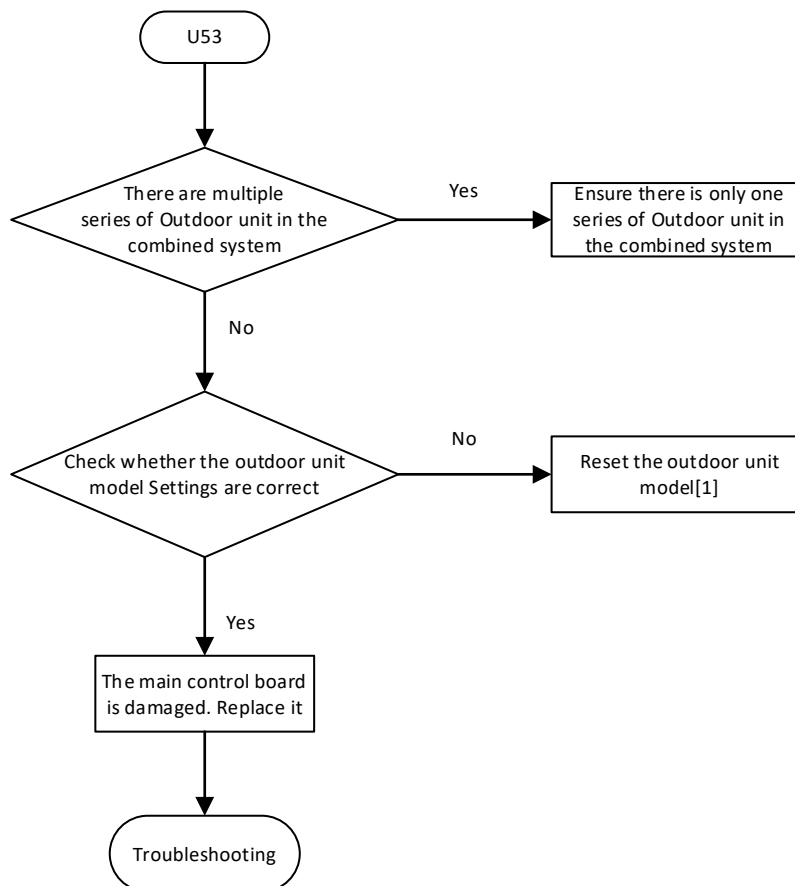

Note:

[1]Use Bluetooth module or bluetooth after-sales kit to check and reset the model parameter.

3 Error in Compressor Driver

3.1 xL1E: Hardware overcurrent

3.1.1 Digital display output



3.1.2 Description

- The current exceeds the OCP protection value (peak value) set by the hardware or the IPM module receives an FO signal
- The compressor stops running after the error occurs. If the error disappears one minute later, the compressor starts again

3.1.3 Trigger / recover condition

(1)Current reaches OCP protection value:

- Trigger condition:Current reaches OCP protection value
- Recover condition:The compressor will stop after failure, and recover after one minute when the condition of failure exit is reached
- Reset method:The system automatically recovers one minute after the error exit condition is reached

(2)Falling edge of FO signal or continuous low level is detected:

- Trigger condition: A falling edge or continuous low level of FO signal is detected.
- Recover condition: The FO signal becomes high level.
- Reset method: Resume automatically one minute after the error exit condition is reached.

3.1.4 Possible causes

- There are impurities in the refrigerant system or the compressor suddenly freezes the cylinder, resulting in abnormal current increase and triggering OCP:
- Compressor windings short-circuit between phases, resulting in instantaneous large current triggering OCP or FO:
- The OCP is triggered when the system power supply voltage falls or is interrupted for a short time:
- The IPM module condenses, causing a short circuit between control pins:
- Liquid refrigerant back to the compressor:
- Before starts the compressor has a certain speed:
- Module board is abnormal. (Idc operational amplifier circuit, OCP comparison circuit, PWM circuit, IPM, IGBT drive power circuit) Causes control out-of-step to generate high current to trigger OCP.

3.1.5 Procedure

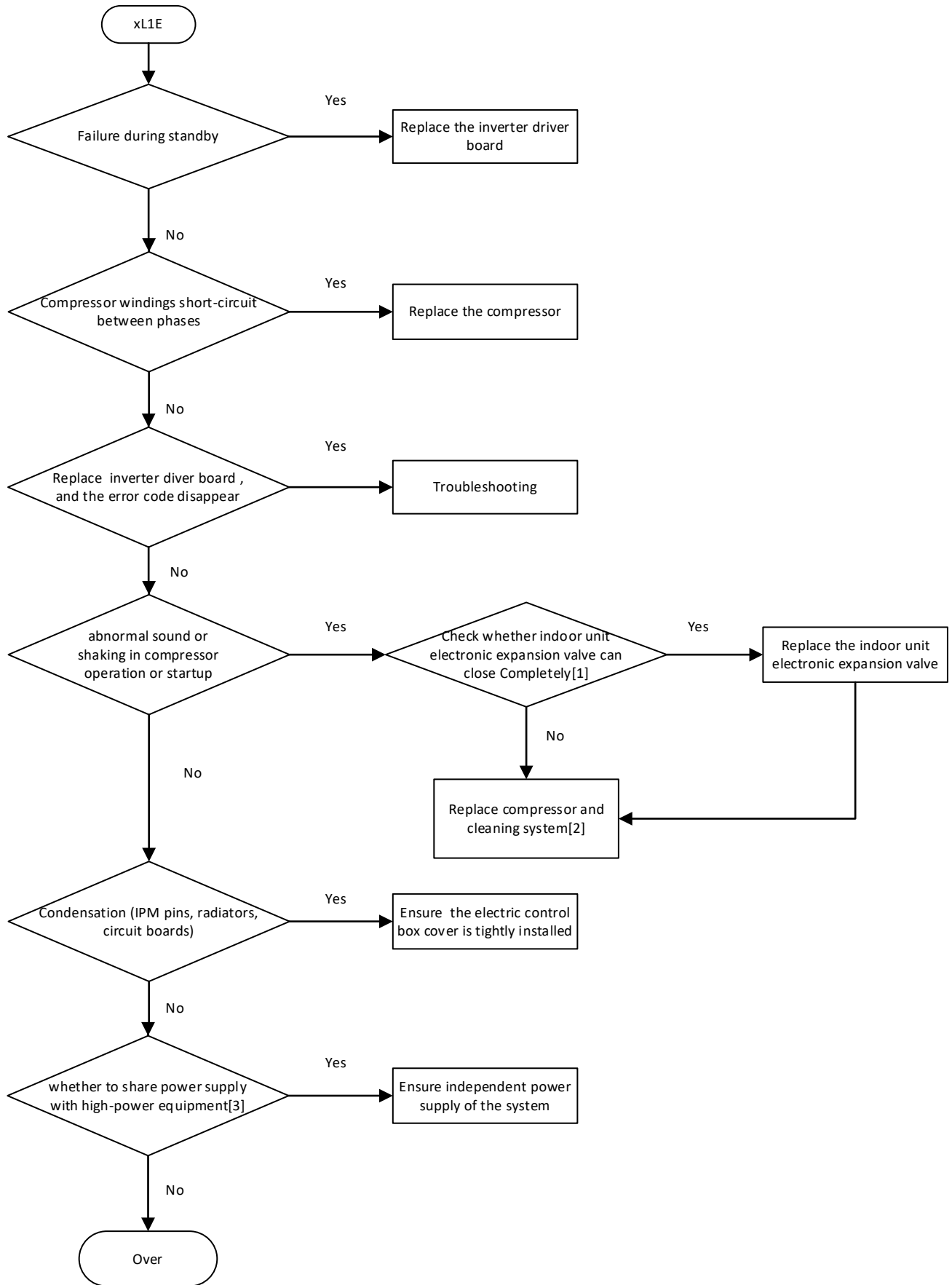

Notes:

[1] Close the IDU and check whether the temperature of the Gas pipe is too low or frosted or the evaporator is frosted.

[2] Maybe there are impurities in the refrigerant system

[3] Voltage fluctuation occurs when high-power equipment is started

3.2 xL11, xL12 : Software overcurrent

3.2.1 Digital display output



3.2.2 Description

- The current exceeds the OCP protection value set by the software.
- The compressor will shutdown when the error occurs. If the error disappears one minute later, the compressor will start again.

3.2.3 Trigger / recover condition

- Trigger condition:
 - xL11: The compressor current exceeds the OCP protection value set by the software in three consecutive carrier periods
 - xL12: Software overcurrent protection last 30s
- Recover condition: The compressor will stop when the error occurs. If the error disappears one minute later, the compressor will start again
- Reset method: Resume automatically after reaching exit condition of Error

3.2.4 Possible causes

- There are impurities in the refrigerant system or the compressor suddenly jam the cylinder:
- The Idc op-amp sampling circuit on the module is abnormal:

3.2.5 Procedure

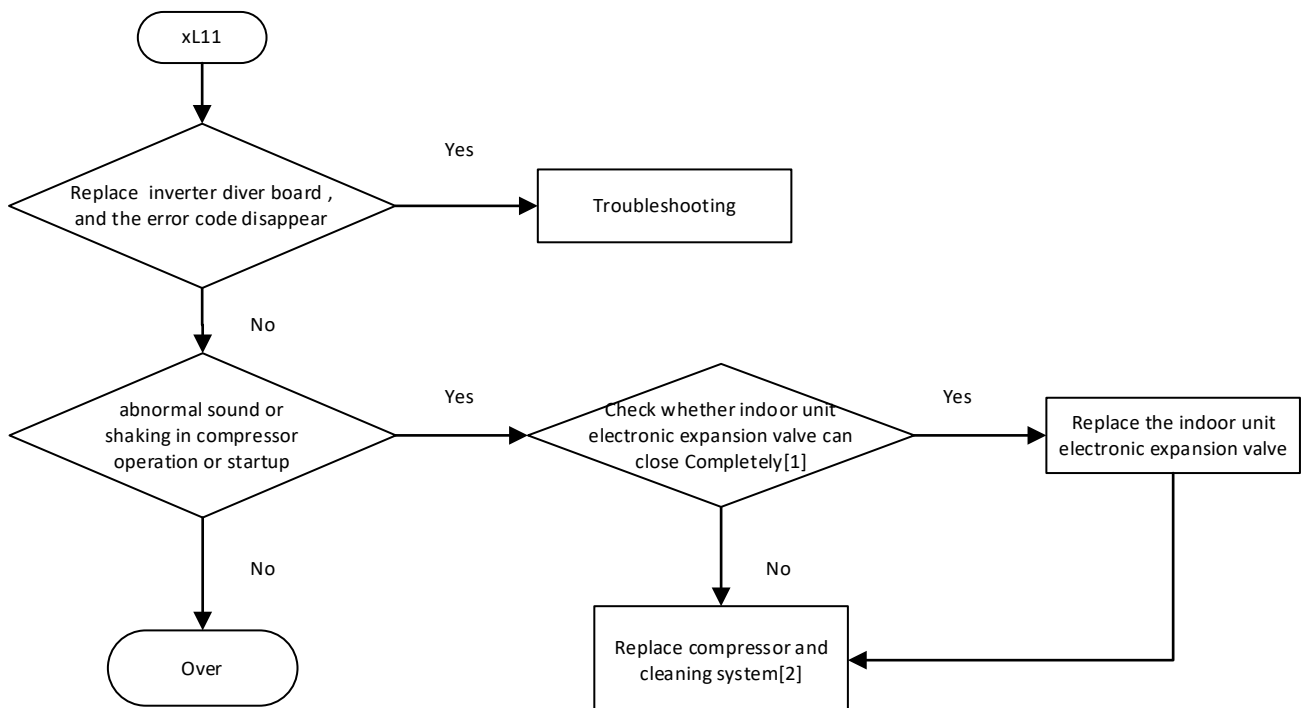

Notes:

- [1] Close the IDU and check whether the temperature of the Gas pipe is too low or frosted or the evaporator is frosted.
 [2] Maybe there are impurities in the refrigerant system

3.3 xL2E: Module overtemperature protection

3.3.1 Digital display output

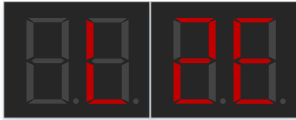

3.3.2 Description

- The temperature of the IPM exceeds 105° C.
- The compressor will stop when the error occurs. If the error disappears one minute later, the compressor will start again

3.3.3 Trigger / recover condition

- Trigger condition: The temperature of the IPM exceeds 105° C
- Recover condition: the module temperature is lower than 105°
- Reset method: Resume automatically

3.3.4 Possible causes

- The IPM screws are not tightened, resulting in poor heat dissipation:
- The heat dissipation silicone for the IPM module is not evenly applied, resulting in poor heat dissipation:
- The refrigerant radiator is poor due to lack of refrigerant or the refrigerant radiator pipe is blocked:
- The welding of the refrigerant radiator is abnormal, resulting in poor heat dissipation
- The IPM temperature detection circuit is abnormal

3.3.5 Procedure

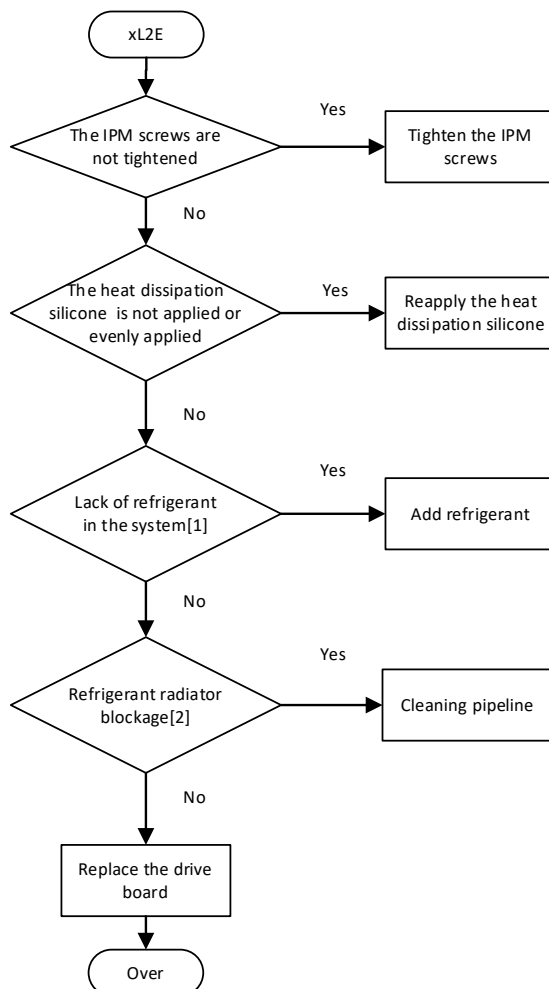

Notes:

[1] Less refrigerant system results in higher Discharge temperature of the compressor, lower Discharge and suction pressure, lower current, and frost on the gas return pipe. Refer to **Table 5.2.1 and 5.2.2** "Normal Refrigerant System parameters" in Chapter 5 for normal system parameters.

[2] Refer to radiator inlet and outlet temperature

3.4 xL3E: The bus voltage is too low

3.4.1 Digital display output



3.4.2 Description

- Bus voltage is lower than the low bus voltage protection threshold set by the software (350VDC).
- The compressor stops running after the error occurs. If the error disappears one minute later, the compressor starts again.

3.4.3 Trigger / recover condition

- Trigger condition: The bus voltage is lower than the bus voltage protection threshold set by the software.
- Recover condition: The bus voltage is higher than the low bus voltage protection threshold set by the software
- Reset method: Resume automatically after the error exit condition is reached.

3.4.4 Possible causes

- The input voltage is too low, resulting in the low bus voltage:
- Voltage sag or interruption, resulting in transient bus voltage is too low:
- The bus voltage detection circuit of the module is abnormal:

3.4.5 Procedure

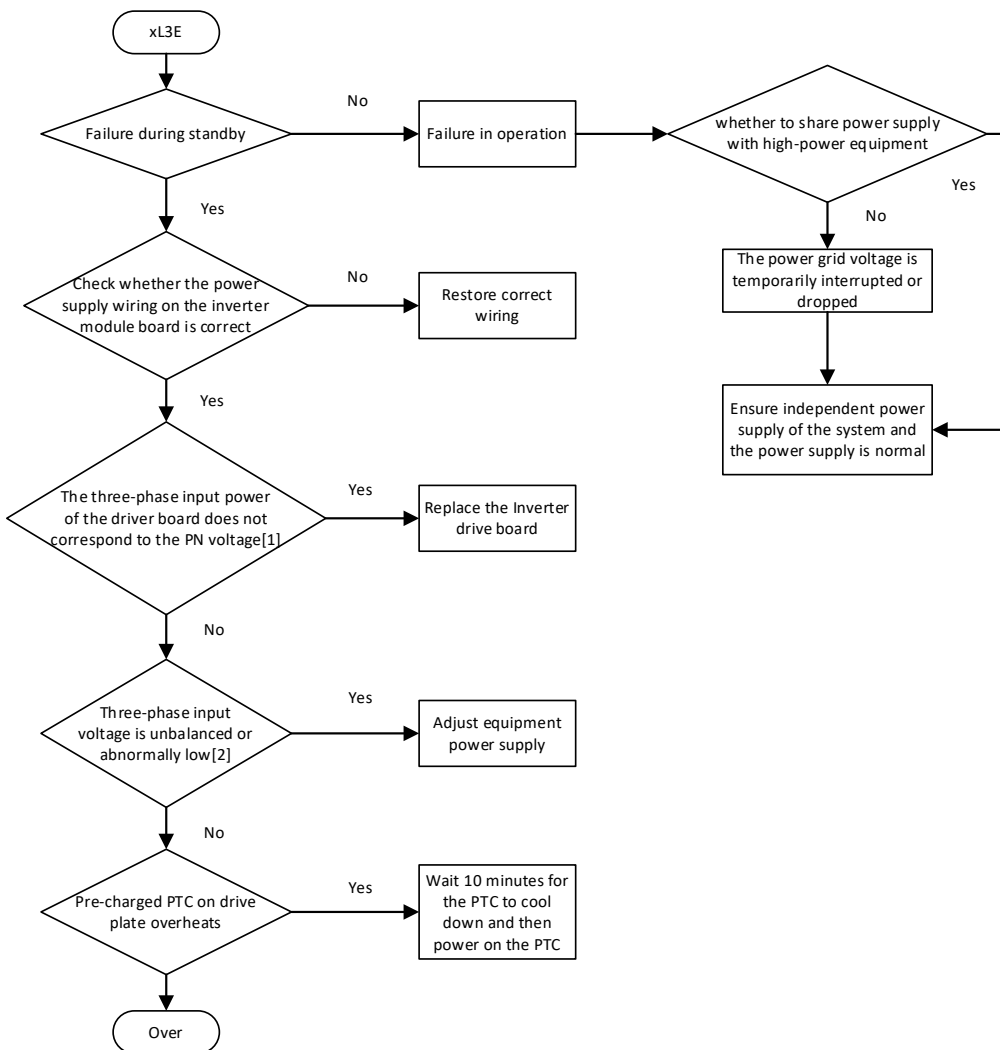

Notes:

[1] $V_{dc} = V_{AC} * 1.732$, such as the corresponding PN $V_{dc} = 540V_{DC}$ for the 380V input.

[2] Line voltage below 247VAC

3.5 xL31: The bus voltage is too high

3.5.1 Digital display output



3.5.2 Description

- Bus voltage is higher than the high bus voltage protection threshold set by the software (800VDC).
- The compressor stops running after the error occurs. If the error disappears one minute later, the compressor starts again.

3.5.3 Trigger / recover condition

- Trigger condition: The bus voltage is higher than the software overvoltage protection threshold.
- Recover condition: the bus voltage is lower than the overvoltage protection threshold set by the software.
- Reset method: Resume automatically after the error exit condition is reached.

3.5.4 Possible causes

- The input voltage is too high, resulting in the high bus voltage;
- The power grid voltage is too high;
- The bus voltage detection circuit of the module is abnormal:

3.5.5 Procedure

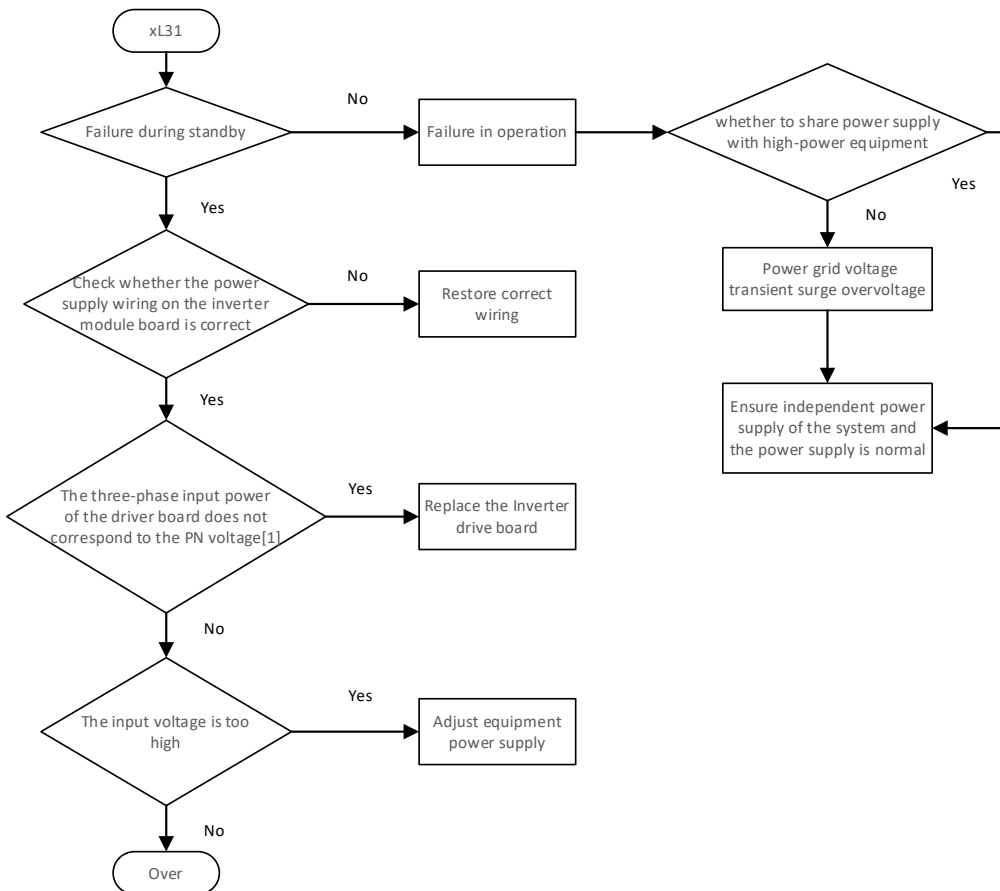

Notes:

[1] $V_{dc} = V_{AC} * 1.732$, such as the corresponding PN $V_{dc} = 540V_{DC}$ for the 380V input.

3.6 xL32: The bus voltage is excessively high

3.6.1 Digital display output



3.6.2 Description

- Bus voltage is higher than the high bus voltage protection threshold set by the software (820VDC).
- The compressor stops running after the error occurs. If the error disappears one minute later, the compressor starts again.

3.6.3 Trigger / recover condition

- Trigger condition: The bus voltage is too high, higher than the high bus voltage protection threshold set by the software (820VDC)
- Recover condition: The bus voltage is lower than the high bus voltage protection threshold.
- Reset method: Resume automatically after the error exit condition is reached.

3.6.4 Possible causes

- The input voltage is too high, resulting in the high bus voltage;
- The power grid voltage is too high;
- The bus voltage detection circuit of the module is abnormal:

3.6.5 Procedure

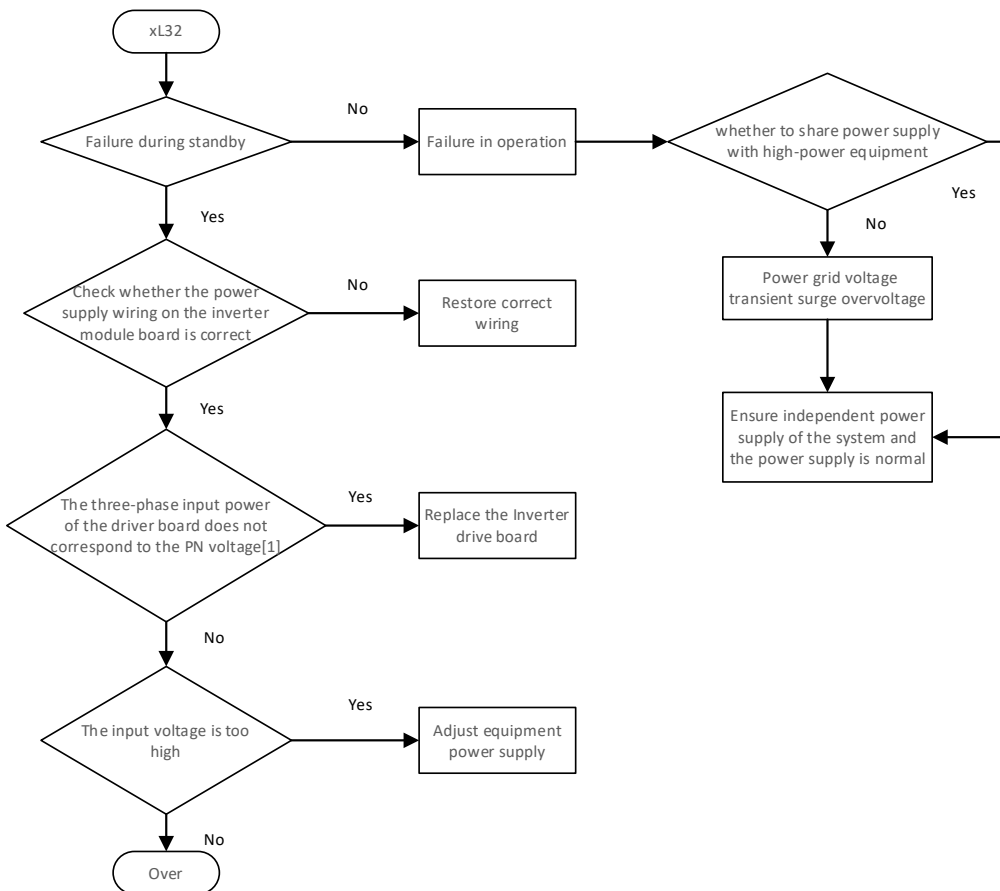

Notes:

[1] $V_{dc} = V_{AC} * 1.732$, such as the corresponding PN $V_{dc} = 540V_{DC}$ for the 380V input.

3.7 xL43: The current sampling bias is abnormal.

3.7.1 Digital display output



3.7.2 Description

- Bias calibration of the current sampling circuit is in error.
- After this error occurs, the compressor cannot start. Check whether the inverter driver board is in error.

3.7.3 Trigger / recover condition

- Trigger condition: The AD bias value of the current sampling circuit exceeds half of the AD value range.
- Recover condition: The AD bias value of the current sampling circuit is less than half of the AD range.
- Reset method: Resume automatically.

3.7.4 Possible causes

- The sampling circuit of the inverter drive board is abnormal

3.7.5 Procedure

- Replace the inverter drive board.

3.8 xL5E: Startup failed

3.8.1 Digital display output

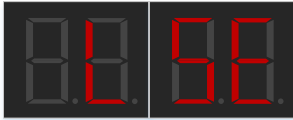

3.8.2 Description

- The compressor fails to start
- The compressor stops running after the error occurs. If the error disappears one minute later, the compressor starts again.

3.8.3 Trigger / recover condition

- Trigger condition: The compressor fails to start
- Recover condition: If the compressor fails to start and starts again successfully, the error will be rectified.
- Reset method: Resume automatically.

3.8.4 Possible causes

- Discharge pressure and suction pressure of compressor is different when start up:
- The compressor is stuck:

3.8.5 Procedure

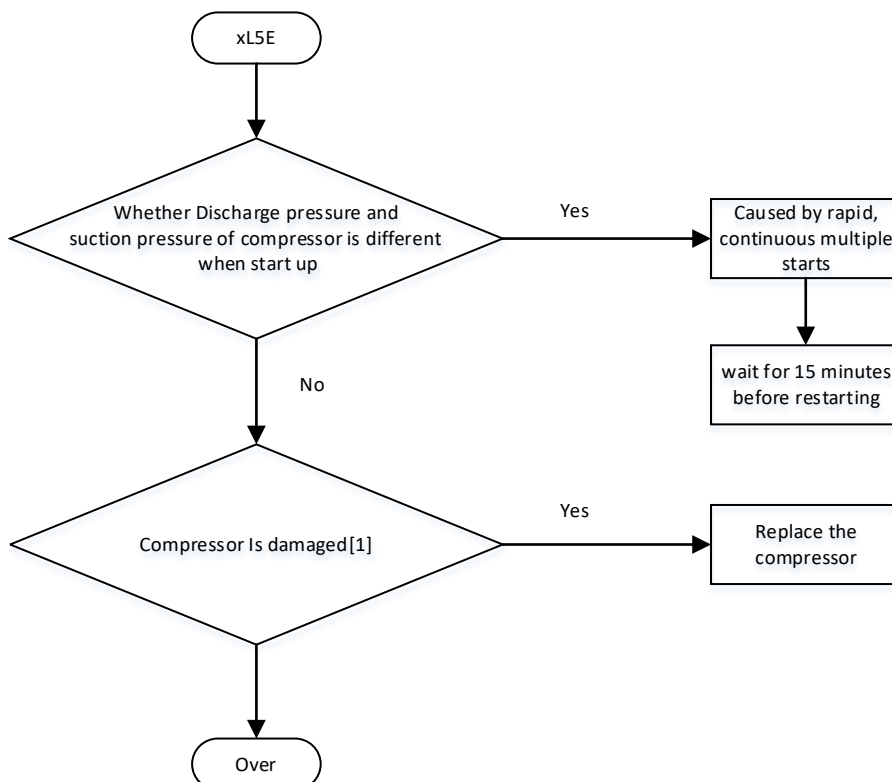

Note:

[1] Abnormal sound or shaking in compressor when startup (Compressor stuck cylinder, or Impurities in the system)

3.9 xL52: Locked-rotor protection

3.9.1 Digital display output



3.9.2 Description

- The compressor is blocked.
- The compressor stops running after the error occurs. If the error disappears one minute later, the compressor starts again.

3.9.3 Trigger / recover condition

- Trigger condition: The compressor is blocked.
- Recover condition: The blocking error is removed.
- Reset method: Resume automatically after the error exit condition is reached.

3.9.4 Possible causes

- The compressor is blocked due to impurities or lack of oil in the system.

3.9.5 Procedure

- Matching normal and faulty compressors if possible and replace the two compressors if the problem persists

3.10 xL6E: Compressor motor lack of phase protection

3.10.1 Digital display output



3.10.2 Description

- Compressor motor lack of phase protection.
- The compressor stops running after the error occurs. If the error disappears one minute later, the compressor starts again.

3.10.3 Trigger / recover condition

- Trigger condition: The compressor cable is not connected or in poor contact.
- Recover condition: Check the cable connection of the compressor. After the cable connection is good, the error of missing phase protection is removed and recovered.
- Reset method: Resume automatically after the error exit condition is reached.

3.10.4 Possible causes

- The compressor cable is in poor contact or the terminal screw is not tightened.
- The inverter drive board is abnormal:

3.10.5 Procedure

- ① Check the UVW output connection line of the inverter drive board and the UVW connection line of the compressor:
- ② If possible connect the compressor with a normal inverter driver board to verify whether the original driver board is normal. If not, replace the inverter drive board.

4 Error in Fan Drive

4.1 xJ1E: Hardware overcurrent

4.1.1 Digital display output

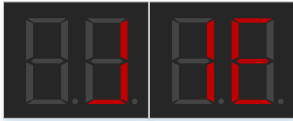

4.1.2 Description

- The current exceeds the OCP protection value (peak value) set by the hardware or the IPM module receives an FO signal
- The fan stops running after the error occurs. If the error disappears five seconds, the fan starts again

4.1.3 Trigger / recover condition

(1)Current reaches OCP protection value:

- Trigger condition:Current reaches OCP protection value
- Recover condition:The fan will stop after failure, and recover after five seconds when the condition of failure exit is reached
- Reset method:The system automatically recovers five seconds after the error exit condition is reached

(2)Falling edge of FO signal or continuous low level is detected:

- Trigger condition: A falling edge or continuous low level of FO signal is detected.
- Recover condition: The FO signal becomes high level.
- Reset method: Resume automatically five seconds after the error exit condition is reached.

4.1.4 Possible causes

- The software out of control leads to fan running stall
- The fan is blocked or the internal coil is short-circuited
- The IPM of Inverter drive board(fan section) is damaged
- The circuits of Inverter drive board(fan section) are abnormal

4.1.5 Procedure

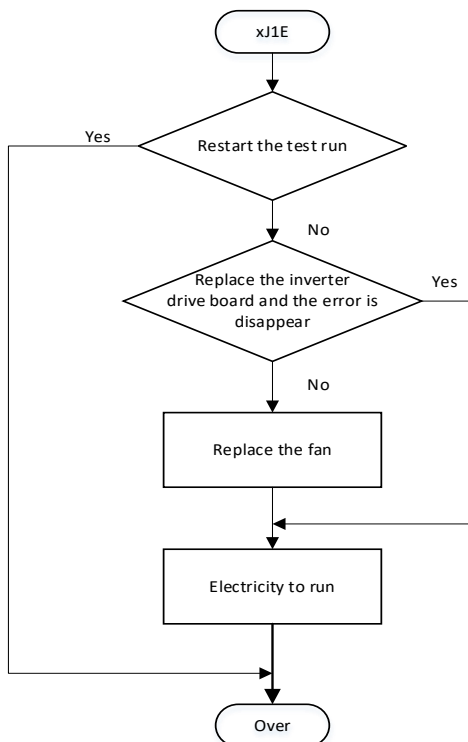

4.2 xJ11, xJ12: Software overcurrent

4.2.1 Digital display output



4.2.2 Description

- The current exceeds the OCP protection value set by the software.
- The fan will stop when the error occurs. If the error disappears five seconds later, the fan will start again.

4.2.3 Trigger / recover condition

- Trigger condition:
 - xJ11: The fan current exceeds the OCP protection value set by the software in three consecutive carrier periods
 - xJ12: Software overcurrent protection last 30s
- Recover condition: The fan will stop when the error occurs. If the error disappears five seconds later, the fan will start again
- Reset method: Resume automatically after reaching exit condition of Error

4.2.4 Possible causes

- Severe fan wear.
- The software out of control leads to fan running stall.
- The driver or detection part of the inverter drive board is damaged.

4.2.5 Procedure

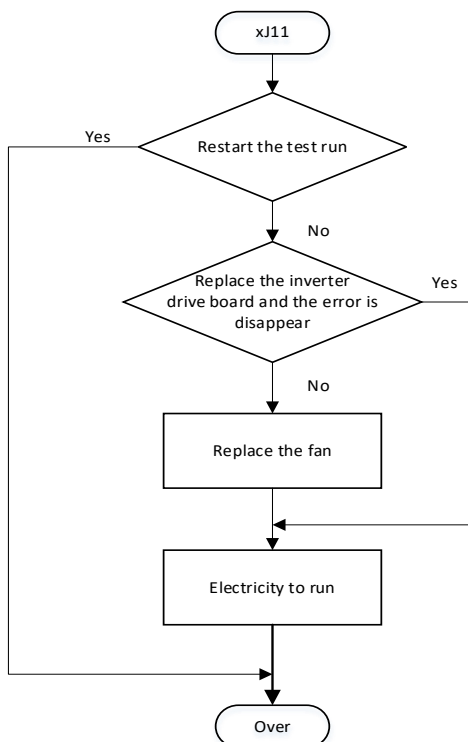

4.3 xJ2E: Module overtemperature protection

4.3.1 Digital display output



4.3.2 Description

- The temperature of the IPM exceeds 105° .
- The fan stops running after the error. If the error disappears after five seconds, the fan starts again.

4.3.3 Trigger / recover condition

- Trigger condition: The temperature of the IPM exceeds 105 ° C
- Recover condition: After a error occurs, the fan is shut down. The fan will recover five seconds later when the error exit condition is reached (the module temperature is lower than 105 ° C).
- Reset method: Resume automatically after the error exit condition is reached.

4.3.4 Possible causes

- The IPM screws are not tightened, resulting in poor heat dissipation:
- The heat dissipation silicone for the IPM module is not evenly applied, resulting in poor heat dissipation:
- The IPM temperature detection circuit is abnormal

4.3.5 Procedure

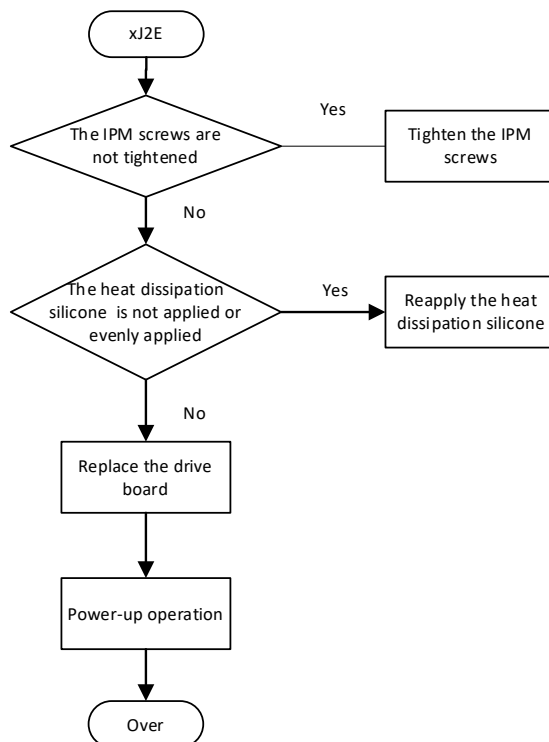

4.4 xJ3E: The bus voltage is too low

4.4.1 Digital display output



4.4.2 Description

- Bus voltage is lower than the low bus voltage protection threshold set by the software (350VDC).
- The fan stops running after the error occurs. If the error disappears five seconds later, the fan starts again.

4.4.3 Trigger / recover condition

- Trigger condition: The bus voltage is lower than the bus voltage protection threshold set by the software.
- Recover condition: The bus voltage is higher than the low bus voltage protection threshold set by the software
- Reset method: Resume automatically after the error exit condition is reached.

4.4.4 Possible causes

- The input voltage is too low, resulting in the low bus voltage:
- Voltage sag or interruption, resulting in transient bus voltage is too low:
- The bus voltage detection circuit of the module is abnormal:

4.4.5 Procedure

Troubleshoot according to xL3E

4.5 xJ31: The bus voltage is too high

4.5.1 Digital display output



4.5.2 Description

- Bus voltage is higher than the high bus voltage protection threshold set by the software (800VDC).
- The fan stops running after the error occurs. If the error disappears five seconds later, the fan starts again.

4.5.3 Trigger / recover condition

- Trigger condition: The bus voltage is higher than the software overvoltage protection threshold.
- Recover condition: The bus voltage is lower than the overvoltage protection threshold set by the software.
- Reset method: Resume automatically after the error exit condition is reached.

4.5.4 Possible causes

- The input voltage is too high, resulting in the high bus voltage;
- The power grid voltage is too high;
- The bus voltage detection circuit of the module is abnormal;

4.5.5 Procedure

Troubleshooting according to xL31

4.6 xJ32: The bus voltage is excessively high

4.6.1 Digital display output



4.6.2 Description

- Bus voltage is higher than the high bus voltage protection threshold set by the software (820VDC).
- The fan stops running after the error occurs. If the error disappears five seconds later, the fan starts again.

4.6.3 Trigger / recover condition

- Trigger condition: The bus voltage is too high, higher than the high bus voltage protection threshold set by the software (820VDC)
- Recover condition: The bus voltage is lower than the high bus voltage protection threshold.
- Reset method: Resume automatically after the error exit condition is reached.

4.6.4 Possible causes

- The input voltage is too high, resulting in the high bus voltage;
- The power grid voltage is too high:
- The bus voltage detection circuit of the module is abnormal:

4.6.5 Procedure

Troubleshooting according to xL32

4.7 xJ43: The current sampling bias is abnormal

4.7.1 Digital display output



4.7.2 Description

- Bias calibration of the current sampling circuit is in error.ias calibration of the current sampling circuit is in error.
- After this error occurs, the fan cannot start. Check whether the inverter driver board is in error.

4.7.3 Trigger / recover condition

- Trigger condition: The AD bias value of the current sampling circuit exceeds half of the AD value range.
- Recover condition: The AD bias value of the current sampling circuit is less than half of the AD range.
- Reset method: Resume automatically after the error exit condition is reached.

4.7.4 Possible causes

- The sampling circuit of the inverter drive board is abnormal

4.7.5 Procedure

- Replace the inverter drive board

4.8 xJ5E: Startup failed

4.8.1 Digital display output



4.8.2 Description

- The fan fails to be started.
- The fan stops running after the error. If the error disappears after five seconds, the fan starts again.

4.8.3 Trigger / recover condition

- Trigger condition: Fan startup failure.
- Recover condition: If the fan fails to start, the fan restarts again and the error is rectified after the fan starts successfully.
- Reset method: Resume automatically after the fan starts successfully.

4.8.4 Possible causes

- fan motor stuck:
- The fan is started against the wind:
- The driver is abnormal:

4.8.5 Procedure

- ① Check whether the motor is stuck:
- ② Check whether there is a large headwind:
- ③ If possible, connecting a normal inverter drive board and the fan with error, check whether the fan is normal. Otherwise, replace the fan.

4.9 xJ52: Locked-rotor protection

4.9.1 Digital display output



4.9.2 Description

- The fan is blocked.
- The fan stops running after the error. If the error disappears after five seconds, the fan starts again.

4.9.3 Trigger / recover condition

- Trigger condition: The fan is blocked.
- Recover condition: The blocking error is removed.
- Reset method: Resume automatically after the error exit condition is reached.

4.9.4 Possible causes

- The fan shaft is stuck.

4.9.5 Procedure

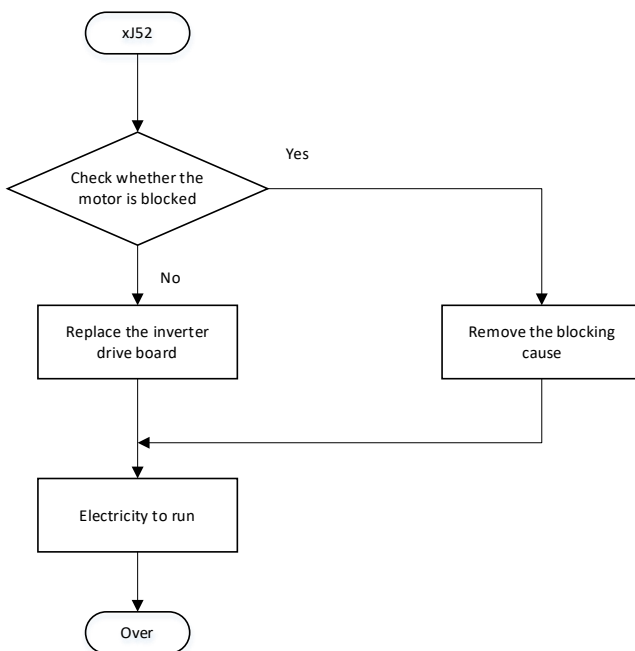

4.10 xJ6E: Motor lack of phase protection

4.10.1 Digital display output

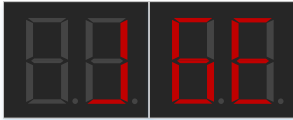

4.10.2 Description

- The fan has phase loss protection.
- The fan stops running after the error. If the error disappears after five seconds, the fan starts again.

4.10.3 Trigger / recover condition

- Trigger condition: The fan cable is not connected or in bad contact.
- Recover condition: Check the fan wiring, after the wiring is good, the error of missing phase protection is removed.
- Reset method: Resume Automatically after the error exit condition is reached

4.10.4 Possible causes

- The compressor cable is in poor contact or the terminal screw is not tightened.
- The IPM of inverter drive board is damaged:

4.10.5 Procedure

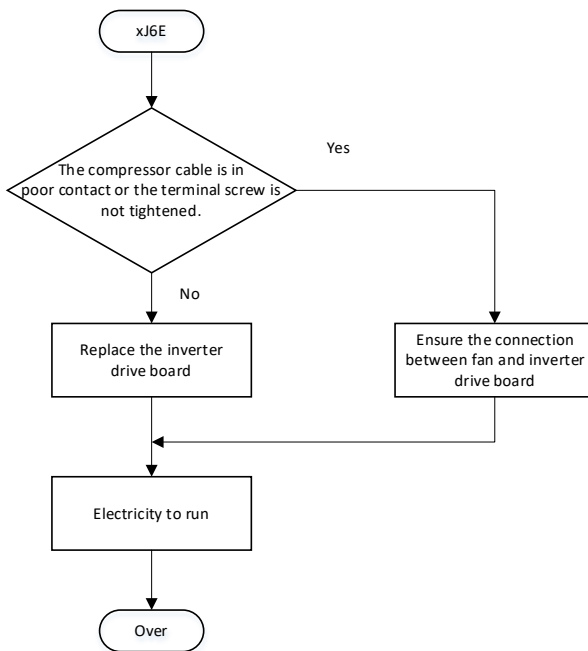

5 Appendix

5.1 Resistance characteristics of temperature sensor

Table 6-5.1: Temperature probe symbol and position

Temperature probe symbol and position		The probe type
T3	Bottom of heat exchanger	Type A
T4	Outdoor ambient temperature	Type A
T5	Liquid pipe stop valve	Type A
T6A	Microchannel heat exchanger inlet pipe	Type A
T6B	Microchannel heat exchanger outlet pipe	Type A
T71	Inverter compressor A suction	Type A
T7C1	Inverter compressor A discharge	Type B
T8	Outdoor Heat exchanger gas pipe	Type A
TL	Outdoor Heat exchanger liquid pipe	Type A
Tg	Gas pipe stop valve	Type A
Tb	Electric control box cavity	Type A
Tr	Sampling resistance of inverter drive board	Type C
NTC	inverter drive board	Type C

Notes: Type A is mainly used for general pipe temperature and ambient temperature detection

Type B is mainly used for compressor discharge temperature detection

TypeC is mainly used for internal temperature detection of electronic control board

Table 6-5.2: Temperature sensor temperature resistance characteristic table

temperature (°C)	resistance (kΩ)		
	Type A	Type B	Type C
-20	115.3	542.7	532.2
-19	108.1	511.9	502.2
-18	101.5	483	474.1
-17	96.34	455.9	447.7
-16	89.59	430.5	423
-15	84.22	406.7	399.8
-14	79.31	384.3	378
-13	74.54	363.3	357.5
-12	70.17	343.6	338.2
-11	66.09	325.1	320.1
-10	62.28	307.7	303.1
-9	58.71	291.3	287.1
-8	56.37	275.9	272
-7	52.24	261.4	257.8
-6	49.32	247.8	244.4
-5	46.57	234.9	231.9
-4	44	222.8	220
-3	41.59	211.4	208.7
-2	39.82	200.7	198.2
-1	37.2	190.5	188.2
0	35.2	180.9	178.8

Table 6-5.2: Temperature sensor temperature resistance characteristic table (continues)

temperature (°C)	resistance (kΩ)		
	Type A	Type B	Type C
1	33.33	171.9	169.9
2	31.56	163.3	161.5
3	29.91	155.2	153.6
4	28.35	147.6	146.1
5	26.88	140.4	139.1
6	25.5	133.5	132.3
7	24.19	127.1	126
8	22.57	121	120
9	21.81	115.2	114.3
10	20.72	109.8	109
11	19.69	104.6	103.9
12	18.72	99.69	99.02
13	17.8	95.05	94.44
14	16.93	90.66	90.11
15	16.12	86.49	86
16	15.34	82.54	82.09
17	14.62	78.79	78.38
18	13.92	75.24	74.87
19	13.26	71.86	71.53
20	12.64	68.66	68.36
21	12.06	65.62	65.34
22	11.5	62.73	62.47
23	10.97	59.98	59.75
24	10.47	57.37	57.17
25	10	54.89	54.71
26	9.551	52.53	52.36
27	9.124	50.28	50.13
28	8.72	48.14	48.01
29	8.336	46.11	45.99
30	7.971	44.17	44.07
31	7.624	42.33	42.23
32	7.295	40.57	40.48
33	6.981	38.89	38.81
34	6.684	37.3	37.23
35	6.4	35.78	35.71
36	6.131	34.32	34.27
37	5.874	32.94	32.89
38	5.63	31.62	31.58
39	5.397	30.36	30.33
40	5.175	29.15	29.13
41	4.964	28	27.98
42	4.763	26.9	26.89
43	4.571	25.86	25.85

Table 6-5.2: Temperature sensor temperature resistance characteristic table (continues)

temperature (°C)	resistance (kΩ)		
	Type A	Type B	Type C
44	4.387	24.85	24.85
45	4.213	23.89	23.9
46	4.046	22.89	22.98
47	3.887	22.1	22.1
48	3.735	21.26	21.26
49	3.59	20.46	20.47
50	3.451	19.69	19.7
51	3.318	18.96	18.97
52	3.192	18.26	18.26
53	3.071	17.58	17.59
54	2.959	16.94	16.94
55	2.844	16.32	16.32
56	2.738	15.73	15.73
57	2.637	15.16	15.16
58	2.54	14.62	14.62
59	2.447	14.09	14.1
60	2.358	13.59	13.6
61	2.272	13.11	13.12
62	2.191	12.65	12.65
63	2.112	12.21	12.22
64	2.037	11.79	11.79
65	1.965	11.38	11.39
66	1.896	10.99	10.99
67	1.83	10.61	10.62
68	1.766	10.25	10.25
69	1.705	9.902	9.909
70	1.647	9.569	9.576
71	1.591	9.248	9.253
72	1.537	8.94	8.947
73	1.485	8.643	8.646
74	1.435	8.358	8.362
75	1.387	8.084	8.089
76	1.341	7.82	7.821
77	1.291	7.566	7.569
78	1.254	7.321	7.323
79	1.2133	7.086	7.088
80	1.174	6.859	6.858
81	1.136	6.641	6.64
82	1.1	6.43	6.432
83	1.064	6.228	6.23
84	1.031	6.033	6.033
85	0.9982	5.844	5.847
86	0.9668	5.663	5.667

Table 6-5.2: Temperature sensor temperature resistance characteristic table (continues)

temperature (°C)	resistance (kΩ)		
	Type A	Type B	Type C
87	0.9366	5.488	5.492
88	0.9075	5.32	5.322
89	0.8795	5.157	5.159
90	0.8525	5	5
91	0.8264	4.849	4.855
92	0.8013	4.703	4.705
93	0.7771	4.562	4.566
94	0.7537	4.426	4.431
95	0.7312	4.294	4.301
96	0.7094	4.167	4.176
97	0.6884	4.045	4.055
98	0.6682	3.927	3.938
99	0.6486	3.812	3.825
100	0.6297	3.702	3.716
101	0.6115	3.595	3.613
102	0.5939	3.492	3.514
103	0.5768	3.392	3.418
104	0.5604	3.296	3.326
105	0.5445	3.203	3.235
106	0.5291	3.113	3.148
107	0.5143	3.025	3.063
108	0.4999	2.941	2.982
109	0.486	2.86	2.902
110	0.4726	2.781	2.826
111	0.4596	2.704	2.747
112	0.447	2.63	2.672
113	0.4348	2.559	2.599
114	0.423	2.489	2.528
115	0.4116	2.422	2.46
116	0.4006	2.357	2.39
117	0.3899	2.294	2.322
118	0.3796	2.233	2.256
119	0.3695	2.174	2.193
120	0.3598	2.117	2.132
121	0.3504	2.061	2.073
122	0.3413	2.007	2.017
123	0.3325	1.955	1.962
124	0.3239	1.905	1.91
125	0.3156	1.856	1.859
126	0.3075	1.808	
127	0.2997	1.762	
128	0.2922	1.717	
129	0.2848	1.674	

Table 6-5.2: Temperature sensor temperature resistance characteristic table (continues)

temperature (°C)	resistance (kΩ)		
	Type A	Type B	Type C
130	0.2777	1.632	
131	0.2708		
132	0.2641		
133	0.2576		
134	0.2513		
135	0.2451		

5.2 Normal status parameter of refrigerant system

The parameters listed in Tables 5.2.1 and 5.2.2 need to be noted when the following conditions are met::

- The master can detect all indoor machines:
- The number of indoor units displayed for outdoor units is consistent with the actual installation.
- All stop valves have been opened and all indoor units' electronic expansion valve have been connected to their main control board:
- If the indoor unit connection rate is less than 100% and all indoor units are running.If the connection rate of the indoor unit is greater than 100%, the operating capacity of the indoor units is equal to the total capacity of the outdoor units.
- If the outdoor ambient temperature is high, and the system is in cooling mode and set the temperature to 17 ° C with high wind speed;
- If the outdoor ambient temperature is low, and the system is in heating mode and set to 30 ° C, high wind speed:
- The system runs properly for more than 30 minutes

Table 6-5.3: outdoor unit cooling mode parameters

Outdoor ambient temperature	°C	< 10	10 to 26	26 to 31	31 to 41	> 41
Discharge temperature	°C	60-76	62-78	65-82	67-92	69-92
Discharge superheat	°C	17-30	17-33	17-34	17-36	10-32
discharge pressure	MPa	2.3-2.8	2.3-2.8	2.4-3.6	2.6-3.8	3.1-4.1
suction pressure	MPa	0.6-0.7	0.7-0.9	0.8-1.0	1.0-1.2	1.2-1.4
Dc bus compressor current	A	9-32	11-38	20-44	26-44	20-46

Table 6-5.4: outdoor unit heating mode parameters

Outdoor temperature	°C	< -10	-10 to 10	0 to 5	5 to 10	10 to 17	> 17
Discharge temperature	°C	56-74	57-76	58-78	61-82	63-82	63-82
Discharge superheat	°C	17-35	17-35	17-35	17-33	14-33	14-33
discharge pressure	MPa	1.7-2.4	1.8-2.5	1.9-3.0	2.2-3.2	2.3-3.2	2.3-3.2
Back to the gas pressure	MPa	0.4-1.0	0.5-1.2	0.5-1.2	0.5-1.3	0.5-1.3	0.6-1.4
Dc bus compressor current	A	14-38	15-38	16-30	20-40	18-42	12-35

5.3 Analysis of the cause of system anomalies

5.3.1 Cause Analysis of Excessive discharge Temperature

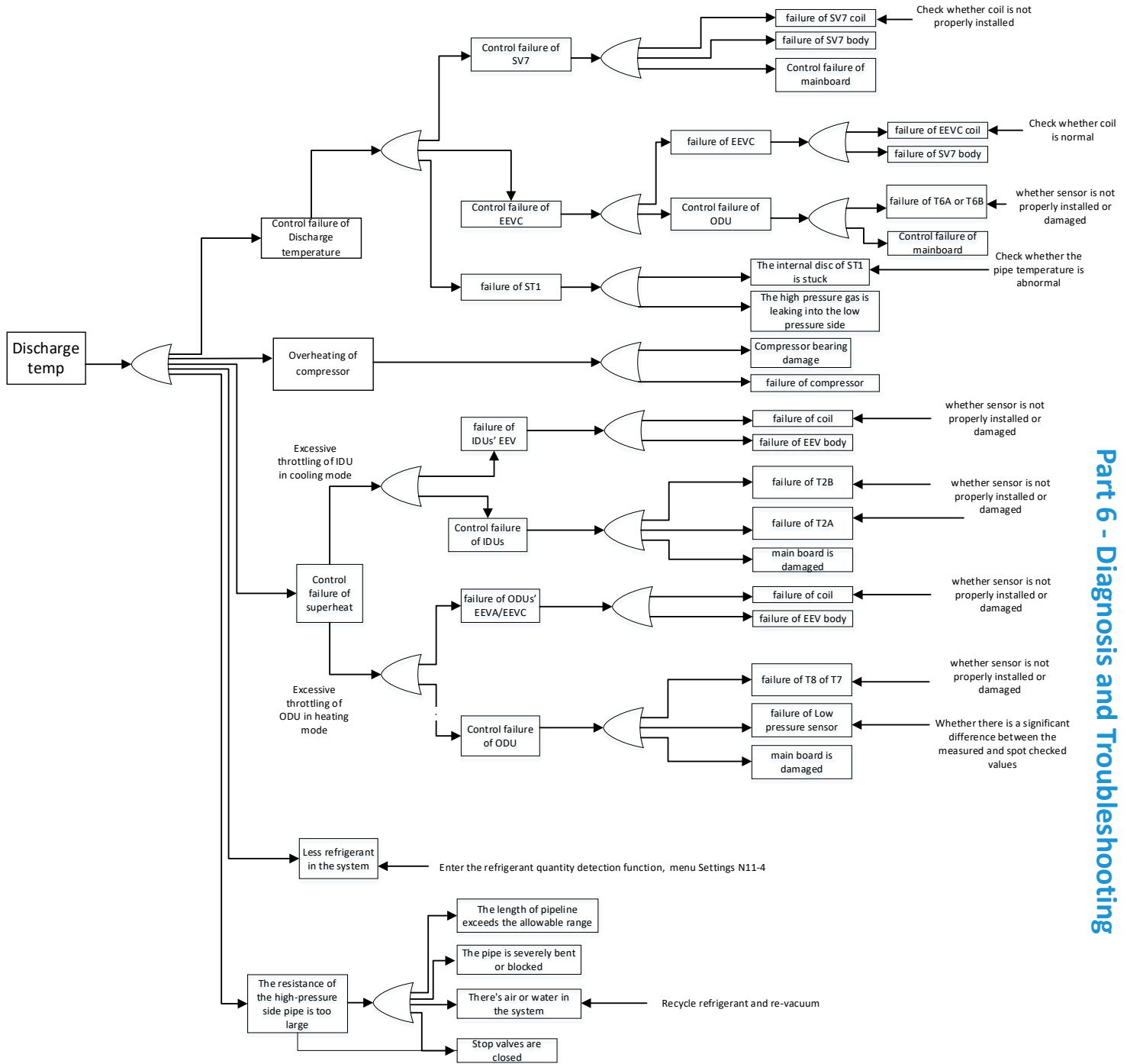

5.3.2 Cause Analysis of too high Pressure

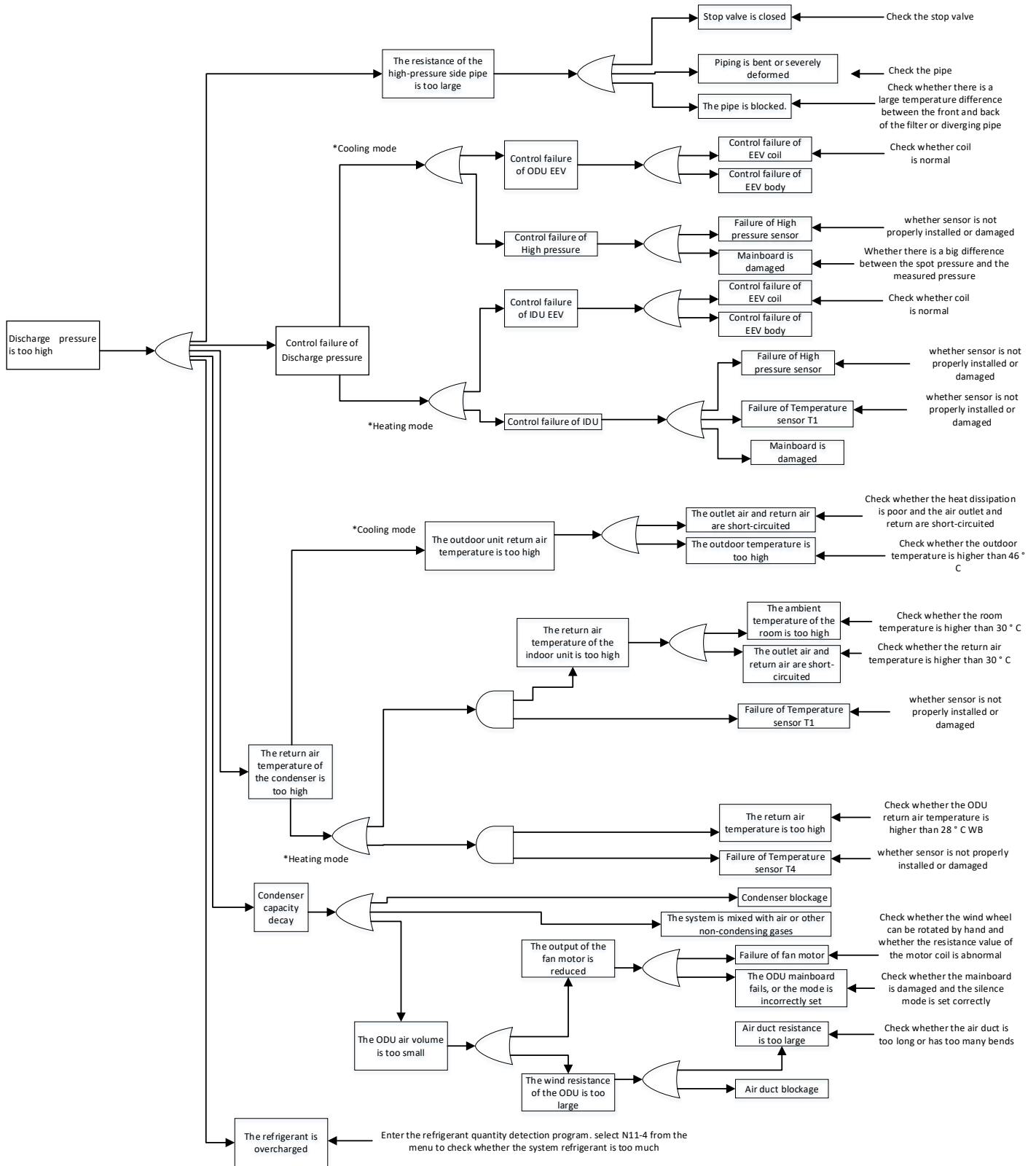

5.3.3 Cause Analysis of too Low Pressure

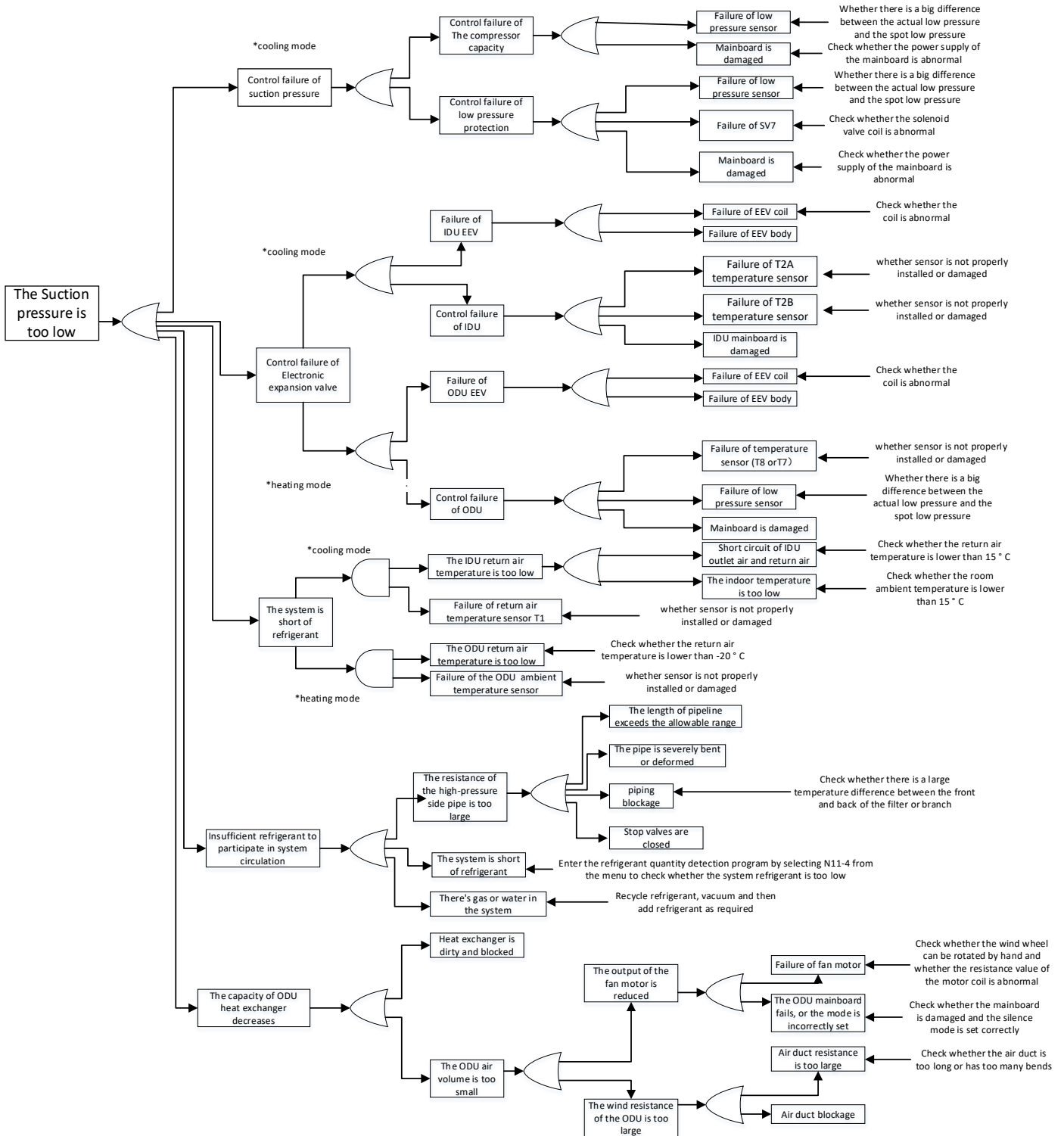

5.4 Outdoor unit main Control Board ports table

Figure 6-5.1: Outdoor unit main Control Board ports

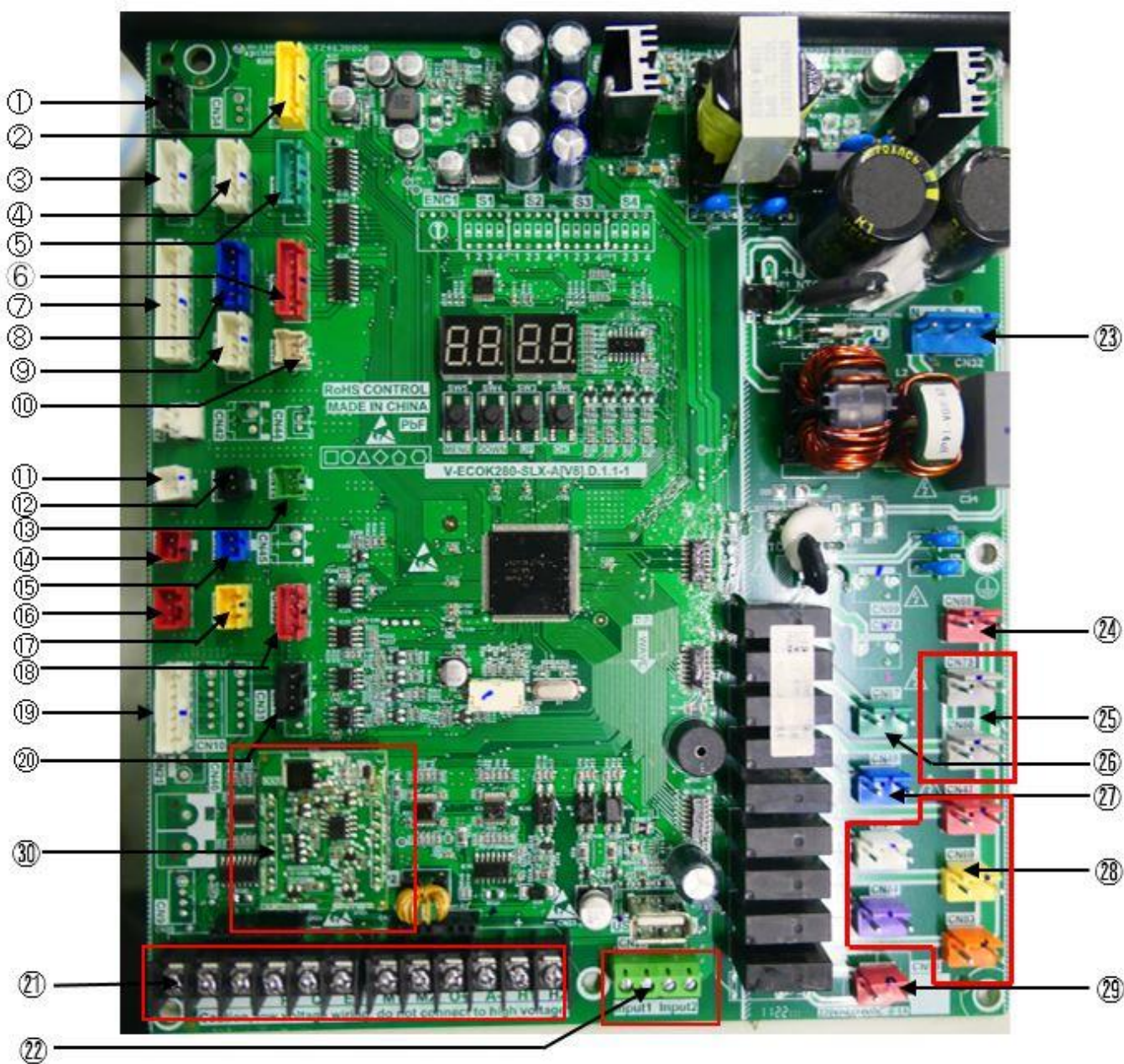

Table 6-5.5: Main Control Board port definition Table

Label in Figure 5-2.1	Port code	Content	Port voltage
1	CN82	Reserved	5Vdc
2	CN36	Reserved	3.3Vdc
3	CN70	EEVA drive port	12Vdc
4	CN71	EEVB drive port(Reserved)	12Vdc
5	CN72	EEVC drive port	12Vdc
6	CN73	EXVE drive port	12Vdc
7	CN4	Microchannel heat exchanger inlet temperature sensor(T6A) /Liquid pipe inlet temperature sensor(T5) /Microchannel heat exchanger outlet temperature sensor(T6B) /Suction temperature sensor 1 (T71) /Discharge temperature sensor 1 (T7C1) (From top to bottom)	3.3Vdc
8	CN35	Electric control box chamber Temperature & Humidity sensor(Tb)	3.3Vdc
9	CN8	Condenser inlet temperature sensor(T8)/Main exchanger pipe temperature sensor(T3) (From top to bottom)	3.3Vdc
10	CN3	Condenser outlet temperature sensor(TL)	3.3Vdc
11	CN16	Gas pipe temperature sensor(Tg)	3.3Vdc
12	CN38	Reserved	3.3Vdc
13	CN11	Reserved	3.3Vdc
14	CN37	Reserved	3.3Vdc
15	CN30	Outdoor ambient temperature sensor(T4)	3.3Vdc
16	CN41	Low pressure sensor	5Vdc
17	CN40	High pressure sensor	5Vdc
18	CN33	Expanded communication port	12Vdc
19	CN26	Communication port to Compressor & Fan Drive Board	5Vdc+12Vdc
20	CN14	Communication port to data transfer module	12Vdc
21	CN22/CN23	Communication port	0-5V DC (varying)
22	CN28	Emergency stop port	0V or Open
23	CN32	Power input of main board	176Vac~264Vac
24	CN68	Reserved	176Vac~264Vac
25	CN75/CN66	Power supply to compressor crankcase heater	176Vac~264Vac
26	CN67	Solenoid valve drive ports (Reserved)	176Vac~264Vac
27	CN48	Four-way valve drive ports(ST1)	176Vac~264Vac
28	CN47 /CN49/CN69 /CN84/CN83	Solenoid valve drive ports CN47-SV6 ; CN49-SV5 ; CN69-SV7 ; CN84-SV8A; CN83-SV8B	176Vac~264Vac
29	CN93	Dry contact output	0V or Open
30	-	HyperLink board	-

5.5 Compressor & Fan drive board ports detection

5.5.1 Port reference and function definition of Compressor & Fan drive board

Figure 6-5.2: Compressor & Fan drive board ports

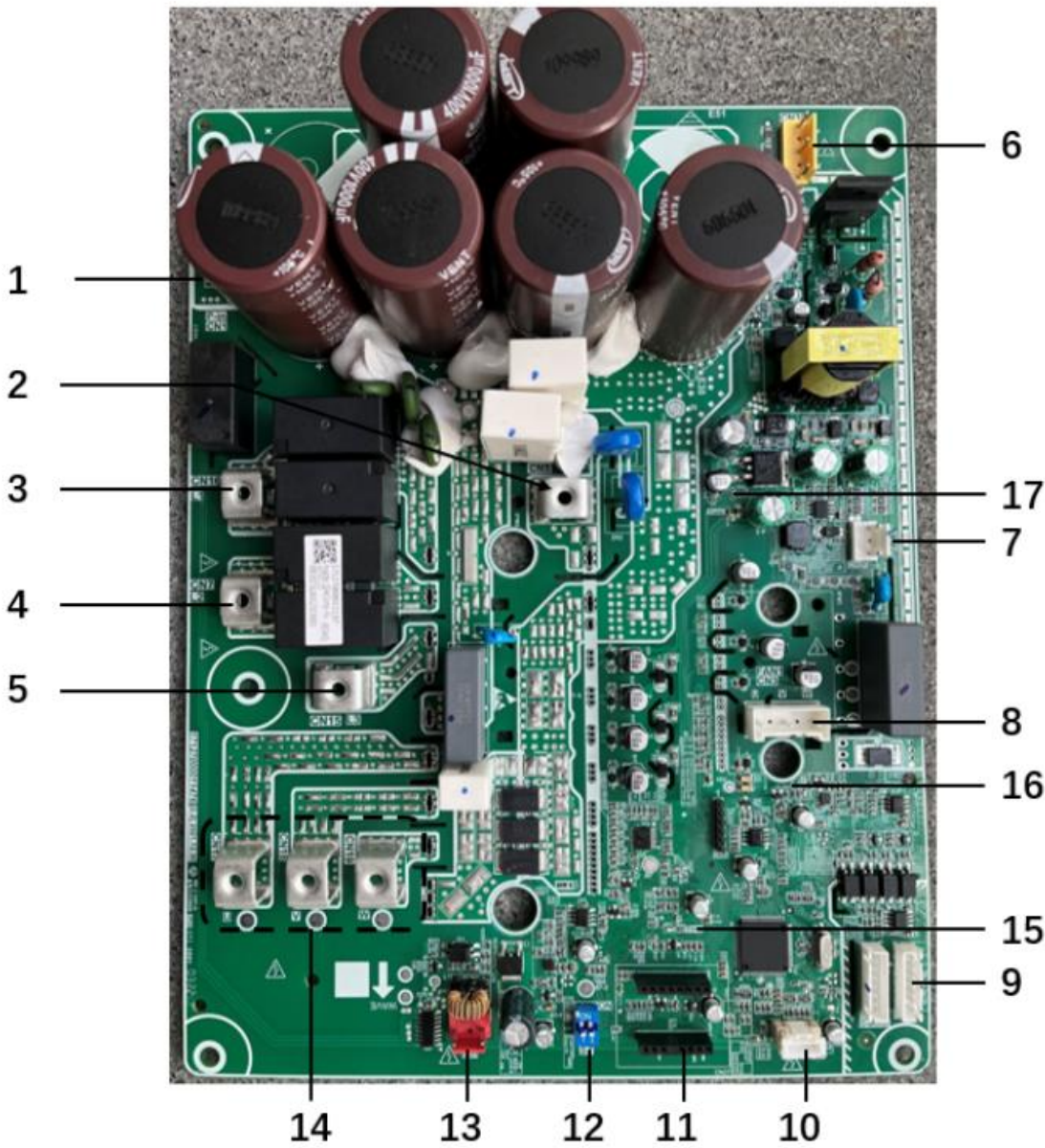

Table 6-5.5: Port definition and functions table:

Label in Figure 6-2.5	Port code	Feature identifier	Content	Port voltage
1	CN1	P-in	Positive pole Input terminal of the high voltage capacitors (connected to reactor)	438Vdc-650Vdc(Rated at 540Vdc)
2	CN5	P-out	Positive pole output terminal of the three-phase rectifier (connected to reactor)	438Vdc-650Vdc(Rated at 540Vdc)
3	CN16	L1	Three phase power input of L1 phase	310Vac-460Vac(Rated 380Vac between phases)
4	CN7	L2	Three phase power input of L2 phase	310Vac-460Vac(Rated 380Vac between phases)
5	CN15	L3	Three phase power input of L3 phase	310Vac-460Vac(Rated 380Vac between phases)

Table 6-5.5: Port definition and functions table (continues):

Label in Figure 6-2.5	Port code	Feature identifier	Content	Port voltage
6	CN38	-	Power supply terminal for DC fan drive board (P,N) (Reserved)	438Vdc~650Vdc(Rated 540Vdc; P is positive, N is negative)
7	CN26	-	Fan module controls power supply(Reserved)	19V
8	CN3	DCFAN	Three phase output of the inverter ,connected to the DC fan	0~100%*input voltage(varying)
9	CN8/CN9	O-Motor	Communication port between main control board and Inverter drive board	Ports from top to bottom are defined as follows: 5V, +, -, GND, 12V, empty, and Ry2.
10	CN25	-	Debug port	--
11	CN27	-	PED Diagnostic Module	--
12	S7	-	Dial switches of address setting (Compressor & Fan drive module)	--
13	CN21	H-Pro	High pressure switch connection	Close: 0 Vdc ; Open: 6 Vdc
14	CN17/18/19	U/V/W	Three phase output of the inverter ,connected to the compressor	0~100%*input voltage(varying)
15	LED1	COMP	Compressor drive status indicator: red, steady on indicates running, slow blinking indicates standby, and quick blinking indicates error (see the specific error code of the nixie tube on the main board)	--
16	LED2	Fan	Fan drive status indicator: red, steady on means running, slow blinking means standby, quick blinking means error code (see the specific error code of the nixie tube on the main board)	--
17	LED3	Power	Drive board 5V control power indicator light, green, 5V power is always on.Note That there may be residual high voltage on the drive board when the indicator is off. Use a multimeter to measure and confirm the operation.	--

5.5.2 Fan drive board

Figure 6-5.3: Fan drive board

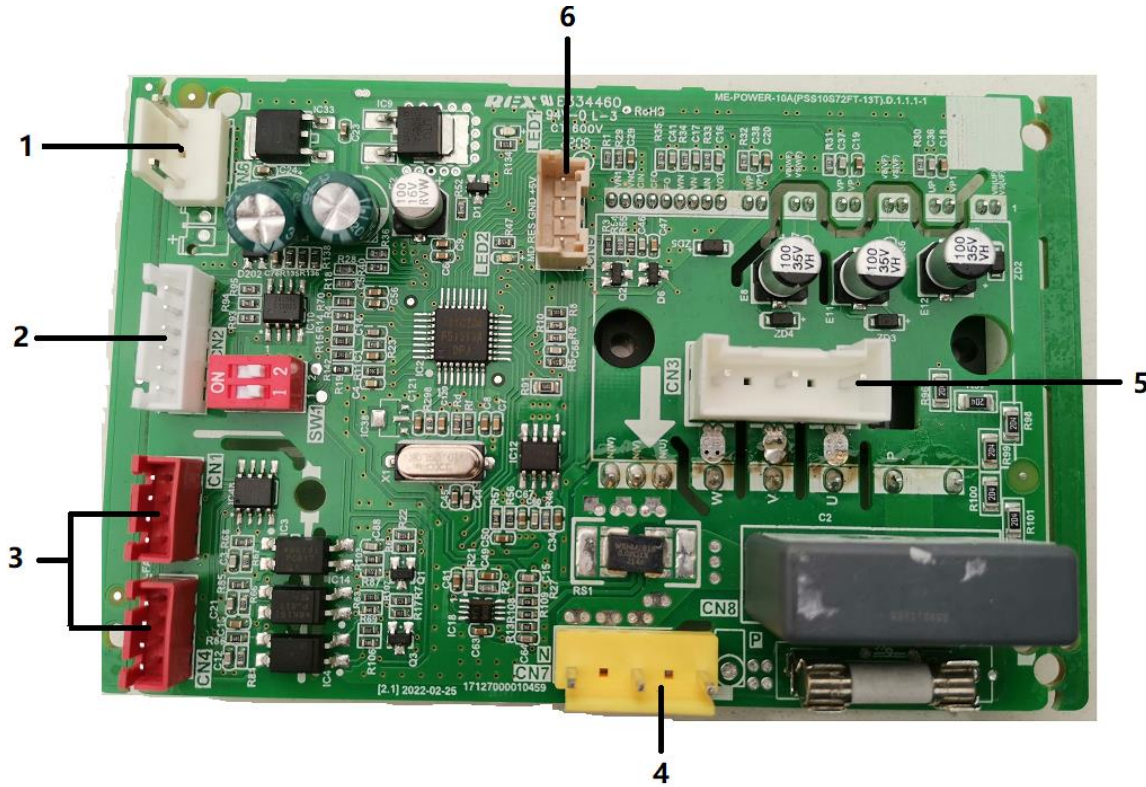

Table 6-5.6: Compressor & Fan drive board port

Label in Figure 5-2.5	Port code	Content	Port voltage
1	CN6	Fan module controls power supply(Reserved)	19V
2	CN2	EEPROM Program burning port	5V
3	CN4\CN1	Communication port between main control board and Fan drive board	5V
4	CN7	Power supply terminal for DC fan drive board (P,N) From main control board.	Rated voltage 540V DC P(+), N(-)
5	CN3	Output power supply for fan motor	46~460V AC
6	CN9	Main Program burning port	--

5.5.3 Inverter drive board measurement guidelines

Please give priority to the following things before testing Inverter drive board:

- 1) Cut off the power supply:
- 2) To avoid electric shock from capacitor discharge, power off for 10 minutes and wait for capacitor discharge before operation:
- 3) Remove all wiring on the Inverter drive board.

Tools: multimeter (measurable secondary pipe)

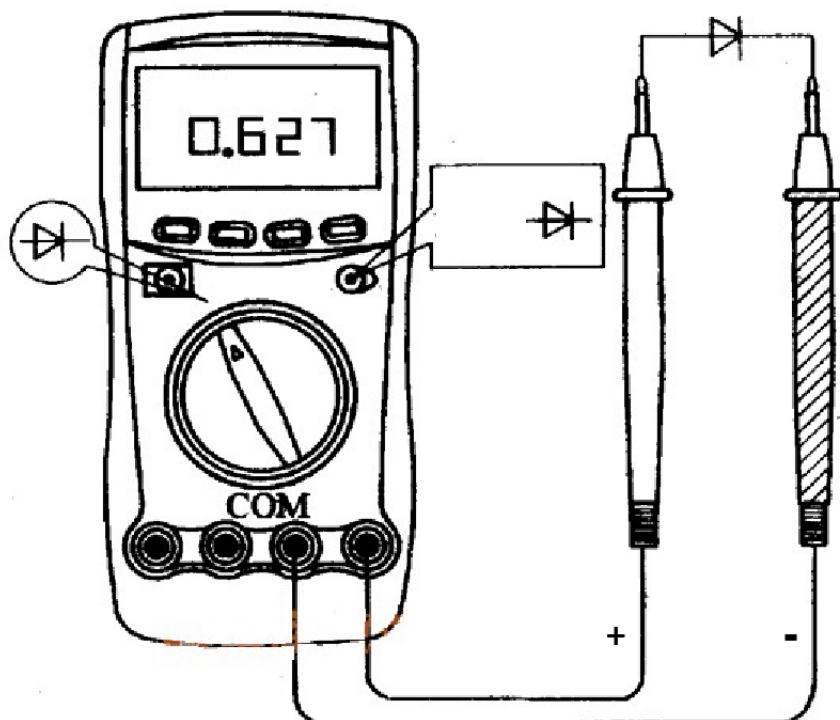

The following measurements are for reference:

Inverter circuit measurement

Number	Test point		Normal decision value	Notes
	+(Red)	-(Black)		
1	U	P-in	0.3-0.7V	0 or $\rightarrow + \infty$ is abnormal
2	V	P-in		
3	W	P-in		
4	N	U		
5	N	V		
6	N	W		

Rectifier bridge stack measurement

Number	Test point		Normal decision value	Notes
	+(Red)	-(Black)		
1	L1'	P-out	0.3-0.7V	0 or $\rightarrow + \infty$ is abnormal
2	L2'	P-out		
3	L3'	P-out		
4	N	L1'		
5	N	L2'		
6	N	L3'		

Schematic diagram of measuring points of Inverter drive board:

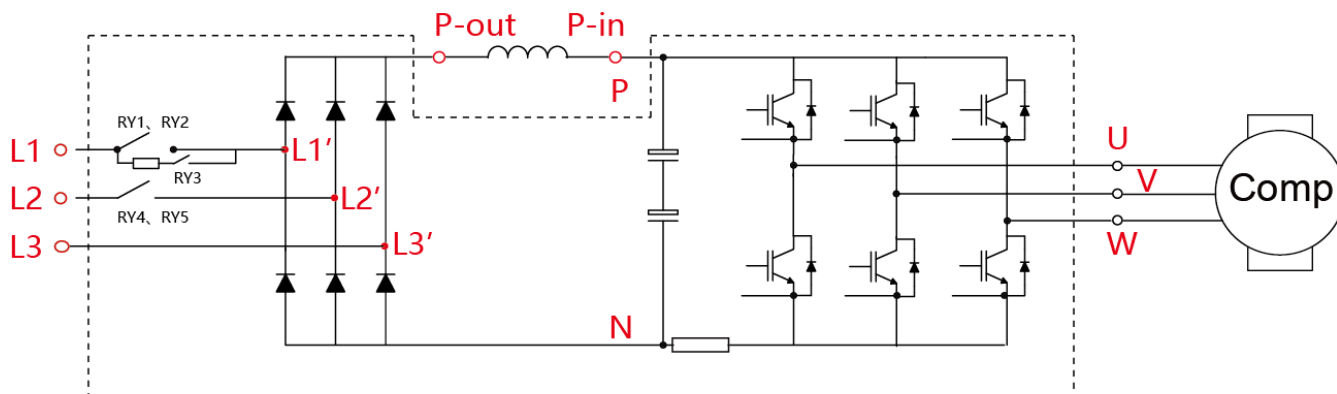
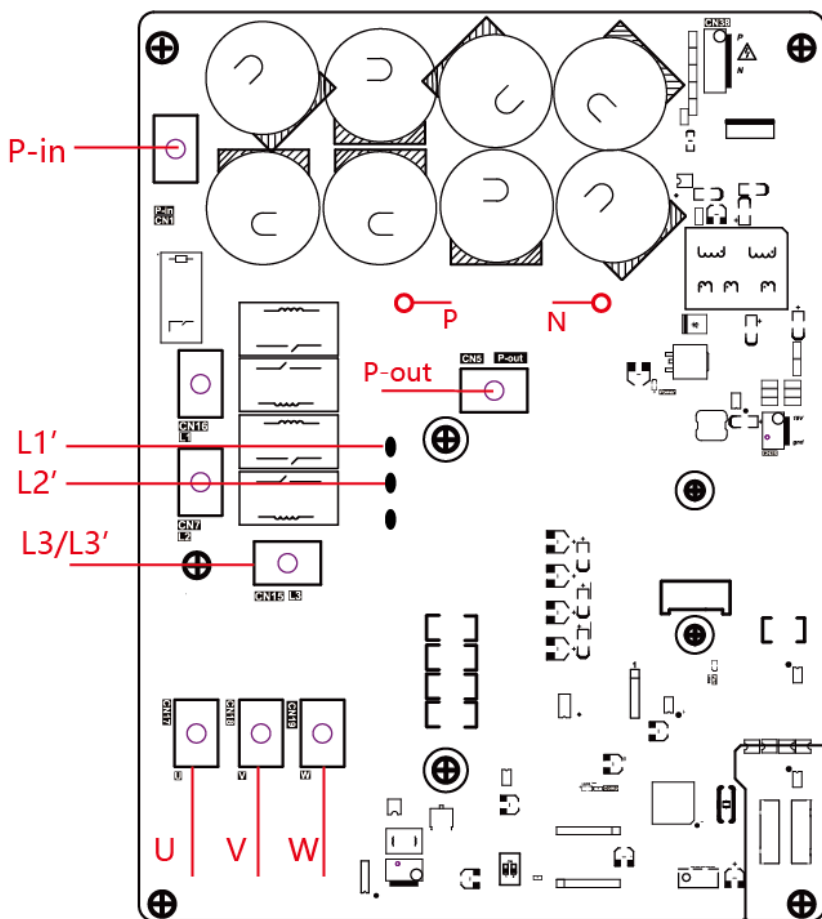

5.6 Appendix of Pressure Sensor Detection

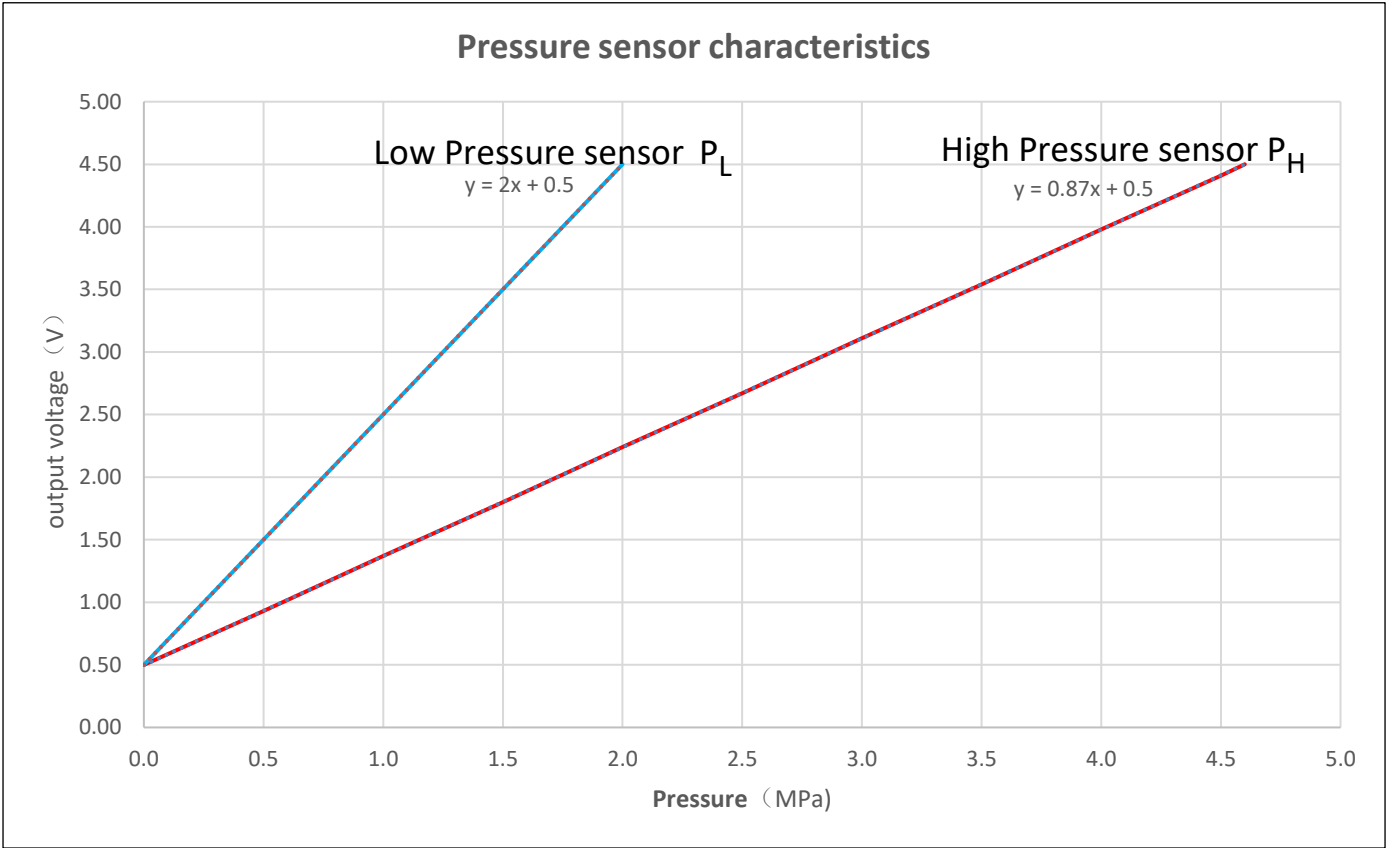

P_H : $V_{out}(H) = 0.87 \times P_H + 0.5$

P_L : $V_{out}(L) = 2 \times P_L + 0.5$

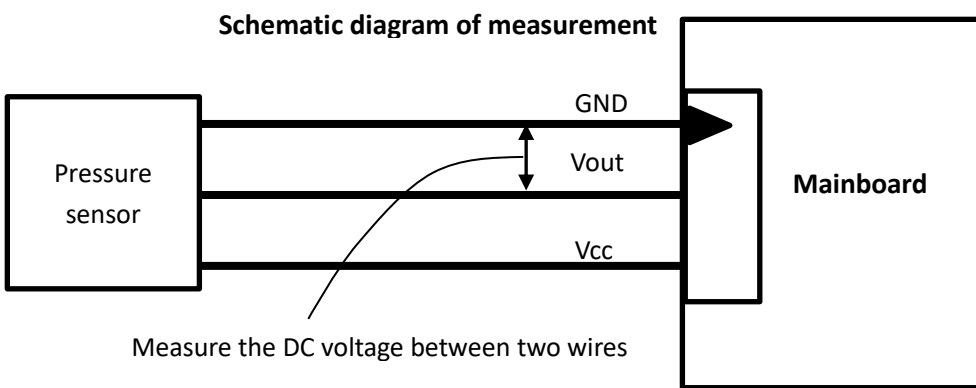

5.7 Refrigerant volume diagnosis

When running the refrigerant quantity detection program, the machine calculates the system refrigerant quantity according to the ambient temperature, condensing temperature and evaporation temperature, heat exchanger inlet and outlet temperature and other parameters, and give hints according to the results

The detection results of the system have V6 IDUs may have a large deviation. It is recommended to perform the refrigerant quantity diagnostic test when the system is all V8 IDUs and the communication protocol is V8 communication.

The following operating ranges must be met

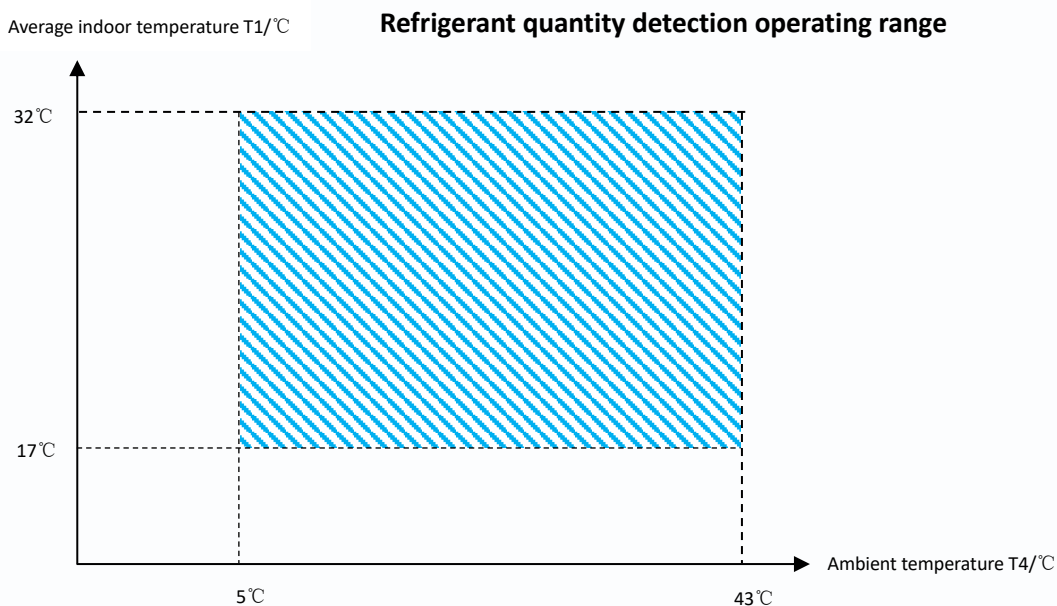

5.7.1 Procedure

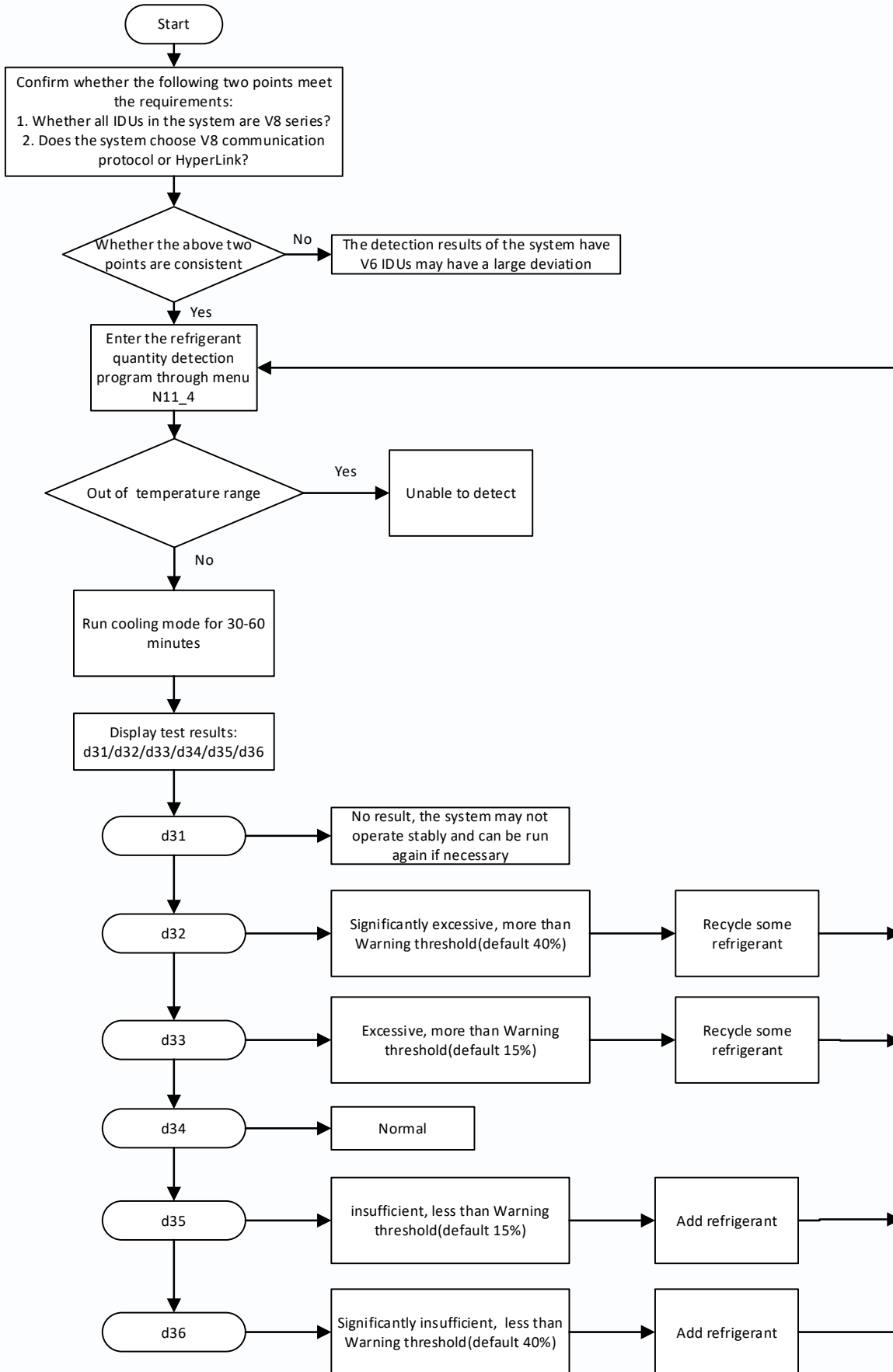

5.8 Oil volume table

Table 6-5.6: EasyFit Oil volume table:

HP	Oil model	Compressor A (Y1)	additional adding oil Volume	TOTAL OIL	TOTAL OIL
8HP	FV68H	1.1L	4L	4L+1.1L	5.1L
10HP	FV68H	1.1L	4L	4L+1.1L	5.1L
12HP	FV68H	1.1L	4L	4L+1.1L	5.1L
14HP	FV68H	1.1L	4L	4L+1.1L	5.1L
16HP	FV68H	1.1L	4.5L	4.5L+1.1L	5.6L
18HP	FV68H	1.1L	4.5L	4.5L+1.1L	5.6L
20HP	FV68H	1.1L	5.5L	5.5L+1.1L	6.6L
22HP	FV68H	1.1L	5.5L	5.5L+1.1L	6.6L

1. If we only need to replace the compressor, do not need to replace the Gas-liquid separator and the pipe, then how much oil you pulled out (for example you pulled out X), then you need to add X-Y1(for 14HP, Y1 is 1.1L)
2. If we need to replace all the compressors and we need to replace the Gas-liquid separator, then we need to add the additional adding oil Volume as above show.
- 3 Pls add the additional oil to the inlet of Gas-liquid separator, not directly to the compressor.

S-V8EasyFit 8-22HP EU

Ver. 2023-1

Midea Building Technologies Division
Midea Group

Add.: Midea Headquarters Building, 6 Midea Avenue, Shunde, Foshan, Guangdong, China

Postal code: 528311

mbt.midea.com / global.midea.com

Midea reserves the right to change the specifications of the product, and to withdraw or replace products without prior notification or public announcement. Midea is constantly developing and improving its products.

