

READ MY TIPS.



INSTALLING

# CARPET TILES

## INDEX

01 BEFORE YOU START 4

02 HOW TO PREPARE THE SUBFLOOR 6

03 HOW TO INSTALL THE CARPET TILES 11

04 HOW TO PROTECT YOUR FLOOR AFTER INSTALLATION 16

05 WARRANTY 17

### TOOLS

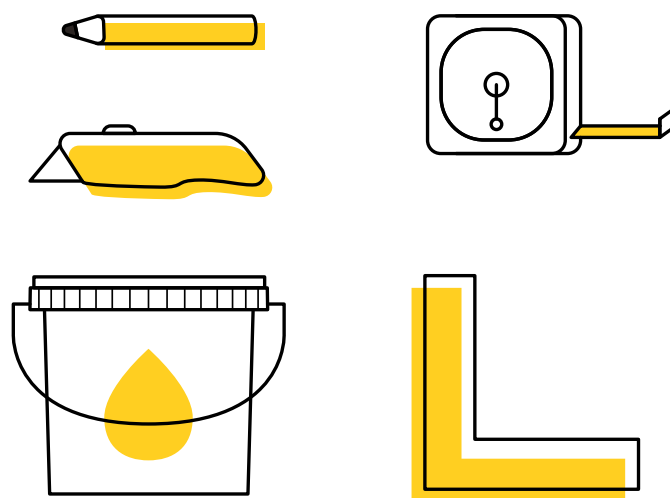

### PERSONAL PROTECTIVE EQUIPMENT

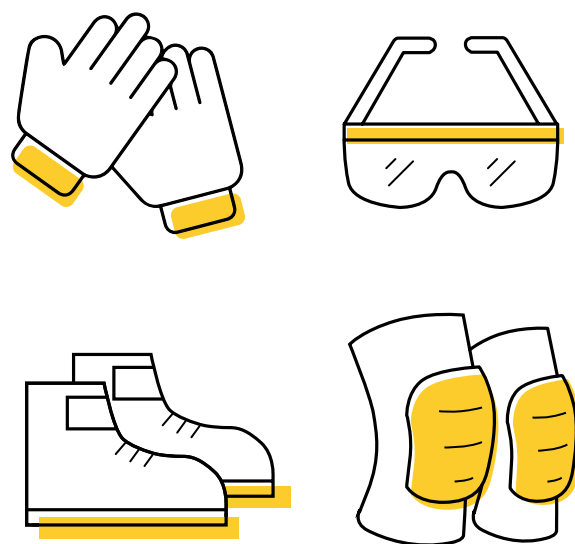

# MODULYSS CARPET TILES

modulyss carpet tiles are available in different colours, structures and patterns. As a result, the creative possibilities are endless. For optimal results, a correct installation is essential, so please follow these instructions carefully.

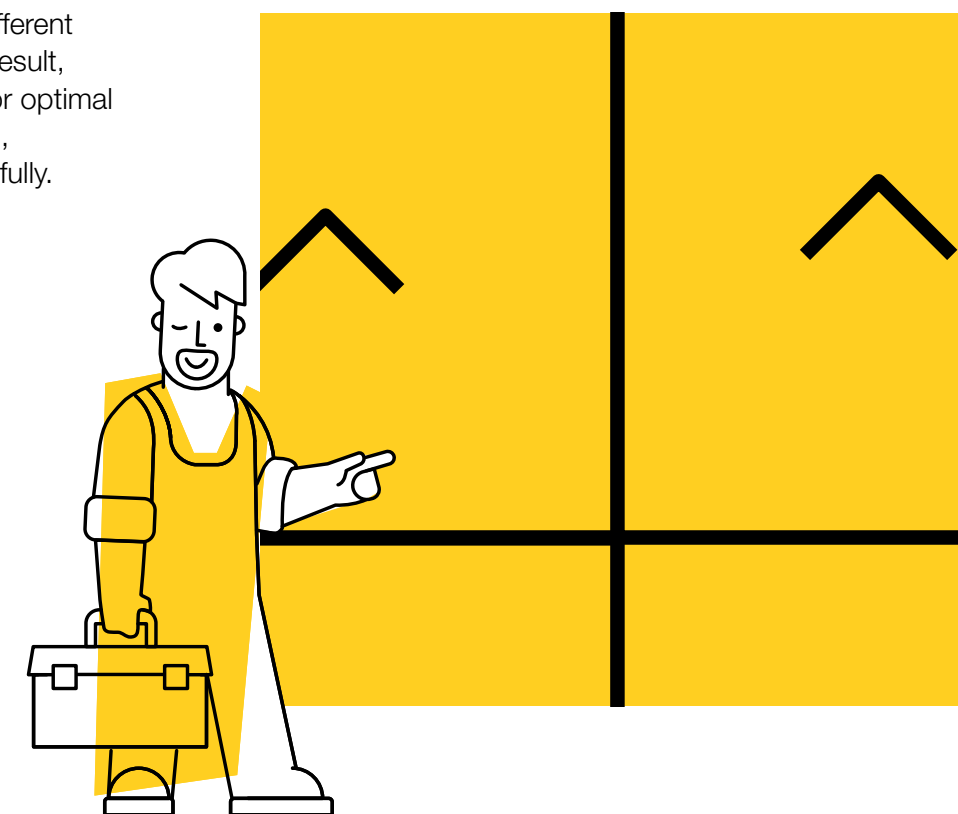

# 01 BEFORE YOU START

## Storing the tiles

If you are not installing the tiles immediately, store them in a closed room where the temperature is between 18°C and 28°C.

A pallet contains approximately 20 boxes. Do not stack more than 2 pallets or 10 boxes on top of each other, this is to avoid pile crushing. The boxes must be stored neatly at all times.

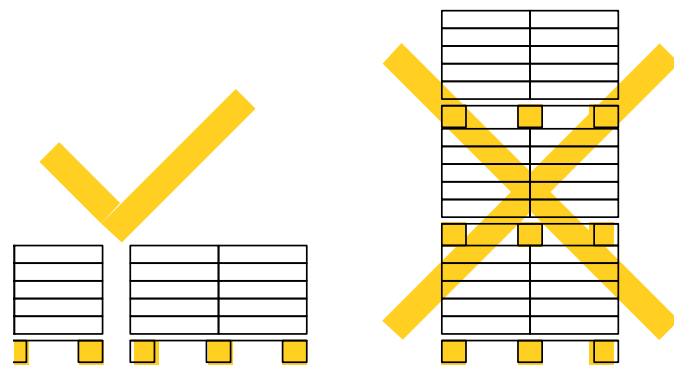

## Acclimatisation & site conditions

Prior to installation, all boxes should be placed on a flat surface in the room where the installation will take place. Remove the packaging, then open the boxes at the top or side and let the tiles acclimatise for at least 24 hours. The room temperature should be between 18°C and 28°C. The relative humidity should be between 30% and 65%.

18°C = 64°F  
28°C = 82°F

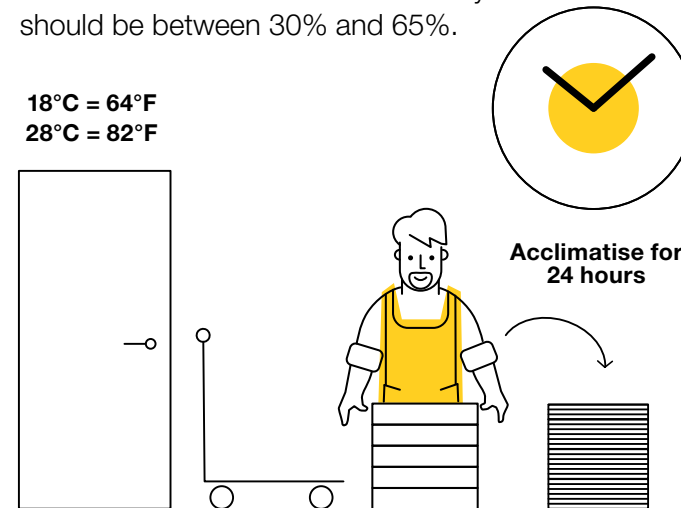

## Inspection

The product name, colour number and dye lot number are mentioned on each box.



1. Collection
2. Quality code
3. Colour number
4. Article number
5. Dye lot

This information, together with the arrow that indicates the pile direction, can also be found on the back of each carpet tile.

To guarantee an even result, it is very important to use tiles from the same dye lot in the same room. Therefore, always check the supplied material before starting the installation.

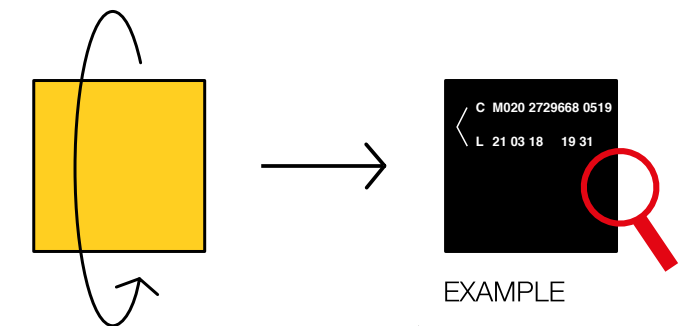

**EXAMPLE**

< Installation direction

**C** Tile C (can also be A,B or D)

**M020** Quality code

**2729668** Dye lot

**0519** Roll number

**L** Left roll (or R, Right roll)

**21 03 18** Production date

**19 31** Production time

# 02

## HOW TO PREPARE THE SUBFLOOR



For an easy and successful installation, all conditions as described in this section have to be carried out properly. Any deviation could result in an undesired end result and invalidate the warranty. We highly recommend postponing the installation of the tiles until all other works in the space are finished. This is to avoid damage and contamination.

For the dimensional stability of the carpet tiles (according to EN1307), it is important that a sufficiently stable subfloor with a linear expansion coefficient of no more than 0.05 mm/m/°C is used. The building regulations regarding the use of expansion joints must be strictly applied.

### Step 1: identify the substrate type

Start with the identification of the subfloor type and its condition.

modulyss carpet tiles can be installed on any subfloor that is dry, clean, grease-free, firm, stable and flat. Traces from previous floor coverings or adhesive residues must be removed. These general conditions must be respected regardless of the subfloor type.

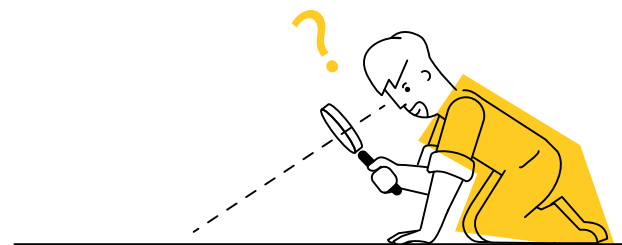

### Cement-based

A concrete subfloor must be level, clean and dry. If the surface is granular or porous, a primer should be applied. This primer must be compatible with the chosen adhesive. Please follow the adhesive manufacturer's instructions.

### Wood

Installing your carpet tiles on a wooden subfloor such as plywood, chipboard, MDF or hard-board is possible. However, you must always keep an eye on the indoor climate because there is a risk of deformation from moisture or overload. A load of 75 kg distributed over 20 cm should not result in deformation of the floor surface. Uneven floorboards must be carefully sanded and levelled to avoid any risk of imprints being seen through the tiles. Wood block floors should be smooth, sound and securely bonded.

If the wooden subfloor is in poor condition and very uneven, we recommend replacing it.

### Absorbent subfloor

If the subfloor is highly absorbent, a primer must be applied. Brushing the substrate with a wet brush will help determine the degree of absorption: the faster the water disappears, the higher the substrate's absorbency. To know which type of primer you should use can be determined by testing how quickly the water disappears. Please follow the primer manufacturer's instructions.

### Raised flooring systems

If the carpet tiles are being installed on raised access floor systems, the subfloor needs to be stable and even. Height differences between the panels may not exceed 1 mm. When installing the carpet tiles, please ensure that the seams of the carpet tiles are offset with the seams of the raised floor.

### Carpet

A carpet (underlay) cannot be used as a subfloor because it does not have the right properties.

When you are dealing with a different type of subfloor that is not mentioned above or if in doubt, modulyss can always offer advice and technical support.

## Step 2: check the conditions

The subfloor must be stable and dry in accordance with the requirements of national building standards and regulations. Before the installation can start, the following conditions must be respected: the ambient temperature should be between 18°C and 28°C and the subfloor should have a minimum temperature of 18°C. The relative humidity should be between 30% and 65%. These conditions must be respected 48 hours before installation, during installation and 72 hours after completion.

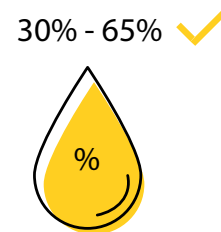
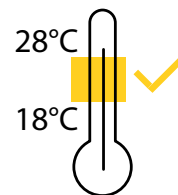

## Step 3: level the subfloor

Any cracks, tears or irregularities in the subfloor must be patched and levelled and allowed to dry to ensure the subfloor is flat and smooth.

Any unevenness of the subfloor must not be larger than 3 mm measured over a length of 2 m. Measured over a length of 0.2 m, the maximum permissible deviation is 1 mm. The permitted deviation is even lower for minituft carpet tiles.

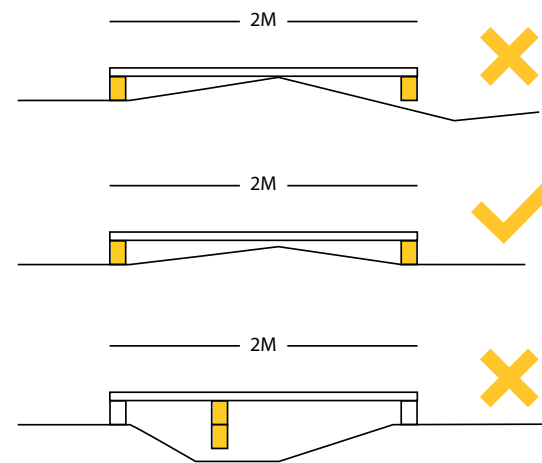

1. Fixed block with a thickness equal to the permissible deviation
2. Batten with a length of 2 m
3. Separate block twice as thick as the fixed blocks

## Subfloor for minituft carpet tiles

modulyss has several minituft carpet tile collections: Opposite, Grind and Blaze. With their low profile structure, minituft carpet tiles provide a clean minimalist look. However, due to this structure, more attention to detail is required during installation to achieve a perfect finish.

A solid subfloor is of the utmost importance for these collections. Minituft carpet tiles do not have a pile, which means any unevenness is immediately visible when the tiles are installed.

As a result, the unevenness of the subfloor for minituft carpet tiles must not be larger than 1.5 mm measured over a length of 2 m. Measured over a length of 0.2 m, the maximum permissible deviation is 0.5 mm.

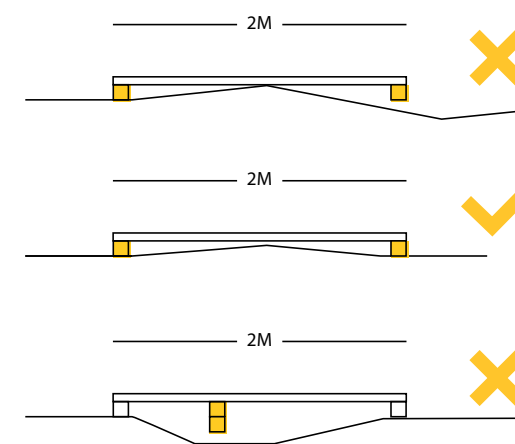

1. Fixed block with a thickness equal to the permissible deviation
2. Batten with a length of 2 m
3. Separate block twice as thick as the fixed blocks

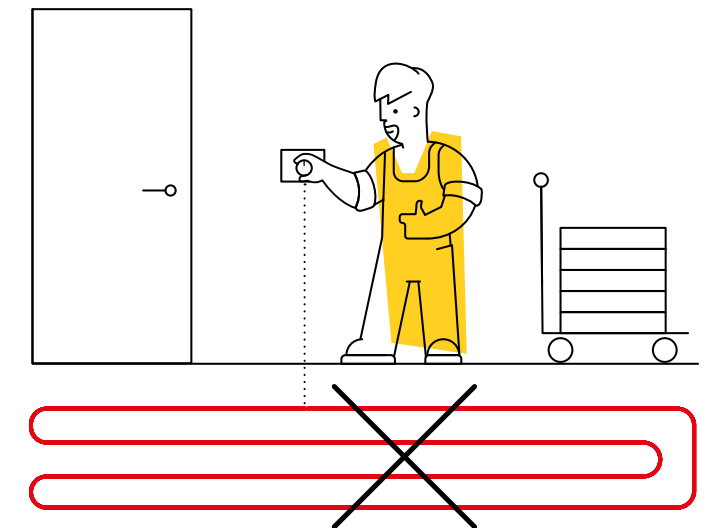

## Step 4: underfloor heating

In a room with underfloor heating, the underfloor heating system must be switched off at least 24 hours before the carpet is installed. Moreover, the underfloor heating system should be operational for at least 10 days prior the installation of the carpet tiles to ensure that all residual moisture has been evaporated.

48 hours after the installation of the carpet tiles, the underfloor heating system can be gradually brought back up to temperature by increments of 5°C per day, until it reaches standard operating temperature conditions, with a maximum of 27°C on the back of the carpet tiles. Make sure the heating circuit is fully waterproof.

### Step 5: check moisture content

At the moment there is no adhesive capable of gluing a textile floor covering to a (permanently) damp subfloor. Before installing modulyss carpet tiles, the substrate must be permanently dry.

The relative humidity of the ambient air should be between 30% and 65%.

It is generally recommended that the equilibrium moisture content of the wood be limited to 8% to 12%.

For screeds and concrete floors, the permissible moisture content differs, depending on the type of screed. This table indicates the limit values of the permissible moisture content:

Type backing	Subfloor type	Allowed moisture content (*)	Relative humidity (**)
Water damp permeable	Cement-based	3 CM-%	75%
	Anhydrite-based	1 CM-%	75%

### Step 6: Installation of carpet tiles in a new building

It is characteristic of new buildings that they are still settling and this can result in shrinkage and extension. And this is most pronounced in the first 6 months. We recommend postponing the installation of the carpet tiles for at least 6 months. If this is not possible, we recommend the following guidelines for installation:

1. Provide an expansion joint along the walls.

2. Take over the expansion joints of the underlying subfloor.

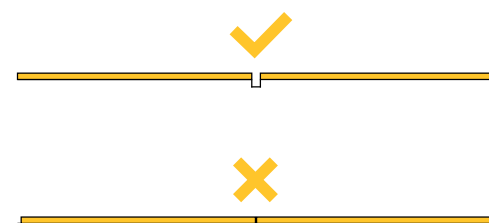

\* based on the Carbide method  
 \*\* surface relative humidity

1.

# 03 HOW TO INSTALL THE CARPET TILES

### Securing the carpet tiles

modulyss carpet tiles have a weight of >3.5 kg/m<sup>2</sup> and therefore, in accordance with EN1307, do not require permanent gluing. We do recommend using anti-slip, semi-permanent tackifier or self-adhesive tabs. Never install modulyss carpet tiles on a wet adhesive.

#### Anti-slip adhesive or tackifier

These types of adhesives form a film on the subfloor after application and drying. They have a durable, non-hardening adhesive which makes the tiles easy to remove. Apply a thin layer to the subfloor and ensure it is evenly distributed over the entire floor. A modulyss representative can give a recommendation on the type of tackifier according to the type of backing. Always check the manufacturer's instructions.

#### Flex Fitters

These self-adhesive tabs are an ideal alternative to the traditional adhesives used for installing carpet tiles. With practically no VOCs (Volatile Organic Compounds), this flexible method offers a sustainable solution. Extra information about the compatible products and how to install carpet tiles using Flex Fitters can be found on our website.

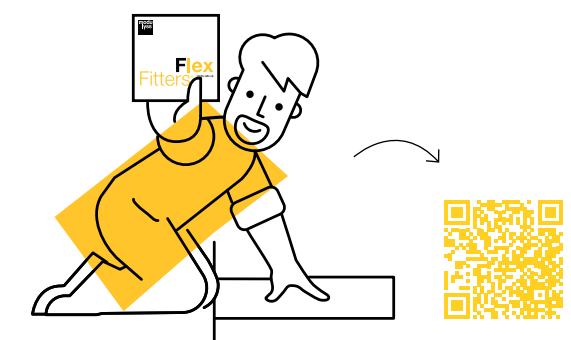

## Deciding where to start

Apply at least two perpendicular chalk lines to the substrate. These chalk lines must extend over the entire length and width. The intersection point of the chalk lines (highlighted below with a yellow dot) is best determined in advance so that the desired result can be obtained with as little cutting waste as possible.

Measure the room to find the best starting point for a maximum size perimeter tile. Proper planning should avoid cutting perimeter tiles more than half their width. Do not work with full tiles directly up to the wall because no wall is perfectly straight.

When the installation is complete, the tiles should fit together tightly but they should not be compressed. If the tiles do not fit nicely, open seams can occur. If they are compressed too tightly, bows or domes may appear in the tiles. An additional check can be performed during the installation by measuring the length of 10 tiles that have no visible openings, bumps or overlaps. The size must be equal to 10 times the size of the tile (+/- 0.2%). If this is the case, you have installed the carpet tiles correctly.

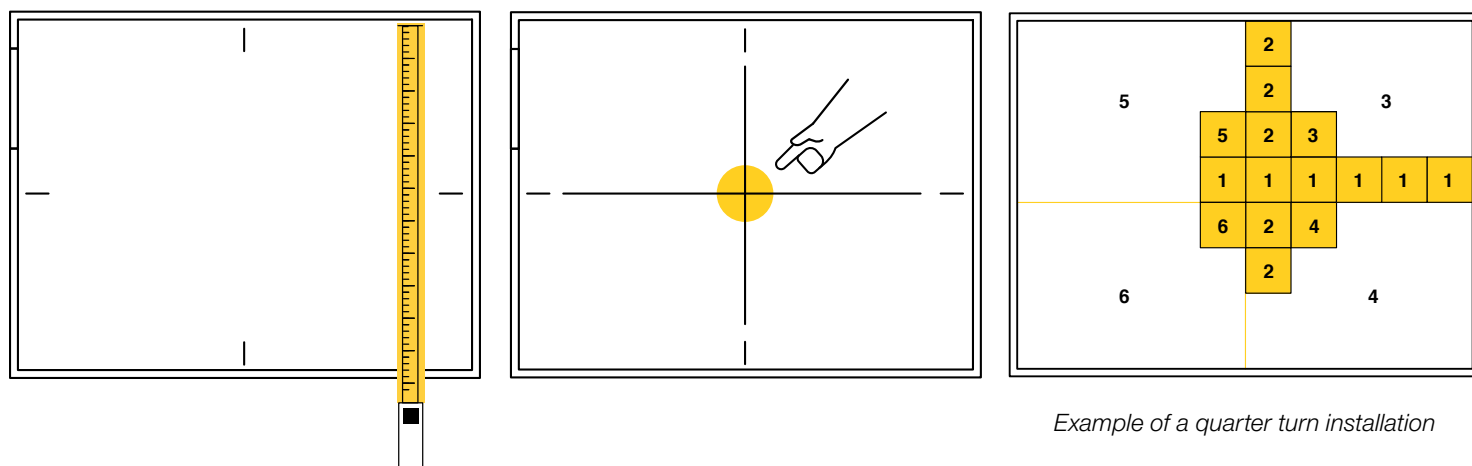

## Installing other tile structures and repeated patterns

### 1. Cut pile carpet tiles

As the name implies, carpet tiles with a cut pile have cut-through pile loops, providing a soft and luxurious look.

When installing these carpet tiles, ensure the pile does not get trapped between the seams of the tiles. When installing cut pile products, such as Cambridge and Gleam, please pay attention to this detail.

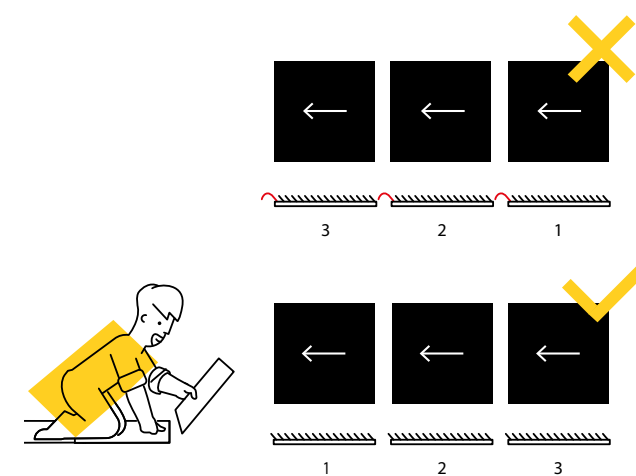

### 2. Tip-sheared carpet tiles

Tip-sheared carpet tiles, such as Fluid&, Velvet&, Txture, Alternative 100 and Mxture, are constructed as a loop pile with different heights. When the carpet is sheared, the higher loops are cut, but the lower ones are not. This creates an alternating pattern of loop and cut piles. The varying pile heights can create a visible seam effect during installation. This can be improved by interchanging tiles.

### 3. Minituft carpet tiles

Minituft carpet tiles require extra attention during installation. Due to the low-profile structure, open seams will be visible immediately. A tight fitting installation is an absolute must to minimise this.

A thorough check of the seams should be carried out and adjusted by replacing the tiles with another tile if required.

### 4. Pattern repeat

The construction, pattern repeat or cutting of the tiles can result in an undesired visual end result. This can be easily adjusted by replacing the tile with another tile. For example, when 2 tiles with a stripe along the edge are placed next to each other, you will see a thicker stripe. By replacing one of these tiles, you can avoid this visual effect.

## Choosing an installation method

There is an arrow indicating the pile direction on the back of the carpet tile. This is an aid for laying the product in different directions:

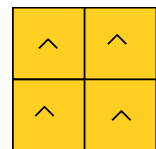

### Monolithic

The carpet tiles are laid in the same direction (arrows pointing in the same direction) to create a uniform floor covering.

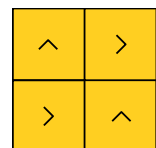

### Quarter turn

The arrow on the back of the carpet tile is alternately turned 90°.

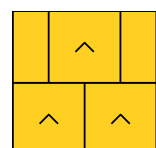

### Brick

All the arrows point in the same direction, but each tile is moved half a row horizontally so that the 4 corner points never coincide.

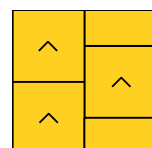

### Ashlar

All the arrows point in the same direction, but each tile is moved half a row vertically so that the 4 corner points never coincide.

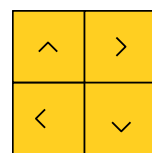

### Random

The tiles are placed randomly without any recurring pattern.

The technical datasheet (which you can find on [www.modulyss.com](http://www.modulyss.com)) shows which installation methods are recommended for the carpet tile collection in question. Please choose one of the recommended installation methods. If you would like to deviate from the described installation options, always consult modulyss first. A non-recommended installation method will invalidate the warranty.

Carpet tile seams will never be invisible, and are usually most visible immediately after installation. Seams become less and less visible with routine vacuuming and use.

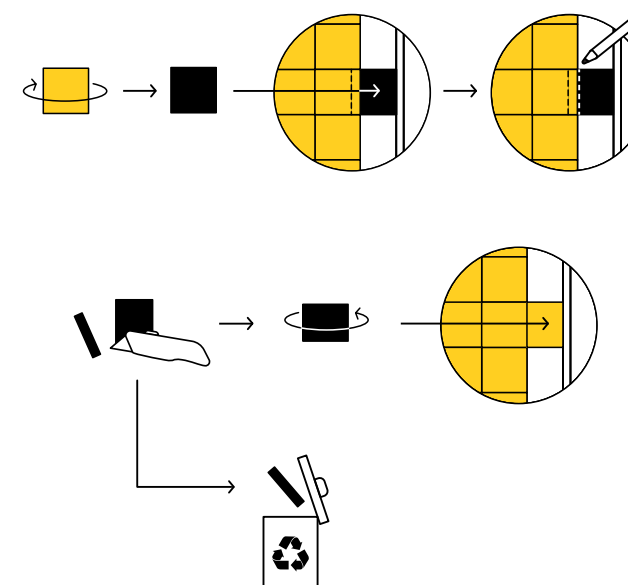

## Cutting the tiles

In most cases, to finish the room, carpet tiles will have to be cut to fit by means of a suitable floor cutting knife. The carpet tiles must be cut from the back. The cutting residue can be reused in the same room, but always place the uncut side against the adjacent tile.



# 04

## HOW TO PROTECT YOUR FLOOR AFTER INSTALLATION

Please ensure that the installed floor covering is protected sufficiently if other workers are expected to enter the area.

Place heavy equipment on hardboard plates so the carpet does not get damaged.

Ensure that no temperature peaks occur during the 7 days following installation.

During the entire life of the carpet tiles, the limit values of 18°C and 28°C, and the relative humidity between 30% and 65%, should be retained.



# 05

## WARRANTY

### Trial installation

Prior to each installation, up to 100 m<sup>2</sup> can be installed for assessment purposes. If a party has complaints about a deviation from the original specification, and/or a manufacturing defect is discovered, modulyss must be notified before further installation of the carpet tiles.

### 15-year warranty

For the best results, the carpet tiles must be installed properly and cleaned regularly to ensure the 15-year warranty remains valid. The carpet tiles must be installed according to the modulyss installation instructions, and cleaned and maintained according to the modulyss carpet tile cleaning recommendations (\*).

If a claim is made against the warranty, a check will be carried out to ensure the carpet tiles have been installed and cleaned in accordance with our instructions. modulyss cannot be held responsible for errors resulting from improper installation and/or cleaning and maintenance. Moreover, this will result in the loss of the 15-year warranty.

(\*). The latest version of the cleaning recommendations can be downloaded from the modulyss website.

modulyss  
Zevensterrestraat 21  
B 9240 Zele

T +32 (0)52 80 80 80  
F +32 (0)52 80 82 00  
info@modulyss.com

[www.modulyss.com](http://www.modulyss.com)



[www.modulyss.com](http://www.modulyss.com)