



TruVision Series 6 IP Camera Installation Guide

P/N 1073465-EN • REV E • ISS 03AUG21

Copyright © 2021 Carrier. All rights reserved. Specifications subject to change without prior notice.

This document may not be copied in whole or in part or otherwise reproduced without prior written consent from Carrier, except where specifically permitted under US and international copyright law.

Trademarks and patents TruVision names and logos are a product brand of Aritech, a part of Carrier.

Other trade names used in this document may be trademarks or registered trademarks of the manufacturers or vendors of the respective products.

Manufacturer PLACED ON THE MARKET BY:
Carrier Fire & Security Americas Corporation Inc.
13995 Pasteur Blvd, Palm Beach Gardens, FL
33418, USA

AUTHORIZED EU REPRESENTATIVE:
Carrier Fire & Security B.V.
Kelvinstraat 7, 6003 DH Weert, Netherlands

Certification



FCC compliance **Class A:** This equipment has been tested and found to comply with the limits for a Class A digital device, pursuant to part 15 of the FCC Rules. These limits are designed to provide reasonable protection against harmful interference when the equipment is operated in a commercial environment. This equipment generates, uses, and can radiate radio frequency energy and, if not installed and used in accordance with the instruction manual, may cause harmful interference to radio communications. Operation of this equipment in a residential area is likely to

cause harmful interference in which case the user will be required to correct the interference at his own expense.

FCC conditions

This device complies with Part 15 of the FCC Rules. Operation is subject to the following two conditions:

(1) This device may not cause harmful interference.

(2) This Device must accept any interference received, including interference that may cause undesired operation.

ACMA compliance

Notice! This is a Class A product. In a domestic environment this product may cause radio interference in which case the user may be required to take adequate measures.

Canada

This Class A digital apparatus complies with CAN ICES-003 (A)/NMB-3 (A).

Cet appareil numérique de la classe A est conforme à la norme CAN ICES-003 (A)/NMB-3 (A).

European Union directives

This product and - if applicable - the supplied accessories too are marked with "CE" and comply therefore with the applicable harmonized European standards listed under the EMC Directive 2014/30/EU, the RoHS Directive 2011/65/EU.



2012/19/EU (WEEE directive): Products marked with this symbol cannot be disposed of as unsorted municipal waste in the European Union. For proper recycling, return this product to your local supplier upon the purchase of equivalent new equipment, or dispose of it at designated collection points. For more information see: www.recyclethis.info.



2013/56/EU & 2006/66/EC (battery directive):

This product contains a battery that cannot be disposed of as unsorted municipal waste in the European Union. See the product documentation for specific battery information. The battery is marked with this symbol, which may include lettering to indicate cadmium (Cd), lead (Pb), or mercury (Hg). For proper recycling, return the battery to your supplier or to a designated collection point. For more information see: www.recyclethis.info.

Product warnings and disclaimers

THESE PRODUCTS ARE INTENDED FOR SALE TO AND INSTALLATION BY QUALIFIED PROFESSIONALS. CARRIER FIRE & SECURITY CANNOT PROVIDE ANY ASSURANCE THAT ANY PERSON OR ENTITY BUYING ITS PRODUCTS, INCLUDING ANY "AUTHORIZED DEALER" OR "AUTHORIZED RESELLER", IS PROPERLY TRAINED OR EXPERIENCED TO CORRECTLY INSTALL FIRE AND SECURITY RELATED PRODUCTS.

For more information on warranty disclaimers and product safety information, please check <https://firesecurityproducts.com/policy/product-warning/> or scan the QR code:



Contact information

EMEA: <https://firesecurityproducts.com>

Australian/New Zealand:

<https://firesecurityproducts.com.au/>

**Product
documentation**

Please consult the following web link to retrieve the electronic version of the product documentation. The manuals are available in several languages.



Safety instructions

These instructions are intended to ensure that user can use the product correctly to avoid danger or property loss.

The precaution measures are divided into “Warnings” and “Cautions”.



Warnings: Warning messages advise you of hazards that could result in injury or loss of life. They tell you which actions to take or to avoid in order to prevent the injury or loss of life.



Cautions: Caution messages advise you of possible equipment damage. They tell you which actions to take or to avoid in order to prevent damage.



Warnings

- When using this product, you must comply with the electrical safety regulations of the country and region. Please refer to the technical specifications for detailed information.
- Input voltage should meet both the SELV (Safety Extra Low Voltage) and the Limited Power Source with 24 VAC or 12 VDC according to the IEC60950-1 standard. Please refer to the technical specifications for detailed information.
- Do not connect several devices to one power adapter as adapter overload may cause over-heating or a fire hazard.

- Please make sure that the plug is firmly connected to the power socket. When the device is mounted on a wall or ceiling, it should be firmly fixed to the surface.
- If smoke, odor or noise rises from the device, turn off the power at once and unplug the power cable. Then please contact the service center.
- Proper configuration of all passwords and other security settings is the responsibility of the installer and/or end-user.



Cautions

- Make sure the power supply voltage is correct before using the camera.
- Do not drop the camera or subject it to physical shock.
- Do not touch sensor modules with fingers. If cleaning is necessary, use clean cloth with a bit of ethanol and wipe it gently. If the camera will not be used for an extended period, please replace the lens cap to protect the sensor from dirt.
- Do not aim the camera at the sun or extra bright places. Blooming or smearing may occur otherwise (which is not a malfunction), and affect the endurance of sensor at the same time.
- The sensor may be burned out by a laser beam, so when any laser equipment is in using, make sure that the surface of sensor will not be exposed to the laser beam.
- Do not place the camera in extremely hot, cold (the operating temperature is $-30^{\circ}\text{C} \sim +60^{\circ}\text{C}$, or $-40^{\circ}\text{C} \sim +60^{\circ}\text{C}$ if the camera model has an "H" in its suffix), dusty or damp locations, and do not expose it to high electromagnetic radiation.

- To avoid heat accumulation, good ventilation is required for operating environment.
- Keep the camera away from liquid while in use.
- During delivery, the camera shall be packed in its original packing, or packing of the same texture.
- Regular part replacement: a few parts (e.g. electrolytic capacitor) of the equipment shall be replaced regularly according to their average enduring time. The average time varies because of differences between operating environment and using history, so regular checking is recommended for all the users. Please contact with your dealer for more details.
- Improper use or replacement of the battery may result in hazard of explosion. Replace with the same or equivalent type only. Dispose of used batteries according to the instructions provided by the battery manufacturer.
- If the product does not work properly, please contact your dealer or the nearest service center. Never attempt to disassemble the camera yourself. (We shall not assume any responsibility for problems caused by unauthorized repair or maintenance.)

Content

Introduction 3

Product overview 3

Contact information and manuals /tools /firmware 4

Installation 6

Installation environment 7

Package contents 8

Cable requirements 21

Camera description 22

Setting up the camera 30

IR illuminators 31

Accessing the Micro SD card 31

Mounting the bullet camera 32

Mounting the turret camera 38

Mounting the dome camera 45

Mounting the wedge camera 55

Using the protective water resistant connector cover 59

Network access 63

Checking your web browser security level 63

Activating the camera 65

Using the camera with a TruVision recorder or another system 68

Using the camera with TruVision Navigator 68

Specifications 69

TruVision IP fixed lens bullet cameras 69

TruVision IP motorized lens bullet cameras 69

TruVision IP fixed lens turret dome	70
TruVision IP motorized lens turret dome	71
TruVision IP fixed lens dome cameras	71
TruVision IP motorized lens dome cameras	72
TruVision IP fixed lens wedge cameras	73
Pin definitions	74

Introduction

Product overview

This is the installation guide for TruVision Series 6 IP camera models:

- TVB-5601 (2MP IP fixed lens bullet camera)
- TVB-5602 (4MP IP fixed lens bullet camera)
- TVB-5603 (8M IP fixed lens bullet camera)

- TVB-5604 (2MP IP motorized lens bullet camera)
- TVB-5605 (4MP IP motorized lens bullet camera)
- TVB-5606 (8MP IP motorized lens bullet camera)

- TVT-5601 (2MP IP fixed lens turret camera, gray)
- TVT-5602 (2MP IP fixed lens turret camera, white)
- TVT-5603 (2MP IP fixed lens turret camera, black)
- TVT-5604 (4MP IP fixed lens turret camera, gray)
- TVT-5605 (4MP IP fixed lens turret camera, white)
- TVT-5606 (4MP IP fixed lens turret camera, black)
- TVT-5607 (8MP IP fixed lens turret camera, gray)

- TVT-5608 (2MP IP motorized lens turret camera, gray)
- TVT-5609 (4MP IP motorized lens turret camera, gray)
- TVT-5610 (4MP IP motorized lens turret camera, white)

- TVT-5611 (8MP IP motorized lens turret camera, gray)
- TVD-5601 (2MP IP fixed lens dome camera)
- TVD-5602 (4MP IP fixed lens dome camera)
- TVD-5603 (8MP IP fixed lens dome camera)
- TVD-5604 (2MP IP motorized lens dome camera)
- TVD-5605 (4MP IP motorized lens dome camera)
- TVD-5606 (8MP IP motorized lens dome camera)
- TVW-5601 (2MP IP fixed lens dome camera, 2.0 mm)
- TVW-5602 (2MP IP fixed lens dome camera, gray)
- TVW-5603 (2MP IP fixed lens dome camera, white)
- TVW-5604 (2MP IP fixed lens dome camera, black)
- TVW-5605 (4MP IP fixed lens dome camera, gray)

You can download the software and the following manuals from our web site:

- TruVision Series 6 IP Camera Installation Guide
- TruVision Series 6 IP Camera Configuration Manual

Contact information and manuals /tools /firmware

For contact information and to download the latest manuals, tools, and firmware, go to the web site of your region:

EMEA:

<https://firesecurityproducts.com>

Manuals are available in several languages.

Australia/New Zealand:

<https://firesecurityproducts.com.au/>

Installation

This section provides information on how to install the cameras.

Before you start:

- Make sure the device in the package is in good condition and all the assembly parts are included.
- The standard power supply is 12 VDC or PoE (802.3 af). Please make sure your power supply matches with your camera.
- Make sure all the related equipment is power-off during the installation.
- Check the specification of the products for the installation environment.
- Make sure that the wall is strong enough to withstand four times the weight of the camera and the bracket.

For the camera that supports IR, you are required to pay attention to the following precautions to prevent IR reflection:

- Dust or grease on the dome cover will cause IR reflection. Please do not remove the dome cover film until the installation is finished. If there is dust or grease on the dome cover, clean the dome cover with clean soft cloth and isopropyl alcohol.
- Make sure that there is no reflective surface too close to the camera lens. The IR light from the camera may reflect back into the lens causing reflection.
- The foam ring around the lens must be seated flush against the inner surface of the bubble to isolate the lens from the IR LEDs. Fasten the dome cover to camera body so that the foam ring and the dome cover are attached seamlessly.

Installation environment

When installing your product, consider these factors:

- **Electrical:** Install electrical wiring carefully. It should be done by qualified service personnel. Always use a proper PoE switch or a 12 VDC UL listed Class 2 or CE certified power supply to power the camera. Do not overload the power cord or adapter.
- **Ventilation:** Ensure that the location planned for the installation of the camera is well ventilated.
- **Temperature:** Do not operate the camera beyond the specified temperature, humidity or power source ratings. The operating temperature of the camera without heater is between -30 to +60°C (-22 to 140°F). Humidity is below 90%. For the outdoor cameras that feature built-in heaters, the operating temperature range is -40 to 60°C (-40 to 140°F)
- **Moisture:** Do not expose the camera to rain or moisture or try to operate it in wet areas. Turn the power off immediately if the camera is wet and ask a qualified service person for servicing. Moisture can damage the camera and also create the danger of electric shock.
- **Servicing:** Do not attempt to service this camera yourself. Any attempt to dismantle or remove the covers from this product will invalidate the warranty and may also result in serious injury. Refer all servicing to qualified service personnel.
- **Cleaning:** Do not touch the sensor modules with fingers. If cleaning is necessary, use a clean cloth with some ethanol and wipe the camera gently. If the camera will not be used for an extended period of time, put on the lens cap to protect the sensors from dirt.

Package contents

Check the package and contents for visible damage. If any components are damaged or missing, do not attempt to use the unit; contact the supplier immediately. If the unit is returned, it must be shipped back in its original packaging.

IP fixed lens bullet camera

- Camera

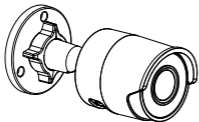

- 12 VDC connector:
Two terminal connector with positive and negative indicators.



- Protective water resistant RJ45 connector cover:
Provides water resistance to network cable connector.

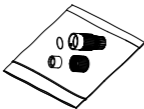

- Drill template

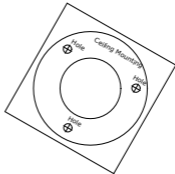

- Screws

Drywall anchor
7.5 × 24.5 mm (3 pcs)



Screw
M4 × 25 mm (3 pcs)



- Installation guide



- Torx wrench



- Equipment disposal sheet

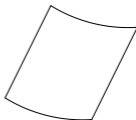

- Battery disposal sheet

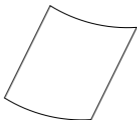

IP motorized lens bullet camera

- Camera

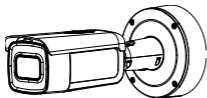

- Mounting adapter plate

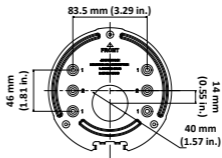

- Screws

Drywall anchor
7.5 × 24.5 mm (4 pcs)



Screw
M4 × 25 mm (4 pcs)



- Video test cable

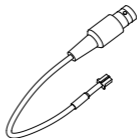

- Installation guide



- Equipment disposal sheet

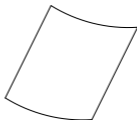

- Battery disposal sheet

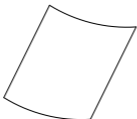

- Torx wrench



- Cable routing tool



- Adapter ring for G3/4

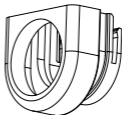

- Back box

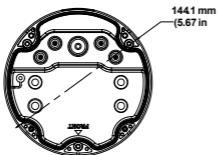

- Screws for the back box

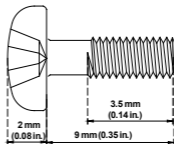

- G3/4 cable adapter

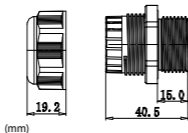

IP fixed lens turret camera

- Camera

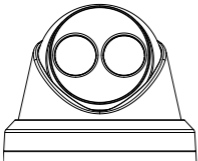

- 12 VDC connector:
Two terminal connector with positive and negative indicators.



- Camera drill template

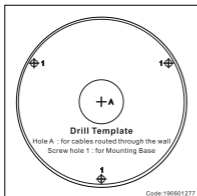

- Protective water resistant RJ45 connector cover:
Provides water resistance to network cable connector.



- Screws

Drywall anchor
7.5 × 24.5 mm (3 pcs)



Screw
M4 × 25 mm (3 pcs)



- Adapter plate

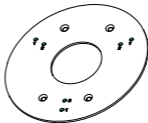

- Torx wrench



- Screw PM4 × 8
(3pcs)



- Screw PM6-32 × 10
(4 pcs, used to attach the turret camera to a 2 Gang electrical box)



- Screw KM4 × 8
(4 pcs, used to attach the adapter to the brackets)

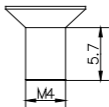

- Installation guide



- Installation guide of the turret adapter

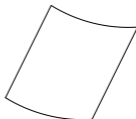

- Equipment disposal sheet

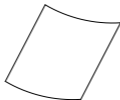

- Battery disposal sheet

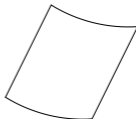

IP motorized lens turret camera

- Camera

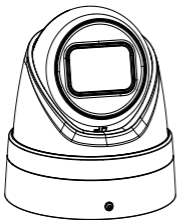

- Mounting adapter plate

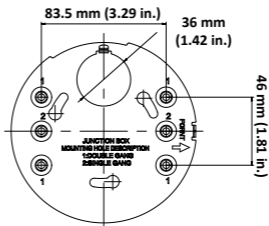

- Screws

Drywall anchor
7.5 × 24.5 mm (4 pcs)



Screw
M4 × 25 mm (4 pcs)



- Torx wrench

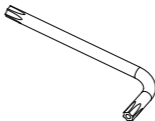

- Installation guide



- Battery disposal sheet

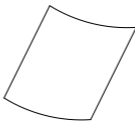

- Equipment disposal sheet

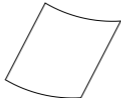

IP fixed lens dome camera

- Camera

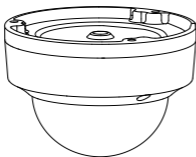

- 12 VDC connector:
Two terminal connector with positive and negative indicators.



- Camera drill template



- Screws

Drywall anchor
7.5 × 24.5 mm (3 pcs)



Screw
M4 × 25 mm (3 pcs)



- Torx wrench



- Water joint: Provides water resistance to network cable connector.



- Toggle bolt (3 pcs)



- Gray cloth



- Installation guide



- Equipment disposal sheet

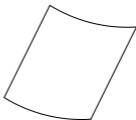

- Battery disposal sheet

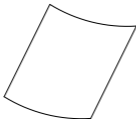

IP motorized lens dome camera

- Camera

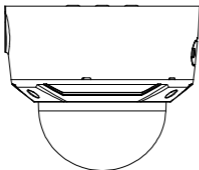

- Mounting adapter plate

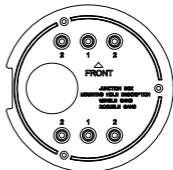

- Video test cable

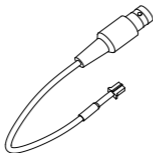

- Screws

Drywall anchor
7.5 × 24.5 mm (4 pcs)



Screw
M4 × 25 mm (4 pcs)



- Torx wrench



- Cable routing tool

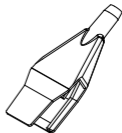

- Gray cloth



- G3/4 cable adapter

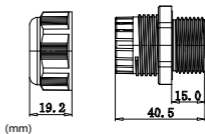

- Installation guide



- Equipment disposal sheet

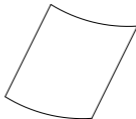

- Battery disposal sheet

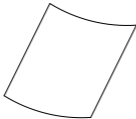

IP fixed lens wedge camera

- Camera

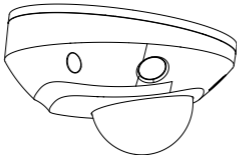

- 12 VDC connector:
Two terminal connector with positive and negative indicators.



- Screws
Drywall anchor
7.5 × 24.5 mm (3 pcs)



- Screw
M4 × 25 mm (3 pcs)



- Screws: M4 × 8 (3 pcs)
Used for mounting the wedge to the adapter plate



- Adapter plate



- Protective water resistant RJ45 connector cover:
Provides water resistance to network cable connector.



- Torx wrench



- Gray cloth



- Installation guide



- Equipment disposal sheet

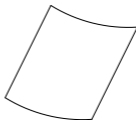

- Battery disposal sheet

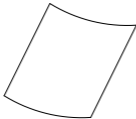

Caution: Use direct plug-in UL listed power supplies marked Class 2/CE certified or LPS (limited power source) of the required output rating as listed on the unit.

Caution: Risk of explosion if the battery is replaced by an incorrect type. Dispose of used batteries according to the instructions.

Cable requirements

For proper operation, adhere to the following cable and power requirements for the cameras. Category 5 cabling or better is recommended. All network cabling must be installed according to applicable codes and regulations. Table 1 lists the requirements for the cables that connect to the camera.

Table 1: Recommended power requirements

IP fixed lens bullet camera:	12 VDC or PoE (802.3af)
IP motorized lens bullet camera:	12 VDC or PoE+ (802.3at)
IP fixed lens turret camera:	12 VDC or PoE (802.3af)
IP motorized lens turret camera:	12 VDC or PoE (802.3af)
IP fixed lens dome camera:	12 VDC or PoE (802.3af)
IP motorized lens dome camera:	12 VDC or PoE (802.3af)
IP fixed lens wedge camera:	12 VDC or PoE (802.3af)

Camera description

Figure 1: IP fixed lens bullet camera

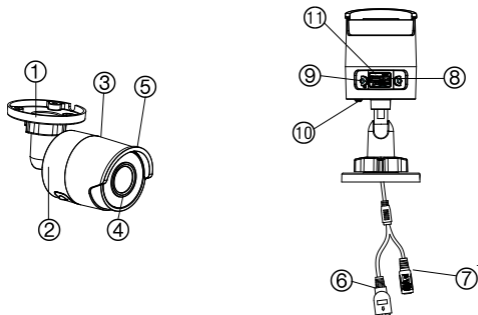

- | | |
|---------------------------|-------------------------------|
| 1. Adjustable bracket | 7. 12 VDC power |
| 2. Back housing | 8. Reset button |
| 3. Front housing | 9. Micro SD card slot |
| 4. Lens | 10. Grounding screw |
| 5. Sunshield | 11. Serial port (factory use) |
| 6. Ethernet RJ45 PoE port | |

Note: To reset the camera to default settings, press and hold the RESET button and power on the camera. After the camera has started up, hold the RESET button for an additional 20 seconds.

Figure 2: IP motorized lens bullet camera

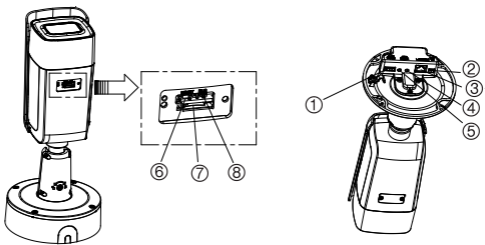

- | | |
|---|---------------------------------|
| 1. Alarm 1 input /1 output
(up to 12 VDC, 30 mA) | 5. Audio 1 output (line
out) |
| 2. 12 VDC power | 6. Reset button |
| 3. Ethernet RJ45 PoE
port | 7. Micro SD card slot |
| 4. Audio 1 input (line
in/mic in) | 8. 960H analog output |

Note: To reset the camera to default settings, press and hold the RESET button and power on the camera. After the camera has started up, hold the RESET button for an additional 20 seconds.

Figure 3: IP fixed lens turret camera

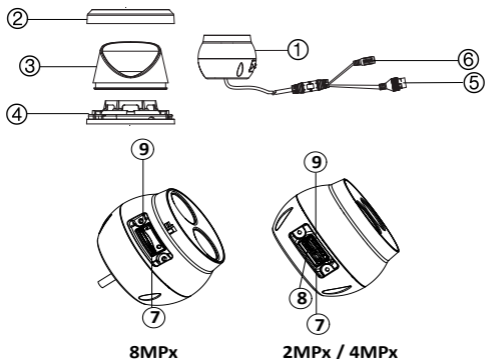

1. Lens assembly
2. Trim ring
3. Housing
4. Base
5. 12 VDC power

6. Ethernet RJ45 PoE port
7. Reset button
8. Serial port (factory use)
9. Micro SD card slot

Note: To reset the camera to default settings, press and hold the RESET button and power on the camera. After the camera has started up, hold the RESET button for an additional 20 seconds.

Figure 4: IP motorized turret camera

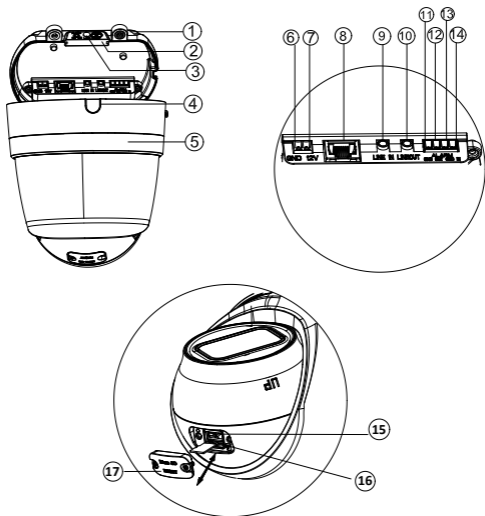

- | | |
|----------------------------------|--|
| 1. Housing | 9. Audio 1 input (line in/mic in) |
| 2. Black rubber protective cover | 10. Audio 1 output (line out) |
| 3. Rubber inserts | 11. GND for alarm output |
| 4. Removable cable access door | 12. Alarm 1 output (up to 12VDC, 30mA) |
| 5. Trim ring | 13. GND for alarm input |

- | | |
|-----------------------------------|------------------------|
| 6. GND for 12 VDC power | 14. Alarm 1 input |
| 7. Positive pole for 12 VDC power | 15. Reset button |
| 8. Ethernet RJ45 PoE port | 16. Micro SD card slot |
| | 17. SD card cover |

Note: To reset the camera to default settings, press and hold the RESET button and power on the camera. After the camera has started up, hold the RESET button for an additional 20 seconds.

Figure 5: IP fixed lens dome camera

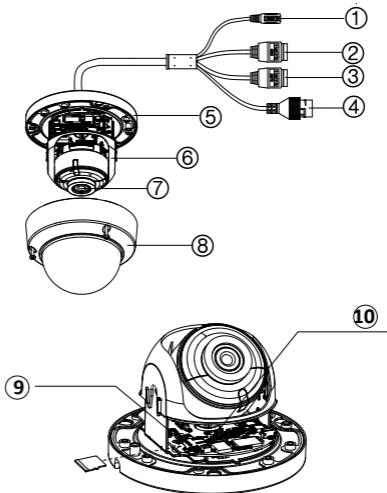

- | | |
|---|------------------|
| 1. 12 VDC power | 5. Base |
| 2. Audio 1 input (line in/mic in) / 1 output (line out) | 6. Dome liner |
| 3. Alarm 1 input/1 output (up to 12 VDC, 30 mA) | 7. Lens |
| 4. Ethernet RJ45 PoE port | 8. Housing cover |
| | 9. SD card slot |
| | 10. Reset button |

Note: To reset the camera to default settings, press and hold the RESET button and power on the camera. After the camera

has started up, hold the RESET button for an additional 20 seconds.

Figure 6: IP motorized lens dome camera

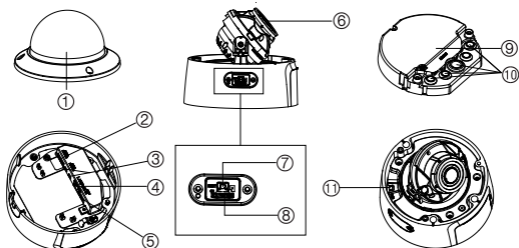

- | | |
|---|-----------------------|
| 1. Housing cover | 6. Lens assembly |
| 2. Audio 1 input (line in/mic in) / 1 output (line out) | 7. Reset button |
| 3. Alarm 1 input/1 output (up to 12 VDC, 30 mA) | 8. Micro SD card slot |
| 4. Ethernet RJ45 PoE port | 9. Back box |
| 5. 12 VDC power | 10. Rubber seal |
| | 11. 960H output |

Note: To reset the camera to default settings, press and hold the RESET button and power on the camera. After the camera has started up, hold the RESET button for an additional 20 seconds.

For a proper fit, the access panel to the SD card and Reset button needs to be installed with the thicker section of the panel towards the base of the dome.

note: To reset the camera to default settings, press and hold the RESET button and power on the camera. After the camera has started up, hold the RESET button for an additional 20 seconds.

For a proper fit, the access panel to the SD card and Reset button needs to be installed with the thicker section of the panel towards the base of the dome.

Figure 8: IP fixed lens wedge camera

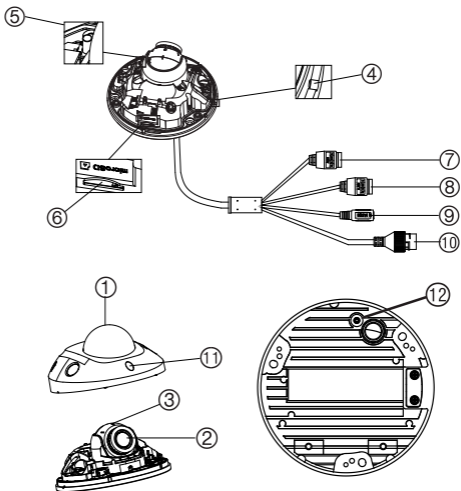

1. Housing cover

8. Alarm 1 input/1 output

- | | |
|--|----------------------------|
| 2. Lens assembly | 9. 12 VDC power |
| 3. Camera assembly | 10. Ethernet RJ45 PoE port |
| 4. MIC (microphone) | 11. IR illuminators |
| 5. Reset button | 12. Ground |
| 6. Micro SD card slot | |
| 7. Audio 2 inputs. Line in or MIC (built-in microphone) / 1 output | |

Note: To reset the camera to default settings, press and hold the RESET button and power on the camera. After the camera has started up, hold the RESET button for an additional 20 seconds.

Setting up the camera

Note: If the light source where the camera is installed experiences rapid, wide-variations in lighting, the camera may not operate as intended.

To quickly put the camera into operation:

1. Prepare the mounting surface.
2. Mount the camera on the mounting surface using the appropriate fasteners. See “Mounting the wedge camera” on page 55.
3. Set up the camera’s network and streaming parameters so that the camera can be controlled over the network. For further information, please refer to the “TruVision Series 6 IP Camera Configuration Manual”.
4. Program the camera as appropriate for its location. For further information, please refer to the “TruVision Series 6 IP Camera Configuration Manual”.

IR illuminators

The camera's built-in IR illumination provides high-quality video in low-light environments, even when there is no other illumination available.

You can configure the IR illumination using a web browser or a client software, such as TruVision Navigator. If the function is enabled, the IR light is On when the camera enters night (black and white) mode. If disabled, the IR light is always Off.

The visible IR range may vary due to multiple factors such as weather, IR reflection level of objects in frame, lens adjustment, and camera settings. Please refer to the camera datasheet for the standard IR range.

Note: Avoid installing the IR camera closely facing a solid object such as a tree or wall. The reflection will cause over-exposure and loss of visibility of detail in field of view.

Accessing the Micro SD card

Insert a Micro SD card with up to 128GB to use the camera as an additional recording device, or as a backup in case of failure of communication with the network video recorder (see Figure 1 on page 22). The card is not supplied with the camera.

Recorded video and log files can be accessed via the web browser or via TruVision Navigator.

Mounting the bullet camera

Mount the camera on a ceiling or wall.

To mount the IP fixed lens bullet camera:

1. Use the supplied template to mark out the mounting area. Drill the screw holes on the ceiling or wall. If you need to route the cables from the camera base, drill a cable hole in the ceiling or wall.
2. Secure the mounting base to the ceiling or wall using the three mounting screws and drywall anchors.

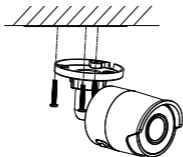

3. Loosen the large nut at the base of the mounting bracket to adjust the camera's viewing angle.
Pan direction: 0 to 360° adjustable
Tilt direction: 0 to 90° adjustable
Rotate direction: 0 to 360° adjustable
4. Adjust the lens to the desired surveillance angle. Tighten the adjustable nuts to complete the installation.

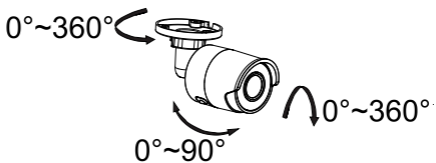

To mount the IP motorized lens bullet camera:

1. Drill screw holes in the wall/ceiling according to the holes 1 on the mounting adapter plate.

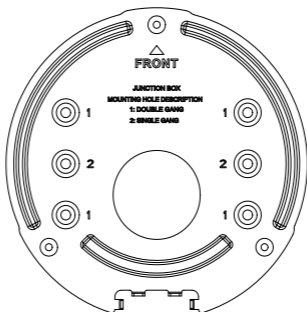

2. Secure the mounting adapter plate to the wall/ceiling with the screws.

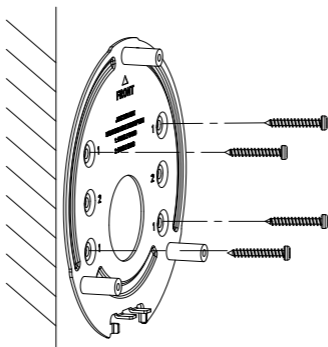

3. Loosen the screws to remove the back box.

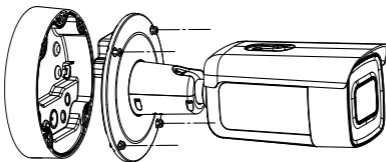

4. Route the cables through the sealing plugs in the back box.
 - a) Pierce the sealing plugs on the back box.
 - b) Thread cables through the sealing plugs.

Note:

- For RJ45 network interface, use the supplied cable routing tool.

- For the audio interface, first thread the audio cable through the sealing plug and then connect the audio connector to the cable.

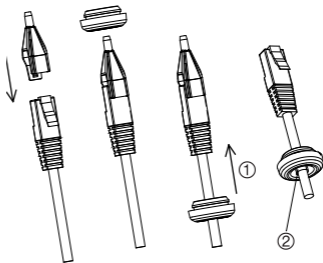

1. Drag the sealing plug back
2. Valgus

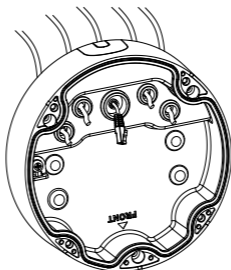

5. Secure the back box in the wall/ceiling with screws.

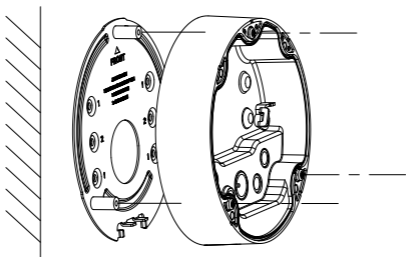

6. Hook the camera to the back box with the safety lanyard and connect the cables to the camera.

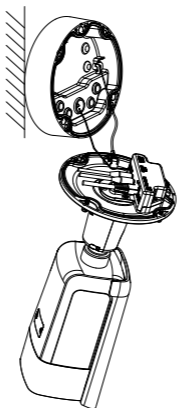

7. Secure the camera to the back box with the screws.

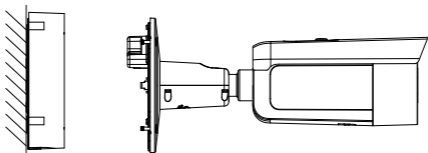

8. Adjust the viewing angle.

3-axis adjusting (pan/tilt/rotation) allows you to adjust for optimum camera rotation and placement. Follow the steps below to adjust the viewing angle.

- a) Loosen the lock screw using the supplied wrench.
- b) Adjust the view angle of the camera. The adjusting range of the panning is from 0° to 360° , the tilting is from 0° to 90° and the rotation is from 0° to 360° .
- c) Tighten the lock screw.

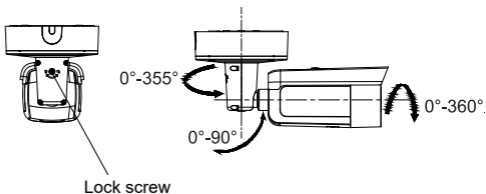

Mounting the turret camera

To mount the fixed lens turret camera on a surface:

1. Place the drill template (supplied) on the surface where the camera is to be mounted. Drill mounting holes in the surface using the holes labeled number "1" on the drill template.

To route the cable harness through the mounting surface, cut a cable access hole in the mounting surface, referencing the letter "A" on the drill template. Skip this step if you want to route the cables on the surface.

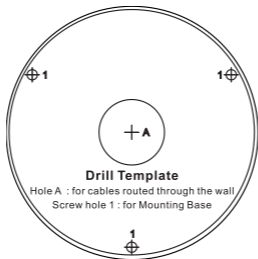

An adapter plate is provided if installing the turret camera to a wall mount or other accessory. Install the adapter plate to the accessory with three PM4X8 screws, referencing number "2".

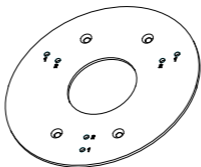

2. Rotate the trim ring counterclockwise to remove it from the camera.
3. Route the cables directly out of the base of the camera.
4. Install the camera on the mounting surface using the supplied hardware.
5. Connect the corresponding power and network cables.
6. Adjust the lens.
 - a) Loosen the locking screw using a Torx screw driver.
 - b) Rotate the lens assembly to adjust the pan angle.
Rotate the lens assembly to adjust the tilt angle.
 - c) Tighten the Torx screw to secure the lens at the desired surveillance angle.

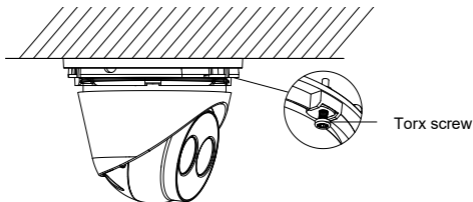

7. Attach the trim ring to the camera and rotate it clockwise to secure it.

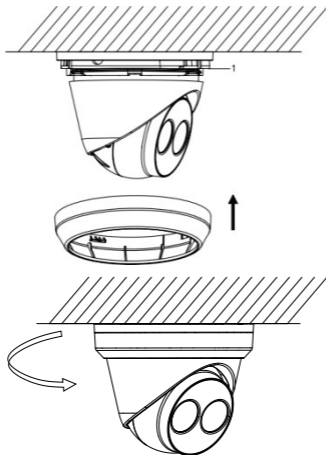

To mount the motorized lens turret camera on a ceiling or wall:

1. Using the turret adapter plate, mark the mounting holes for the plate. Use the four holes labeled with the number 1.

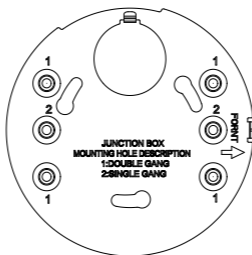

2. Secure the mounting adapter to the mounting surface with the supplied screws.

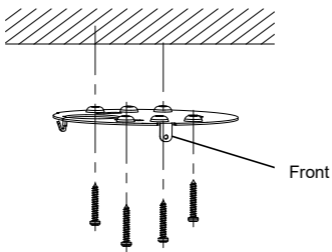

3. Hook the camera to the adapter with the safety lanyard.

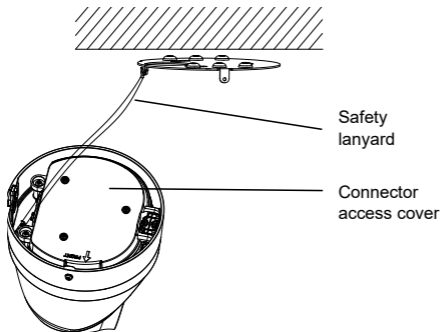

4. To access the connectors, loosen the two screws using the Torx wrench and lift up on the access cover. The black rubber insert at the edge of the access cover is required to maintain the IP67 rating. Only remove the plugs that cover the access ports required to provide access for the cables that will be connected to the camera.

A spare rubber insert is included with the camera for cases when a larger cable access hole is required.

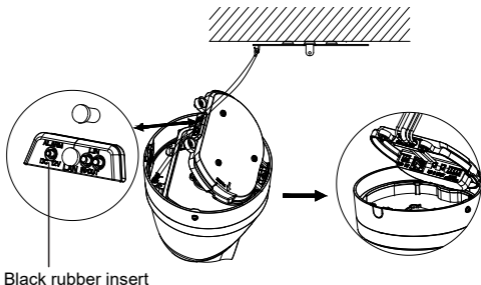

Note:

When routing the cables, remove the whole rubber sealing, then remove the sealing pillar, and then insert the wire. Otherwise, keep the sealing plug intact.

5. Once all the cable connections are made, lower the access cover and tighten the Torx screws. Line up the turret with the mounting plate, there is an arrow and the word FRONT referenced on the turret base and mounting plate. Line up the three Phillips screws that are located on the access cover with the three slots in the adapter plate. Rotate the turret clockwise as far as the turret will travel. Tighten the locking Torx screw at the base of the turret.

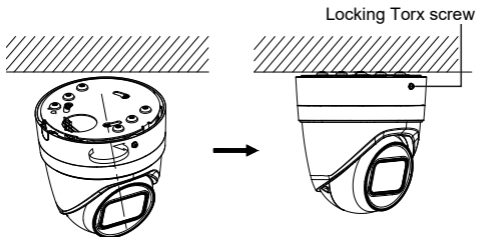

6. Adjust the lens position.

- a) To adjust the lens position, remove the decorative trim ring by rotating the ring towards the unlocked position (see reference on the trim ring). Loosen the lens adjustment Torx screw that is now visible.

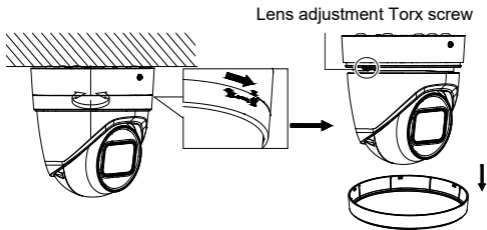

- b) Rotate the lens assembly to adjust the pan tilt angle.
- c) Tighten the lens adjustment screw to secure the lens at the desired surveillance angle.

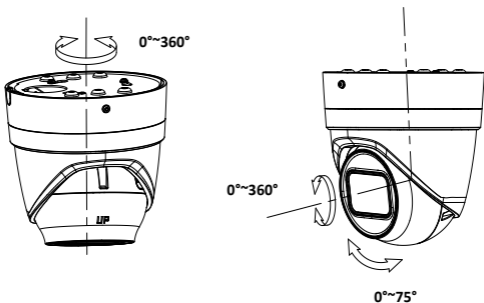

7. Reinstall the trim ring on the camera, and rotate it clockwise to secure.

To mount the motorized lens turret camera on a wall:

Please refer to the installation guide provided with the TVD-CB6 mounting kit for instructions on mounting the motorized lens turret camera to the wall.

Mounting the dome camera

To mount the fixed lens dome camera on a ceiling or wall using a wall mount:

1. Place the drill template (supplied) on the surface where the camera is to be mounted. Drill mounting holes in the surface using the holes labeled number "1" on the drill template.

To route the cable harness through the mounting surface, and cut a cable access hole in the mounting surface,

referencing the letter "A" on the drill template. Skip this step if you want to route the cables on the surface.



2. Using the supplied Torx wrench, remove the dome bubble assembly.

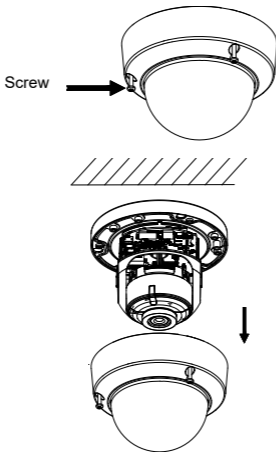

3. Install the dome on the mounting surface using the supplied hardware.

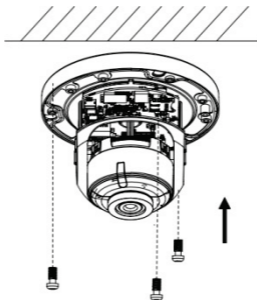

4. Loosen the tilt adjust screws (see image below) and adjust the tilt position of the lens assembly within a range of 75 degrees. Retighten the tilt adjust screws.

Rotate the dome liner to adjust the pan position within a range of 355 degrees. Rotate the lens assembly (0 to 355°) to obtain the desired surveillance angle.

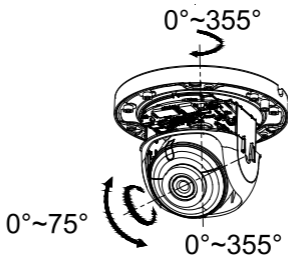

5. (Optional) If using a micro SD card (not included):

To remove the SD card, push the micro SD card forward.
The micro SD card will spring out.

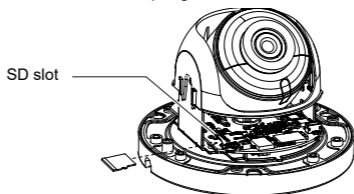

6. Reinstall the dome housing and tighten the Torx screws.

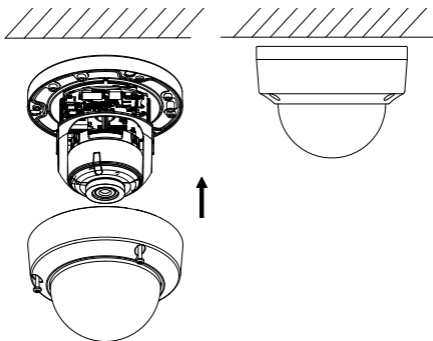

To mount the motorized lens dome camera on a ceiling:

1. Lift the camera body to separate it from the back box and the mounting adapter plate.

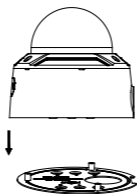

2. Separate the back box and camera from each other.

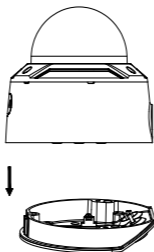

3. Unscrew the bubble from the camera body.

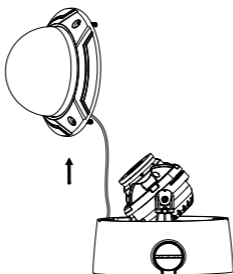

4. Mark four screw holes at the desired mounting location using the holes labeled number "2" on the mounting adapter plate.

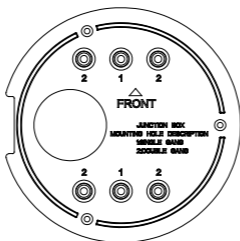

5. Secure the mounting adapter plate to the ceiling with the four supplied screws.

Note: Use expansion screws for a concrete ceiling and self-tapping screws for a wooden ceiling.

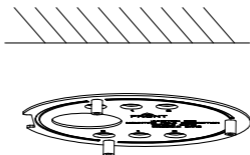

6. Route the cables through the sealing plugs in the back box.

- a) Pierce the sealing plugs on the back box.
- b) Thread cables through the sealing plugs.

Note:

- For RJ45 network interface, use the supplied cable routing tool.
- For the audio interface, first thread the audio cable through the sealing plug and then connect the audio connector to the cable.

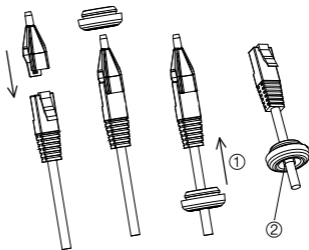

1. Drag the sealing plug back

2. Valgus

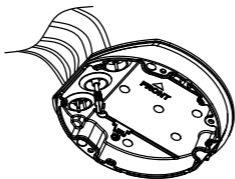

7. Align the "FRONT" marks on the back box and mounting adapter plate. Secure the back box to the mounting adapter plate with three screws.

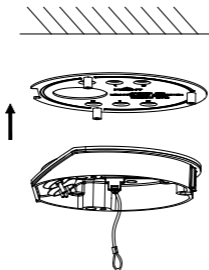

8. Hang the camera body on the safety lanyard.
9. Connect the cables to the corresponding plugs on the camera base.

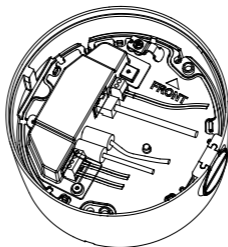

10. Fix the camera body to the back box with three screws.

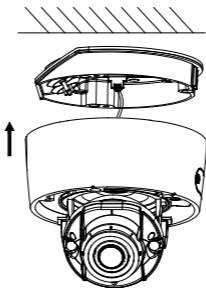

11. Loosen the tilt adjust screws and adjust the tilt position of the lens assembly within a range of 75 degrees. Retighten the tilt adjust screws. Rotate the dome liner to adjust the pan position within a range of 355 degrees. Rotate the lens assembly (0 to 355°) to obtain the desired surveillance angle.

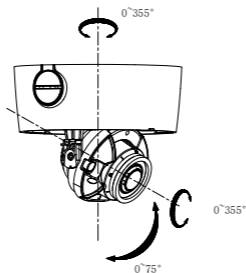

12. Reattach the bubble back to the camera body and align the arrow on the trim ring with the arrow on the dome body (only present on Rev. A models) to ensure that the bubble assembly is securely attached to the camera body. Tighten the bubble assembly with the Torx screw.

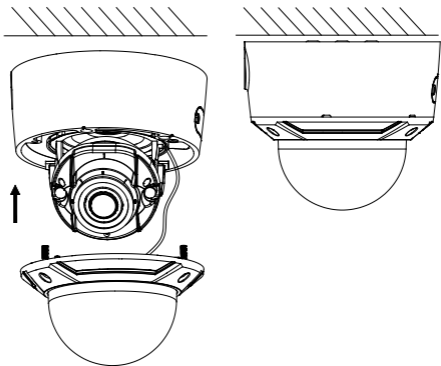

To mount the motorized lens dome camera on a wall:

Please refer to the installation guide provided with the TVD-CB7 mounting kit for instructions on mounting the motorized lens dome camera to the wall.

Mounting the wedge camera

To mount the fixed lens wedge camera on a surface:

1. Use the supplied template to mark out the mounting area. Drill mounting holes in the surface using the holes labeled number "1" on the drill template.

To route the cable harness through the mounting surface, cut a cable access hole in the mounting surface, referencing the letter "A" on the drill template. Skip this step if you want to route the cables on the surface.

- Secure the adapter plate to the mounting surface using the drill template.

Note: If required, remove the knockout on the side of the adapter plate to allow for cable access.

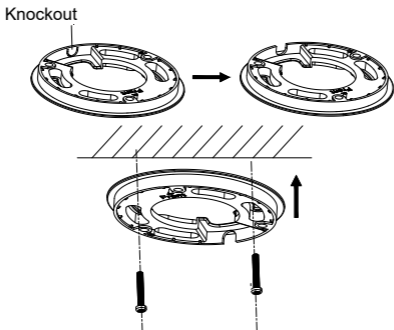

- Loosen the Torx screws with a Torx wrench (supplied) to remove the bubble assembly.

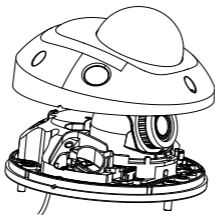

4. Mount the camera base to the adapter plate or directly to the mounting surface.

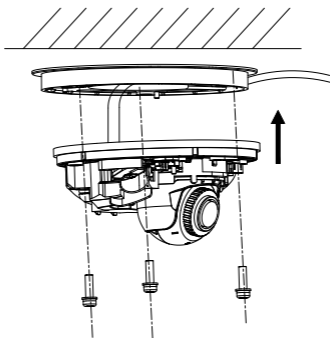

5. Loosen the locking screw, located beside the RESET button using the Phillips screwdriver. Adjust the view angle of the camera. The adjusting range of the panning is from -30° to 30° , the tilting is from 0° to 75° and the rotation is from 0° to 360° . If required, loosen the locking screw further to facilitate rotation.

Locking screw

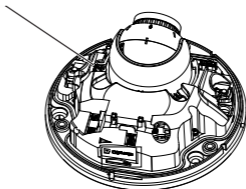

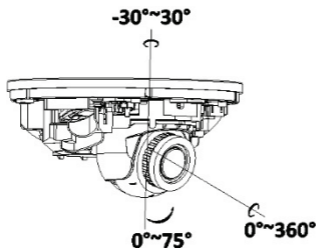

6. Reattach the bubble assembly to the camera base.

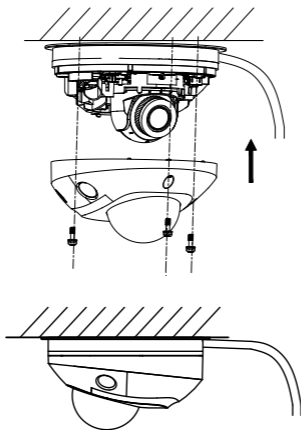

Using the protective water resistant connector cover

When installing a camera outdoors, it is recommended to use the supplied protective water resistant RJ45 connector cover. Additional protection can be achieved by adding weather resistant tape, not supplied.

Figure 7: Protective water resistant RJ45 connector cover components

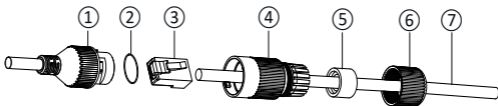

1. RJ45 connector on the cable harness
2. Rubber washer
3. RJ45 network plug
4. Protective connector sleeve
5. Rubber gasket
6. Screw cap
7. Network cable from router/switch

To install the protective water resistant RJ45 connector cover:

1. The RJ45 connector will not fit through the protective cover components. The cover assembly components should be placed on the network cable prior to crimping on the RJ45 plug. Feed the network cable (7) through

the screw cap (6), rubber gasket (5) (the flat portion of the rubber gasket goes towards the screw cap), and the protective connector sleeve (4) in the order shown in Figure 7.

2. Crimp an RJ-45 network plug (3) onto the end of the cable, ensuring that the twisted pairs of wires are in the correct order.
3. Place the rubber washer (2) onto the mating end of the RJ45 connector on cable harness (1).
4. Insert the RJ45 network plug (3) into the RJ45 connector (1).
5. Slide the rubber gasket (5) into the protective cover sleeve (4), and secure/tighten the screw cap (6) onto the protective connector sleeve (4).
6. Align the snap ridges inside protective connector sleeve (4) with the ridges inside of the RJ45 connector (1). Rotate the protective cover sleeve to tighten up against the RJ45 connector (1), as shown below.

- Align the snap and notch
- a) Insert (5) into (4)
b) Secure (6) with (4).

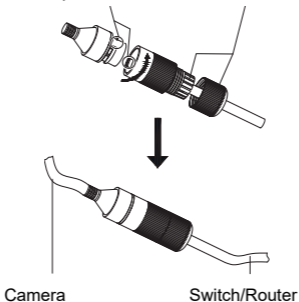

To install the weather resistant tape (not supplied):

1. Tightly wrap the tape around the RJ45 connector, as shown below. Keep in mind that the tape will stretch as you are wrapping the connector.

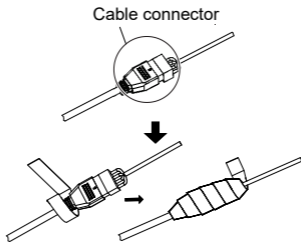

Note: Make sure that all bare wires are all firmly wrapped with the tape.

2. Press down on the tape, at each end of the connector to ensure a weather resistant seal.

➡ Press

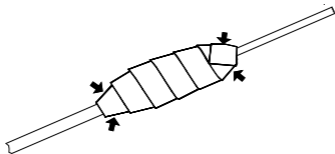

3. Also wrap weather resistant tape around any cable that has bare wires, as shown below.

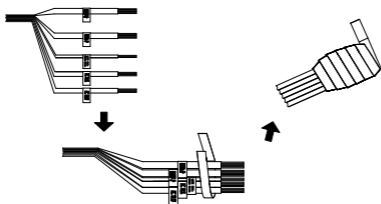

Note: Make sure that all the bare wires are firmly wrapped with weather resistant tape.

3. Press down on the tape to ensure a weather resistant seal.

➤ Press

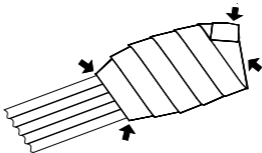

Network access

This guide explains how to configure the camera over the network with a web browser.

TruVision IP cameras can be configured and controlled using Microsoft Internet Explorer (IE) and other browsers. The procedures described use Microsoft Internet Explorer web browser.

Checking your web browser security level

When using the web browser interface, you can install ActiveX controls to connect and view video using Internet Explorer. However, you cannot download data, such as video and images due to the increased security measure. Consequently you should check the security level of your PC so that you are able to interact with the cameras over the web and, if necessary, modify the Active X settings.

Configuring IE ActiveX controls

You should confirm the ActiveX settings of your web browser.

To change the web browser's security level:

1. In Internet Explorer, click **Internet Options** on the **Tools** menu.
2. On the **Security** tab, click the zone to which you want to assign a web site under "Select a web content zone to specify its security settings".
3. Click **Custom Level**.
4. Change the **ActiveX controls and plug-ins** options that are signed or marked as safe to **Enable**. Change the **ActiveX controls and plug-ins** options that are unsigned to **Prompt** or **Disable**. Click **OK**.

— or —

Under **Reset Custom Settings**, click the security level for the whole zone in the **Reset To** box, and select **Medium**. Click **Reset**.

Then click **OK** to the **Internet Options Security** tab window.

5. Click **Apply** in the **Internet Options Security** tab window.

Windows Internet Explorer

Internet Explorer operating systems have increased security measures to protect your PC from any malicious software being installed.

To have complete functionality of the web browser interface with Windows 7, 8, and 10, do the following:

- Run the browser interface as an administrator in your workstation
- Add the camera's IP address to your browser's list of trusted sites

To add the camera's IP address to Internet Explorer's list of trusted sites:

1. Open Internet Explorer.
2. Click **Tools**, and then **Internet Options**.
3. Click the **Security** tab, and then select the **Trusted sites** icon.
4. Click the **Sites** button.
5. Clear the "Require server verification (https:) for all sites in this zone box".
6. Enter the IP address in the "Add this website to the zone" field.
7. Click **Add**, and then click **Close**.
8. Click **OK** in the Internet Options dialog window.
9. Connect to the camera for full browser functionality.

Activating the camera

When you first start up the camera, the Activation window appears. You must define a high-security admin password before you can access the camera. There is no default password provided.

You can activate a password via a web browser and via TruVision Device Manager (to find the IP address of the camera).

Activation via the web browser:

1. Power on the camera and connect the camera to the network.
2. Input the IP address into the address bar of the web browser, and click **Enter** to enter the activation interface.

Activation

User Name admin

Password

A valid password range must be between 8 and 16 characters. You can use a combination of numbers, lower and upper case letters, and special characters : _ - , . * & @ / \$? Space. The password must contain characters from at least two of these groups.

Confirm

OK

Note:

- The default IP address of the camera is 192.168.1.70.
 - For the camera to enable DHCP by default, you must activate the camera via TruVision Device Manager. Please refer to the following section, “Activation via TruVision Device Manager”.
3. Enter the password in the password field.

Note: A valid password range must be between 8 and 16 characters. You can use a combination of numbers, lower and upper case letters, and special characters : _ - , . * & @ / \$? Space. The password must contain characters from at least two of these groups. We also recommend that you reset your password regularly. For high security systems, it is particularly recommended to reset the password monthly or weekly for better protection.

4. Confirm the password.
5. Click **OK** to save the password and enter the live view.

Activation via *TruVision Device Manager*:

1. Run *TruVision Device Manager* to search for online devices.
2. Check the device status from the device list, and select the inactive device.



3. Enter the password in the password field, and confirm it.

Note: A valid password range must be between 8 and 16 characters. You can use a combination of numbers, lower and upper case letters, and special characters : _ - , . * & @ / \$? Space. The password must contain characters from at least two of these groups. We also recommend that you reset your password regularly. For high security systems, it is particularly recommended to reset the password monthly or weekly for better protection.

4. Click **OK** to save the password.

A pop-up window appears to confirm activation. If activation fails, confirm that the password meets the requirements and try again.

5. Change the device IP address to the same subnet with your computer by either modifying the IP address manually or checking the check box of Enable DHCP.

Modify Network Parameters	
<input type="checkbox"/> Enable DHCP	
IPv4 Address:	192.168.1.70
IPv4 Subnet Mask:	255.255.255.0
IPv4 Gateway:	192.168.1.1
IPv6 Address:	::
IPv6 Gateway:	::
IPv6 Prefix Length:	0
Server Port:	8000

6. Input the password and click the **Save** button to activate your IP address modification.

Using the camera with a TruVision recorder or another system

Please refer to the NVR/DVR user manuals for instructions on connecting and operating the camera with these systems.

Using the camera with TruVision Navigator

A camera must be connected to an TruVision NVR in order to be operated by TruVision Navigator. Please refer to the TruVision Navigator user manual for instructions on operating the camera with TruVision Navigator.

Specifications

TruVision IP fixed lens bullet cameras

Electrical

Voltage input	12 VDC, PoE (IEEE 802.3af)
Power consumption	2MP: Max. 7.5 W 4MP: Max. 7.5 W 8MP: Max. 8 W

Miscellaneous

Connectors	12 VDC Power Input, Network Port (PoE)
Operating temperature	-30 to +60°C (-22 to +140°F)
Dimensions	70 × 155.03 mm (2.76 x 6.1 in.)
Weight	410 g (0.9 lbs.)
Environmental rating	IP67

TruVision IP motorized lens bullet cameras

Electrical

Voltage input	12 VDC, PoE+ (IEEE 802.3at)
Power consumption	2MP: Max. 18 W 4MP: Max. 18 W 8MP: Max. 18 W

Miscellaneous

Connectors	12 VDC Power Input, Network Port (PoE+), Audio In/Out, Alarm In/Out,
Operating temperature	-30 to +60°C (-22 to +140°F)
Dimensions	144.13 × 332.73 mm (5.7 x 13.1 in.)
Weight	1.74 kg (3.8 lbs.)
Environmental rating	IP67, IK10

TruVision IP fixed lens turret dome

Electrical

Voltage input	12 VDC, PoE (IEEE 802.3af)
Power consumption	2MP: Max. 7.5 W 4MP: Max. 7.5 W 8MP: Max. 8 W

Miscellaneous

Connectors	12 VDC Power Input, Network Port (PoE)
Operating temperature	-30 to +60°C (-22 to +140 °F)
Dimensions	127.3 × 95.9 mm (5.01 × 3.78 in.)
Weight	620 g (1.37 lbs.)
Environmental rating	IP67

TruVision IP motorized lens turret dome

Electrical

Voltage input	12 VDC, PoE (IEEE 802.3af), Audio In/Out, Alarm In/Out
Power consumption	2MP: Max. 12.5 W 4MP: Max. 12.5 W 8MP: Max. 12.5 W

Miscellaneous

Connectors	12 VDC Power Input, Network Port (PoE)
Operating temperature	-30 to +60°C (-22 to +140 °F)
Dimensions	135.8 × 145.5 mm (5.4 × 5.7 in.)
Weight	1.2 kg (2.6 lbs.)
Environmental rating	IP67, IK10

TruVision IP fixed lens dome cameras

Electrical

Voltage input	12 VDC, PoE (IEEE 802.3af)
Power consumption	2MP: Max. 7.5 W 4MP: Max. 7.5 W 8MP: Max. 9 W

Miscellaneous

Connectors	Network Port(PoE), Audio In/Out, Alarm In/Out, 12 VDC Power Port
------------	--

Operating temperature	-30 to +60°C (-22 to 140°F)
Dimensions	111 × 82.4 mm (4.4 × 3.2 in.)
Weight	500 g (1.1 lbs.)
Environmental rating	IP67, IK10

TruVision IP motorized lens dome cameras

Electrical

Voltage input	12 VDC, PoE (IEEE 802.3af)
Power consumption	2MP: Max. 12 W 4MP: Max. 11.5 W 8MP: Max. 12 W

Miscellaneous

Connectors	Network Port(PoE), Audio In/Out, Alarm In/Out, 12 VDC Power Port
Operating temperature	-30 to +60°C (-22 to 140°F)
Dimensions	153.4 × 133.1 mm (6.0 × 5.2 in.)
Weight	1.33 kg (2.9 lbs.)
Environmental rating	IP67, IK10

TruVision IP fixed lens wedge cameras

Electrical

Voltage input	12 VDC, PoE (IEEE 802.3af)
---------------	----------------------------

Power consumption	2MP: Max. 10 W 4MP: Max. 10 W
-------------------	----------------------------------

Miscellaneous

Connectors	12 VDC Power Input, Network Port (PoE)
------------	--

Operating temperature	-30 to +60 °C (-22 to +140 °F)
-----------------------	--------------------------------

Dimensions	110 × 56.4 mm (4.33 × 2.22 in.)
------------	------------------------------------

Weight	395 g (0.87 lbs.)
--------	-------------------

Environmental rating	IP66, IK8
----------------------	-----------

Pin definitions

There are eight wires on a standard UTP/STP cable and each wire is color-coded. The following shows the pin allocation and color of straight and crossover cable connection:

Figure 8: Straight-through cable

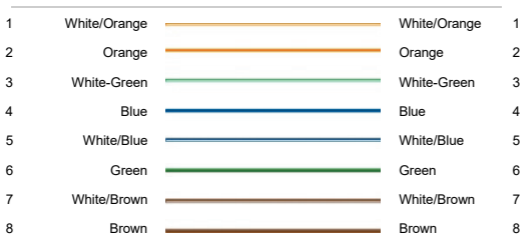
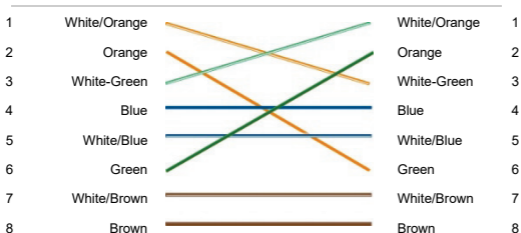

Figure 9: Cross-over cable



Please make sure your connected cables have the same pin assignment and color as above before deploying the cables in your network.

