

Extinguishant Release Panel

Sigma ZXT

Installation Manual



Safety

Suppliers of articles for use at work are required under section 6 of the Health and Safety at Work Act 1974 to ensure as reasonably as is practical that the article will be safe and without risk to health when properly used.

An article is not regarded as properly used if it is used 'without regard to any relevant information or advice' relating to its use made available by the supplier.

This product should be installed, commissioned and maintained by trained service personnel in accordance with the following:

- (i) Regulations for electrical equipment in buildings specific to the country of use.
- (ii) Codes of practice
- (iii) Statutory requirements
- (iv) Any instructions advised by the manufacturer.

According to the provisions of the Act you are therefore requested to take such steps as are necessary to ensure that you make any appropriate information about this product available to anyone concerned with its use.

Suppliers of articles for use at work are required under section 6 of the Health and Safety at Work Act 1974 to ensure as reasonably as is practical that the article will be safe and without risk to health when properly used.

An article is not regarded as properly used if it is used 'without regard to any relevant information or advice' relating to its use made available by the supplier.

This product should be installed, commissioned and maintained by trained service personnel in accordance with the following:

- (i) IEE regulations for electrical equipment in buildings
- (ii) Codes of practice
- (iii) Statutory requirements
- (iv) Any instructions specifically advised by the manufacturer

According to the provisions of the Act you are therefore requested to take such steps as are necessary to ensure that you make any appropriate information about this product available to anyone concerned with its use.

This equipment is designed to operate at 230V AC 50/60Hz mains supplies, class 1 construction. As such it must be connected to a protective earthing conductor in the fixed wiring of the installation and a readily accessible double pole disconnect device meeting the requirements of EN60950/IEC950 which disconnects live and neutral simultaneously shall be incorporated in the fixed wiring.

Switch disconnect devices such as MK Sentry 63A or similar are suitable for this. Failure to ensure that all conductive accessible parts of this equipment are adequately bonded to the protective earth will render the equipment unsafe.

This Control Panel is environmental class A and is designed for indoor use only at temperatures between -10°C and +45°C with a maximum relative humidity of 95%. The IP rating for the enclosure is IP30.

Operation outside of these limits may render the equipment unsafe.

Compliance

Sigma ZXT is compliant with the following standards:

EN54-2 and EN54-4 Fire Detection and Fire Alarm Systems - Control and Indicating Equipment

In addition to the standard EN54-2 requirements the following options with requirements have been included in the Control Panel:

Output to alarm devices to enable an audible warning to be sounded throughout the premises upon the detection of a fire condition or the operation of a manual call point. EN54-2 Section 7.8.

Test condition to allow the automatic resetting of zones in alarm for testing purposes. EN54-2 Section 10.

Delay of the actioning of fire alarm devices (sounders) so that an alarm may be verified before a premise is evacuated. EN54-2 Section 7.11

In addition to the requirements of EN54-2, Sigma ZXT Control Panels have a voltage free relay contact for fire which operates upon a fire condition. This is to be used for local control and signalling.

EN12094-1 Fixed fire-fighting systems - Components for gas extinguishing systems - Part 1: Requirements and test methods for electrical automatic control and delay devices.

In addition to the standard EN12094-1 requirements the following options with requirements have been included in the Control Panel:

EN12094-1 Section 4.17. Delay of extinguishing signal of up to 60 seconds.

EN12094-1 Section 4.18. Signal representing the flow of extinguishing agent to indicate the released condition.

EN12094-1 Section 4.19. Monitoring of the status of components by way of a low pressure switch input.

EN12094-1 Section 4.20. Emergency hold device to enable the extinguishant delay time to be extended.

EN12094-1 Section 4.21. Control of flooding time to deactivate the releasing output after a set period of time.

EN12094-1 Section 4.23. Manual only mode to disable the release of extinguishant via automatic detection devices.

EN12094-1 Section 4.25. Extinguishing signals to spare cylinders enables the switching to a spare set of cylinders following a discharge to return the system to a functional state.

EN12094-1 Section 4.27. Emergency Abort device to inhibit the extinguishing signal until the emergency abort device has been de-activated and the Panel has been reset.

EN12094-1 Section 4.30. Activation of alarm devices with different signals to indicate pre-discharge and released warnings using different sounds.

Default panel settings provide EN54-2 compliance:

BUZZER O/P: Enabled/Disabled This must be set to **ENABLED**.

MAINS FLT RLY DLY: OFF/30m This must be set to **OFF**.

FAULT RELAY: ENABLED/DISABLED This must be set to **ENABLED**.

FIRE RELAY: ENABLED/DISABLED. This must be set to **ENABLED**.

EARTH FAULT: ENABLED/DISABLED This must be set to **ENABLED**.

Important! Any deviation from these settings and compliance EN54-2 is void.

Disclaimer

In no event shall The Manufacturer be liable for any damages or injury of any nature or kind, no matter how caused, that arise from the use of the equipment referred to in this manual. Strict compliance with the safety procedures set out and referred to in this manual, and extreme care in the handling or use of the equipment, are essential to avoid or minimise the chance of personal injury or damage to the equipment.

The information, figures, illustrations, tables, specifications, and schematics contained in this manual are believed to be correct and accurate as at the date of publication or revision. However, no representation or warranty with respect to such correctness or accuracy is given or implied and The Manufacturer will not, under any circumstances, be liable to any person or corporation for any loss or damages incurred in connection with the use of this manual. The information, figures, illustrations, tables, specifications, and schematics contained in this manual are subject to change without notice.

Unauthorised modifications to the fire detection system or its installation are not permitted, as these may give rise to unacceptable health and safety hazards.

By installing this equipment on a computer network, the owner accepts full and unequivocal responsibility for ensuring that it is protected against all cyber threats and illegal tampering during the lifetime of the equipment. Any software forming part of this equipment should be used only for the purposes for which The Company supplied it. The user shall undertake no changes, modifications, conversions, translations into another computer language, or copies (except for a necessary backup copy). In no event shall The Manufacturer be liable for any equipment malfunction or damages whatsoever, including (without limitation) incidental, direct, indirect, special, and consequential damages, damages for loss of business profits, business interruption, loss of business information, or other pecuniary loss, resulting from any violation of the above prohibitions.

Section 1	
Introduction	1
Section 2	
Overview	2
Section 3	
Panel Installation	6
Before You Begin	6
Installation checklist	6
Fascia Panel/PCB Assembly Removal	7
Mounting the Panel	9
Control Panel Fascia Wiring	11
Electrical Connections	12
Enclosure Earth	12
Power Supply	13
Input Circuits	13
Detection Circuits	13
BS5839 Detector removal	14
Intrinsically Safe (I.S.) Detection Zones	14
Monitored Inputs	15
Non-Monitored Inputs	17
P1 & P2 Prog I/P's	17
Output Circuits	18
Sounder circuits	18
Extinguishing Outputs	19
Operating of Dual Extinguishing Outputs	19
Solenoid Wiring	20
Igniting Actuator Wiring	20
Relay Outputs	21
AUX 24V DC Supply	22
RS485 Output	22
Section 4	
Controls	23
Control Panel Fascia	23
Alarm status	23
General status	23
Extinguishant status	23
LED Indications	24
Alarm Status Indications	24
General Status Indications	25
Extinguishing Status Indications	26
Liquid Crystal Display (LCD) Indications	28
Dynamic Displays	28
User Controls	31
LCD Navigation Push Button	31
Silence Buzzer	31
Silence Alarm	31
Alarm Re-sound	32
Reset	32
Manual Release	32
Control Key-Switches	33
Internal Indicators and Controls	34
Watchdog Reset	34
Processor Reset	34
Term. Exting. (Terminate Extinguishing)	34
Memory Lock	34

Section 5	
Panel Configuration	35
Access Levels	35
Access Level 1	35
Access Level 2	36
Access Level 3 (Engineering)	41
Connection to LE2	53
Section 6	
Adding/Removing Status Indicators & Ancillary Boards	54
Adding a Status Unit to a ZXT	54
Removing a Status Indicator	57
Adding an Ancillary Board to a ZXT	58
Removing an Ancillary Board	60
Section 7	
Maintenance & Assistance	61
If You Need Help	61
Limited Returns and Repairs Policy	61
In-Warranty Items	61
Damaged Goods	61
Component Failure	61
Service Replacement Items	61
Repair Warranties	62
Out Of Warranty Items	62
Customer Repairs	62
Section 7	
LCD Menu Structure	63
Appendix A	
Specification	67
Mechanical	67
Electrical	67
Environmental	70
Battery Calculation	71
Appendix B	
Glossary	72

Section 1**Introduction**

Sigma ZXT is an advanced Extinguishing Control Panel designed for monitoring and control of gaseous fire suppression systems.

Flexible and easy to use, clear status information is provided using a combination of LED's and Liquid Crystal Display (LCD). The LCD also provides access to configuration menus enabling easy set-up as well as Event Log information.

Three conventional detection zones provide the alarm stimulus required to activate the release of extinguishant. Any single zone or combination of multiple zones, can be configured to contribute to the release of extinguishant.

Programmable volt-free relay outputs are provided which enable remote status signalling to other equipment.

Sigma ZXT functionality can be expanded by the addition of up to 7 Status Indicator Units providing remote indication and controls and up to 7 Ancillary Boards providing additional status outputs.

Section 2 Overview

The figure below provides an overview Sigma ZXT Panel hardware.

Figure 2-1
Compact Panel Features

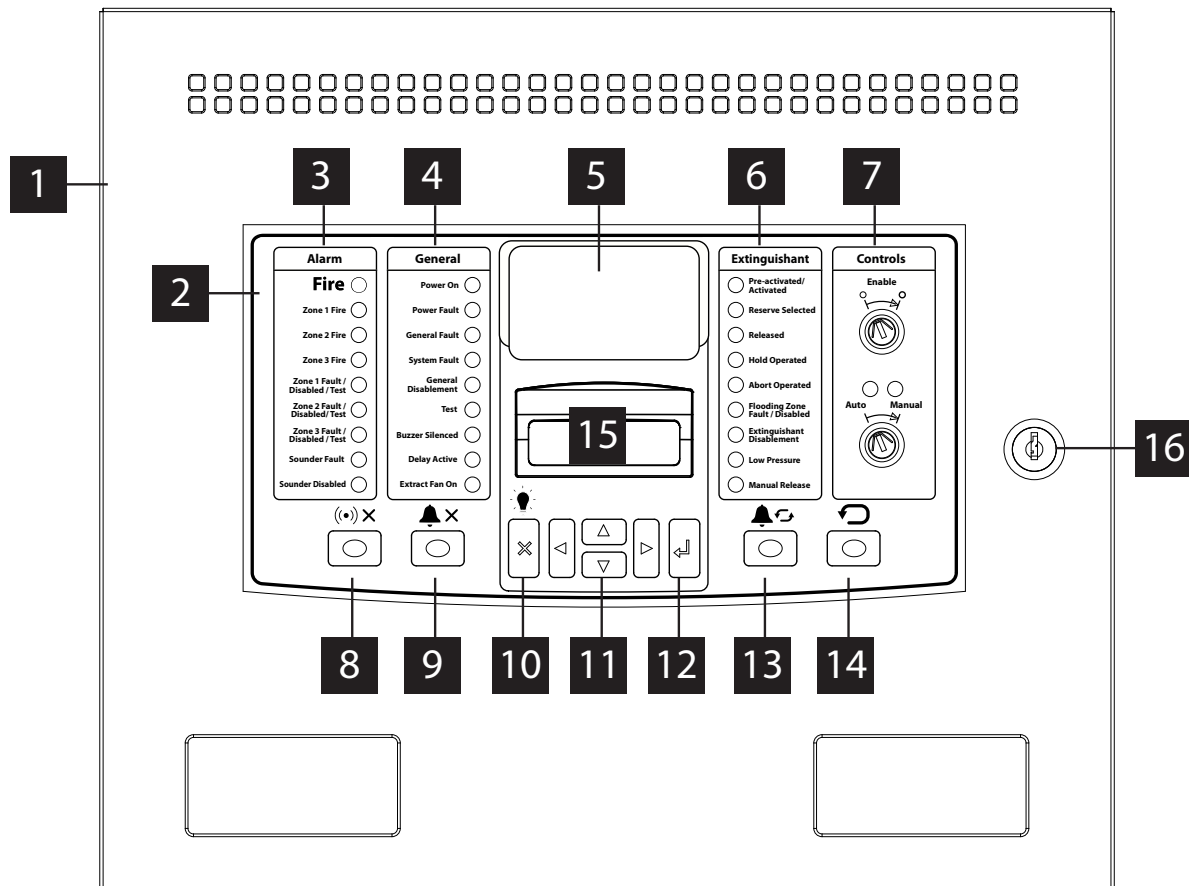

- | | |
|---|--|
| 1. Panel enclosure | 11. LCD navigation push buttons |
| 2. Control Panel fascia | 12. Enter push-button |
| 3. Alarm status LED indicators | 13. Alarm Re-Sound push-button |
| 4. General status LED indicators | 14. Reset push-button |
| 5. Liquid Crystal Display (LCD) | 15. Manual Release push-button with protective cover |
| 6. Extinguishant status LED indicators | 16. Panel enclosure lock |
| 7. Control key-switches | |
| 8. Silence buzzer push button | |
| 9. Alarm push button | |
| 10. Lamp Test and menu exit push-button | |

Figure 2-2
Compact Panel Internal Features

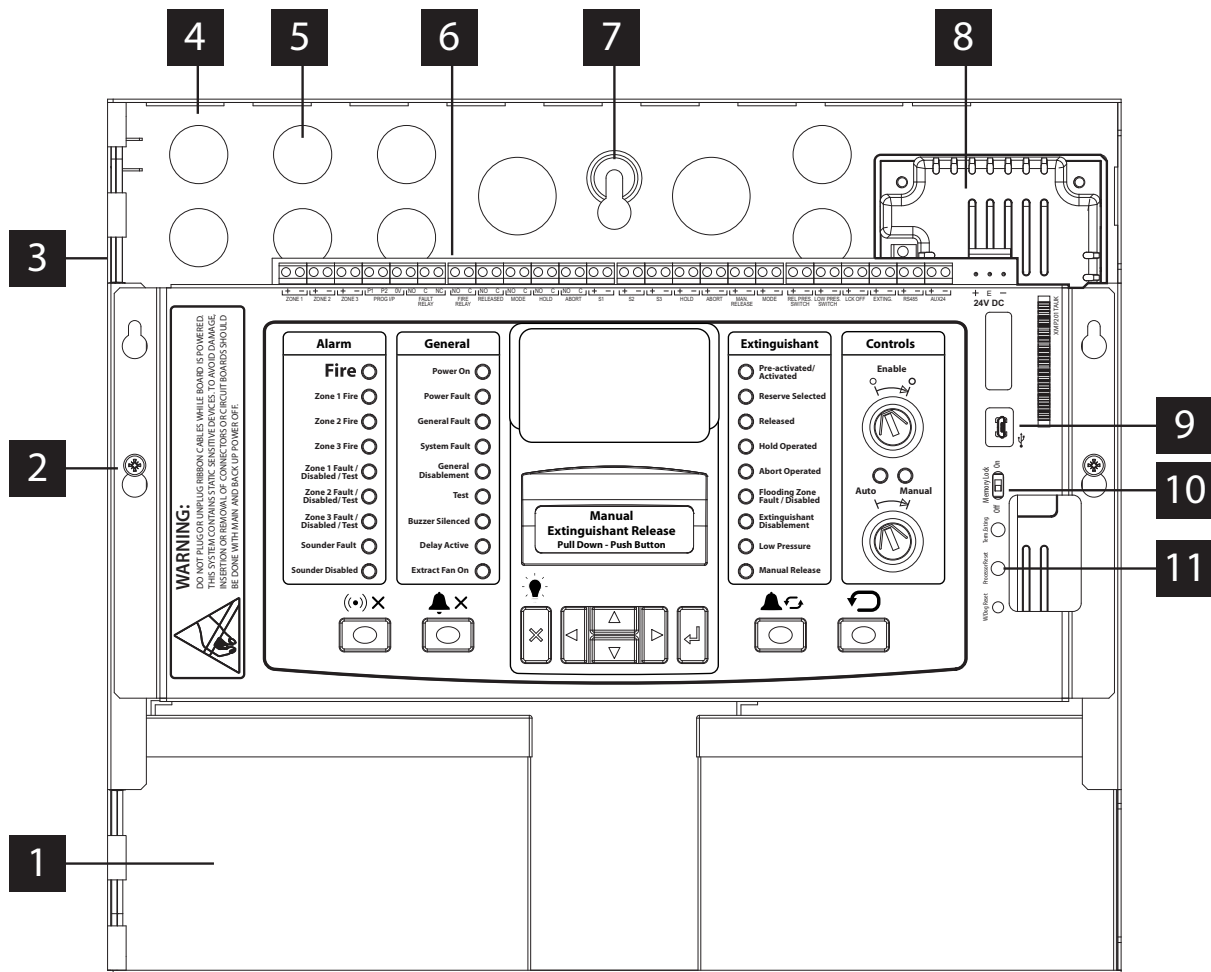

- | | |
|--|--------------------------------|
| 1. Standby batteries (x2) | 7. Enclosure fixing point (x3) |
| 2. Controls Panel fascia fixings (x2) | 8. 2.6A Power supply |
| 3. Enclosure hinge points (x2) | 9. Mini USB connection |
| 4. Enclosure back-box | 10. Memory lock toggle switch |
| 5. Enclosure cable entry points (knock-outs) | 11. Reset micro-switches |
| 6. Control Panel wiring terminals | |

Figure 2-3
Large Panel Fascia Features

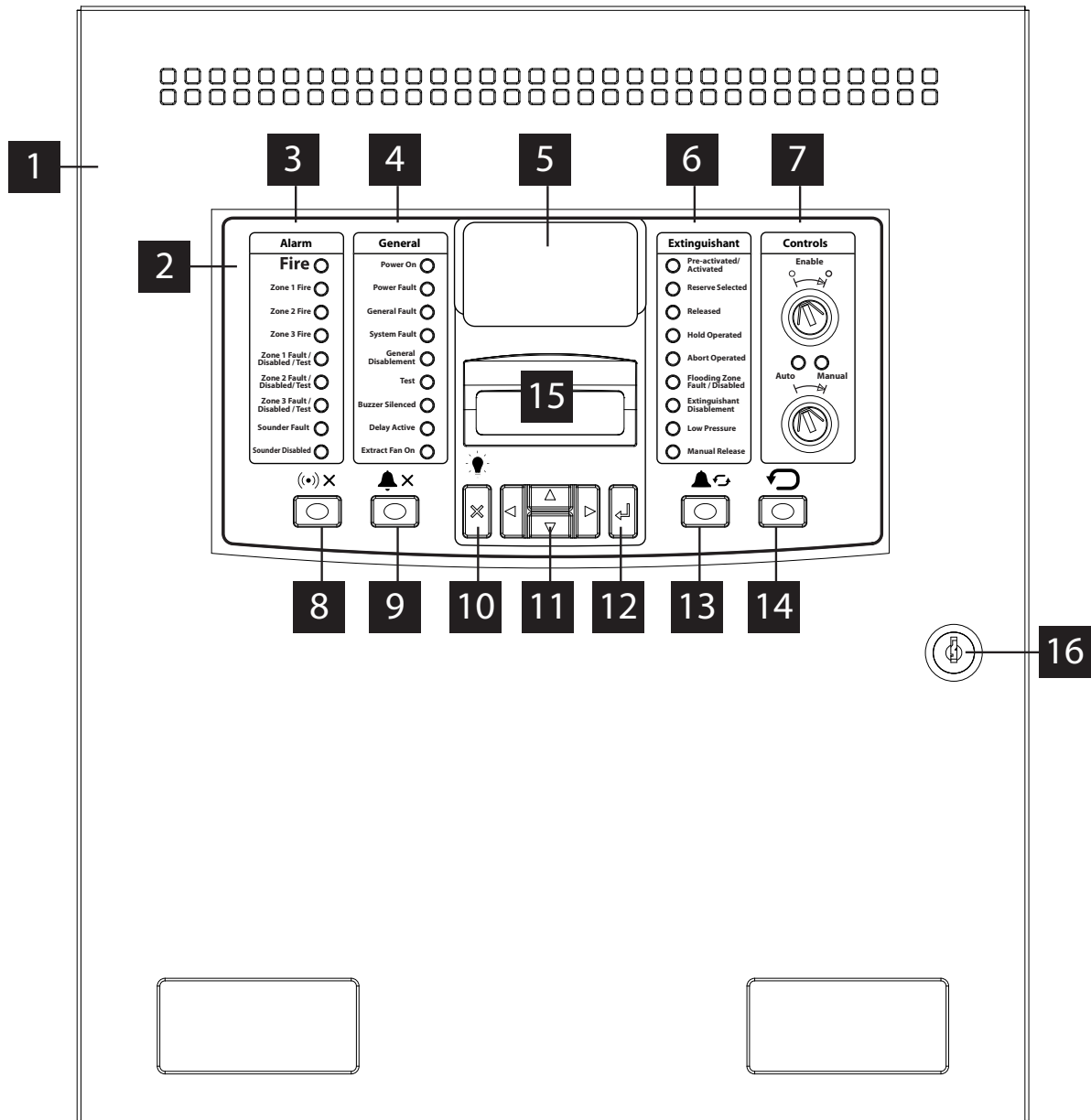

- | | |
|---|---------------------------------|
| 1. Panel enclosure | 11. LCD navigation push-buttons |
| 2. Controls Panel fascia | 12. Enter push-button |
| 3. Alarm status LED indicators | 13. Alarm Re-Sound push button |
| 4. General status LED Indicators | 14. Reset push-button |
| 5. Liquid Crystal Display (LCD) | 15. Manual Release |
| 6. Extinguishant status LED indicators | 16. Panel enclosure lock |
| 7. Control key-switches | |
| 8. Silence buzzer push-button | |
| 9. Silence Alarm button | |
| 10. Lamp Test and menu exit push-button | |

Figure 2-4
Large Panel internal layout

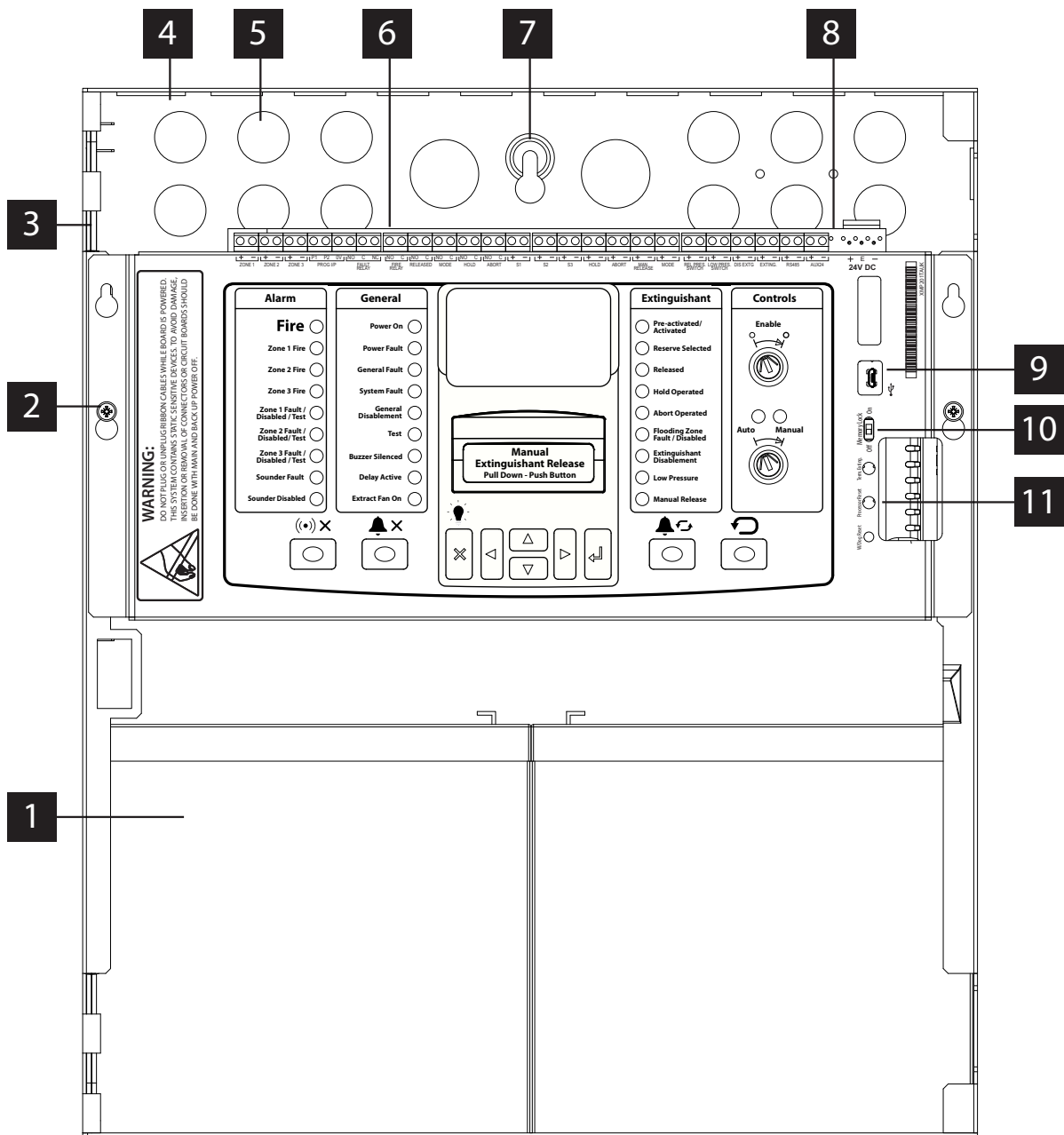

- | | |
|--|--|
| 1. Standby batteries (x2) | 7. Enclosure fixing point (x3) |
| 2. Controls Panel fascia fixings (x2) | 8. 5.25A Power supply (behind controls fascia) |
| 3. Enclosure hinge points (x2) | 9. Mini USB connection |
| 4. Enclosure back-box | 10. Memory lock toggle switch |
| 5. Enclosure cable entry points (knock-outs) | 11. Reset micro-switches |
| 6. Control Panel wiring terminals | |

Section 3

Panel Installation

This section describes the installation process.

Before You Begin

Before you begin the installation, take time to review the installation information, gather the required items and complete the tasks listed below.

CAUTION!

The installation must be performed by qualified personnel familiar with electronic components. Electronic components within the Control Panel are vulnerable to damage from electronic discharge. Ground straps must be worn by installers before handling circuit boards to prevent damage from electronic discharge.

- Create a plan and checklist before starting the installation process.
- Select an environment that is suitable for operating the Control Panel. The site chosen for mounting the Control Panel should be clean, dry, flat and not subject to excessive shock, vibration or heat. Ensure after the installation the Control Panel enclosure is free from any debris.
- Verify the following items are present:

Item	Quantity	Description
Enclosure	1	Mild steel enclosure comprising of lid, back-box, hinge pins, label plates, Panel lock.
Control Panel	1	Control Panel assembly (fascia plate) complete with printed circuit board (PCB).
Power supply	1	2.6A or 5.25A power supply.
Earth connections	1	Green/yellow earth wires fitted with spade connectors, between enclose lid and back-box.
Standby battery leads	1	For connecting standby batteries.
Quick Start Guide	1	Essential Setup information and gateway to Product Manual.
End of line diodes	4	Fitted to sounder and solenoid circuits for monitoring
Battery leads	1	Used to connect standby batteries.
Keys	4	2x enclosure lock, 2x enable controls.
End of line resistors	10	Fitted to monitored input terminals for monitoring.

Installation checklist

- Create an installation plan and checklist.
- Remove the Panel from its packaging and check the contents.
- Remove the Control Panel fascia/PCB assembly.
- Mount the enclosure to the premises wall using appropriate fixings.
- Refit Control Panel fascia/PCB assembly.
- Thread external cabling into the enclosure and make connections to Control Panel terminals.
- Place standby batteries in base of enclosure and make connections.
- Apply mains power.
- Configure.
- Test installation.

Fascia Panel/PCB Assembly Removal

To assist the installation it is recommended that the Control Panel fascia is removed, this prevents potential damage and provides additional working space.

Steps to remove fascia plate:

Important! For safety reasons mains power must be disconnected before attempting to remove the fascia plate.

1. Disconnect the DC supply to the fascia PCB by removing the pluggable connector mounted as shown in figure 3-1

Figure 3-1
Disconnect DC Supply

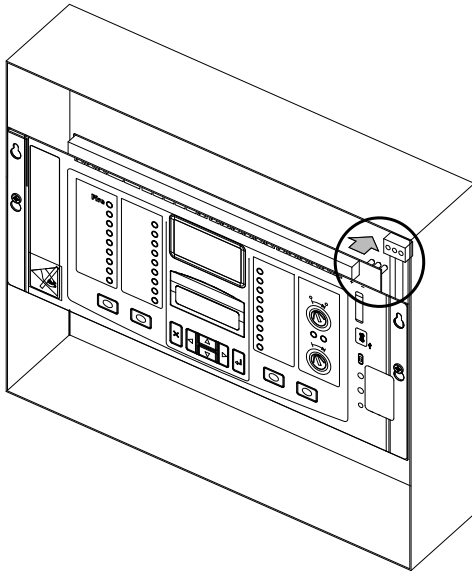

2. Disconnect the 14-way PSU monitoring ribbon cable from the Fascia PCB as shown in figure 3-2.

Figure 3-2
Disconnect 14-Way Cable

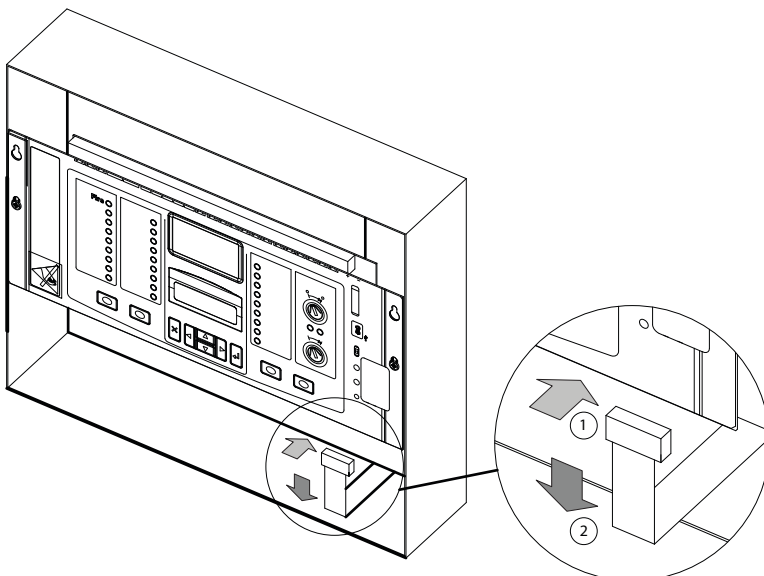

3. Locate the two screws securing the fascia plate to the enclosure. Loosen the screws enough to allow the fascia plate to be removed as shown in fig 3-3.

Figure 3-3
Remove Fascia Plate

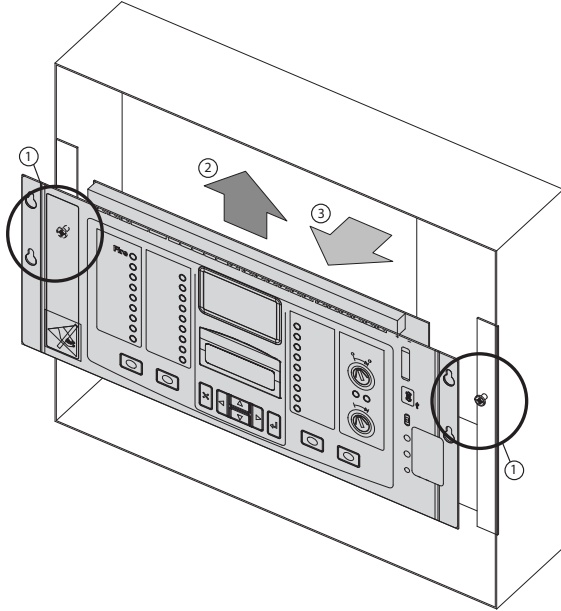

4. Store the fascia plate in safe location until required.

5. To refit the fascia plate follow steps 1 to 3 in reverse.

Mounting the Panel

The control panel should be located in an accessible place as agreed with the end user.

Mounting should be at a height suitable for viewing status displays and operation of controls. Mounting surfaces should be clean, dry and flat, uneven mounting surfaces can cause distortion of the enclosure and internal PCBs leading to problems.

5mm screws or bolts should be used along with suitable wall plugs to secure the control panel to the wall.

Control panels should not be mounted inside other enclosures, near sources of excessive heat or close to any cables or equipment of high voltage or high frequencies.

External cabling should enter the control panel through suitable cable glands fitted in the knock-outs provided.

Note: Enclosures vary. Figure 3-4 and Figure 3-5 show enclosure back box dimensions and fixing centres.

Figure 3-4
XM2 Back Box Dimensions (mm). Drawing Not to Scale.

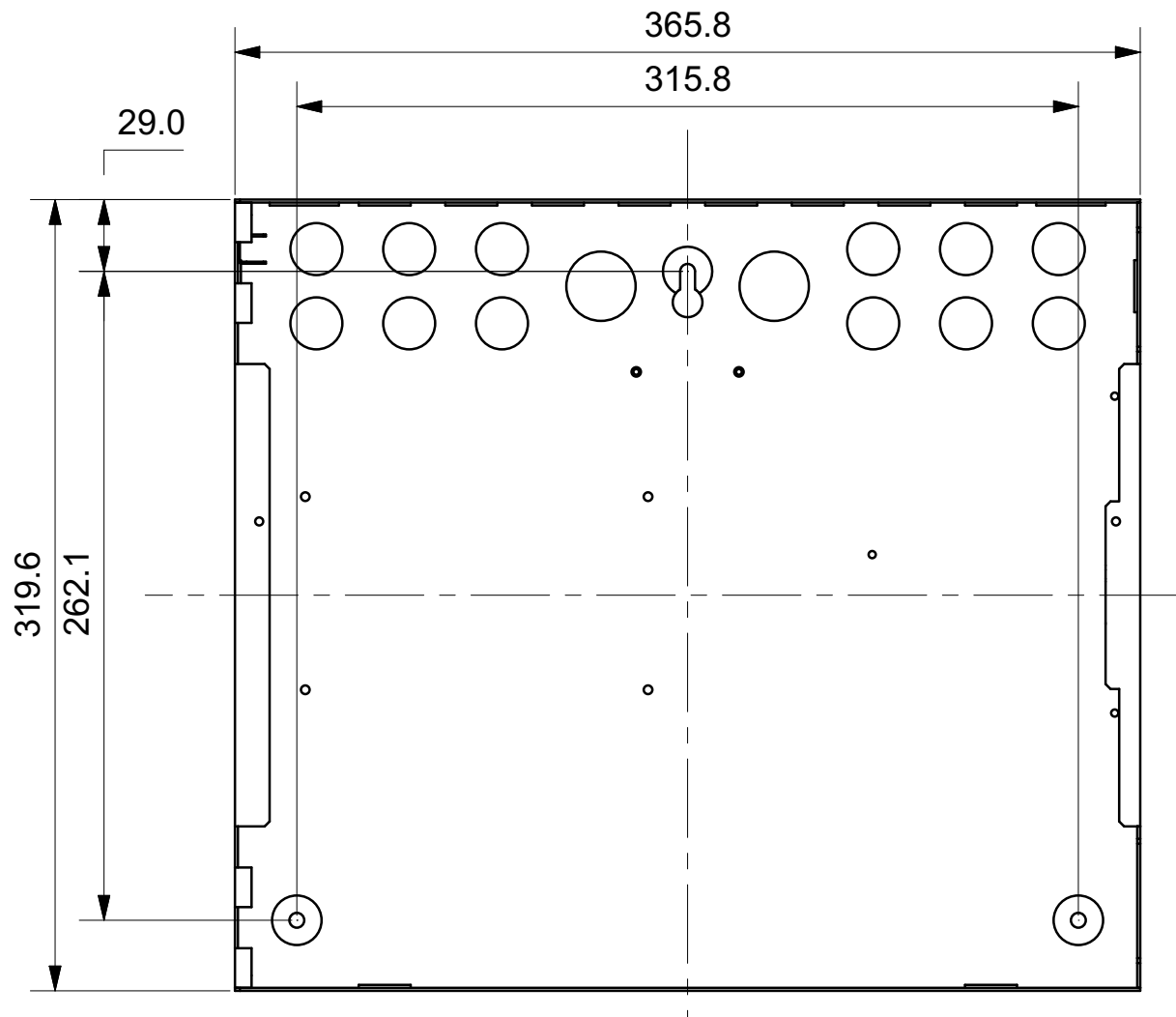
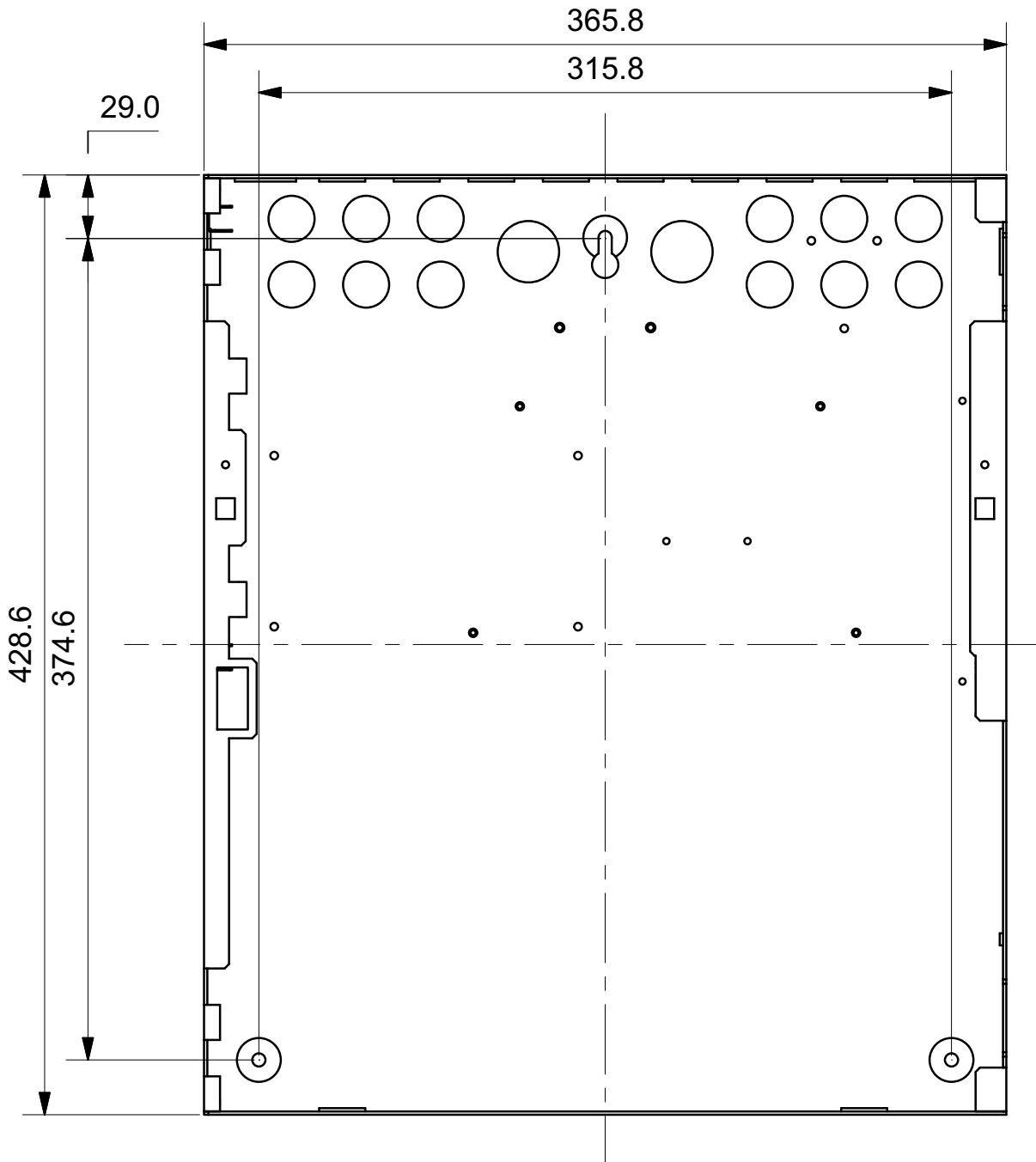

Figure 3-5
XM3 Back Box Dimensions (mm) Drawing Not to Scale.



Control Panel Fascia Wiring

Shielded fire alarm cable such as FP200 and metal cable glands must be used for all circuits connected to the Panel, the resistance of any core of the cable must not exceed 25 Ohms.

Fire alarm cables must be bonded securely to the enclosure via a metal cable gland.

Multiple size knock-out cable entries are provided in the top of the enclosure back box (12 x M20, 2 x M22) and where possible wiring should enter the enclosure using these knock-outs. Cables should be formed tidily to the appropriate terminals leaving only enough wire to ensure that there is no strain on the PCB.

Wiring must not go across the front of the circuit board plate or between the plate and the circuit board.

Figure 3-6
Wiring practice

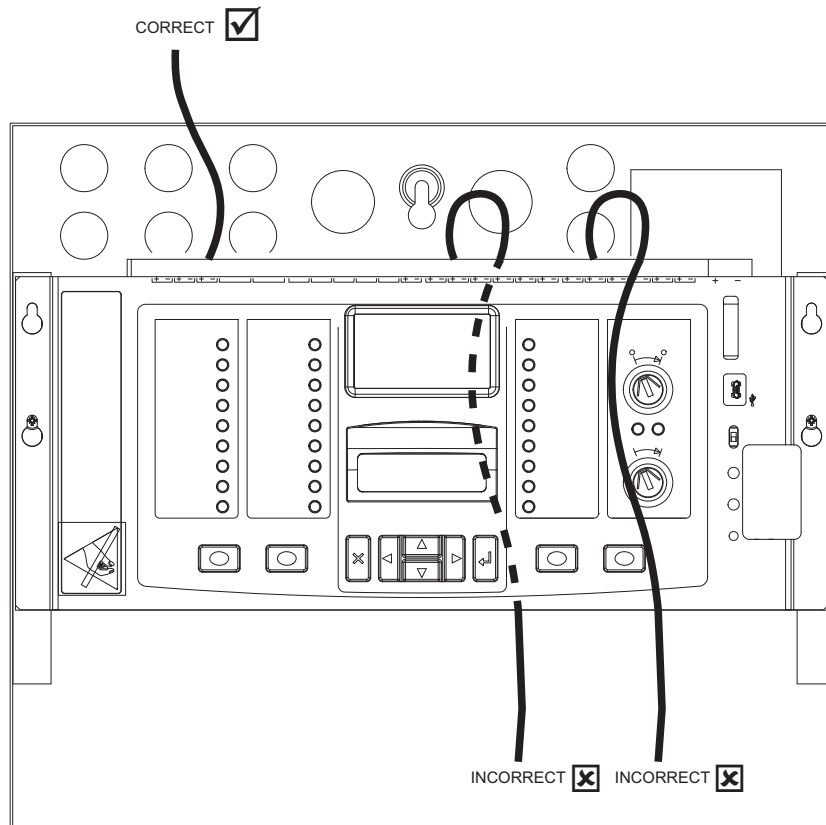

Electrical Connections

All connections for field wiring are to a single row of screw terminals along the top of the Control Panel circuit board.

Figure 3-7
Screw Terminals

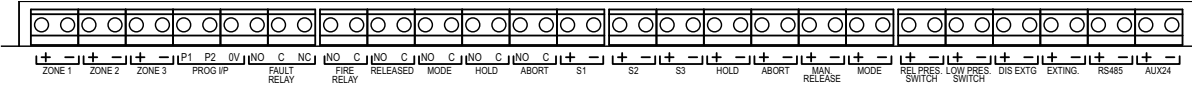

The table below shows terminal designations.

Terminal No.	Function	Conne- tion	Terminal No.	Function	Conne- tion	Terminal	Function	Conne- tion.
TP1	ZONE 1	(+)	TP19	HOLD	NO	TP37	REL PRES. SWITCH	(+)
TP2		(-)	TP20		C	TP38		(-)
TP3	ZONE 2	(+)	TP21	ABORT	NO	TP39	LOW PRES. SWITCH	(+)
TP4		(-)	TP22		C	TP40		(-)
TP5	ZONE 3	(+)	TP23	S1	(+)	TP41	DIS EXTG	(+)
TP6		(-)	TP24		(-)	TP42		(-)
TP7	PROG I/P	P1	TP25	S2	(+)	TP43	EXTING.	(+)
TP8		P2	TP26		(-)	TP44		(-)
TP9		0V	TP27	S3	(+)	TP45	RS485	(+)
TP10	FAULT RELAY	NO	TP28		(-)	TP46		(-)
TP11		C	TP29	HOLD	(+)	TP47	AUX 24	(+)
TP12		NC	TP30		(-)	TP48		(-)
TP13	FIRE RELAY	NO	TP31	ABORT	(+)	TP60	24V DC	E
TP14		C	TP32		(-)			
TP15	RELEASED	NO	TP33	MAN RELEASE	(+)			
TP16		C	TP34		(-)			
TP17	MODE	NO	TP35	MODE	(+)			
TP18		C	TP36		(-)			

Enclosure Earth

Important! To maintain continuity of Earth, a wire is provided connected between the enclosure earth terminal block (found on the inside rear of the enclosure back-box) and mains Earth.

This connection must be maintained and in place prior to panel operation.

Power Supply

Sigma ZXT has two power supply options (specified at time of purchase):

2.6A Power supply	
Input voltage	230V AC
Output voltage	20.3 - 28.3V DC
Power rating	2.6A
Standby batteries (max.)	2 x 7Ah SLA

5.25A Power supply	
Input voltage	230V AC
Output voltage	19 - 28.5V DC
Power rating	5.25A
Standby batteries (max.)	2 x 18Ah SLA

Either version provides power for the main PCB as well as monitoring and charging of back-up batteries.

The DC output of the power supply is connected to a pluggable terminal block located in the upper right of the main PCB. The pluggable terminal facilitates the removal of the fascia plate/PCB assembly.

Important! Mains input to the power supply must be disconnected before removal of the pluggable terminal block.

Fault monitoring of the power supply is provided by an 14-way IDC cable harness between the power supply and the main Panel PCB.

Sigma ZXT is offered in two enclosure versions. The XM2 version accommodates 2 x 7Ah SLA batteries. The XM3 version can accommodate up to 2 x 18Ah SLA batteries.

Input Circuits

The Sigma ZXT is provided with various monitored and non-monitored input circuits, this sub-section provides details on functionality and wiring for each of the inputs.

Detection Circuits

Three conventional detection circuits are provided for the connection of conventional type automatic detection devices.

Each conventional detection zone circuit provides a nominal 21.3V DC (+/-0.1V) to power conventional Detectors.

Conventional detection zone circuit must be wired as a single, two core radial circuit monitored by means of a 6k8Ω end of line (EOL) resistor. EOL monitoring resistors are supplied fitted in the Control Panels' terminals and must be removed and installed in the last device on the zone circuit.

The 6K8Ω EOL resistor should be left connected to the terminals of any unused zones.

The number of detection devices supported per zone will vary dependent on detector manufacturer. The current rating of the zone circuit and zone devices should be reviewed at system design stage.

To ensure compliance with circuit monitoring requirements no more than 32 devices should be fitted to one zone.

Figure 3-8
Detection Circuit Diagram

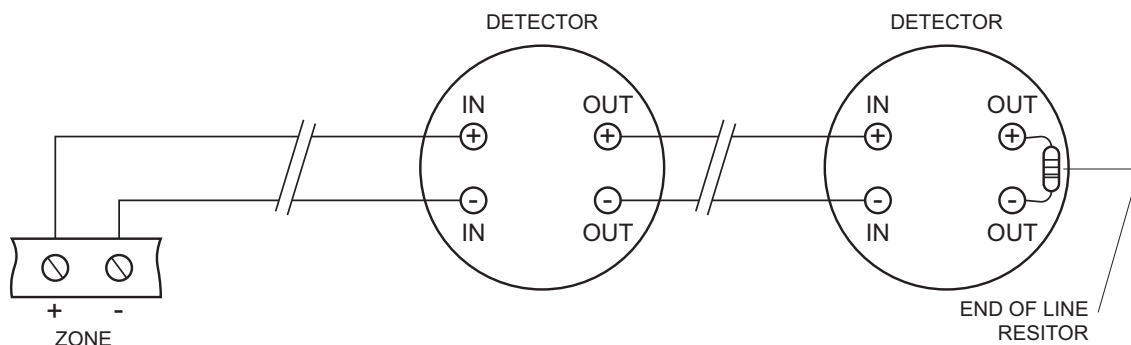

BS5839 Detector removal

Systems required to comply with BS5839 Part 1 detector removal requirements must be fitted with a 47uF capacitor (provided in spares bag) across the zone terminals and an LCMU active end of line monitoring device at the end of the zone in place of the end of line resistor. Detectors installed on the zone must use detector bases fitted with a schottky diode, circuit wiring details are shown in fig 3-9.

Figure 3-9
BS5839 Part 1 Detector Removal Zone Wiring

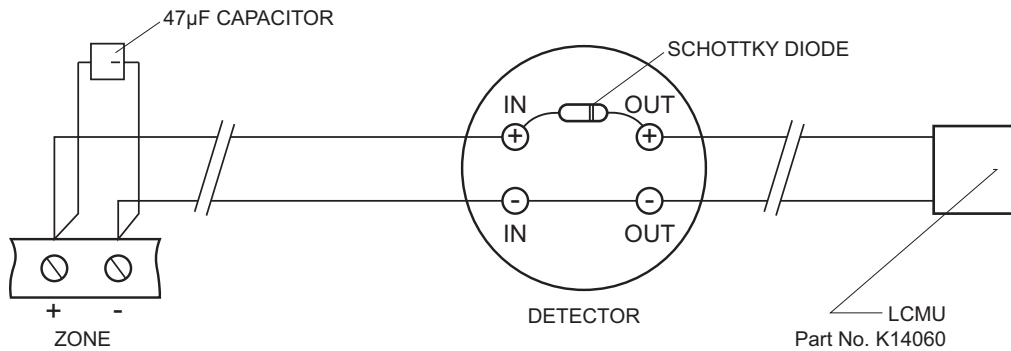

Intrinsically Safe (I.S.) Detection Zones

Sigma ZXT supports the use of I.S. barriers for connecting to intrinsically safe detection devices installed within hazardous areas.

Important! Only I.S. certified detectors may be installed within hazardous areas and must be connected to the ZXT Control Panel through a compatible I.S. barrier - MTL5561.

Connection of the I.S. barrier changes the characteristics of the detection circuit, to enable correct monitoring of the circuit the Panel zones must be configured for use with I.S. barriers (see the configuration section of this manual).

The number of detection devices that can be connected to an I.S. detection zone is limited by the I.S. approval system diagram which should be supplied by the detector manufacturer. The power rating of the end of line resistor will be dependent upon the Zone classification rating (Gas class) this will be specified on the system diagram.

Figure 3-10
Intrinsically Safe Detection Zone Diagram

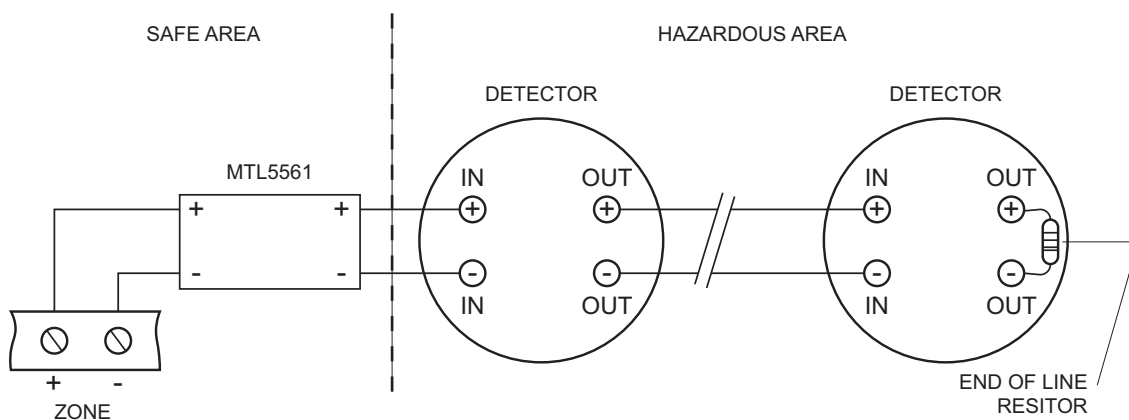

For detection zone configuration, please go the Configuration section of this manual.

Monitored Inputs

Sigma ZXT is provided with many monitored inputs for the connection of external system accessories such as pressure switches, key-switches etc.

Monitored inputs have same characteristics as detection zones and require 6K8Ω EOL resistors to monitor circuit integrity, i.e. short circuit or open circuit faults. A 470Ω triggering resistor must be wired in series with the switch connected to the circuit as shown in the diagram below.

Figure 3-11
Monitored Input - Example Circuit

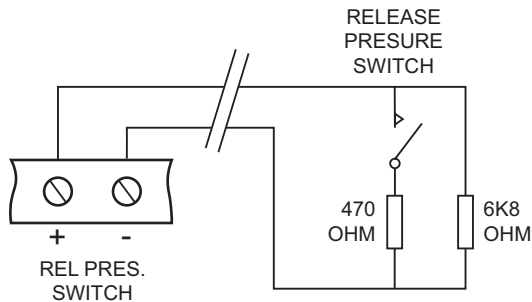

The following headings describe the functionality associated with each monitored input provided on the Sigma ZXT.

<p>HOLD (+/-)</p>	<p>For connection of external Hold switches, i.e. Kentec part ref. KB91000M10 and K91000M10. The HOLD input can be activated (by operation of an emergency hold device) during the 2nd stage imminent gas release countdown to halt the extinguishant release process. Activation of the input will stop the countdown timer, 2nd stage sounders will change to 1 sec ON and 2 sec s OFF pulsing, "Hold Operated" LED will illuminate, panel buzzer will sound and LCD will display the word 'HOLDING'. Any relay output configured to signal an active HOLD state will also operate.</p> <p>The HOLD input is a non-latching input which when de-activated will return to its normal state, "Hold Operated" LED will be off any HOLD relays will revert to normal state and the release process will be restarted with the countdown timer restarting from its original start value.</p> <p>If the HOLD input is activated with the panel in normal state or prior to a release countdown the "Hold Operated" LED will illuminate, the panel buzzer will sound and the LCD will display "HOLD is ACTIVE". If a 2nd stage countdown commences the release countdown will be stopped, the LCD will change to display "HOLDING" and the extinguishant release process will be halted.</p>
<p>ABORT (+/-)</p>	<p>For connection of external Abort switches i.e. Kentec part ref. K13470M1. The ABORT input can be activated (by operation of an emergency abort device) during the 2nd stage imminent gas release countdown to abort the extinguishant release process. Activation of the input will stop the countdown timer, "Abort Operated" LED will illuminate, panel buzzer will sound and LCD will display the word 'ACTIVATION ABORTED'. Any relay output configured to signal an active ABORT state will also operate. In the ACTIVATION ABORTED state the panel 2nd stage alarm condition can be cleared by resetting the control panel.</p> <p>The ABORT input is a latching input which when de-activated will not automatically clear the active ABORT state. An active ABORT state can only be cleared by resetting the control panel.</p> <p>If the ABORT input is activated with the panel in normal state or prior to a release countdown the ABORT LED will illuminate, the panel buzzer will sound and the LCD will display "ABORT operated". If a 2nd stage countdown commences the release countdown will be stopped, the LCD will change to display "ACTIVATION ABORTED" and the extinguishant release process will be aborted.</p>
<p>MAN RELEASE (+/-)</p>	<p>For connection of external Manual Release Call Points. Activation of this input (by operation of a remote manual release call-point) will manually trigger the extinguishing release process. The Control Panel will activate all indications, outputs and timers associated with a 2nd stage alarm followed by the release of extinguishant.</p>

<p>MODE (+/-)</p>	<p>For connection of remote Auto/Manual mode key-switches. Activation of this input will change the status of the extinguishing system from Auto to Manual mode. De-activation of the input will return the extinguishing system to Auto mode. The mode status is indicated by the "Auto" and "Manual" LEDs on the front fascia. If the Panel has already been placed in Manual Mode from another source i.e. Panel key-switch or Status indicator, operation of this input will have no effect.</p>
<p>REL PRES. SWITCH (+/-)</p>	<p>For connection of pressure switches used to confirm the release of extinguishant. Activation of this input will put the Control Panel into 2nd stage gas discharge confirmation state. All indications and outputs associated with 2nd stage discharge confirmation shall be activated, LCD will show "DISCHARGED". The input can be configured for use with either Normally Open (Normal) or Normally Closed (Inverted) pressure switches, see the Configuration section of this manual.</p>
<p>DIS EXTG (+/-)</p>	<p>Activation of the DIS EXTG (Disable Extinguishing) input disables the Extinguishant Release function of the Control Panel. Any alarms which are activated will be indicated as normal however no gas release will be instigated. This is a non-latching input when de-activated the extinguishing disablement will be automatically removed.</p> <p>The panel will indicate the disablement status by illuminating the "Flooding Zone Fault/Disabled", "Extinguishant Disablement" and "General Disablement" LEDs.</p>
<p>LOW PRES. SWITCH (+/-)</p>	<p>For connection of Pressure Switches used to monitor for low pressure within extinguishant cylinders. The input will be activated following a successful gas discharge or when the pressure within the gas cylinder drops below a set level indicating the presence of a leak. Activation of the input will illuminate the "Low Pressure" LED and will flash the "Flooding Zone Fault/Disabled" The input can be configured for use with either Normally Open (Normal) or Normally Closed (Inverted) Pressure Switches (see the Configuration section of this manual).</p>

Non-Monitored Inputs

P1 & P2 Prog I/P's

Two non-monitored programmable inputs are provided which can be used to monitor signals from other remote equipment or activate various control features remotely. The inputs are held high in their default state (3.3V) and must be pulled low (0V applied) to activate i.e. via a key-switch or remote relay contact. A 0V input terminal is provided next to the P1 & P2 terminals which can be used as the 0V trigger.

P1 & P2 can be configured to any of the following functions/states:

Evacuate	In this mode the input can be used to manually initiate an evacuation of the building/area. Activation of the input will operate sounder outputs S1 & S2. The LCD will turn a red colour (if dynamic) and displays the text "EVACUATE". This function is non-latching therefore sounders will only operate while the input is active, de-activation of the input will return sounder circuits S1 & S2 to their default state.
Silence Alarm	Activation of the input in this mode will silence active devices attached to sounder circuits S1 & S2. This function will not work if Sounders S1 & S2 are configured as non-silenceable.
Reset	Activation of the input in this mode will replicate the functionality of the reset button on the front of the panel.
General Fault	Activation of the input in this mode will trigger a general fault indication on the Control Panel. This can be used to signal the fault status of other devices connected to the control panel on the panel fascia i.e. The fault output of an aspirating unit connected to a detection zone. Activation of the input in this mode is for status indication only and will not affect the functionality of the panel.
Flooding Zone Fault	Activation of the input in this mode triggers a flooding zone fault indication on the control panel fascia. This can be used to provide status information relating to equipment connected to the panel which may be linked to the flooding zone. Activation of the input in this mode is for status indication only and will not affect the functionality of the panel.
General Disablement	Activation of the input in this mode will trigger a general disablement indication on the Control Panel. This can be used to signal the disabled status of detection devices which have their own disable function i.e. Aspirating systems can be disabled at the detector, a disabled output can be connected to this input to notify when an aspirating device connected to the panel is disabled. Activation of the input in this mode is for status indication only and will not affect the functionality of the panel.
Access Level 2	Activation of the input in this mode puts the Control Panel into Access Level 2. The Panel will remain at Access Level 2 only while the input is active.
Start Extraction	This options allows the input to be a trigger for manual activation of an extract fan. Activation of the input will operate any relay output which has been configure as an extract output. When activated the "Extract Fan On" LED will illuminate.
Use Reserve Extinguishing	This function will only be available when Sounder circuit S2 is configured as an extinguishing output and the Panel is configured for Main and Reserve cylinder setup. Activation of the input will transfer the extinguishing system to use the reserve set of cylinders should gas release be triggered.
Transparent	This mode allows the input to be used to monitor the status of non-essential equipment remote to the panel. A transparent event will not be displayed on the panel fascia but will be logged in the event log i.e. could be used to monitor open and closed state of access doors.

Output Circuits

The Sigma ZXT is provided with various monitored and non-monitored output circuits. This section provides details on functionality and wiring for each of the inputs provided.

Sounder circuits

Three fully monitored polarised conventional sounder circuits are provided on the Sigma ZXT, identified as S1, S2 and S3.

S1 and S2

These are common alarm sounder outputs providing notification of an active fire condition on any of the detection zones, notifying personnel of the need to evacuate the area. These sounders operate in compliance with EN54-2.

Sounder circuit S2 is a configurable output, in its default state it operates as a conventional sounder output in compliance with the requirements of EN54-2. However S2 can be programmed to operate as a second extinguishing output in compliance with EN12094-1. This provides support for extinguishing systems which require dual common extinguisher outputs or dual outputs for main and reserve cylinder systems.

Note: The functions and settings available for S2 will change depending on its configuration. No sounder settings are available for S2 when it is configured as an extinguishing output and vice versa.

Note: It is important if sounder output S2 has been reconfigured to be an extinguishing output that this is clearly identified within the panel.

To configure Sounder S2 as an extinguishing output follow the steps below:

1. Enter ENGINEERING MENU (Access Level 3) using password
2. Select "System settings" option
3. Scroll down to "Sounder 2 OP" option
4. Use left and right cursor keys to toggle to set the "Sounder 2 OP" to "Extinguisher".

If using S2 as an extinguishing output connection refer to the relevant installation and configuration sections of this manual.

S3

This is a 2nd stage alarm sounder which notifies personnel of an impending extinguishant release within the risk area. Operates in compliance with the requirements of EN12094-1

- The sounder output has multiple states to clearly indicate different stages of a gas release.
- Pulsing 1 sec on, 1 sec off indicates a 2nd stage alarm extinguishant release is imminent.
- Pulsing 1 sec on, 2 seconds off indicates an emergency hold device has been activated and release count down has stopped.

Continuous operation indicates that extinguishant has been released in to the protected area.

Sounder circuits are fully monitored utilising an end of line diode (IN4004).

Figure 3-12
Sounder Circuit Diagram

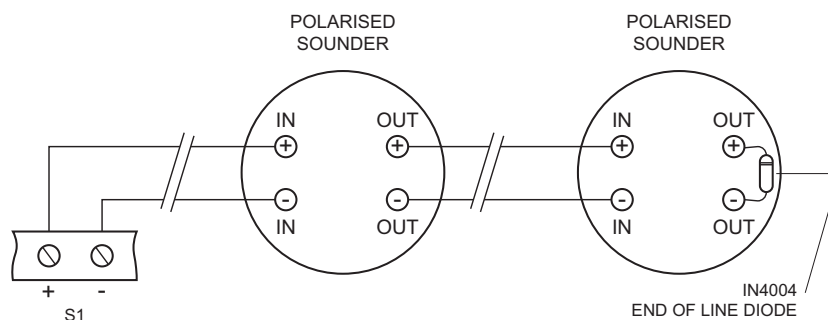

Each Sounder circuit has a maximum rating of 0.5 Amps. Sounder circuits must be wired as a single, radial circuit with no spurs or T-junctions to enable the monitoring circuit to work correctly. Configuration options are available for sounder circuits S1 & S2. These are detailed in the Configuration section of this manual.

Extinguishing Outputs

Sigma ZXT in its default configuration has one dedicated extinguishing output for activation of an extinguishing solenoid or igniting actuators. The output is rated at 1 Amp continuous operation or 3 Amps for a maximum of 50ms.

Sigma ZXT has the capability of providing a second extinguishing output supporting systems where dual extinguishing outputs are required. To provide the second extinguishing output it is necessary to reconfigure the functionality of sounder output S2, see configuration section of this manual. Configuring sounder output S2 as an extinguishing output will change the default functionality and the configuration settings associated with S2. S2 as an extinguishing output will be referred to in the configuration menu settings as EXT2, the primary extinguishing output is referred to as EXT1. The rating of EXT2 (S2) is the same as EXT1, 1 Amp continuous operation or 3 Amps for a maximum of 50ms.

Note: It is important if sounder output S2 has been reconfigured to be an extinguishing output that this is clearly identified within the control panel.

The wiring details for solenoids or actuators to extinguishing outputs EXT1 or EXT2 (S2) are shown in figs 3-13 & 3-14.

As different solenoids/actuators will have different resistances it is essential to calibrate the extinguishing outputs to ensure they are correctly monitored for open and short circuit fault conditions. The solenoid or actuators should be connected as shown in this manual and then select the CALIBRATE EXT1 and CALIBRATE EXT2 options as required in the access level 3 "ECD settings" menu.

Operating of Dual Extinguishing Outputs

If dual extinguishing outputs are being used they can be configured for two methods of operation either common or main/reserve. the operation of both is described as follows:

COMMON

Common dual extinguishing outputs are used where the activation of two solenoids is required to release a single set of extinguishing cylinders.

Each extinguishing output can have a configured release delay to enable them to operate both at the same time or at different times one after the other.

MAIN/RESERVE

This type of configuration is used for systems where two identical sets of cylinders are used to provide a back-up following a release.

EXT1 will be connected to the main set of extinguishing cylinders and EXT2 (S2) will be connected to the reserve set of cylinders. An activation of the extinguishing system will operate output EXT1 only. To return the system to a functional state the control panel (prior to main cylinders being refilled) can be manually changed to reserve mode whereby the system will use EXT2 and the reserve set of cylinders to continue functioning. This will allow the extinguishing system to continue protecting the risk area until the main cylinders are refilled.

To switch the panel between common and main/reserve extinguishing outputs follow the below steps:

1. Enter ENGINEERING MENU (Access Level 3) using password
2. Select "ECD settings" option
3. Scroll down to "Sounder 2" option
4. Use left and right cursor keys to toggle the setting between "Common Exting" and "Reserve Exting"

Solenoid Wiring

Solenoids used with the ZXT must have a resistance of greater than 28 Ohms to ensure that the maximum current rating of the extinguishant output is not exceeded. A suppression diode should be fitted across the solenoid to prevent back EMF generated by the solenoid when it de-energises from effecting the ZXT.

Figure 3-13
Solenoid Wiring Diagram

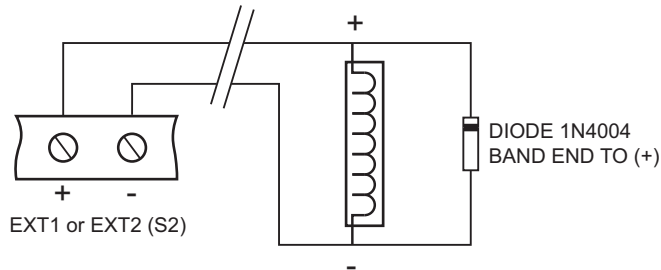

Note:
Check solenoid specification. Some polarised solenoids will already have a suppression diode fitted internally.

Igniting Actuator Wiring

A maximum of four igniting actuators can be wired in series.

If less than 3 igniting actuators are fitted, a 2R2Ω, 2.5W resistor must be wired in series to provide the correct monitoring resistance. The end of line diode can be discarded when igniting actuators are used.

Important! To ensure firing under all conditions, the total resistance of actuators, monitoring resistor and cable should not exceed 7 Ohms.

Figure 3-14
Igniting Actuator Wiring Diagram

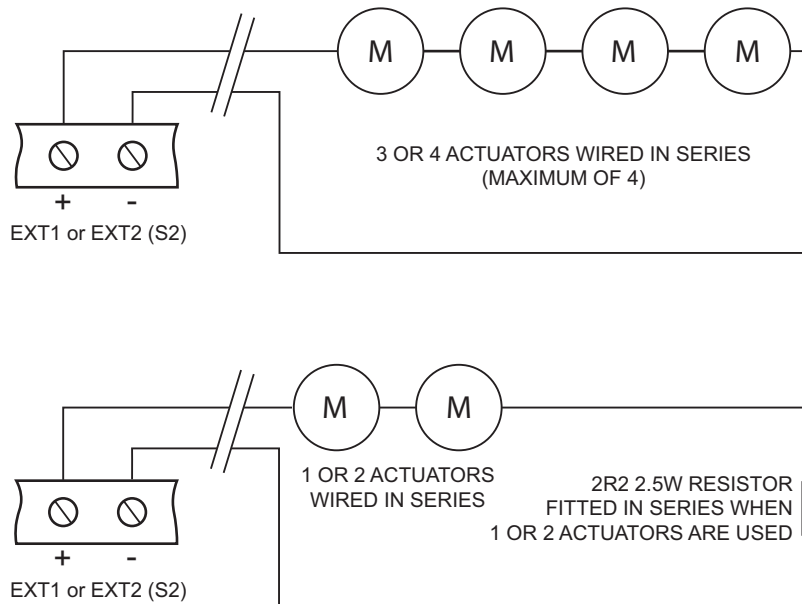

Relay Outputs

Six Volt Free Change Over (VFCO) Relay outputs are provided in the ZXT rated at 30V DC 1 Amp. The default identification and operation of these outputs are as follows:

- Fault
- Fire
- Released
- Mode
- Hold
- Abort

The operation of the relays can be re-configured to signal other status conditions, there are 15 programmable status conditions that the relays can be programmed for:.

Fire	Output will be normally open and switches to closed with an active fire event. Fire relays are non-silenceable i.e. Relay remains active when silence alarms is pressed and can only be cleared by a panel reset.
Alarm	Output will be normally open and switches to closed with an active zone alarm. Alarm relays are silenceable i.e. Relay will return to normal state when silence alarm button is pressed.
Fault	A fail-safe relay which is normally closed and will switch to open when a fault is active on the system.
Pre-Activated	Output will be normally open and switches to closed when a 1st stage alarm is active.
Activated	Output will be normally open and switches to closed when a 2nd stage alarm is active.
Released	Output will be normally open and switches to closed on confirmation of extinguishant release.
On Manual	Output will be normally open and switches to closed when extinguishing system is in Manual mode.
On Hold	Output will be normally open and switches to closed when the Hold input is active.
On Abort	Output will be normally open and switches to closed when the Abort input is active.
Low Pressure	Output will be normally open and switches to closed when the Low Pressure input is active.
Release Disabled	Output will be normally open and switches to closed when extinguishing release system is disabled.
On General Disablement	Output will be normally open and switches to closed when an active disablement exists on the panel.
Reset	Output will be normally open and switches to closed when the Reset button is pressed.
Extract	Output will be normally open and switches to closed when an extract input is activated. This output is used to activate an extract system.

See the Configuration section of this manual on how to programme relay outputs.

Relay operation can be programmed as required by the installer, however terminals within the control panel are identified by their default configuration. It is important if the configuration of the relay has changed from its default mode of operation that the terminals in the panel are clearly marked with the new mode of operation.

Important!

The default settings for relays ensure compliance to EN54-2 and EN12094 standards. Changing the functionality of the relay outputs will make the extinguishing system non-compliant with the above standards.

AUX 24V DC Supply

An auxiliary 24V DC (300mA) supply is provided to enable local signalling or control ancillary systems.

The auxiliary supply output is fitted with short circuit protection to prevent damage in the event of a wiring fault.

If the AUX 24V DC supply is used to power electromechanical devices such as relays or door retainers. It is imperative that a suppression diode be fitted across the coil of the device, to prevent the generation of high voltage transients back to the Control Panel power supply.

The AUX 24V DC can be programmed so that the supply is maintained upon a reset. (See Configuration section of this manual).

Important! Due to start-up current the Auxiliary Output can power no more than two status indicators.

RS485 Output

An RS485 output is provided on the Sigma ZXT to allow connection of Status Indicators and Ancillary PCB's.

The RS485 output will support a combination of up to 7 x Status Indicators (addresses 1-7) and 7 x Ancillary PCB's (addresses 1 - 7).

Section 4 Controls

Sigma ZXT combines LED status indications with a 128 x 64 pixel display to ensure status information is clear and concise.

Figure 4-1
Control Panel fascia

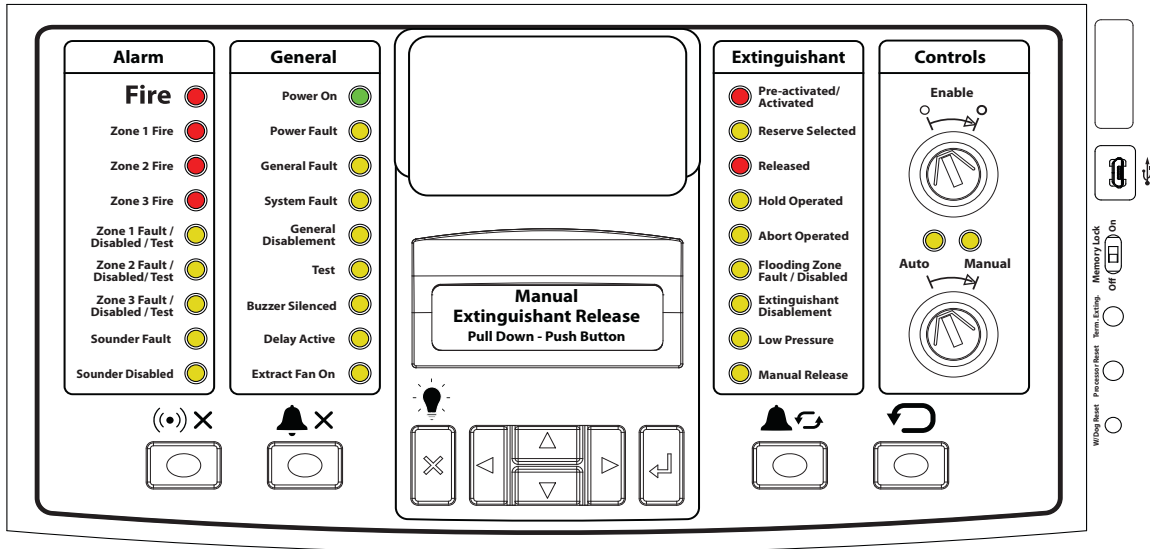

Control Panel Fascia

The Control Panel fascia is laid out in sections making it easier for the user to interpret the information displayed:

Alarm status

Provides all indications relating to alarm status as well as fault, disable and test status of detection and sounder circuits.

General status

Provides common status indications relating to the general Panel condition such as Power Fault, General Fault, System Fault etc.

Extinguishant status

Provides all indications relating to the status of the extinguishant control section of the ZXT covering activations, fault status and disablements.

LED Indications

LED indications are provided to indicate the status of the ZXT Control Panel. The LEDs are supplemented by the addition of an LCD which provides further detailed status information. LEDs provided and their function are described below.

Alarm Status Indications

Fire - Red LED indicating an active fire event on the Panel with multiple states:	
LED Status	Description
Flashing red (Accompanied by zone fire LED)	Indicates an unacknowledged zonal alarm and will be accompanied by the relevant zonal fire LED.
Steady red (Accompanied by zone fire LED)	Indicates an acknowledged zonal alarm, silence alarms has been pressed silencing 1st stage sounders (S1 & S2).

Zone Fire - Three Red LEDs indicate an alarm is active on a particular detection zone:	
LED Status	Description
Flashing red	Indicates an unacknowledged alarm condition in the identified zone.
Steady red	Indicates an acknowledged alarm condition in the identified zone ("Silence Alarm" pressed).

Zone Fault/Disabled/Test - An amber LED which is used to indicate multiple states of zone functionality:	
LED Status	Description
Flashing amber (accompanied by the General Fault LED)	Indicates an active fault condition on the indicated zone i.e. open circuit, short circuit, detector head removed.
Steady amber (accompanied by General Disablement LED)	Indicates the zone is disabled.
Steady amber (accompanied by the Test LED)	Indicates the indicated zone is in test mode.

Sounder Fault	
LED Status	Description
Flashing amber (accompanied by the General Fault LED)	Indicates an open or short circuit fault is active on one or more of the sounder circuits. In the event of such a fault the LCD will provide further detailed information on which sounder circuit is in fault and the nature of the fault i.e. Sounder 1 - Open circuit.

Sounder Disabled	
LED Status	Description
Steady amber (accompanied by the General Disablement LED)	Indicates that one or more of the sounder circuits have been disabled and are not functional. This is a single LED indicating a generic sounder disablement which is complemented by further detailed information on the LCD. LCD will indicate which sounder circuit(s) are disabled.

General Status Indications

Power On	
LED Status	Description
Steady green	Indicates that the panel is in the on state i.e. power is supplied to the panel.

Power Fault	
LED Status	Description
Flashing amber	Indicates a failure with the power supplied to the panel. LCD will provide detailed information on the power fault type i.e. Mains fail, Battery fail etc.

General Fault	
LED Status	Description
Flashing amber	Indicates an active fault is present on the panel, this will generally be accompanied by indication of a specific fault type LED i.e. Zone fault, Sounder fault etc. LCD will also provide additional fault information.

System Fault	
LED Status	Description
Flashing amber	Indicates one or more of the following internal faults: Configuration data fault (memory corrupt) Language data fault (memory corrupt)
Steady amber	CPU fault/watchdog time-out. Detailed information on the fault type will be provided on the LCD. Note: An active system fault will place the control panel into SAFE MODE. In SAFE MODE a panel cannot activate an extinguishing release. The message "Sys fault" (SAFE MODE) will be displayed on the LCD.

General Disablement	
LED Status	Description
Steady amber	Indicates an active disablement is present on the panel, this will generally be accompanied by indication of a specific disablement type LED i.e. Zone Disabled, Sounder Disabled etc. LCD will also provide additional disablement information.

Test	
LED Status	Description
Steady amber	Indicates that one or more detection zones are in test mode. It will be accompanied by the relevant zone test LED indicating steady amber. Test status will also be displayed on the LCD.

Buzzer Silenced	
LED Status	Description
Steady amber	Indicates that the panels buzzer has been silenced by pressing of the "Silence Buzzer" button. Silence buzzer function is only available during active alarm or fault events.

Delay Active	
LED Status	Description
Steady amber	Indicates that a programmed delay has been configured in relation to sounder S1 & S2 operation. The panel will indicate an alarm condition but will not operate the sounder outputs until the programmed delay time has elapsed.

Extract Fan On	
LED Status	Description
Steady amber	Illuminates when any output programmed as an extract output becomes active.

Extinguishing Status Indications

Pre-Activated/Activated	
LED Status	Description
Flashing red	Pre-Activated - Indicates that the extinguishing release is at 1 st stage.
Steady red	Activated - Indicates that the extinguishing release is at 2 nd stage with gas release imminent; i.e. multiple detection zones in alarm or manual release activated.

Reserve Selected	
LED Status	Description
Steady amber	If the extinguishing Panel has been configured to support a main and reserve extinguishing system this LED will illuminate when the Reserve system is selected.

Released	
LED Status	Description
Steady red	Illuminates when the release of extinguishant has been confirmed.

Hold Operated	
LED Status	Description
Steady amber	Illuminates when the Hold circuit has been activated.

Abort Operated	
LED Status	Description
Steady amber	Illuminates when the Abort circuit has been activated.

Flooding Zone Fault/Disabled	
LED Status	Description
Flashing amber	Indicates a fault on any of the following circuits: Abort, Hold, Manual Release, Mode, Released, Low pressure, RS485 comms, Sounder S3 and Sounder S2 if configured as an extinguishing output.
Steady amber	Indicates that any of the following circuits have been disabled: Abort, Hold, Manual Release, Mode, Released, Low Pressure, RS485 comms, Sounder S3 and Sounder S2 if configured as an extinguishing output. It will also illuminate if the "DIS EXT" input is active.

Extinguishant Disabled	
LED Status	Description
Steady amber	An amber LED indicating that the extinguishing function of the Panel has been disabled.

Low Pressure	
LED Status	Description
Steady amber	<p>Illuminates when the Pressure Switch connected to the input activates, indicates either of the following states:</p> <ul style="list-style-type: none">- Leak on the extinguishing cylinder causing a drop in cylinder pressure.- Cylinders empty following a successful discharge. <p>The Low Pressure LED will be accompanied by the Flooding Zone Fault LED.</p>

Manual Release	
LED Status	Description
Steady red	<p>Illuminates when the Manual Release circuit has been activated indicating a manual activation of the extinguishant release system. This is triggered by either the Manual Release button on the Panel fascia or status indicator or an Extinguishant Release Call Point connected to the Man Release input.</p>

Liquid Crystal Display (LCD) Indications

Sigma ZXT features a 128 x 64 pixel LCD providing 8 lines x 21 characters enabling further alarm and fault indication to be displayed.

The LCD has a 5 colour LED back-light which is used to provide easy visual status of access levels, fault or alarm conditions when set to Dynamic. This setting is found in Access Level 3 user settings and has two options “White” or “Dynamic”:

Dynamic Displays

The following figures show examples of LCD information for various states:

Figure 4-2

Normal Condition - Green

```

****SYSTEM STATUS****
JAN 01 2019 04:00:15*
(MANUAL & AUTO)

SYSTEM NORMAL

X EVENTS   CONTROLS↵

```

Figure 4-3

Access Level 2 - Turquoise

```

*****USER MENU*****
>VIEW ACTIVE EVENTS..
EVENT LOG FUNCTIONS..
TEST ZONES
ENABLE/DISABLE..
SOUNDER DELAY..
DATE AND TIME..
⏏ XBACK   GOTO MENU↵

```

Note: Access Level 2 screen will be turquoise if no faults or alarms are active. If active faults or alarms are present the screen will remain in the colour associated with the active event.

Figure 4-4

Access Level 3 - Blue

```

*****ENGINEER MENU*****
>CONNECTED DEVICES..
SYSTEM SETTINGS..
USER SETTINGS..
CIE ZONE SETTINGS..
ECD SETTINGS..
PROG I/P SETTINGS..
≡ XBACK   GOTO MENU↵

```

Note: Access Level 3 screen will be turquoise if no faults or alarms are active. If active faults or alarms are present the screen will remain in the colour associated with the active event.

Figure 4-5
Fault, Disabled or Test Condition – Yellow

```
TUE 01 JAN 2019 11:21:34
Z1          1 IN1
OPEN CIRUIT

≡ xEVENTS    CONTROLS ↓
```

```
*PANEL SOUNDERS DISABLE*
DISABLE ALL:NO
>SOUNDER1:DISABLED
SOUNDER2:ENABLED

≡          S1 DISABLED
```

```
*****SYSTEM STATUS*****
TUE 01 JAN 2019 11:00:15
(MANUAL & AUTO)
ZONE IN TEST:1

xEVENTS    CONTROLS ↓
```

Figure 4-6
Fire Condition

The screen will be red with details of which zone or circuit has triggered the fire condition:

```
TUE 01 JAN 2019 02:55:28
Z3 ALARM          1 IN1
ZONE 3

≡ xEVENTS    CONTROLS ↓
```

If an extinguishing release delay has been programmed the screen will flash red during the countdown process while displaying the countdown timer:

```
***EXTINGUISHER STATUS***
      2ND STAGE
  26S ACTIVATED !!
      S TO RELEASE

xEVENTS
```

Figure 4-7**Released condition**

Once the countdown timer has completed and the extinguishant has been released the screen will be steady red and will show the discharged confirmation message along with the duration timer counting down the time the extinguishing output remains active.

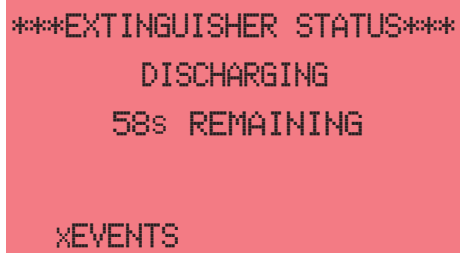
A rectangular LCD screen with a red background. The text is displayed in a monospaced, black font. The text is centered and reads: ***EXTINGUISHER STATUS***, DISCHARGING, 58s REMAINING, and XEVENTS.

```
***EXTINGUISHER STATUS***  
DISCHARGING  
58s REMAINING  
  
XEVENTS
```

Note: The contrast of the LCD can be adjusted through the “User Settings” menu – Access Level 3.

User Controls

Sigma ZXT user controls consist of an LCD navigation keypad, push buttons and key-switches.

LCD Navigation Push Button

The LCD Navigation Push Button Cluster enables the user to operate menu functions. Up and down can navigate the menus, left and right can be used to scroll through the various settings associated with a menu option. Push buttons either side perform other functions (described in the table below).

Figure 4-8
Navigation Push Button Cluster

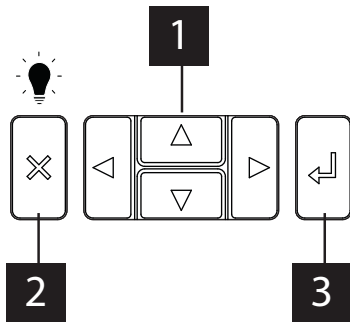

ID	Key	Function
1	Navigation push-button	Navigates LCD menu options up, down, left, right.
2	'X' push button (Lamp Test)	As primary function the 'X' button allows the user to go back screens. The 'X' will also perform other functions relating to corresponding LCD information. The 'X' button has a secondary function; when pressed it will test the fascia LED's by illuminating them simultaneously.
3	Enter push button	Enables selection of the required menu option and settings.

Silence Buzzer

An audible warning is provided at the Panel when various status conditions i.e. alarms, faults etc. Pressing the Silence Buzzer push-button will stop the buzzer sounding and illuminate the "Buzzer Silenced" LED.

Figure 4-9
Silence Buzzer Push-Button

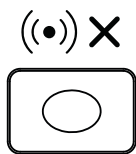

Silence Alarm

In an alarm condition the Sounder circuits S1 and S2 will be active and any audio/visual devices connected to these circuits will sound warning tones to notify occupants. Pressing the Silence Alarm push-button will cease the operation of the S1 and S2 Sounder circuits and the associated warning devices.

Figure 4-10
Silence Alarm Push-Button

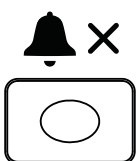

Note: Silence alarm function is only applicable to S1 and S2 sounder circuits. 2nd stage extinguishant release sounders (S3) cannot be silenced.

Alarm Re-sound

If Sounder circuits S1 and S2 alarms have been silenced pressing this push-button will re-activate them.

Figure 4-11
Alarm Re-Sound Button

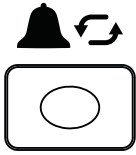

Note: If sounder circuit S2 is configured as an Extinguishing Output, this push-button will have no effect on the S2 output.

Reset

Pressing this push-button will clear any alarm or fault conditions, returning the Panel to its normal status, providing the alarm or fault condition is no longer active. If an alarm or fault is still active when the reset push-button is pushed, the Panel will return to the original alarm or fault state.

Figure 4-12
Reset Button

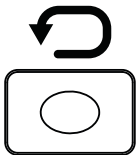

Note: Following extinguishant release, the Reset function can be inhibited for a pre-programmed time period, see Configuration section of this manual.

Important: Reset button will have no effect if countdown to release is in process.

Manual Release

Enables manual activation of the extinguishant release process.

Figure 4-13
Manual Release

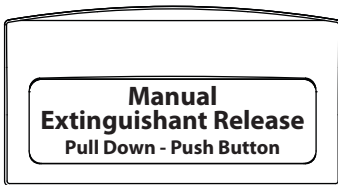

A yellow flap covers the Manual Release push-button to prevent accidental operation. To access the red push button, pull down the flap.

Figure 4-14
Manually Activating the Extinguishant Release Process

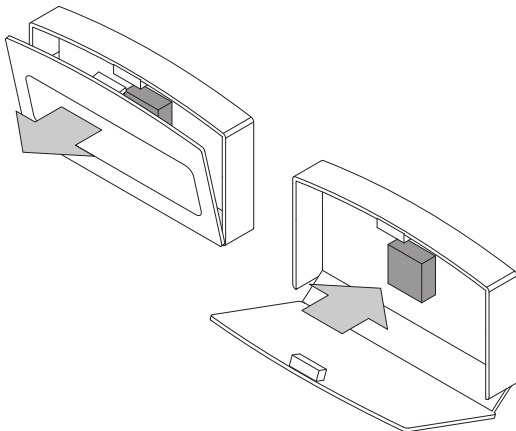

Control Key-Switches

Control key switches are located within the Controls section of the fascia. Control key-switches are operated using the keys supplied (901).

Figure 4-15
Control key-switches

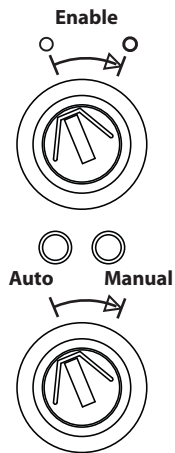

Enable Key-Switch

Two position access level key-switch. In the “Enable” position the Panel will enter Access Level 2 and display the Level 2 menu options on the LCD.

Auto/Manual Key-Switch

Two position key-switch which selects between “Auto” or “Manual” activation of the extinguishant release system. Two amber LED’s provide indication of the current state as well as notification on the LCD.

In “Auto” mode activation of the extinguishing release can be triggered by a combination of the automatic detection zones or by operation of the Manual Release Push Button or Manual Release Call Point.

In “Manual” mode the extinguishing release can only be triggered through manual intervention i.e. operation of a Manual Release Push Button on the Panel/status indicator unit or operation of a manual release call point. Automatic detection zone alarms will not activate the extinguishing release system when in manual mode.

Important! Switching between Auto and Manual modes can only be done using the same key-switch i.e. If manual mode is set using the control panel key-switch it can only be returned to auto using the same control panel key-switch, all other auto/manual key-switches on the system will be rendered non-functional.

Internal Indicators and Controls

Some internal controls and indications are provided on the ZXT which are only accessible to persons with a Panel door key. The following controls and indicators are located on the right-hand side of the Control Panel fascia in a vertical orientation.

Figure 4-16
Internal Indications and Controls

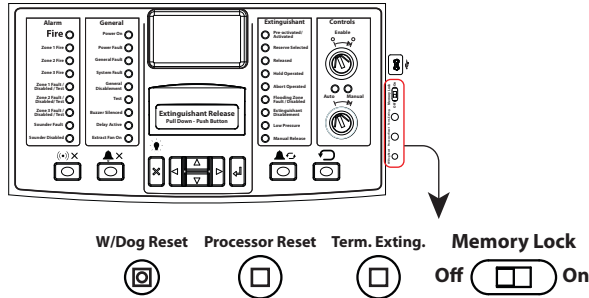

Watchdog Reset

This internal LED will illuminate when a failure occurs with the processor controlling the Panel.

If for any reason the microprocessor in the Panel fails to carry out its operation correctly, it will attempt to perform a self-reset. This process is called a “Watchdog” and the Control Panel must record and indicate these events.

When a watchdog event occurs, the Control Panel will show the “General Fault” and “System Fault” LEDs on the Panel fascia. A system fault can only be reset by pressing the internal “Processor Reset” button.

Processor Reset

The ZXT is designed to monitor the functionality of its internal processor and indicate any errors, these will be identified as a system fault on the Control Panel fascia. The Processor Reset push-button performs a reboot on the processor circuit to attempt to clear the associated issue.

Note: The push-button is inconspicuous and an instrument approximately 3mm in diameter (such as a small screwdriver) should be used to activate.

A processor reset should not normally be necessary but should be done as a matter of course if the system is behaving abnormally. The system should resume normal operation within a couple of seconds of pressing the Processor Reset button.

Term. Exting. (Terminate Extinguishing)

An extinguishing system can be programmed with a release duration time, this is how long the extinguishing output remains active once triggered. This button allows the user to stop an extinguishant release while it is in the discharging (release duration) stage.

Note: The push-button is inconspicuous and an instrument approximately 3mm in diameter (such as a small screwdriver) should be used to activate.

Memory Lock

This is a slide switch which enables and disables the ability to save and store Panel configuration changes made at Access Level 3 to the Panel’s memory.

In the ON position the Panel memory is locked which will prevent any configuration changes being saved to memory. In the OFF position the Panel memory will be unlocked allowing configuration changes to be saved.

ZXT has been designed so it can be used with the Kentec LE2 programming software, to upload and download configurations and event logs. To successfully achieve an upload or download this switch must be in the memory lock off position.

Mini USB Connector

This enables connection of a PC running LE2 configuration software. LE2 configuration software allows programming of panel settings as well as upload/download of config files and download of event logs.

Section 5
Panel Configuration

Configuration and interrogation of the Sigma ZXT is performed using the menu structure that appears on the LCD and user Control buttons on the Panel fascia.

Access Levels

Sigma ZXT has three access levels:

Access Level	Passcode
1	None
2	passcode1: 11111 passcode2: 22222 passcode3: 12121 passcode4: 44444 Enable keyswitch
3 (Engineering)	33333

Access Level 1

No Passcode required and no configuration options are available at Access Level 1. Access Level 1 is restricted to the viewing of Panel status and active events through the LED indications and LCD. The Lamp Test feature is also available at Access Level 1.

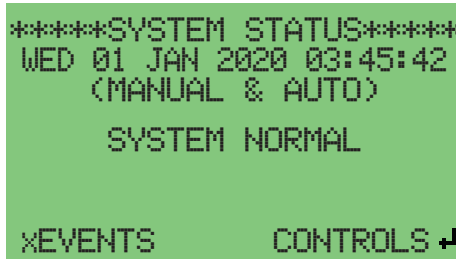

<p>ACTIVE EVENTS SUMMARY</p>	<p>Press the 'X' button on the fascia:</p>  <p>This screen shows a snapshot of how many active events exist on the Panel. These can be Alarms, Faults, Disablements or Other Events. The up and down arrow buttons can be used to scroll between the event types. When an active event type is highlighted, pressing the Enter button on the fascia will display further detail regarding the event(s).</p>
<p>Lamp Test (X)</p>	<p>The operation of the fascia LED indicators can be tested by pressing and holding the Lamp Test (X) button. Press and hold the button for at least 3 secs, all LEDs will illuminate, the panel buzzer will sound and the LCD will cycle between red, blue and green colour screens. Release the button to end the lamp test.</p>
<p>Enter button (↵)</p>	<p>In normal status the Enter button is identified by the text CONTROLS on LCD, pressing the button in this state displays the Passcode entry screen. In the active EVENTS SUMMARY SCREEN, the Enter button is identified with the text VIEW this allows active events to be selected and further status details to be displayed.</p>

Access Level 2

This level is accessed by entering the Passcode or by operation of the enable key-switch. To enter Access Level 2 by Passcode press the controls button and the Passcode Entry screen will appear.

**Figure 5-1
Passcode Entry Screen**

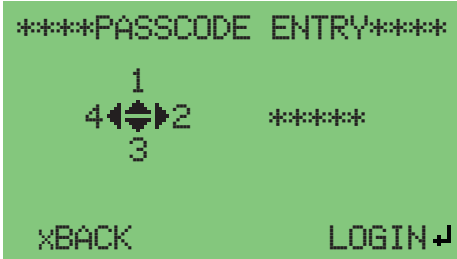

Four user passcodes are provided for access to level 2 which can be allocated to different users. The event log will provide a record which users have logged in and when.

Default passcodes for access level 2 are as follows:

- passcode1: 11111
- passcode2: 22222
- passcode3: 12121
- passcode4: 44444

The passcodes can be changed to suit using LE2 configuration software.

Level 2 enables access to the following user functionalities: Test, Disablement, Event log functions, Sounder delays, Date and Time and level 3 access.

VIEW ACTIVE EVENTS..	Selecting this option displays the ACTIVE EVENTS SUMMARY screen.
EVENT LOG FUNCTIONS..	<p>This option accesses the event log, selecting this option will initially show the text "Display on screen".</p> <p>The method of displaying events cannot be changed from DISPLAY ON SCREEN.</p> <p>Press enter to view the event log, two events will be shown on the screen at a time. The up/down arrow buttons can be used to scroll through the event log. The left/right arrows can be used to filter the event types you wish to view.</p> <p>Select the event type to be filtered shown at the top of the screen and press enter button.</p> <p>Event filter options are as follows:</p> <p>ALL EVENTS FIRES FAULTS DISABLEMENTS OTHER EVENTS</p> <p>The event log will store up to 999 events and once full will replace the oldest event with the newest. This screen also shows the alarm counter i.e. the number of alarms that have occurred on the panel.</p>

<p>TEST ZONES..</p>	<p>This option enables the user to put automatic detection zones into Test Mode during commissioning or system servicing, which prevents the system from triggering its cause and effect.</p> <p>Selecting this option displays the following sub menu:</p> <pre> *****TEST ZONES***** >SOUNDER: OFF ZONE 1: NORMAL ZONE 2: NORMAL ZONE 3: NORMAL xBACK CHANGE <=> </pre>
---------------------	--

<p>SOUNDER</p>	<p>This option enables the 1st stage sounders S1 and S2 to be turned off while in test mode allowing an engineer to put the test zone into alarm without triggering the Panel Sounder circuits. The option is either ON or OFF; ON will trigger the Sounder outputs when the zone under test is put into alarm; OFF will prevent the Sounder outputs from operating when the zone under test is put into alarm.</p>
<p>ZONE 'n'</p>	<p>Three detection zones are provided and any of these zones can be placed into test mode. Use the up/down buttons to select the zone to put into test and then use the left/right buttons to toggle between NORMAL and IN TEST.</p> <p>When a detection zone is placed into test the LCD will display the test status while the general test and relevant zone test LEDs illuminate on the Panel fascia.</p> <p>The main screen will display the zone(s) in test:</p> <pre> *****TEST ZONES***** SOUNDER: OFF >ZONE 1: IN TEST ZONE 2: NORMAL ZONE 3: NORMAL xBACK CHANGE <=> </pre> <p>Once testing has been completed the zone should be returned to the NORMAL setting.</p>
<p>ENABLE/DISABLE..</p>	<p>This menu option opens the ENABLE/DISABLE menu allowing the user to enable and disable various functions on the panel.. Disablement of a function prevents it from operating this can be used during maintenance or servicing periods preventing the risk of accidentally triggering the system.</p> <p>If configured as a dynamic display the LCD will turn yellow when an active disablement exists.</p>
<p>CIE ZONES..</p>	<p>This sub-menu allows the enablement and disablement of automatic detection zones. The zone to be disabled should be highlighted using the up/down cursor. When the relevant detection zone is highlighted the left/right buttons can be used to toggle between the enabled and disabled states.</p> <p>When a detection zone is disabled the "General Disablement" LED and relevant zone disabled LED indicators illuminate. Details of the disablement event can be viewed on the LCD.</p>

<p>ECD SUBSYSTEM..</p>	<p>The number of options available in this menu will vary dependent on other configuration settings. Two options will always be present EXTING RELEASE and ALL MAN RELEASE, a third menu option EXTRACTOR will be visible if the panel has an output configured to switch on an extract fan:</p> <pre> **ECD SUBSYS DISABLE** >EXTING RELEASE:ENABLED EXTRACTOR:ENABLED ALL MAN RELEASE:ENABLED XBACK CHANGE ◀▶ </pre> <p>EXTING RELEASE This feature enables or disables the extinguishing output function, while in "DISABLED" mode the Panel will not activate the extinguishing output. Alarm actions will follow the normal sequence, activating sounders etc. but will not operate the extinguishing output (EXTING.). The menu option can be toggled between Enable/Disable state using the left/right buttons. When extinguishing release is disabled the Extinguishant Disablement, Flooding Zone Fault/Disabled and General Disablement LEDs will be illuminated. Any relay outputs configured for "Release Disabled" or "On General Disablement" will also operate. LCD will provide additional info on active.</p> <p>Note: The Disable Exting Release function will not be available if a 2nd stage alarm release imminent state is active.</p> <p>EXTRACTOR This feature enables or disables any output that has been configured as an extract output. The menu option can be toggled between Enable/Disable states using the left/right buttons. When the option is disabled the "General Disablement" LED will illuminate and any relay output programmed as "On General Disablement" will operate.</p> <p>ALL MAN RELEASE Disables all manual release push-buttons and inputs. This prevents the panel from being activated by a Manual Release push-button on the Control Panel or Status Indicator, also prevents activation from a manual release input. When disabled the "General Disablement" and "Flooding Zone Fault/Disabled" LED will be illuminated. Any relay programmed as "On General Disablement" will operate. Additional info on active disablements will be provided on the LCD.</p>
<p>SOUNDERS..</p>	<p>This function allows the enablement and disablement of the 1st stage Sounder circuits S1 and S2. Sounders can be enabled or disabled individually or as a group as shown in the screen shot below:</p> <pre> **PANEL SOUNDERS DISABLE** >DISABLE ALL:NO SOUNDER1:ENABLED SOUNDER2:ENABLED XBACK CHANGE ◀▶ </pre> <p>The status of each of the listed menu options can be toggled between enable/disable states using the left/right buttons.</p> <p>Disablement of the Sounders will prevent the Sounder circuits from activating in an alarm condition. When set to DISABLED the GENERAL DISABLEMENT and the "Sounder Disabled" LED indicator will be illuminated, specific details of which sounder circuits are disabled are displayed at the bottom of the LCD.</p> <p>Note: Sounder circuit S2 will not appear in this list if it has been programmed as an extinguishing output.</p> <p>Note: To comply with the requirements of EN12094-1 2nd stage sounders S3 cannot be disabled unless the extinguishing system is also disabled. Therefore the option to disable Sounder 3 (S3) will only appear in this menu when the extinguishing system is disabled.</p>

<p>RELAYS..</p>	<p>This menu allows enablement and disablement of any of the relay outputs provided on the Control Panel. A disabled relay output will not activate even if the state it relates to is active. The screen shot shows the menu feature and the relays available:</p> <pre> ***PANEL RELAYS DISABLE*** >FIRE RELAY:ENABLED FAULT RELAY:ENABLED RELEASE RELAY:ENABLED MODE RELAY:ENABLED HOLD RELAY:ENABLED ABORT RELAY:ENABLED XBACK CHANGE ◀▶ </pre> <p>The status of each of the listed menu options can be toggled between ENABLE/DISABLED using the left/right buttons. When set to DISABLED the “General Disablement” LED will illuminate and any output configured as “On General Disablement” will operate. Additional info on active disablements is available on the LCD.</p> <p>Important! The relay descriptions in this menu are based on the default relay descriptions.</p>
<p>MONITORED INPUTS..</p>	<p>This menu feature allows enablement and disablement of the monitored inputs. A disabled monitored input will not activate the associated event on the Panel even if a trigger device attached to that input is active. The screen-shot shows the menu feature and the inputs available:</p> <pre> MONITORED IP DISABLEMENTS >HOLD:ENABLED ABORT:ENABLED MAN MODE:ENABLED REL PR SW:ENABLED LO PR SW:ENABLED EXT REL IP:ENABLED XBACK CHANGE ◀▶ </pre> <p>The status of each of the listed menu options can be toggled between ENABLED/DISABLED using the left/right buttons. Monitored inputs are associated with the extinguishing release system therefore, when any of the inputs are disabled the “General Disablement” LED will illuminate along with the “Flooding Zone Fault/Disabled” LED. Any relay output configured as On General Disablement will also operate. Additional information on active disablements can be viewed on the LCD.</p>
<p>PANEL INPUTS..</p>	<p>This menu feature allows enablement and disablement of the two programmable Panel inputs. A disabled input will not activate the associated event on the Panel even if a trigger device attached to that input is active. The screen-shot shows the menu feature and the inputs available:</p> <pre> ***PANEL IP DISABLEMENTS*** >PROG IP1:ENABLED PROG IP2:ENABLED XBACK CHANGE ◀▶ </pre> <p>The status of each of the listed menu options can be toggled between enable/disable states using the left/right buttons. When an input is disabled the “General Disablement” LED will illuminate and any relay output programmed as “On General Disablement” will operate. Additional information relating to active disablements can be viewed on the LCD.</p>

<p>SOUNDER DELAY..</p>	<p>This menu feature can be used to enable a delay in the operation of 1st stage Sounder circuits S1 and S2.</p> <p>Note: If S2 is configured as an extinguishant output no delay option will be available for the output in this menu.</p> <pre>*****SOUNDER DELAYS***** >SOUNDER 1:IMMEDIATE SOUNDER 2:IMMEDIATE XBACK CHANGE [right arrow]</pre> <p>The configured setting of the Sounder outputs can be toggled between IMMEDIATE and DELAYED. If the outputs are configured for immediate, outputs will operate as soon as a zonal alarm becomes active. If the outputs are configured as delayed the Sounders will only operate after a programmed delay period.</p> <p>Configuration of the delay period can only be carried out at Access Level 3 CIE ZONE SETTINGS menu option.</p> <p>If delays have been configured this will be indicated by the "Delay Active" LED on the panel fascia.</p>
<p>DATE AND TIME..</p>	<p>This menu feature enables the setting of the Panels time and date. It is important to ensure the time and date is accurate for logging of events as this is significant for diagnostics.</p> <pre>*****DATE AND TIME***** >YEAR: 20 MONTH: 1 DAY: 1 HOUR: 1 MIN: 57 XBACK CHANGE [right arrow]</pre> <p>The menu allows setting of Day, Month, Year, Hour and Minutes; the value associated with each setting can be changed using the left/right buttons. Once settings have been updated, press the enter button to accept the changes.</p>
<p>EXTRACTOR FAN..</p>	<p>This menu option will only be available if one of the panels relay outputs has been programmed as an extract output used to control an extractor fan/system.</p> <p>The extractor fan option gives the user manual control over the activation and de-activation of an extract output.</p> <p>Left/right buttons can be used to turn the extractor fan on or off.</p> <p>If turned on the LCD will display the duration timer counting down. When the countdown timer is complete the extract output will be turned off.</p> <p>If manually turned off the countdown timer will disappear.</p>
<p>ENGINEERING MENU..</p>	<p>Opens the Passcode login screen enabling the user to enter the Engineering Menu (access level 3) Passcode.</p>

Access Level 3 (Engineering)

Level 3 can be accessed through Level 1 passcode entry screen directly, or Level 2 > Engineering Menu option (passcode required).

Figure 5-2
Access Level 3 Login Options



Access Level 3 default Passcode is '33333'

Each LCD Navigation button on the fascia panel represents a number with the **down** arrow representing the number 3.

If the LCD display is configured as 'dynamic' it will turn blue in Access Level 3.

Important! Level 3 menu enables full configuration of panel features, it is important to ensure if configuration changes are made in Access Level 3 that the **Memory Lock Switch** must be in the OFF position to enable them to be saved. Any configuration changes made while the Memory Lock switch is in the ON position will not be saved.

The following section addresses each of the menu options available.

<p>CONNECTED DEVICES..</p>	<p>This menu relates to ancillary items that can be attached to the Panel such as Status Indicators and expansion PCBs.</p> <p>The ZXT provides an RS485 bus for connection of status indicators and ancillary PCBs.</p> 
<p>REMOTE BUS..</p>	<p>This menu option provides a visual indication of what devices (status indicators/Ancillary PCBs) are connected to the Remote Bus and on which addresses. Devices must be logged onto the panel to be able to monitor them correctly and the display will identify units which are connected but not logged. The screen also provides the ability to install and remove devices from the system to prevent monitoring faults.</p> <p>For detailed information on connection installation of status indicators and ancillary boards to the ZXT, see Section 6.</p>

SYSTEM SETTINGS..	This menu contains configuration options relating to general system settings.
SUPPRESS FIRE RLY	<p>This option suppresses the operation of any relay output configured as a fire relay. The option can be toggled between YES and NO settings using the left/right buttons. If the fire relay is suppressed it will not operate during any fire alarm conditions.</p> <p>Important! If the fire relay is suppressed this is not indicated on the fire alarm panel.</p> <p>Warning! This option will prevent the panel from signalling a fire condition remotely and should be used with extreme caution. Suppressing the fire relay does not comply with the requirements of EN54-2.</p> <p>Default: NO</p>
SUPPRESS FAULT RLY	<p>This option suppresses the operation of any relay output configured as a fault relay. The option can be toggled between YES and NO settings using the left/right buttons. If the fault relay is suppressed it will not operate during any fault conditions.</p> <p>Important! If the fault relay is suppressed this is not indicated on the fire alarm panel.</p> <p>Warning! This option will prevent the panel from signalling a fault condition remotely and should be used with extreme caution. Suppressing the fault relay does not comply with the requirements of EN54-2.</p> <p>Default: NO</p>
NEW FAULT RLY TOGGLE	<p>This option configures the operation of the fault relay when multiple faults appear on the system. Fault relays are generally one shot and no matter how many faults appear the fault relay will only operate on the first fault condition.</p> <p>This feature if configured will allow the fault relay to indicate the activation of a new fault condition by toggling the relay off and then on again.</p> <p>The option setting can be configured between YES and NO using the left/right arrow keys.</p> <p>Default: NO</p>
MAINS FLT RLY DLY	<p>This option applies a delay to the operation of the fault relay when activated by a mains fault.</p> <p>For sites that have a generator back-up electricity supply, the delay in activating the Fault Relay on a mains fault will compensate for the period of time between the mains input failing and the generator supply activating. This prevents an unnecessary fault being indicated during the switch-over. The left/right buttons are used to change the setting value between OFF and 30m (30m = 30 minutes).</p> <p>If this option is activated and the back-up supply does not start after 30m the fault relay will activate. During this period the Panel will have a sufficient back-up battery supply to continue running.</p> <p>Important! Compliance to EN54-2 requires this option to be set to OFF.</p> <p>Default: OFF</p>
DETECT EARTH FAULTS	<p>This configuration can be used to turn on or off the earth fault monitoring function. Earth faults can have a significant effect on the operation of the Panel if undetected.</p> <p>It is recommended that this function should remain enabled at all times and should only be disabled as part of diagnostic investigations. The setting can be toggled between YES and NO by using the left/right buttons.</p> <p>Important! Compliance to EN54-2 requires this option to be set to YES.</p> <p>Default: YES</p>

<p>SOUNDER2 OP</p>	<p>This option relates to Sounder circuit S2 which can be configured as a second extinguishing output. Using the left/right buttons the option setting can be toggled between SOUNDER and EXTINGUISHER.</p> <p>If set to SOUNDER output S2 will operate as a 1st stage Sounder output in conjunction with output S1. If this option is set to EXTINGUISHER output S2 will operate as a second extinguishing output.</p> <p>Note: When S2 is configured as an extinguishing output it will be referenced as EXT2 in the ECD settings menu.</p> <p>Default: SOUNDER</p>
<p>AUX24V RESETS</p>	<p>This option configures the ability to drop the AUX 24V output voltage when the reset button is pressed on the Panel fascia. The left/right buttons are used to toggle between NONE and 3s.</p> <p>If set to "None" a reset will have no effect on the AUX 24V output. If set to 3s when a reset is performed the AUX 24V output will be dropped to 0V for 3 seconds, this can act as a reset signal for devices which are connected to the AUX 24V and require a power cycle to reset.</p> <p>Default: NONE</p>
<p>INVERT LOW PRESS SW</p>	<p>The Low Pressure Switch input is configured as default to monitor for a Normally Open pressure switch which closes on activation. This menu option enables the operation of the Low Pressure Switch to be inverted for systems which use Normally Closed pressure switches which open on activation.</p> <p>The option can be toggled between YES and NO determining whether the input operation is inverted or not.</p> <p>Warning! Changing the input state should never be carried out on a live system as this may trigger an unwanted activation.</p> <p>Default: NO</p>
<p>INVERT REL PRESS SW</p>	<p>The Release Pressure Switch input is configured as default to monitor for a Normally Open pressure switch which closes on activation. This menu option enables the operation of the Release Pressure Switch to be inverted for systems which use Normally Closed pressure switches which open on activation.</p> <p>The option can be toggled between YES and NO determining whether the input operation is inverted or not.</p> <p>Warning! Changing the input state should never be carried out on a live system as this may trigger an unwanted activation.</p> <p>Default: NO</p>
<p>RESET ECD</p>	<p>This option relates to the Reset push-button and allows the configuration of the reset action to be changed. The setting can be toggled between WITH CIE and AFTER CIE.</p> <p>If the option is set to WITH CIE the detection (CIE) and extinguishing (ECD) sections will reset simultaneously when the Reset push-button is pressed.</p> <p>If the option is set to AFTER CIE, when a reset is performed the detection (CIE) section of the panel will be reset but the extinguishing control part of the panel (ECD) will remain active. A second reset will be required to reset the extinguishing part of the panel (ECD).</p> <p>Default: WITH CIE</p>
<p>EN54-13 MONITORING..</p>	<p>This option turns on or off the facility of the panel to monitor its inputs in compliance with the requirements of EN54-13 for weak open and short circuits.</p> <p>Currently this function is not active within the panel, the panel will monitor its inputs as required for open and short circuits but not to the requirements of EN54-13.</p> <p>The setting of this feature has no effect at this time and will be implemented at a later date.</p>
<p>FIRMWARE..</p>	<p>Selecting this option displays the firmware screen. The screen displays the current firmware version, it also shows the checksum associated with that firmware.</p>

USER SETTINGS..	This menu contains configuration options associated with the general user set-up of the Panel. Details of the options in this menu are as follows:
LCD BACKLIGHT	<p>The LCD can be configured as either "DYNAMIC" or "WHITE". If the dynamic option is selected the LCD will change colour depending on the active state of the Panel ie:</p> <p>Normal: Green Access Level 2: Turquoise Access Level 3: Blue Fault: Yellow Test: Yellow Disablement: Yellow Fire: Red Release countdown: Flashing red Released: Red</p> <p>If the option is set to "WHITE" the LCD will not change colour regardless of Panel state.</p> <p>Default: DYNAMIC</p>
LCD CONTRAST	<p>This option allows the adjustment of the LCD contrast. Using the left/right buttons the value can be set between 0-10, 0 is the lightest contrast and 10 is the darkest.</p> <p>Default: 5</p>
ACCESS LEVEL BEEP	<p>This feature provides the facility to have an audible indication of the access level. If the option is OFF no audible indication is provided, if the option is ON audible indications are as follows:</p> <p>Access level 1 -No beep Access level 2 - 2 beeps approx every 5 secs Access level 3 - 3 beeps approx every 5 secs</p> <p>The option setting can be toggled between ON and OFF using the left/right buttons.</p> <p>Default: OFF</p>
BUZZER SIL LEVEL	<p>This option selects the access level at which the Silence Buzzer button can be used. The left/right buttons can be used to toggle the associated value between 1 and 2, if 1 is selected the Silence Buzzer button can be operated at level 1.</p> <p>If the value is set to 2 the Panel will need to be in Access Level 2 before the Silence Buzzer button can be used.</p> <p>Default: 1</p>
SUPPRESS BUZZER	<p>This option suppresses the operation of the panel buzzer. Using the left/right buttons the function can be toggled between YES and NO.</p> <p>If set to NO the panel buzzer will provide audible indications for fire and fault status.</p> <p>If set to YES the buzzer will no longer function, regardless of panel state. No indications are provided of the buzzer state.</p> <p>Default: NO To comply with EN54-2 requirements, this option must be set to NO.</p> <p>Warning! This option will prevent the panel from providing a local audible status indication and should be used with extreme caution. Suppressing the panel buzzer does not comply with the requirements of EN54-2.</p>
DAYLIGHT SAVING	<p>This option configures how the Panel handles time changes relating to daylight saving. Using the left/right buttons the option value can be toggled between "AUTO" and "OFF".</p> <p>If configured to "AUTO" the Panel will automatically adjust its time setting in line with daylight saving changes. If set to "OFF" the Panel will require manual adjustment of its time setting when daylight saving changes are required.</p> <p>Default: AUTO</p>

<p>DLS start month</p>	<p>This allows the user to set the month when daylight saving starts. This is to support daylight saving in different countries.</p> <p>Default: Mar</p>
<p>DLS start week</p>	<p>This allows the user to set the week of the month when daylight saving starts - 1st, 2nd,3rd, 4th or last. This is to support daylight saving in different countries.</p> <p>Default: Last</p>
<p>DLS end month</p>	<p>This allows the user to set the month when daylight saving ends. This is to support daylight saving in different countries.</p> <p>Default: Oct</p>
<p>DLS end week</p>	<p>This allows the user to set the week of the month when daylight saving ends - 1st, 2nd,3rd, 4th or last. This is to support daylight saving in different countries.</p> <p>Default: Last</p>
<p>LANGUAGE</p>	<p>ZXT panels are provided with two language options, which are English and Local. Local language relates to the alternative language translation provided in the panel i.e. German, French etc. The Local language will be specified at time of order.</p> <p>Left/right buttons can be used to select between English and Local options.</p>

CIE ZONE SETTINGS..	<p>This menu provides all the configuration options associated with CIE (Control and Indicating equipment) detection zones.</p> <p>The detection zones are individually configurable however the configuration settings for each zone are identical.</p>
CONFIGURE ZONE 'n'	<p>This first line is the user description text, press enter or right buttons to enter edit mode and the first letter will be highlighted.</p> <p>Use the up/down buttons to change the highlighted character and use the left/right buttons to move to the next character to change. 22 characters of description text can be added for each zone.</p>
DELAY SOUNDER 1 & 2	<p>This option enables a delay value to be set for Sounder circuits 1 and 2 in relation to the selected zone.</p> <p>The delay will only be active when the related zone goes into alarm. A delay can be set between 0 and 10 minutes in 30 sec increments. To set the value use the left/right buttons. This option also requires the Sounder delay setting (Access Level 2) to be set to "DELAYED".</p> <p>Note: The delay will not be applicable to circuit S2 when it is configured as an extinguishing output.</p> <p>Default: 0s</p>
LATCHING	<p>Zones 1 and 2 are non-configurable for this setting and are locked as latched. Zone 3 can be configured as latching or non-latching.</p> <p>Non-latching zones will automatically clear to their normal state once an active fault or alarm has been removed. Latching zones will remain in alarm or fault condition even if the cause of the condition has been rectified, and can only be cleared by performing a Panel reset.</p> <p>The left/right buttons toggle the setting between YES and NO.</p> <p>Important! Compliance to EN54-2 requires this option to be set to YES.</p> <p>Default: YES</p>
SOUNDERS	<p>This option controls the operation of sounder circuits S1 & S2 when an alarm is activated on a detection zone.</p> <p>The sounders can be set for "NORMAL" or "SILENT" operation using the left/right buttons to toggle the setting.</p> <p>NORMAL - Sounders will activate as required when the zone is in alarm.</p> <p>SILENT - In silent mode the panel will indicate the alarm condition and will operate any alarm relay outputs but will not activate the sounder outputs S1 & S2.</p> <p>Note: This function will not be applicable to circuit S2 when it is configured as an extinguishing output.</p> <p>Default: NORMAL</p>
SHORT CCT	<p>This option configures the zone to trigger either a fault or an alarm condition when a short circuit occurs on the zone.</p> <p>The left/right buttons toggle the setting between "FAULT" and "FIRE".</p> <p>Important! Compliance to EN54-2 requires this option to be set to FAULT.</p> <p>Warning! Short circuit triggering of an alarm condition does not comply to EN54-2 and should be used with extreme caution.</p> <p>Default: FAULT</p>
VERIFY DELAY	<p>This option configures a verification delay on the zone. A verification delay will wait for a programmed period of time before it activates the alarm condition, this ensures this is a constant alarm and not a spurious signal.</p> <p>The left/right buttons can be used to adjust the setting, this can be OFF or can be set between 5 and 30 secs in 5 sec increments.</p> <p>Default: OFF</p>

<p>I.S. BARRIER</p>	<p>This option configures the zone for use with intrinsically safe detection devices. To use intrinsically safe detection devices the circuit must be fitted with a suitable safety barrier which impacts the open and short circuit monitoring of the zone.</p> <p>By setting this option to “YES it will adjust the monitoring capabilities of the circuit to accommodate for the barrier.</p> <p>The left/right buttons toggle the setting between “YES” and “NO”</p> <p>Default: NO</p>
<p>ECD SETTINGS..</p>	<p>The ECD settings menu contains configuration relating to the extinguishing control device which controls and monitors the extinguishing release function of the Control Panel.</p>
<p>ACTIVATE ON</p>	<p>This option configures the zone activations required to trigger the gas release only, there are nine selectable combinations:</p> <p>Z1 ONLY This will trigger the gas release sequence when an alarm is active on detection zone 1 only.</p> <p>Z2 ONLY This will trigger the gas release sequence when an alarm is active on detection zone 2 only.</p> <p>Z3 ONLY This will trigger the gas release sequence when an alarm is active on detection zone 3 only.</p> <p>ANY 1 This will trigger the gas release sequence when any single detection zone alarm has an active alarm.</p> <p>Z1 & Z2 This setting provides coincidence detection, an alarm must be active on both detection zones 1 and 2 to initiate the extinguishing release sequence.</p> <p>Z1 & Z3 This setting provides coincidence detection, an alarm must be active on both detection zones 1 and 3 to initiate the extinguishing release sequence.</p> <p>Z2 & Z3 This setting provides coincidence detection, an alarm must be active on both detection zones 2 and 3 to initiate the extinguishing release sequence.</p> <p>ANY 2 This setting provides coincidence detection, an alarm must be active on any two of the three detection zones provided to initiate the extinguishing release sequence.</p> <p>ALL 3 This setting provides coincidence detection, an alarm must be active on all three detection zones 1 to initiate the extinguishing release sequence.</p> <p>Default: Z1 & Z2</p>
<p>HOLD FAULT</p>	<p>This option configures the operation of the hold input circuit in a fault condition.</p> <p>The left/right buttons will toggle the setting between “HOLDS ALSO” and “FAULT ONLY”.</p> <p>HOLDS ALSO If a fault exists on the hold input circuit the Panel will indicate a fault condition but will also activate the hold condition preventing the possibility of an extinguishing release.</p> <p>FAULT ONLY If a fault exists on the hold input circuit the Panel will indicate a fault condition only. The extinguishing system will continue to operate as normal.</p> <p>Important! Compliance to EN12094-1 requires this option to be set to HOLDS ALSO.</p> <p>Default: HOLDS ALSO</p>

<p>ABORT FAULT</p>	<p>This option configures the operation of the abort input circuit in a fault condition.</p> <p>The left/right buttons will toggle the setting between “ABORTS ALSO” and “FAULT ONLY”.</p> <p>ABORTS ALSO If a fault exists on the Abort Input circuit the Panel will indicate a fault condition but will also activate the abort condition preventing the possibility of an extinguishing release.</p> <p>FAULTS ONLY If a fault exists on the Hold Input circuit the Panel will indicate a fault condition only. The extinguishing system will continue to operate as normal.</p> <p>Important! Compliance to EN54-2 requires this option to be set to ABORTS ALSO.</p> <p>Default: ABORTS ALSO</p>
<p>REL LIT BY</p>	<p>This option controls the activation of the “Released” confirmation LED and when it illuminates.</p> <p>The left/right buttons will toggle the setting between “SW or EXT OP” and “REL SW ONLY”.</p> <p>SW or EXT OP The released LED will illuminate either on activation of the released pressure switch input or for systems with no release pressure switch it will operate when the extinguishing output is activated.</p> <p>REL SW ONLY If selected, the released LED will only illuminate if the Released Pressure switch input is activated.</p> <p>Default: SW or EXT OP</p>
<p>RESET INHIBIT</p>	<p>Following an extinguishing release it is possible to prevent the Control Panel from being reset for a programmed period of time. This option configures the period of time by which the reset function will be inhibited.</p> <p>The left/right buttons are used to change the setting value from 0 to 30m in 1 minute increments.</p> <p>Default: 1m</p>
<p>Note: If S2 is configured as a sounder output and the extinguishing system is configured for common operation of the extinguishing outputs, it is possible to configure independent extinguishing delays for the S2 extinguishing output. The delay settings listed below will be duplicated and will be identified with the suffix EXT 1 for the main extinguishing output and EXT 2 for the S2 Extinguishing output.</p>	
<p>RELEASE DELAY MAN</p>	<p>This option configures the delay period between a release activation and operation of the extinguishing output i.e. countdown to gas release when triggered by a manual release device.</p> <p>The delay is configurable between 0 and 60 secs in 1 sec increments using the left/right buttons.</p> <p>When active the release delay countdown will be visible on the LCD providing notification of time until an extinguishant release.</p> <p>Important! If using the ZXT with Sigma SI status indicators the delay time must be set to a multiple of 5 i.e. 5s, 10s, 15s etc. as Sigma SI status indicators will not recognise delay settings that are not a multiple of 5.</p> <p>Default: 30s</p>

<p>RELEASE DELAY AUTO</p>	<p>This option configures the delay period between a release activation and operation of the extinguishing output i.e. countdown to gas release when triggered by an automatic detection device(s).</p> <p>The delay is configurable between 0 and 60 secs in 1 sec increments using the left/right buttons.</p> <p>When active the release delay countdown will be visible on the LCD providing notification of time until an extinguishant release.</p> <p>Important! If using the ZXT with Sigma SI status indicators the delay time must be set to a multiple of 5 i.e. 5s, 10s, 15s etc. as Sigma SI status indicators will not recognise delay settings that are not a multiple of 5.</p> <p>Default: 30s</p>
<p>RELEASE DURATION</p>	<p>This option configures how long the extinguishing output remains active once triggered, this will be dependent on the solenoid type used.</p> <p>The left/right buttons allow the adjustment of the setting from 60 - 600 secs in 5 sec increments or the setting can be infinite so the output remains permanently active until the system is reset.</p> <p>Important! When setting the release duration it is important to take into consideration the specification of the extinguishing solenoid output - Max 1A continuous or 3A for 50ms.</p> <p>Default: 60s</p>
<p>EXT 1 RELEASE TIME</p>	<p>This menu setting will only appear when the ZXT is configured with Sounder S2 as a second extinguishing output.</p> <p>The EXT 1 release time is the length of time the primary extinguishing output (Exting.) remains active, this can be set from 60 - 600 secs or as infinite (i.e. permanently active until panels reset).</p> <p>The left/right buttons are used to change the setting value from 60 - 600 secs in 5 sec increments, or you can scroll through to INFINITE.</p> <p>Default: 60s</p>
<p>EXT 2 RELEASE TIME</p>	<p>This menu setting will only appear when the ZXT is configured with Sounder S2 as a second extinguishing output and extinguishing outputs are set as common operation.</p> <p>The EXT 2 release time is the length of time extinguishing output 2 (S2) remains active, this can be set from 60 - 600 secs or as infinite (i.e. permanently active until panels reset).</p> <p>The left/right buttons are used to change the setting value from 60 - 600 secs in 5 sec increments, or you can scroll through to INFINITE.</p> <p>Default: 60s</p>
<p>EXT 2 RELEASE DELAY</p>	<p>This menu setting will only appear when the ZXT is configured with Sounder S2 as a second extinguishing output and extinguishing outputs are set as common operation.</p> <p>The EXT 2 release delay enables an extended delay to be configured for the second extinguishing output (S2), this allows the second extinguishing output (S2) to be operated after the operation of the primary extinguishing output. This delay will only start once the "Release Delay Auto" or the "Release Delay Manual" has completed.</p> <p>The left/right buttons are used to change the setting value from 0-60 secs.</p> <p>Default: 30s</p>

<p>CALIBRATE EXT 'n'</p>	<p>Extinguishing outputs are monitored for short circuit and open circuit faults, to do this the panel must be calibrated to the resistance of the solenoid.</p> <p>This option will automatically calibrate the extinguishing output circuit by highlighting the menu option and pressing enter, a confirmation message will appear at the bottom of the screen EXT OP CALIBRATED.</p> <p>If output S2 is configured as a second extinguishing output then two calibrate options will be available:</p> <p>CALIBRATE EXT1 - EXT1 refers to the main extinguishing output</p> <p>CALIBRATE EXT2 - EXT2 refers to S2 if configured as a second extinguishing output.</p>
<p>EXTRACT SETTINGS..</p>	<p>This menu option will only be visible when one of the panel relay outputs has been configured as an extract output.</p> <p>The option allows configuration of any output which is used to activate an extract system.</p>
<p>DURATION</p>	<p>This option configures the length of time the extract output remains active i.e. how long the extract fan will run.</p> <p>The left/right buttons are used to change fan duration in 0, 15, 30, 60, 90 & 120 minute time periods.</p> <p>Default: 0min</p>
<p>START EXTRACT</p>	<p>If a duration time has been configured as above then the START EXTRACT option will appear on the screen.</p> <p>This option will determine when the extract output will turn on thus activating an extract fan to remove any extinguishing gas from the risk area.</p> <p>The option can be set to activate the extract output automatically or manually:</p> <p>AUTO - When set to Auto the extract fan output will be turned on automatically once the release duration timer has expired.</p> <p>MANUAL - When set to manual the extract fan output can be manually controlled either via activation of a programmed input or EXTRACTOR FAN function in the USER (Access Level 2) menu.</p>
<p>PROG I/P SETTINGS..</p>	<p>This menu is used for programming the function associated with the two non-monitored inputs P1 and P2 provided in the ZXT. Section 3 "Input Circuits" lists the various functions that can be attached to these inputs.</p> <p>Each input can be programmed independently when the input settings menu is selected, it is then required to select the Panel input you wish to configure.</p> <p>Opening the relevant Panel input screen there are two lines shown. This first line is the Panel function, the left/right buttons can be used to scroll between the different panel functions available.</p> <p>The second line is for user text where applicable, functions which can be programmed with user description text will have default text of PROG 1 or PROG 2 show on the second line. To enter a text description use the left and right arrow keys to move along the line and the up and down arrow keys to scroll through the letter selection.</p>

<p>RELAY SETTINGS..</p>	<p>The relay outputs provided in the ZXT Control Panel (FIRE, FAULT, REL, MODE, HOLD, ABORT) are fully programmable for specific functions, each output is independently configurable.</p> <p>This option allows configuration of the required function to each available output. Details regarding each available function can be found in Section 3 "Output Circuits".</p> <p>To change the functionality of the required relay select the relay from the list, use the up/down buttons to move up and down the list of functions available and the left/right buttons to toggle between "YES" and "NO".</p> <p>The function which is set as "YES" is the one programmed to the relay operation.</p> <p>Warning: Relays have been configured as default to comply with the requirements of EN54-2 and EN12094-1 changing the relay functionality will impact on compliance.</p>
<p>SOUNDER SETTINGS..</p>	<p>This menu option is used to configure the operation of the common Sounder outputs S1 and S2, each Sounder output is independently configurable however the configurable options are identical for both.</p> <p>Important! If Sounder output S2 is configured as an extinguishing output there will be no configuration options for S2 within this menu. The configuration options available are:</p>
<p>RING</p>	<p>This option configures the ring pattern associated with the Sounder outputs. There are 4 ring patterns that can be configured:</p> <p>STEADY The Sounder output is permanently switched on.</p> <p>PULSE 1 Operates the Sounder output as 1 sec on, 1 sec off</p> <p>PULSE 2 Operates the Sounder output as 2 sec on, 1 sec off.</p> <p>PULSE 3 Operates the Sounder output as 3 sec on, 1 sec off.</p> <p>Default: STEADY</p>
<p>SILENCEABLE</p>	<p>This option configures whether the Sounder(s) will silence when the silence alarms button is pressed on the Control Panel fascia.</p> <p>Select the Sounder output and use the left/right buttons to toggle between "YES" and "NO". If the option is set to "Yes" the Sounders will stop operating when the silence alarms button is pressed.</p> <p>If set to "No" the Sounders will continue to operate until the Panel is reset, the silence alarms button will have no effect.</p> <p>Default: NO</p>
<p>RESOUND DIFF ZONE</p>	<p>If the Sounders have been silenced, the ZXT can be configured to ensure the Sounders resound if another alarm is activated in a different zone.</p> <p>Use the left/right buttons to toggle the setting between "ON" and "OFF".</p> <p>Default: ON</p>

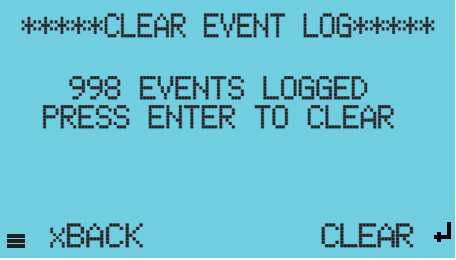
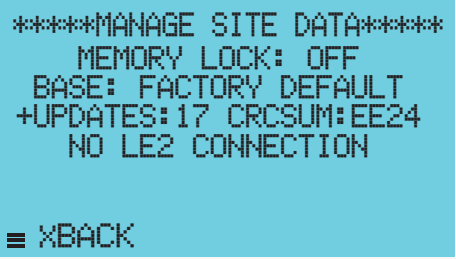
<p>CLEAR EVENT LOG..</p>	<p>The Sigma ZXT is provided with an event log which records all events that occur on the Panel along with a time and date stamp. This provides a history of the Panels changes, activations, faults etc. which can assist with diagnostics.</p> <p>Further details regarding the event log are described in the Access Level 2 sub section. To clear the event log select the "CLEAR EVENT LOG" option and the clear event log screen will appear:</p> 
<p>SERVICE DUE DATE</p>	<p>This allows the engineer to enter a date when the next planned service of the system is due. When the due date is reached the Panel will display a message on the LCD "Service Due dd/mm/yy.</p> <p>This message will remain on the LCD until the service due date has been changed.</p>
<p>MANAGE SITE DATA</p>	<p>This is a screen which is used to show details of the panel configuration, while also providing the ability to accept config changes or alternately reset config to factory default settings. If making changes to the panels configuration you will not be able to accept the config changes without accessing this screen and clicking on enter to commit changes as shown on the screen-shot below right.</p> <p>The default display of this screen will show details regards the config and provide the option to reset the config (RESET CFG) to factory default settings by pressing the enter key as shown in the screenshot below left.</p>  <p>The screen shows the following information:</p> <p>MEMORY LOCK This will show either "LOCKED" or "UNLOCKED" and indicates the status of the Memory Lock switch. "UNLOCKED" indicates the memory lock switch is off, "LOCKED" indicates the Memory Lock switch is on.</p> <p>BASE This shows a reference to the last accepted configuration setting. As configuration changes are accepted the code reference here will change. This code can be compared to the previous code to confirm a config change.</p> <p>UPDATES This shows how many edits have been made to the configuration during the last level 3 access.</p> <p>EDITS CRCSUM This is a checksum code which relates to the panel configuration, the panel will check this code to make sure the configuration is as expected.</p> <p>NO LE2 CONNECTION This line will display the connection status of a PC running LE2 programming software.</p>
<p>LOGOUT..</p>	<p>Exits the Engineering Menu.</p>
<p>DIAGNOSTICS INFO..</p>	<p>Diagnostics info shows circuit calibration values for all monitored inputs and outputs. This information can be provided to Kentec support when experiencing issues with the ZXT system to help with investigation.</p>

Connection to LE2

The ZXT panel is compatible with LE2 configuration software which allows programming via PC as well as the ability to download config and event log files.

To be able to connect LE2 to a ZXT panel the following will be required:

- Active LE2 account with ZXT database
- USB A to USB Type B micro lead

Figure 5-3
ZXT Connection to PC

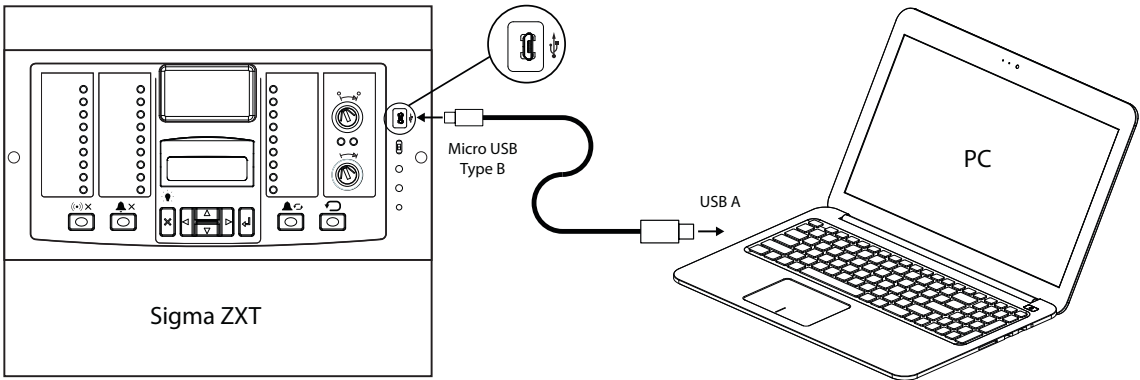

To request an LE2 account or access to the ZXT database contact Kentec Tech Support.

Section 6

Adding/Removing Status Indicators & Ancillary Boards

Sigma ZXT/XT Status Indicators and Ancillary Boards can be connected to ZXT Extinguishing Control Panels to expand the performance and functionality of the system.

A single Sigma ZXT Panel can support up to 7x Status Indicators and 7x Ancillary Boards, connected to the RS485 data bus.

Man-1453 will provide more details on installation of Status Indicators, Man-1095 will provide further details on installation of Ancillary Boards.

This section of the Manual details how to register Status Indicators and Ancillary Boards onto a ZXT Extinguishing Panel and assumes all necessary wiring, links and switches are completed as detailed in the relevant installation Manuals Man-1453 and Man-1095.

Adding a Status Unit to a ZXT

Sigma ZXT & Sigma XT Status Indicators are supported and these instructions apply for both variants:

1. Check wiring and address switch settings on each unit connected to the ZXT.

Important! Double addressing of Status Indicators can cause performance issues therefore it is important to check unit addresses before powering the system.

2. Power-up the Panel and Status Indicators. The ZXT will automatically identify any Status Indicators, their addresses and will indicate them as UNEXPECTED on the ZXT LCD as shown in the screen-shot below.

Note. An unexpected device is one detected by the Panel which has not been registered onto the configuration. Un-installed Status Indicators will show all LED's illuminated and will sound any buzzers until install is complete.

Figure 6-1
Unexpected Status Indicator

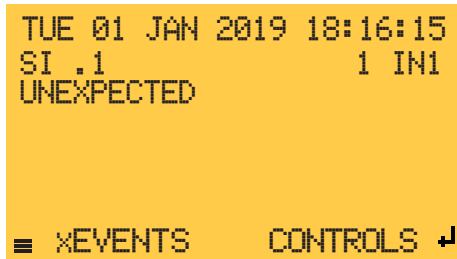

3. To install the Status Indicators enter the Engineering Menu (Access Level 3) on the LCD and select the CONNECTED DEVICES menu option.

Figure 6-2
Connected Devices

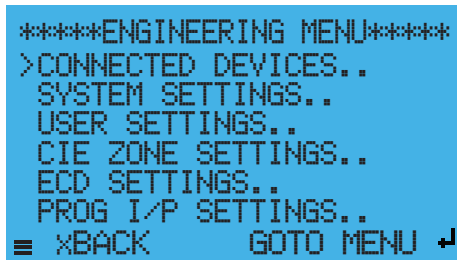

- In the CONNECTED DEVICES screen, select the REMOTE BUS option to open the REMOTE BUS STATUS screen.

Figure 6-3
Remote Bus

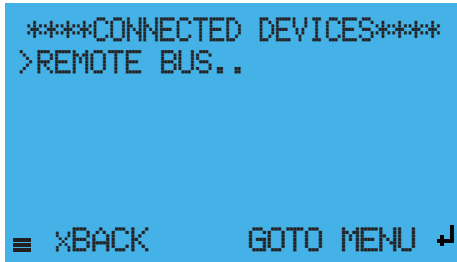

- The REMOTE BUS STATUS screen provides a synopsis of what devices are connected and whether they have been installed on the panel.

Figure 6-4
Remote Bus Status

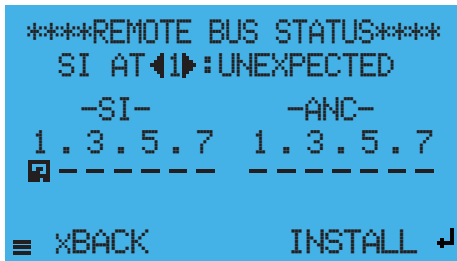

- Below the screen header is a line showing the status of individual devices, the **left and right** arrow buttons can be used to scroll through the addresses and see the status of each address.

The addresses 1-7 are shown for each group of Status Indicator/s Units and Ancillary Boards/s (ANC). Status will be shown as OPERATIONAL, NONE, UNEXPECTED or MISSING. A symbol will be displayed for each device beneath its corresponding address number.

The table below provides an overview of Remote Bus Status indications:

Symbol	Status	Description
□	OPERATIONAL	Indicates the device with this address is registered onto the panel and is working correctly.
-	NONE	Indicates there is currently no device associated with this address.
◻	UNEXPECTED	Indicates a new device has been added to the ZXT panel SI Bus which has not yet been registered on the panel. Unexpected devices will be indicated as a general fault on the ZXT panel.
⊠	MISSING	Indicates a device has been removed or is no longer communicating with the system.

The following screen-shot shows an **example** of a system with OPERATIONAL, NONE and UNEXPECTED devices.

Figure 6-5
Example Remote Bus Status

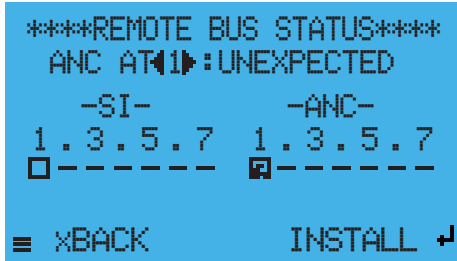

7. To add a device use the **left and right** arrows to select the unexpected device to add in the device status line and press the enter key (INSTALL). This will log the device onto the panel and the unexpected device fault will clear.

The status will change to OPERATIONAL in the status line and the graphic symbol for this address will change to □. The status LEDs should display their normal state and any buzzers will stop sounding. Complete this for all unexpected devices until all devices are logged on to the panel.

Removing a Status Indicator



The following instructions detail how to remove a Status Unit from a ZXT system, this process is the same for both Sigma ZXT and Sigma XT Status Indicators.

Important! For safety reasons power must be removed from the ZXT control panel before carrying out any modifications to an extinguishing control system.

1. With the system powered down disconnect the device from the circuit and make the circuit good.
2. Power-up the Control Panel and the LCD should show a missing device fault with details of the device and device address that is missing, see screen-shot below. A missing Status Indicator will also activate a hold operated status this is due to the monitored hold input on the removed Status Indicator not being present.

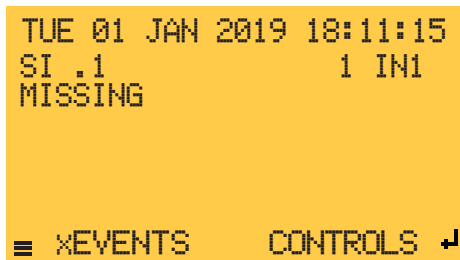
Figure 6-6
Missing Status Indicator



3. Enter the Engineering Menu (Access Level 3) and select the DEVICES CONNECTED option and then select the REMOTE BUS option to open the REMOTE BUS STATUS screen.
4. The REMOTE BUS STATUS indicates the missing Status Indicator with the following symbol . Using the **left and right** arrow buttons scroll to display the address of the missing device on the status line.
5. To remove the device from the ZXT configuration press the enter button (UNINSTALL) the status line for this address will show none and the graphical status icon will show .
6. The Panel will still indicate a hold operated state as this is a latching condition. Complete the removal of the Status Unit by pressing the 'Reset' button on the fascia to clear the hold operated event.

Note: Status Indicators can be un-installed from the configuration while being left as part of the physical circuit, however this will cause the Status Unit to flash all LED's and sound its local buzzer (if fitted) to indicate a 'comms' fault.

Adding an Ancillary Board to a ZXT

1. Check wiring and address switch settings on each unit connected to the ZXT.

Important! Double addressing of Status Indicators can cause performance issues therefore it is important to check unit addresses before powering the system.

2. Power-up the Panel and Ancillary Boards. The ZXT will automatically identify any Ancillary Boards, their addresses and will indicate them as UNEXPECTED on the ZXT LCD, as shown in the screen-shot below.

Note. An unexpected device is one detected by the Panel which has not been registered onto the configuration.

Figure 6-7

Unexpected Ancillary Board

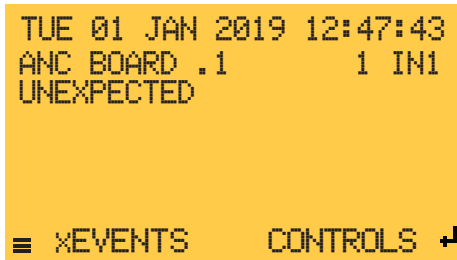

3. To install Ancillary boards enter the Engineering Menu (Access Level 3) on the LCD and select the CONNECTED DEVICES menu option.

Figure 6-8

Connected Devices



4. In the CONNECTED DEVICES screen, select the REMOTE BUS option to open the REMOTE BUS STATUS screen.

Figure 6-9

Remote Bus



- The REMOTE BUS STATUS screen provides a synopsis of what devices are connected and whether they have been installed on the Panel.

Figure 6-10
Remote Bus Status

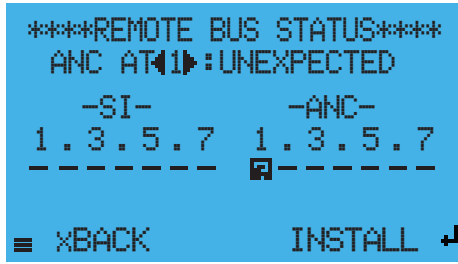

- Below the screen header is a line showing the status of individual devices, the **left and right** arrow buttons can be used to scroll through the addresses and see the status of each address.

The addresses 1-7 are shown for each group of Status Indicator/s (SI) and Ancillary Board/s (ANC). Status will be shown as OPERATIONAL, NONE, UNEXPECTED or MISSING. A corresponding symbol will be displayed for each device beneath its address number.

The table below provides an overview of Remote Bus Status indications:

Symbol	Status	Reason
□	OPERATIONAL	Indicates the device with this address is registered onto the panel and is working correctly.
-	NONE	Indicates there is currently no device associated with this address.
▣	UNEXPECTED	Indicates a new device has been added to the ZXT panel SI Bus which has not yet been registered on the panel. Unexpected devices will be indicated as a general fault on the ZXT panel.
⋮	MISSING	Indicates a device has been removed or is no longer communicating with the system.

- To add a device use the **left and right** arrows to select the unexpected device to add in the device status line and press the enter key (INSTALL). This will log the device onto the Panel and the unexpected device fault will clear. The status will change to OPERATIONAL in the status line and the graphic symbol for this address will **change to** □. Complete this for all unexpected devices until all devices are logged on to the panel.

Removing an Ancillary Board

The following instructions detail how to remove an Ancillary Board from a ZXT system.



Important! For safety reasons power must be removed from the ZXT control panel before carrying out any modifications to an extinguishing control system.

1. With the system powered down disconnect the device from the circuit and make the circuit good.

Power-up the Control Panel and the LCD should show a missing device fault with details of the device and device address that is missing, see screen-shot below.

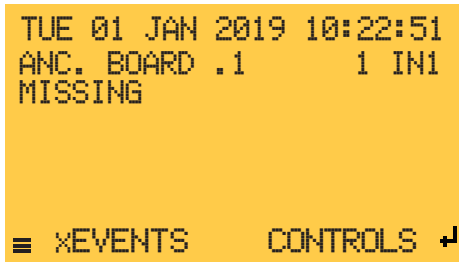
Figure 6-11
Missing Ancillary Board



2. Enter the Engineering Menu (Access Level 3) and select the DEVICES CONNECTED option and then select the REMOTE BUS option to open the REMOTE BUS STATUS screen.
3. The REMOTE BUS STATUS indicates the missing device on the graphic with the following symbol . Using the **left and right** arrow buttons scroll to display the address of the missing device on the status line.
4. To remove the device from the ZXT configuration press the enter button (UNINSTALL) the status line for this address will show none and the graphical status icon  will show.
5. The device has now been removed from the system and any associated faults will have cleared.

Section 7

Maintenance & Assistance

Sigma ZXT control panels do not require any specific maintenance but should the control panel become dirty it can be wiped over with a barely damp cloth. Detergents or solvents should not be used to clean the panel and care must be taken that water does not enter the enclosure.

The control panel contains sealed lead acid batteries to provide standby power in the event of mains failure. These batteries have a life expectancy of around 4 years. It is recommended that these batteries be tested in accordance with the battery manufacturer's recommendations annually to determine their suitability for continued standby applications.

Important! Testing of the extinguishant system should only be carried out by trained personnel and must be done with appropriate isolation measures in place to ensure that accidental discharge of the extinguishant agent is avoided.

If You Need Help

If you need technical support contact Kentec at + 44 (0) 1322 222121 or e-mail the department, techsupport@kentec.co.uk. Kentec technical support is available Monday through Friday, 8:30 AM to 5:00 PM.

Limited Returns and Repairs Policy

In-Warranty Items

All equipment supplied by Kentec Electronics Ltd is provided with a warranty, as defined in Section 8 (Warranties & Liability) of the Terms and Conditions of Sale. These warranties are between Kentec Electronics Ltd (the Seller) and the company that placed the order upon the seller (the Buyer). The warranty period is valid for 36 months from the delivery date and is non-transferable.

Damaged Goods

In the event of damage to equipment during transit or any defect in the quality of goods, the Buyer shall notify Kentec Electronics Ltd within seven days of delivery as detailed in the Terms & Conditions of Sale. The goods may then be returned to the Customer Service Department of Kentec Electronics Ltd. for repair, or replacement parts may be supplied (by arrangement).

Component Failure

In the event of a defect of the supplied equipment during the warranty period, due to defective materials or workmanship, then replacement parts shall be supplied to the Buyer using the Service Replacement Item (SRI) scheme.

Service Replacement Items

The Buyer shall request the replacement part(s) required from the Customer Service Department. This request shall be made by e-mail to sales@kentec.co.uk and shall include the parts required, the panel Works Order (W/O) Number and the required delivery address.

If the Buyer is not aware of the required replacement part(s), additional advice may be obtained from the Technical Support Department of Kentec Electronics Ltd. Once the SRI has been approved, items are normally dispatched for next day delivery within the mainland UK, subject to stock availability.

SRI parts are supplied on the following terms and conditions:

- SRI parts are loan items and are not available for resale.
- At all times, Kentec Electronics Ltd. retains the title of SRI parts supplied, as detailed in Kentec's Terms and Conditions of Sale.
- All SRI parts must be returned to the Customer Service department of Kentec Electronics Ltd within 14 days of delivery.

- Any SRI parts that have not been returned within 28 days of delivery will be invoiced at the price given in the Kentec Price List, less discount.
- Any returned items that are found to have failed due to fair wear and tear, willful damage, negligence, abnormal working conditions, misuse or alteration or repair without the Suppliers approval or failure to follow the sellers instructions will be subjected to a repair fee of up to the price given in the Kentec Price List, less any discount.
- Any returned items that are not part of the original equipment or are not in warranty will be invoiced at the price given in the Kentec Price List, less discount where applicable.
- All SRI parts shall be returned in the same packaging as the replacement parts were supplied in. Failure to ensure that adequate anti-static precautions are taken during the replacement of parts, or in the return of SRI parts may result in an invoice of up to the price given in the Kentec Price List, less any discount.
- Any SRI parts returned without the completed SRI delivery report or any SRI reference documentation will be invoiced at the price given in the Kentec Price List, less any discount. The right to receive Service Replacement Items is regularly reviewed and may be withdrawn from persistent abusers of this facility.
- Kentec reserve the right not to supply SRI items without prior notice.

Repair Warranties

Repaired items are not covered by the normal Warranties and Liability conditions in the Terms and Conditions of Sale. Subsequent failures of repaired items will only be covered if the failure is due to a material or workmanship defect directly associated with the repair and for a period not exceeding three months from the date of the repair.

Kentec Electronics Ltd are under no liability if the repaired or replaced components are found to have failed due to fair wear and tear, willful damage, negligence, abnormal working conditions, misuse or alteration or repair without approval or failure to follow the sellers instructions.

Out Of Warranty Items

Kentec Electronics Ltd provides a test and repair facility for most standard and special build products. This facility can also recondition control panels, subject to availability of components.

Customer Repairs

Items for repair shall be returned to the Customer Service Department of Kentec Electronics Ltd. Any items returned for repair must be accompanied with the following:

- A request for repair work to be undertaken.
- A customer contact name.
- Details of the company requesting the repair.
-

Failure to supply the required information will result in the returned items being quarantined for a period not exceeding 60 days. If the items are not identified within 60 days of receipt, then Kentec Electronics Ltd. reserves the right to dispose of these items or return them.

A written quotation will be provided for all items to be repaired that are not included in the repair prices section of the Kentec Price list. No repairs or refurbishment will be undertaken without prior authorisation from the customer and a written order for the repair work. Returned equipment will be held awaiting authorisation for a period not exceeding 60 days from the date of quotation. After this period, Kentec Electronics Ltd. reserves the right to dispose of these items or return them.

Section 7 LCD Menu Structure

The following diagrams provide an overview of the LCD menu structure. Panel functions are shown throughout Access Levels 1, 2 and 3.

Figure 7-1
Access Level 1

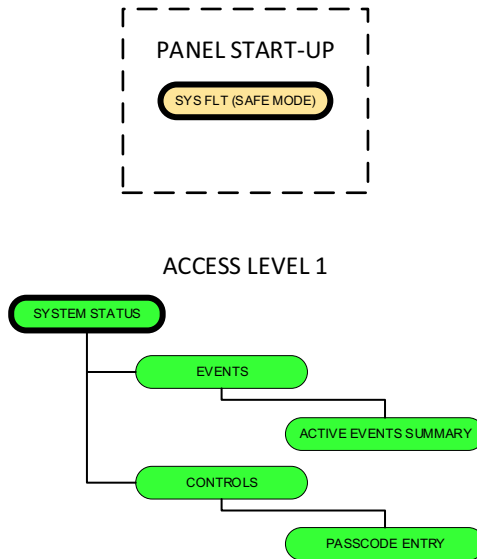

Figure 7-2
Access Level 2

ACCESS LEVEL 2

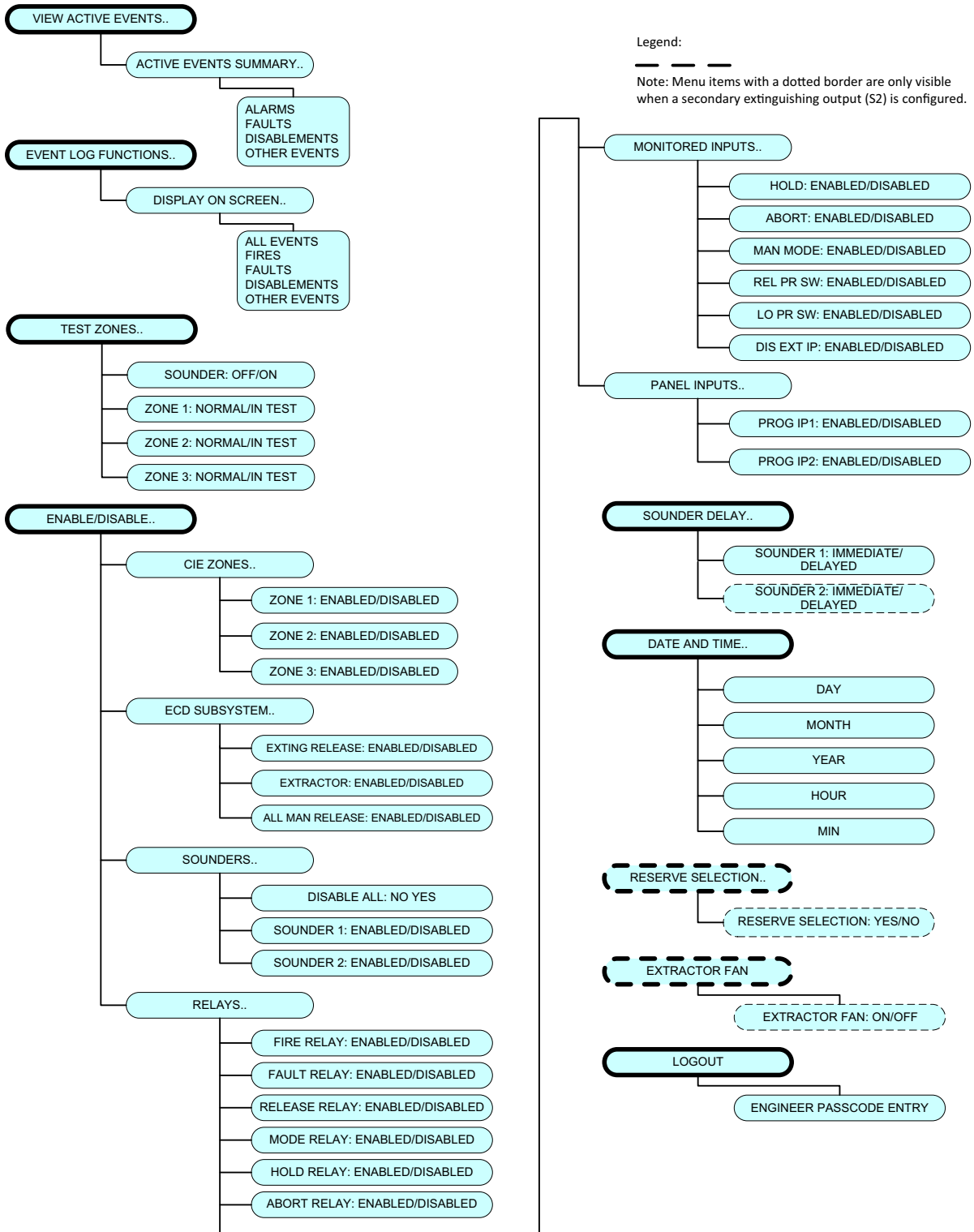

Figure 7-3
Access Level 3

ACCESS LEVEL 3 (Engineering)

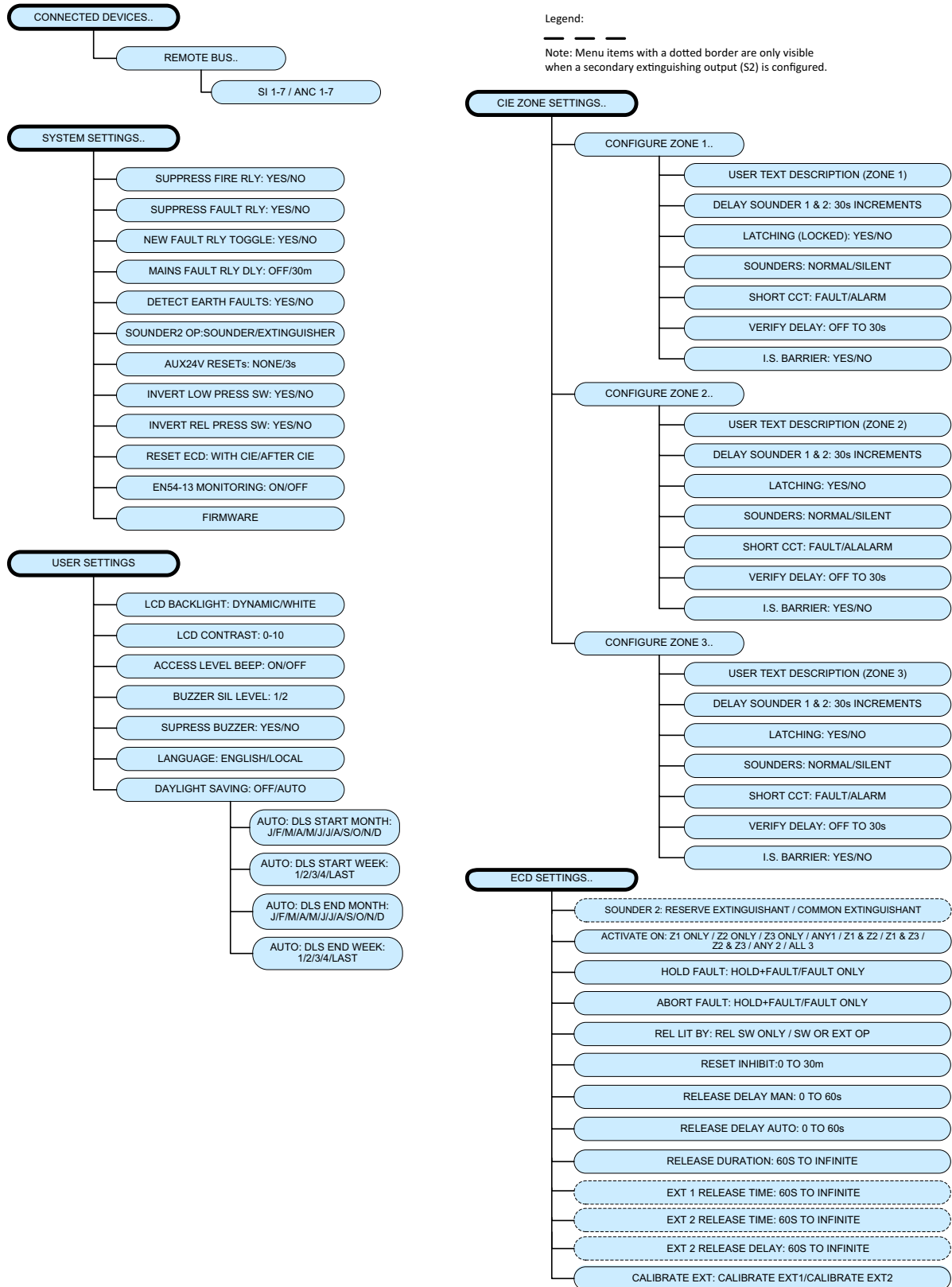
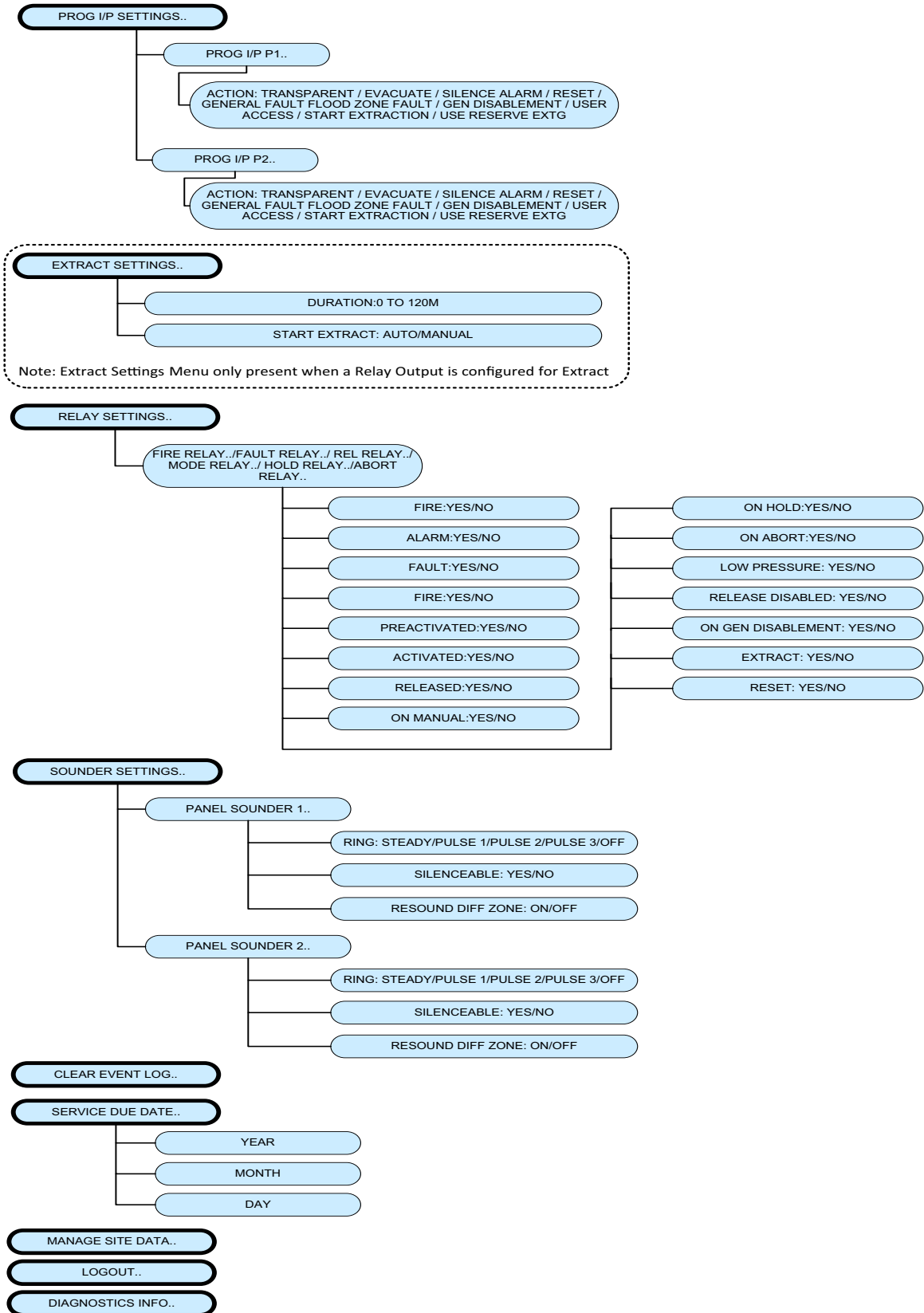

Figure 7-4
Access Level 3 (Continued)



Appendix A Specification

Mechanical

Item	Version	Details
Enclosure construction	Standard/Large	1.2mm/1.5mm mild sheet steel
Enclosure finish	Standard/Large	Epoxy powder coat
Enclosure colour	Standard/Large	BS 00-A-05 grey (fine texture)
Panel weight	Standard/Large	6Kg/7Kg (excluding batteries)

Electrical

Item	PSU	Electrical Rating	Comments	Parameters
Mains supply	S420 (2.6A)	230V AC, 50Hz +10 - 15%	100W maximum	Standard European mains connection
	S406 (5.25A)			
Mains supply fuse	S420 (2.6A)	T2.0 A 20mm, 250V AC HRC	Replace only with similar type.	
	S406 (5.25A)	T3.0 A 20mm, 250V AC HRC		
Power supply rating	S420 (2.6A)	2.6A total including battery charge 28V +/-1V		
	S406 (5.25A)	5.25A total including battery charge 28V +/-1V		
I _{max a}	S420 (2.6A)	395mA without charger current (600mA)		
	S406 (5.25A)	395mA (1.25A with charger)		
I _{max b}	S420 (2.6A)	2.0A		
	S406 (5.25A)	5.25A		
I _{min}	S420 (2.6A)	75mA		
	S406 (5.25A)	75mA		
R _i Max	S420 (2.6A)	1 Ohm		
	S406 (5.25A)	1 Ohm		
Output Voltage	S420 (2.6A)	20.3 - 28.3V DC		
	S406 (5.25A)	19 - 28.5V DC		
Maximum ripple voltage	S420 (2.6A)	<200mV peak to peak @ rated voltage.		
	S406 (5.25A)			
Battery type	S420 (2.6A)	7Ah: Yuasa NP7-12		
	S406 (5.25A)	12Ah: Yuasa NP12-12 17Ah: Yuasa NP17-12	Larger enclosure required when using 12/17Ah batteries.	

Battery charge voltage	S420 (2.6A)	27.6V DC nominal (temperature compensated).		Modulated DC
	S406 (5.25A)			
Battery charge current	S420 (2.6A)	0.6A		Modulated DC
	S406 (5.25A)	1.25A		
Battery fuse	S420 (2.6A)	20mm F2.5A 250V	Replace only with similar type.	
	S406 (5.25A)	Electronic over current protection circuit present		
Current draw in mains fail condition	S420 (2.6A)	0.11A		
	S406 (5.25A)	0.14A		
Current draw in second stage alarm	S420 (2.6A)	0.19A	Stand allow system without any outputs being loaded.	
	S406 (5.25A)	0.23A		
Current draw in post discharge condition	S420 (2.6A)	0.21A	Stand allow system without any outputs being loaded.	
	S406 (5.25A)	0.26A		
R 0V output	S420 (2.6A)	Fused at 500mA with electronic fuse		
	S406 (5.25A)			
Maximum current draw from batteries	S420 (2.6A)	2.0A		
	S406 (5.25A)	5.5A		
Quiescent current battery cut-off	S420 (2.6A)	<1mA @27.6V		
Battery monitoring current consumption	S420 (2.6A)	<1mA@24V		
Sounder Outputs	S420 (2.6A)	21 to 28V DC. Fused at 500mA with electronic fuse.	1.6A load over all circuits	Voltage reversing DC.
	S406 (5.25A)			
Fault relay contact rating	S420 (2.6A) / S406 (5.25A) PSU	5 to 30V DC 1A max. for each	Maximum ratings not to be exceeded.	Volt free changeover contact.
Fire relay contact rating	S420 (2.6A) / S406 (5.25A) PSU	5 to 30V DC 1A max. for each	Maximum ratings not to be exceeded.	Volt free changeover contact.
Released relay contact rating (RK48)	S420 (2.6A) / S406 (5.25A) PSU	5 to 30V DC 1A max. for each	Maximum ratings not to be exceeded.	Volt free changeover contact.
Mode relay contact rating	S420 (2.6A) / S406 (5.25A) PSU	5 to 30V DC 1A max. for each	Maximum ratings not to be exceeded.	Volt free changeover contact.
Hold relay contact rating	S420 (2.6A) / S406 (5.25A) PSU	5 to 30V DC 1A max. for each	Maximum ratings not to be exceeded.	Volt free changeover contact.
Abort relay contact rating	S420 (2.6A) / S406 (5.25A) PSU	5 to 30V DC 1A max. for each	Maximum ratings not to be exceeded.	Volt free changeover contact.
Zone quiescent current	S420 (2.6A) / S406 (5.25A) PSU	0mA minimum, 2mA maximum		
Terminal capacity	S420 (2.6A) / S406 (5.25A) PSU	0.5mm ² to 2.5mm ² solid or stranded wire		

Maximum number of detectors per zone	S420 (2.6A) / S406 (5.25A) PSU	32	The number of detection devices supported per zone will vary dependent on detector manufacturer. The current rating of the zone circuit and zone devices should be reviewed at system design stage. To ensure compliance with circuit monitoring requirements no more than 32 devices should be fitted to any one zone.	
Detection circuit end of line	S420 (2.6A) / S406 (5.25A) PSU	6K8 +/- 5% 0.5W resistor		
Monitored input end of line	S420 (2.6A) / S406 (5.25A) PSU	6K8 +/- 5% 0.5W resistor		
No. of detection circuits	S420 (2.6A) / S406 (5.25A) PSU	3		
Zone detection circuits	S420 (2.6A) / S406 (5.25A) PSU	21.1 to 21.3V DC		
Number of sounder circuits	S420 (2.6A) / S406 (5.25A) PSU	2x 1st stage, 1x 2nd stage		
Sounder output	S420 (2.6A) / S406 (5.25A) PSU	21 to 28V DC @500mA		
Sounder circuit end of line	S420 (2.6A) / S406 (5.25A) PSU	1N4004 diode		
Number of extinguishant outputs	S420 (2.6A) / S406 (5.25A) PSU	1 (or 2 with S2 sounder output reconfigured)		
Extinguishant release output	S420 (2.6A) / S406 (5.25A) PSU	21 to 28V DC @1A		
Extinguishant release delay	S420 (2.6A) / S406 (5.25A) PSU	Adjustable 0 to 60 seconds (+/-10%)		
Extinguishant release duration	S420 (2.6A) / S406 (5.25A) PSU	Adjustable 60 to 300 seconds		
Zone normal threshold (Allowable EOL)	S420 (2.6A) / S406 (5.25A) PSU	10K to 2K Ohms		
Detector alarm threshold	S420 (2.6A) / S406 (5.25A) PSU	1K to 390 Ohms		
Call point alarm threshold	S420 (2.6A) / S406 (5.25A) PSU	370 Ohms to 0 Ohm		
Short circuit threshold	S420 (2.6A) / S406 (5.25A) PSU	130 to 0 Ohms		
Head removal condition	S420 (2.6A) / S406 (5.25A) PSU	15.5 to 17.5 V +/- 5%		
Cabling	S420 (2.6A) / S406 (5.25A) PSU	FP200 or equivalent (max. capacitance 1uF. Max inductance 1 milli-henry)		

Monitored inputs normal threshold (Allowable EOL)	S420 (2.6A) / S406 (5.25A) PSU	10K to 2K Ohm		
Monitored inputs alarm threshold	S420 (2.6A) / S406 (5.25A) PSU	2K to 150 Ohms +/- 5%		
Monitored inputs short circuit threshold	S420 (2.6A) / S406 (5.25A) PSU	140 to 0 Ohms +/- 5%		
Status unit/Ancillary board connection	S420 (2.6A) / S406 (5.25A) PSU	Two wire RS485 connection (EIA 485 specification)	Total 14No: 7no. Status Units 7no. Ancillary	EIA-485 specification
Status unit power output (AUX 24V)	S420 (2.6A) / S406 (5.25A) PSU	21 to 28V DC @ 300mA	Maximum 300mA load	

Environmental

Important! This Control Panel is environmental class A and is designed for indoor use only. Operation outside these parameters may render the equipment unsafe.	
Operating temperature range	-10 to +40°C (95% relative humidity, non-condensing)
Storage temperature range	-20 to + 80°C
Ingress protection	IP30

Battery Calculation

Battery calculation formula (BS 5839-1: 2002)

$$C_{min} = 1.25((T1*I1) + D(I2*T2))$$

Cmin = minimum capacity of battery when new at a 20 hour discharge rate at 20c in ampere-hours (Ah)

1.25 = ageing factor allowing 5% per year over 4 years

T1 = battery standby period in hours

T2 = alarm time in hours (usually 0.5)

I1 = battery standby load in amperes

I2 = battery alarm load in amperes

D = battery de-rating factor (usually assumed at 1.75). This allows for the inefficiency of the battery under high load conditions

Appendix B

Glossary

Term	Meaning
AC	Alternating Current.
AUX 24	Auxiliary 24 Volt supply.
CCT	Circuit
CIE	Control and Indicating Equipment
CPU	Central Processor Unit
DC	Direct Current.
ECD	Extinguishant Control Device
EOL	End of Line (Resistor).
EXTING.	Extinguishant
FLT	Fault
I.S.	Intrinsically Safe
IDC	Insulation-Displacement Contact (connector).
I/P	Input
Knock-out	Enclosure cable entry point. Using a centre punch (or similar), apply a sharp, singular downward force, to knock-out blank.
LCD	Liquid Crystal Display.
LCK OFF	Lock Off
LCMU	Line Continuity Monitoring Unit
LED	Light Emitting Diode.
LIT	
LO PRESS	Low pressure
LVL	Level
MAN RELEASE	Manual Release
mm	Millimetres
O/P	Output
PCB	Printed Circuit Board.
PROG I/P	Programmable Input
REL	Release
REL IP	Release Input
REL PRES. SWITCH	Release Pressure Switch
RLY	Relay
S1	Sounder 1
S2	Sounder 2
S3	Sounder 3
Schottky diode	A diode which has a low forward voltage drop and a very fast switching action.
SIL	Silence
SLA	Sealed Lead Acid.
SW	Switch
Watchdog	System monitoring (safe mode).
Z	Zone