

PASSIVE INFRARED DETECTOR

**CX-702 , CX-702V**  
STANDARD ALARM MEMORY



**FEATURES**

**CX-702 / CX-702V**

- Dual Purpose Lens:Selectable "WIDE ANGLE" and "LONG RANGE" detection patterns
- Double Conductive Shielding of the pyroelectric element
  - Extremely High Light and RFI Immunity (Patent listed)
- Multifocus Optics Design (Patent listed)
- LED On/Off Switch
- Sealed Optics
- Easy Installation

**CX-702V Only**

- Alarm Memory
- LED Remote Control Terminal

※The CX-702 is UL Listed per UL639, Intrusion-Detection Units.  
※The CX-702V has not been investigated by UL.

**OPTION**

- CA-1W : Wall Mount Bracket : adjustable  $\pm 45^\circ$ (Horizontally), 0-20°(Vertically downwards)
- CA-2C : Ceiling Bracket : adjustable  $\pm 45^\circ$ (Horizontally), 0-20°(Vertically downwards)

**1.INSTALLATION HINTS**

**1**

Avoid direct sunlight.

**2**

Avoid mounting detector where movement of Fans or Air Conditioning Fans can be detected.

**3**

Avoid vapor or high humidity that can cause condensation.

**4**

Avoid Curtain, Screen, etc. blocking detection area.

**5**

Do not install outdoors.

**6**

**⚠ WARNING**

Never repair or modify product. It may cause accident, fire hazard or electric shock.

**7**

**⚠ WARNING**

When damage has occurred to the product, i.e. water logged, abnormal things inside product, overheating or smoking, strange smells etc., immediately stop using product and contact your supplier. Otherwise, continued use in such condition may cause electric shock or fire hazard.

**8**

**⚠ CAUTION**

Mount securely. A falling product may cause injury.

**2.DETECTION AREA**

**WIDE ANGLE**

**LONG RANGE**

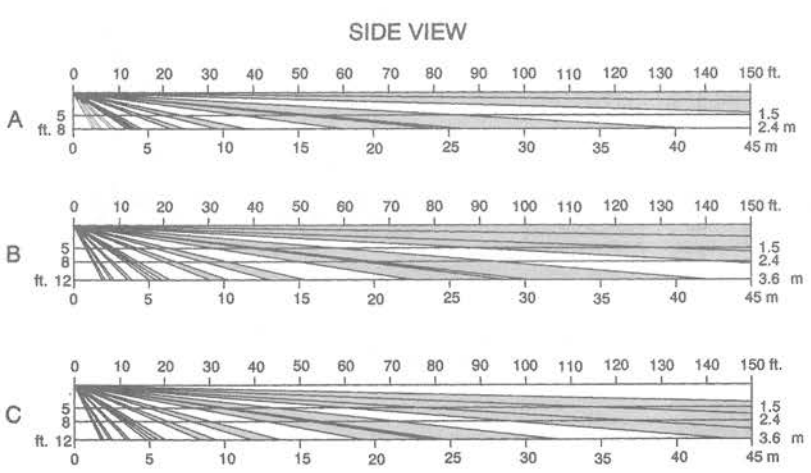
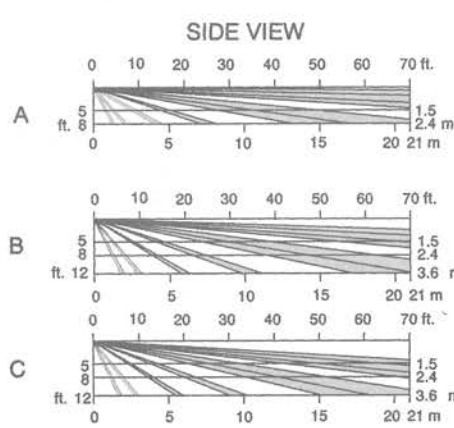
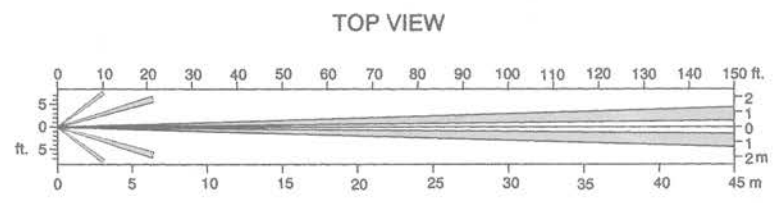
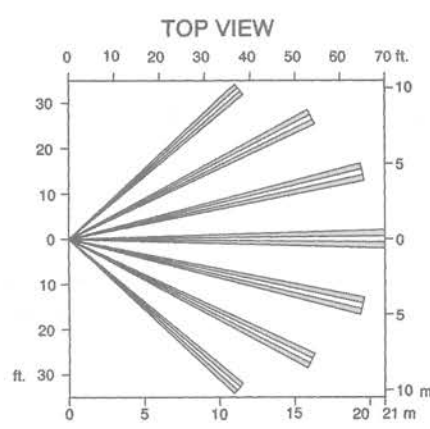

**\*\*ATTENTION\*\***  
The specified detection area can be achieved by mounting the unit at a height of 8ft.(2.4m). Mounting at a lower or higher height may reduce the area of coverage.

### 3. DESCRIPTION AND OPERATION

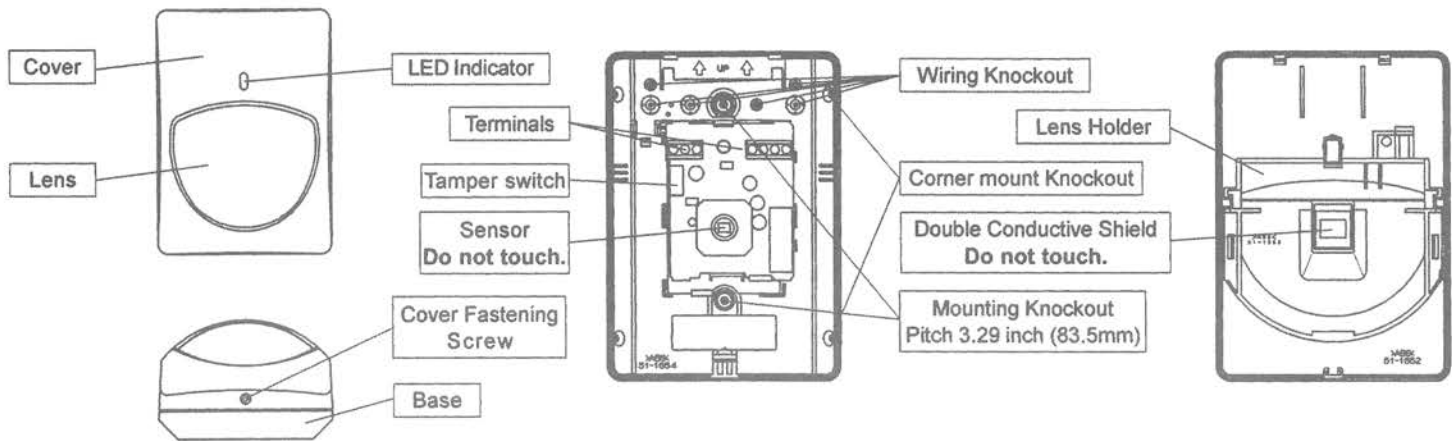

### 4. INSTALLATION

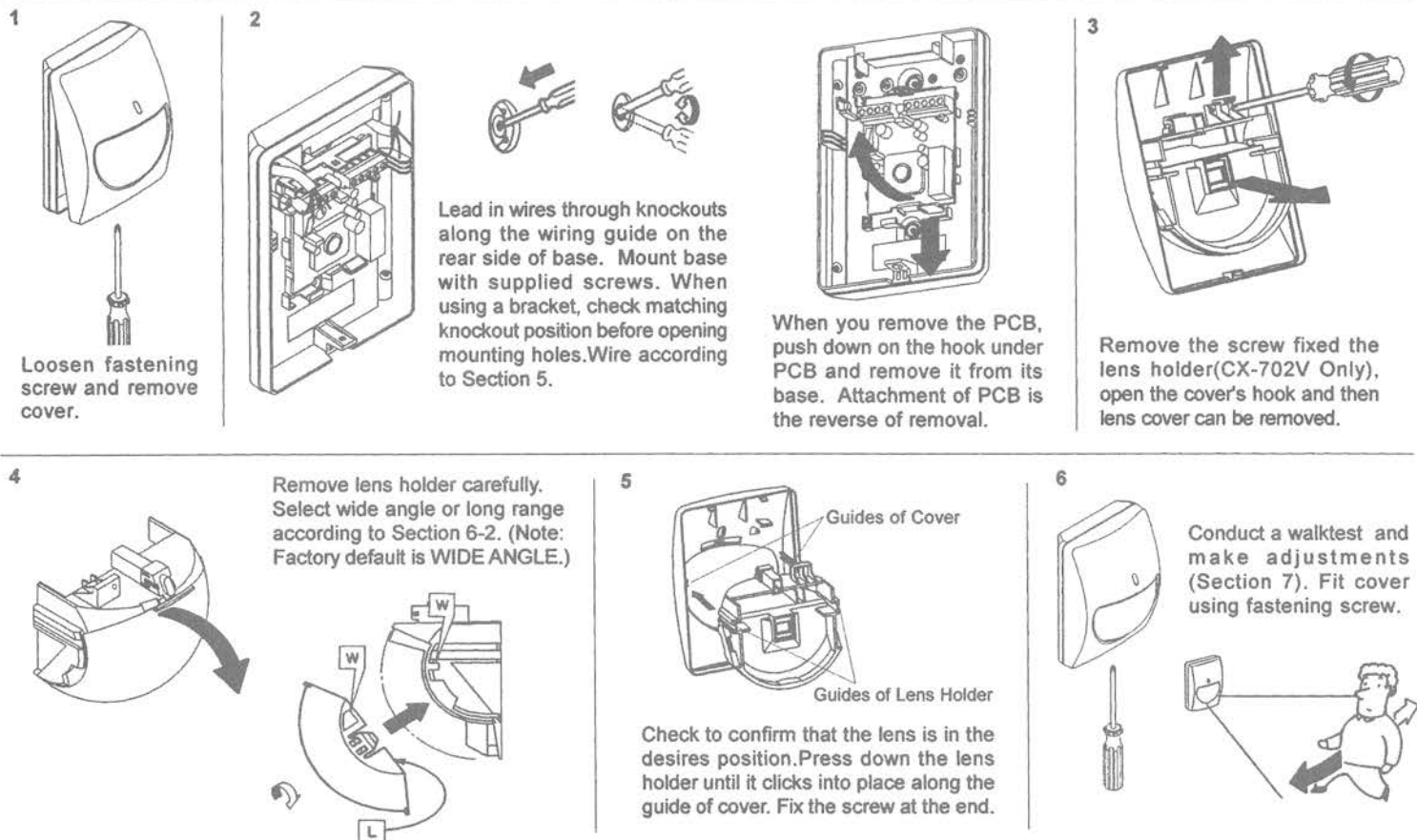

### 5. WIRING

#### CX702

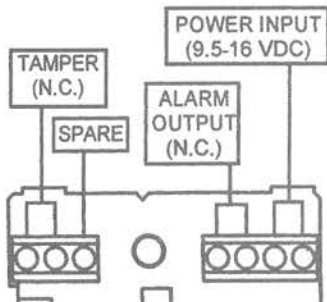

#### CX-702V

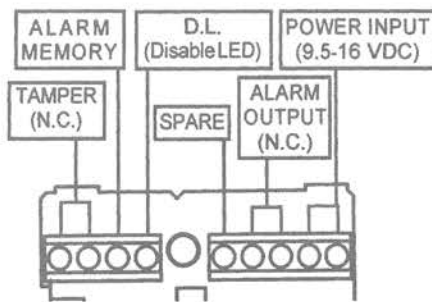

[ Connect tamper terminals to a 24 hour supervisory loop. ]

Power wires should not exceed the following lengths.

WIRE SIZE	CX-702		CX-702V	
	12V	14V	12V	14V
AWG 22(0.33mm <sup>2</sup> )	1700ft (520m)	3700ft (1130m)	1180ft (360m)	2520ft (770m)
AWG 20(0.52mm <sup>2</sup> )	2690ft (820m)	5830ft (1780m)	1830ft (560m)	4000ft (1220m)
AWG 18(0.83mm <sup>2</sup> )	4290ft (1310m)	9350ft (2850m)	2950ft (900m)	6430ft (1960m)

When using two or more units on one wire, the maximum length is obtained by dividing the maximum wire length listed above by the number of units used.

※ UL requires CX-702 to be connected to a UL listed power supply capable of providing a nominal input of 12VDC 11mA(max.) and battery standby time of 4 hours.  
 ※ For UL Listed systems, do not connect field wiring more than 25ft. to Alarm Memory, and DL terminals.  
 ※ The equipment shall be installed in accordance with the National Electrical Code, NFPA 70.

## 6. ADJUSTMENTS FOR REQUIRED AREA PATTERN

The CX-702 is designed to provide ideal detection areas for different patterns ranging from 40ft.(12m) to 70ft.(21m) Wide Angle, and 80ft.(24m) to 150ft.(45m) Long Range.  
The following adjustments will provide ideal detection areas for each of these requirements.

### 1. DETERMINE THE AREA PATTERN

Before making adjustments, determine the pattern area, detection range mounting height.

### 2. SELECTING WIDE ANGLE OR LONG RANGE DETECTION

1. Inverting the lens will select either the Wide Angle or Long Range detection patterns.
2. Please note markings "W(Wide Angle)" and "L(Long Range)", on each side of lens.
3. For Wide Angle, "W" will be on top of lens.
4. For Long Range, "L" will be on top of lens.

### 3. VERTICAL ADJUSTMENT OF DETECTION AREA

Adjust the vertical angle according to the desired detection range and mounting height.

1. Set the upper edge of the lens at either the "A", "B" or "C" position.
2. The following chart illustrates the different position setting.
3. Confirm the detection area by conducting a walktest.

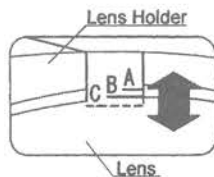

		W : WIDE ANGLE					L : LONG RANGE				
		DISTANCE					DISTANCE				
		40 (12)	50 (15)	60 (18)	70 (21)	80 (24)	100 (30)	120 (36)	150 (45)		
HEIGHT	6 (1.8)	B	A	A	A	B	B	A	A		
	8 (2.4)	C	C	C	C	C	C	C	C		
	12 (3.6)	C	C	C	C	C	C	C	C		

ft.(m)

## 7. FUNCTIONS

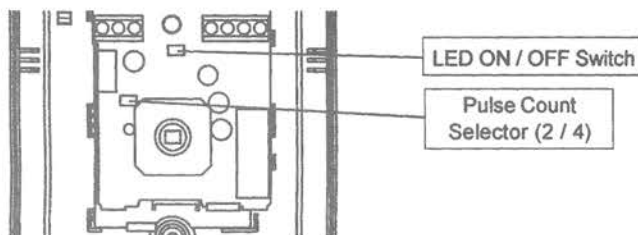

### CAUTION!

Always conduct a walktest after changing the position of this switch to ensure the detector is still providing optimum coverage.

### 1. LED ON/OFF

#### Jumper Pin Switch

The Alarm LED indicator can be switched either "ON" or "OFF".

#### D.L. terminal (CX-702V Only)

LED can be enabled or disabled remotely from control panel by D.L. terminal.

- 1) Place Jumper Pin Switch in OFF position.
- 2) LED"ON" : Connect DL terminal to common ground with detector.(0~1VDC, grounded)  
LED"OFF": No Connection to the DL terminal.(OPEN or +5~16VDC)



### 2. PULSE COUNT

The Detection Mode can be switched to either "2" or "4" mode depending on the environmental conditions of the installation.

- 2 : For normal applications.
- 4 : For use in hostile areas where there may be movement of small animals or other objects such as fax machines or curtains.

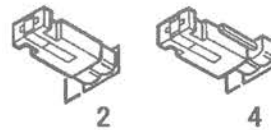

### CAUTION!

Do not use pulse count 4 for Long Range detection.

When the "4" is selected, the detector's sensitivity may seem sluggish. It is therefore important to always conduct a walktest to ensure that the desired coverage is given.

### 3. ALARM MEMORY (CX-702V Only)

#### Alarm Memory

This function is used to indicate if the detector was activated while the panel was armed. It will cause the red LED on the Detector to illuminate once the panel has been disarmed.

Compatible Control Panel is required for Alarm memory.

Connect A.M. terminal to Control Panel's Control Voltage Signal terminal (System Arming Status Voltage Output).

#### CONTROL VOLTAGE SIGNAL

	POSITIVE	NEGATIVE
System Armed	OPEN or +5~16VDC	0~1VDC(grounded)
System Disarmed	0~1VDC(grounded)	OPEN or +5~16VDC

#### Operation

If the unit triggered during armed period, when the system is disarmed, LED will remain lit to confirm that it reported an alarm.

- Alarm Memory will operate even when LED is switched OFF.
- Alarm Memory will not operate while system is disarmed.
- After Alarm Memory latches, Alarm Output and LED operate normally during armed period.

#### Reset

Alarm Memory resets automatically when system is re-armed.

#### AM Jumper



POSITIVE : Leave AM Jumper as it is.  
NEGATIVE : Cut AM Jumper as shown.

## 8. TROUBLE SHOOTING

PROBLEM	PROBABLE CAUSE	REMEDY
LED does not light.	Improper power supply voltage (disconnection, low voltage).	Correct supply voltage to 9.5 - 16V DC. See Section 5.
	Improper detection area.	See Section 2.
	LED switch is OFF.	Turn on the switch.
	Improper polarity to detector.	Switch positive and negative at terminal.
LED lights even though no person within area.	Moving object within area (curtain, wall hanging, etc.).	Remove the sources from the detection area.
	Temperature of object within area changing rapidly (heater, air conditioning, etc.).	Remove object from the detection area.
LED lights but signal is not sent.	Relay contact is stuck or damaged due to overloading.	Check load of output. The unit needs repair or replacement.
LED continues to light	Faulty wiring.	Wire correctly.
	Poor connection of alarm memory.	Reconnect wire.
	Wrong control voltage from panel.	Must be 0-1V DC (grounded) See Section 7-3.

## 9. SPECIFICATIONS

Model	CX-702 / CX-702V	
Detection method	Passive infrared	
Coverage	Wide Angle 85°wide 70ft. × 70ft. (21m × 21m)	Long Range 150ft. × 8ft. (45m × 2.4m)
	Detection zones	68 zones / 22 zones
Mounting height	5 - 12ft. (1.5 - 3.6m)	
Sensitivity	3°F at 2ft./sec., 8ft. mounting height (1.6°C at 0.6m/sec., 2.4m mounting height)	
Detectable speed	1- 5ft. / sec. (0.3 - 1.5m/sec.)	
Power input	9.5 - 16VDC	
Alarm period	Approx. 2.5 sec.	
Alarm output	N.C. 28VDC 0.2A max.	
Tamper switch	N.C. Opens when cover is removed. 28VDC 0.1A max.	
Pulse count	Approx. 20 sec. 2 or 4	
Warm-up period	Approx. 1 min.	
LED indicator	Alarm condition	
RF interference	No alarm 30V/m	
Operating temperature	-4°F - +122°F (-20°C - +50°C)	
Environment humidity	95% max.	
Weight	7.0oz (200g)	

Model	CX-702
Current draw	8mA (normal) / 11mA (max.) at 12VDC

Model	CX-702V
Current draw	8mA(normal) / 16mA(max.) at 12VDC
Alarm Memory	See Section 7-3.
D.L. terminal	See Section 7-1.

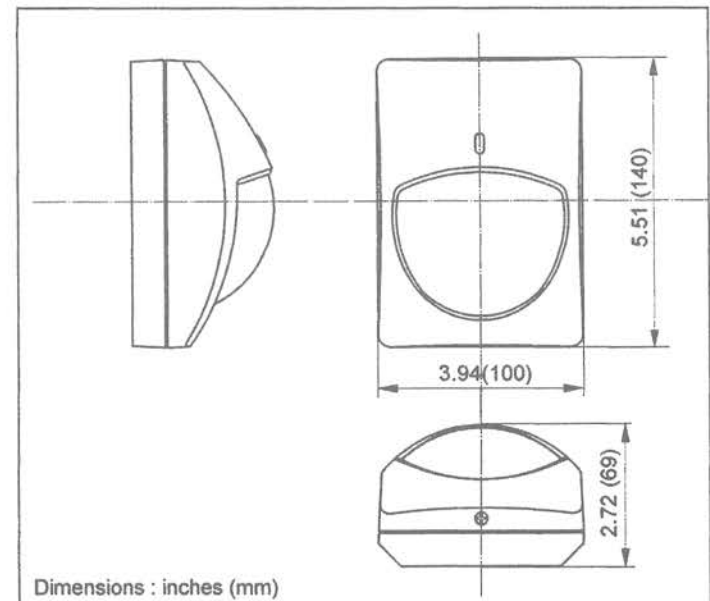

\*Specifications and design are subject to change without prior notice.



### NOTE

These units are designed to detect movement of an intruder and activate an alarm control panel. Being only part of a complete alarm system, we cannot accept responsibility for any damages or other consequences resulting from an intrusion. These products conform to the EMC Directive 2004/108/EC.

OPTEX CO., LTD. (JAPAN)  
 (ISO 9001 Certified)  
 (ISO 14001 Certified)  
 5-9-12, Ogoho-Otsu  
 Soga, 520-0101  
 JAPAN  
 TEL: +81-77-579-8570  
 FAX: +81-77-579-8199  
 URL: <http://www.optex.co.jp/>

OPTEX INCORPORATED (USA)  
 TEL: +1-800-998-0770  
 Tech: 800-906-7829  
 URL: <http://www.optex-america.com/>

OPTEX (EUROPE) LTD. (UK)  
 TEL: +44-1628-631000  
 URL: <http://www.optex-europe.com/>

OPTEX SECURITY SAS (FRANCE)  
 TEL: +33-437-69-69-68  
 URL: <http://www.optex-security.com/>

OPTEX SECURITY Sp.z o.o. (POLAND)  
 TEL: +48-22-998-05-65  
 URL: <http://www.optex.com.pl/>

OPTEX KOREA CO., LTD. (KOREA)  
 TEL: +82-2-719-5971  
 URL: <http://www.optexkorea.com/>

OPTEX (DONGGUAN) CO., LTD.  
 SHENZHEN OFFICE (CHINA)  
 TEL: +86-755-33362250  
 URL: <http://www.optexchina.com/>