



Power supply unit for fire systems used in building industry.
Declared performance: Fire safety.
Certificate of constancy of performance: 1438-CPR-0628
Certificate of admittance: 5222/2024
Conformity: EN 54-4:2001+ A1:2004 + A2:2007
EN 12101-10:2007 + AC:2007

USER MANUAL

EN

Edition: 5 from 22.01.2024

Supersedes edition: 4 from 21.12.2022

Power supplies EN54C-LCD series

v.1.1

**Power supplies for fire alarm systems and
smoke and heat control systems.**





GENERAL SAFETY RULES



Before installation, read the instruction manual to avoid errors that can damage the device and give you an electric shock.

- Before installation, cut off the voltage in the 230 V power-supply circuit.
- To switch power off, use an external switch, in which distance between contacts of all poles in disconnection state is not less than 3 mm.
- The shock protection circuit shall be done with a particular care: the yellow and green wire coat of the power cable should be connected to the terminal marked with the grounding symbol on the PSU enclosure. Operation of the PSU without the properly made and fully operational shock protection circuit is UNACCEPTABLE! It can cause damage to the equipment or an electric shock.
- Removed batteries should be stored in a designated collection point. Do not reverse polarity of batteries. Explosion hazard if a battery has been replaced by an incorrect type.
- Device should be transported without batteries. This has a direct impact on safety of user and device.
- Installing and connecting the power supply must be carried out without batteries.
- When connecting batteries to the power supply, pay particular attention to the correct polarity. If necessary, it is possible to permanently disconnect the battery from the power supply systems by removing the F_{BAT} fuse.
- The power supply is adapted to be connected to a power distribution network with an effectively earthed neutral conductor.
- Ensure a free, convection air flow around the enclosure. Do not cover the ventilation openings.

TABLE OF CONTENTS

1. PSU FEATURES.....	5
2. FUNCTIONAL REQUIREMENTS OF PSU.....	6
3. TECHNICAL DESCRIPTION.	7
3.1. GENERAL DESCRIPTION.....	7
3.2. BLOCK DIAGRAM.....	8
3.3. DESCRIPTION OF COMPONENTS AND POWER SUPPLY TERMINALS.....	8
4. INSTALLATION.....	11
4.1. REQUIREMENTS.....	11
4.2. INSTALLATION PROCEDURE.....	12
4.3. PROCEDURE FOR CHECKING POWER SUPPLY AT PLACE OF INSTALLATION.....	13
5. FUNCTIONS.....	14
5.1. TECHNICAL OUTPUTS.....	14
5.2. INPUT OF COLLECTIVE FAILURE: EXTi.....	15
5.3. INDICATION OF THE ENCLOSURE OPENING – TAMPER.....	16
5.4. PSU OVERLOAD.....	16
5.5. SHORT-CIRCUIT OF THE PSU OUTPUT.....	16
5.6. ADDITIONAL MODULES.....	16
5.6.1. <i>Extending the number of PSU outputs – EN54C-LB4 and EN54C-LB8 fuse modules.....</i>	<i>16</i>
5.6.2. <i>Cooperation with electric actuators – EN54C-LS4 and EN54C-LS8 sequential modules.....</i>	<i>17</i>
6. RESERVE POWER SUPPLY CIRCUIT.....	18
6.1. BATTERY DETECTION.....	18
6.2. PROTECTION AGAINST SHORT-CIRCUIT OF THE BATTERY TERMINALS.....	18
6.3. PROTECTION AGAINST REVERSE BATTERY CONNECTION.....	18
6.4. DEEP DISCHARGE BATTERY PROTECTION UVP.....	18
6.5. BATTERY TEST.....	18
6.6. MEASUREMENT OF THE RESISTANCE OF THE BATTERY CIRCUIT.....	18
6.7. BATTERY TEMPERATURE MEASUREMENT.....	18
6.8. STANDBY TIME.....	19
7. LCD DISPLAY – PREVIEW	20
7.1. CONTROL PANEL.....	20
7.2. FIRST RUN OF PSU – LANGUAGE SELECTION SCREEN.....	21
7.3. MAIN SCREEN OF LCD.....	21
7.4. INFORMATION DISPLAYED ON LCD PANEL.....	22
7.4.1. <i>Preview menu.....</i>	<i>22</i>
7.4.2. <i>LCD screen – current parameters </i>	<i>22</i>
7.4.3. <i>LCD screen – current failures </i>	<i>23</i>
7.4.4. <i>LCD screen – history of parameters </i>	<i>24</i>
7.4.5. <i>List of failure codes and information messages.....</i>	<i>25</i>
8. LCD DISPLAY – PSU SETTINGS.....	27
8.1. PASSWORD.....	27
8.1.1. <i>Entering the password.....</i>	<i>27</i>
8.1.2. <i>Changing password.....</i>	<i>28</i>
8.1.3. <i>Disabling the password.....</i>	<i>28</i>
8.1.4. <i>Resetting passwords.....</i>	<i>29</i>
8.1.5. <i>Keyboard lock.....</i>	<i>29</i>
8.2. PSU.....	31
8.2.1. <i>Battery test performance.....</i>	<i>31</i>
8.2.2. <i>Setting delay time for EPS output indicating 230 V AC power loss.....</i>	<i>33</i>
8.2.3. <i>Setting communication address – refers to cooperation with the interface.....</i>	<i>34</i>
8.2.4. <i>Setting transmission parameters – refers to cooperation with the interface.....</i>	<i>35</i>
8.3. CONTROL PANEL.....	36
8.3.1. <i>Setting display language.....</i>	<i>37</i>

8.3.2. <i>Setting date</i>	37
8.3.3. <i>Setting time</i>	38
8.3.4. <i>Setting backlight mode</i>	39
8.3.5. <i>Contrast setting</i>	40
8.3.6. <i>Blinking light indicating failure</i>	41
9. REMOTE MONITORING (OPTIONS)	42
9.1. ETHERNET NETWORK COMMUNICATION.....	42
9.2. RS485-ETHERNET NETWORK COMMUNICATION.....	42
9.3. „POWERSECURITY” WEB APPLICATION.....	44
10. TECHNICAL PARAMETERS.....	47
<i>Table 13. Electrical parameters</i>	47
<i>Table 14. Mechanical parameters</i>	49
<i>Table 15. Safety of use</i>	49
<i>Table 16. Operation parameters</i>	50
<i>Table 17. Recommended types and sections of installation cables</i>	50
11. TECHNICAL INSPECTIONS AND MAINTENANCE.	51
11.1. BATTERY REPLACEMENT OF LCD PANEL.....	51

1. PSU features.

- Compliant with requirements of EN 54-4:1997+AC:1999+A1:2002+A2:2006 EN 12101-10:2005+AC:2007
 - 27,6 V DC uninterruptible power supply
 - available versions with **2 A / 3 A / 5 A / 10 A** current efficiencies
 - available versions with space for **7 Ah – 65 Ah** batteries
 - independently protected outputs AUX1 and AUX2
 - high efficiency (up to 89%)
 - low level of voltage ripple
 - microprocessor-based automation system
 - measurement of resistance of battery circuit
 - automatic temperature-compensated charging
 - automatic battery test
 - two-stage battery charging process
 - accelerated battery charging
 - monitoring of continuity of battery circuit
 - monitoring of battery voltage
 - monitoring of charging and maintenance of batteries
 - deep discharge battery protection (UVP)
 - battery overcharge protection
 - LoB low battery voltage indication
 - battery output protection against short-circuit and reverse connection
 - output voltage control
 - fuse monitoring of AUX1 and AUX2 outputs
 - „SERIAL” communication port with implemented MODBUS RTU protocol and TCP/IP – a list of registers is available
 - cooperation with EN54C-LB4 and EN54C-LB8 fuse modules (optional equipment)
 - cooperation with EN54C-LS4 and EN54C-LS8 sequential modules (optional equipment)
 - relay output of collective failure ALARM
 - EPS relay output indicating 230 V power loss
 - EXTi input of external failure
 - protections:
 - SCP short-circuit protection
 - OLP overload protection
 - OVP overvoltage protection
 - surge protection
 - antisabotage protection – Tamper
 - closing enclosure – lock
 - convection cooling (forced only in EN54C-10AxxLCD)
 - Warranty – 3 years
- MOREOVER, IN THE VERSION WITH A LCD AND ETHERNET COMMUNICATION**
- optical indication – LCD display
 - display of electrical parameters, e.g. voltage, current, resistance of battery circuit readings
 - failure indication
 - PSU settings adjusted from panel’s level
 - adjustable delay for 230 V power loss indication
 - 2 levels of password protected access
 - operation memory of PSU
 - failure memory
 - a real-time clock (RTC) with battery backup
 - remote monitoring
 - Ethernet communication or RS485 (option)
 - embedded PowerSecurity web application
 - preview of the operating parameters: voltages, currents, temperature and resistance of the battery circuit
 - PSU work history chart from a period of more than 100 days: voltages, currents and resistance of the battery circuit
 - battery operating temperature readings from period up to 5 years
 - event log of up to 2048 power supply failures
 - SSL email encryption
 - remote battery test

2. Functional requirements of PSU.

The buffer power supplies for fire alarm systems has been designed in accordance with the following standards:

- EN 54-4:1997+AC:1999+A1:2002+A2:2006 Fire detection and fire alarm systems
- EN 12101-10:2005+AC:2007 Smoke and heat control systems

Functional requirements	Requirements according to standards	Power supplies EN54C-LCD series
Two independent power sources	YES	YES
EPS network failure indication	YES	YES
Two independent power supply outputs protected against short circuits	YES	YES
Temperature compensation of the battery charging voltage	YES	YES
Measurement of the resistance of the battery circuit	YES	YES
LoB low battery voltage indication	YES	YES
Recharging battery to 80% of rated capacity within 24 hours	YES	YES
Protection against deep battery discharge	YES	YES
Protection against short-circuit at the battery terminals	YES	YES
Charging circuit failure Indication	YES	YES
Short-circuit protection	YES	YES
Overload protection	YES	YES
Output of collective failure ALARM	YES	YES
EPS technical output	YES	YES
Low output voltage indication	-	YES
High output voltage indication	-	YES
Power supply failure indication	-	YES
Protection against surges	-	YES
Input of external failure indication EXTi	-	YES
Tamper switch unwanted enclosure opening	-	YES

3. Technical description.

3.1. General description.

The buffer power supplies has been designed for an uninterrupted supply of fire alarm systems, smoke and heat control systems, fire protection equipment and fire automatics requiring stabilized voltage of 24 V DC ($\pm 15\%$). The power supplies are fitted with two independently protected AUX1 and AUX2 outputs, which provide a voltage of 27,6 V DC and the total current efficiency depending on the version:

Power supply model	Battery	Continuous operation I _{max a}	Instantaneous operation I _{max b}
EN54C-2A7LCD	7 Ah	1,6 A	2 A
EN54C-2A17LCD	17 Ah	1,2 A	
EN54C-3A7LCD	7 Ah	2,6 A	3 A
EN54C-3A17LCD	17 Ah	2,2 A	
EN54C-3A28LCD	28 Ah	1,8 A	
EN54C-5A7LCD	7 Ah	4,6 A	5 A
EN54C-5A17LCD	17 Ah	4,2 A	
EN54C-5A28LCD	28 Ah	3,8 A	
EN54C-5A40LCD	40 Ah	3,2 A	
EN54C-5A65LCD	65 Ah	2,4 A	
EN54C-10A17LCD	17 Ah	9,2 A	10 A
EN54C-10A28LCD	28 Ah	8,8 A	
EN54C-10A40LCD	40 Ah	8,2 A	
EN54C-10A65LCD	65 Ah	7,4 A	

In case of power loss, the PSU switches to battery power, providing uninterruptible power supply.

The power supply unit is housed in a metal enclosure (color red RAL 3001) with space for battery.

Power supply units works with maintenance-free lead acid batteries made with AGM technology or gel technology.

3.2. Block diagram.

The power supplies has been manufactured based on a high-efficiency system of AC/DC converter. Applied microprocessor circuit is responsible for the full diagnostics of the PSU parameters and batteries. The figure below shows a flowchart of the power supply, along with selected functional blocks which are essential for the proper functioning of the unit.

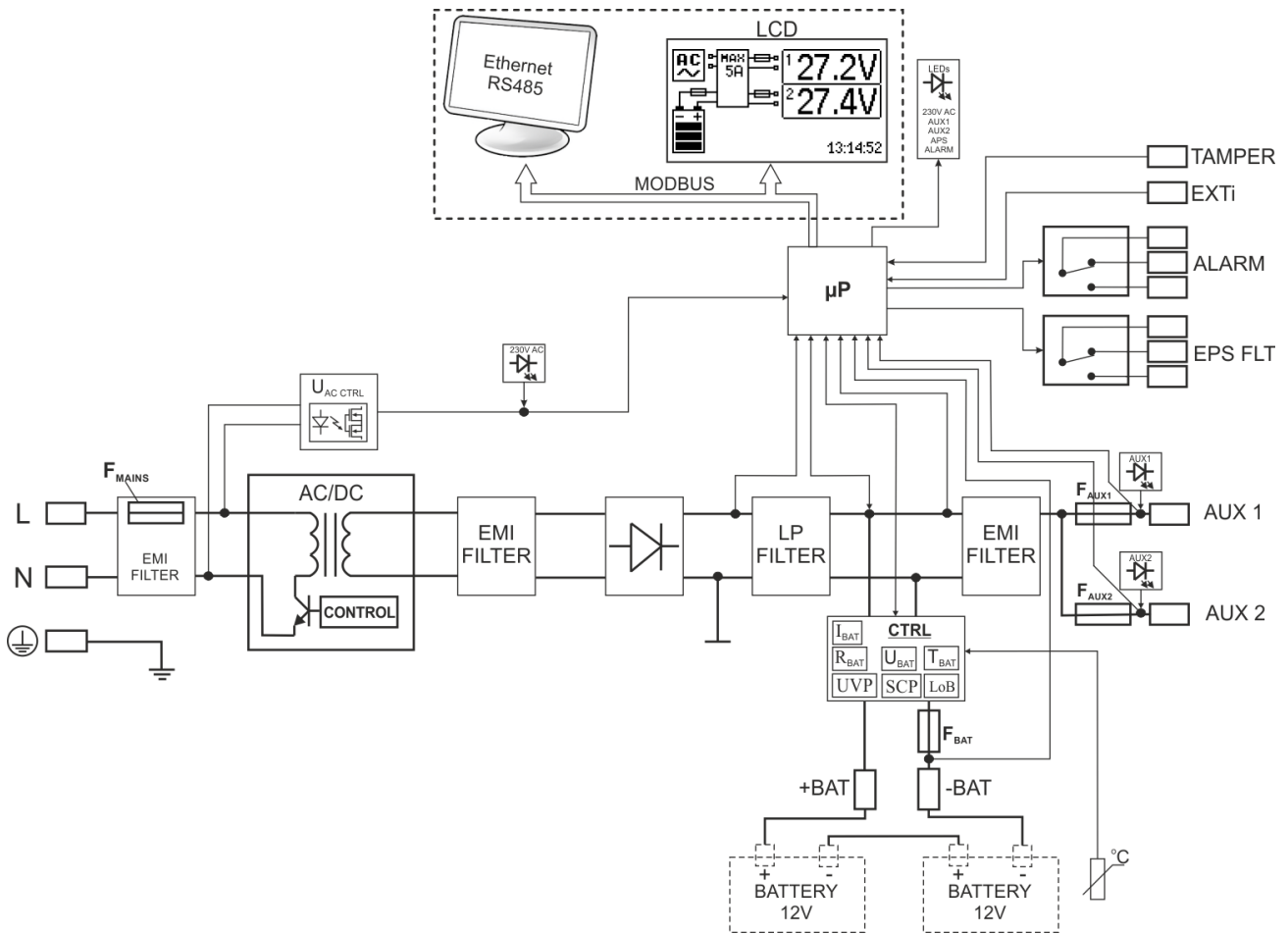

Fig. 1. PSU block diagram.

3.3. Description of components and power supply terminals.

Table 1. Elements of PSU (Fig. 2).

Component No.	Description
①	230 V supply connector with a terminal for connection of a protective conductor
②	<p>Terminals:</p> <ul style="list-style-type: none"> TEMP – input of the battery temperature sensor TAMPER – input of the microswitch tamper Closed input = no indication Open input = alarm ALARM – technical output of collective failure of the PSU - relay type EPS – technical output of AC power failure indication open = AC power failure closed = AC power - O.K. EXTi – external failure input closed input = no indication open input = alarm +BAT- – terminals for connecting the battery +AUX1- – AUX1 power output (- AUX=GND) +AUX2- – AUX2 power output (- AUX=GND) <p>CAUTION! In Fig. 2 the set of contacts shows a potential-free status of the relay, which corresponds to power supply failure.</p>

③	Fuses: F_{BAT} – fuse in the battery circuit, F_{AUX1} – fuse in the AUX1 output circuit, F_{AUX2} – fuse in the AUX2 output circuit, The fuse values are given in table 12 – "Electrical parameters".
④	LEDs – optical indication: 230 V AC – voltage in 230 V AC circuit APS – battery failure ALARM – collective failure AUX1 – AUX1 output voltage (at the AUX1 connector) AUX2 – AUX2 output voltage (at the AUX2 connector)
⑤	Battery temperature sensor
⑥	Battery connectors; positive: +BAT = red, negative: - BAT = black
⑦	LCD connector
⑧	Communication interface connector

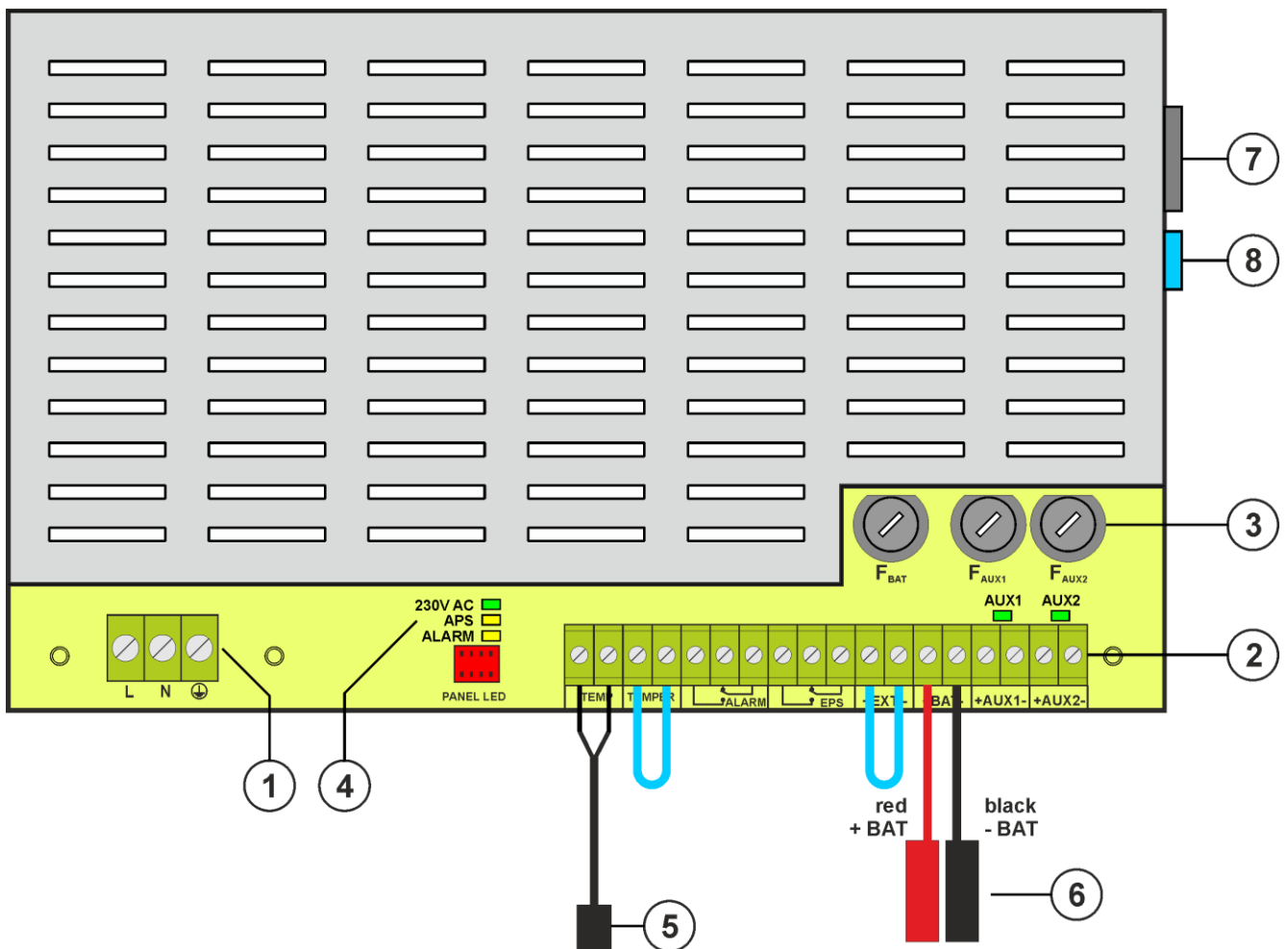

Fig. 2. View of power supply module based on EN54C-2A7LCD.

Table 2. Elements of PSU (Fig. 3).

Component No.	Description
①	PSU (tab. 1, Fig. 2)
②	Battery temperature sensor
③	Battery connectors; positive: +BAT = red, negative: - BAT = black
④	Place to install fuse module: INTE-C, INTR-C, INTRE-C
⑤	A place for installation of additional modules
⑥	TAMPER; microswitch (contacts) of antisabotage protection (NC)
⑦	Fitting battery
⑧	Embossing for cable gland
⑨	Embossings for concealed wires
⑩	Lock

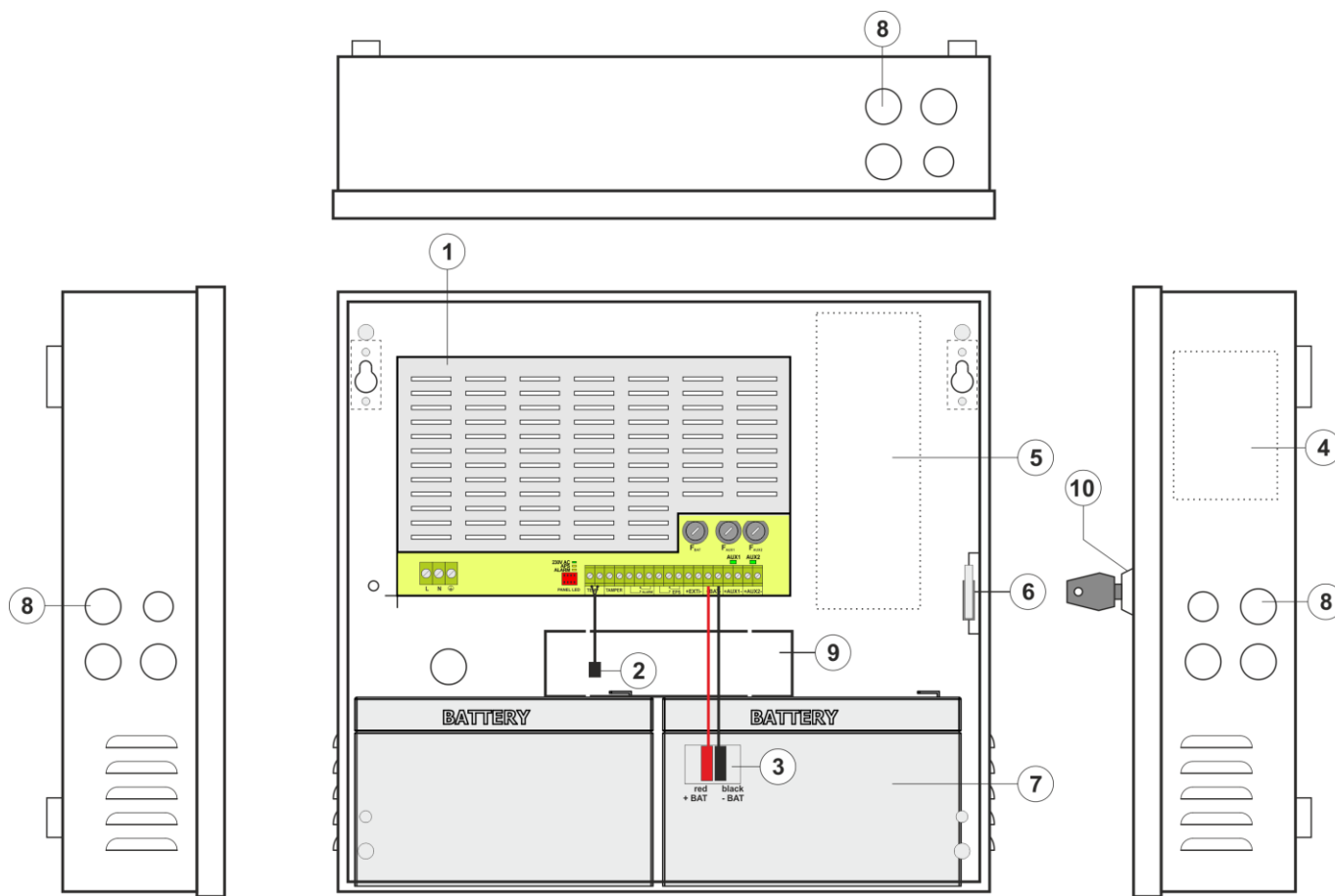

Fig. 3. View of power supply based on EN54C-2A7LCD

4. Installation.

4.1. Requirements.

PSU is to be mounted by a qualified installer, holding relevant permits and licenses (applicable and required for a given country) to connect (interfere) with ~230 V mains supply.

As the power supply is designed for a continuous operation and is not equipped with a power-switch, therefore, an appropriate overload protection in the power supply circuit should be provided. Moreover, the user should be informed how to disconnect the power supply unit from the mains supply (usually by assigning an appropriate fuse in the fuse box). One switch should only protect one power supply. The electrical system shall follow valid standards and regulations. The power supply should operate in a vertical position in order to provide free and convectional air flow through ventilating holes of the casing.

As the PSU cyclically runs a periodic battery test, during which the resistance in the battery circuit is measured, pay attention to the proper connection of cables to the terminals. Installation cables should be firmly connected to the battery side terminals and to the power supply connector. If necessary, it is possible to permanently disconnect the battery from the power supply systems by removing the F_{BAT} fuse.

The side walls of the housing include the embossings, which should be used to carry out installation cables. Use a blunt instrument to make an opening for cable gland from the outside of the housing. Then, carefully mount the cable gland, protecting the PSU from water penetration, in the opening.

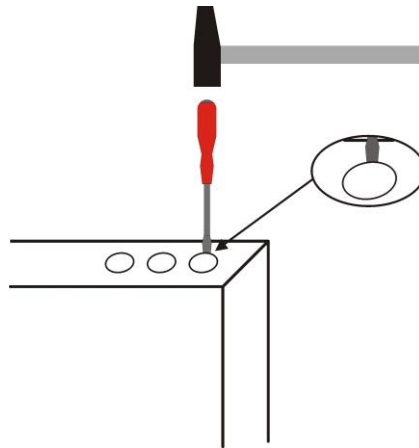

Fig. 4. The method of forming an opening for cable gland.

The PSU is fitted with PG9 and PG11 cable glands. Gland size should be chosen depending on the cross-section of the cable. Single cable gland can be used for only one wire.

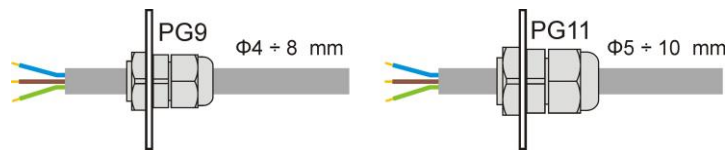

Fig. 5. Recommended types and sections of installation cables PG9 and PG11 for cable glands.

4.2. Installation procedure.



CAUTION!

Before installation, cut off the voltage in the 230 V power-supply circuit. To switch power off, use an external switch, in which the distance between the contacts of all poles in the disconnection state is not less than 3mm.

It is required to install an installation switch with a nominal current of 6 A in the power supply circuits outside the power supply unit.

1. Mount the PSU in a selected location with use of special metal expansion bolts. Do not use PVC dowels.
2. Connect power cables ~230 V to L-N clips of PSU. Cable length inside housing should not exceed 10cm.

Connect ground wire to terminal marked with grounding  symbol in enclosure. Use a three-core cable (with a yellow and green protection wire) to make connection. Wires should be deisolated to a length of 7.2mm.







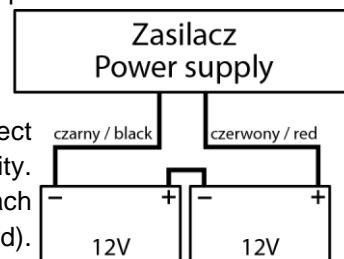



Shock protection circuit shall be done with a particular care: yellow and green wire coat of power cable should be connected to terminal marked with grounding  symbol on PSU enclosure. Operation of PSU without properly made and fully operational shock protection circuit is UNACCEPTABLE! It can cause damage to equipment or an electric shock.

3. Connect the receivers' cables to the AUX1 and AUX2 output terminals on the PSU board.
4. If needed, connect the cables from the devices to the technical inputs and outputs:
 - ALARM; technical output of collective failure of the PSU
 - EPS; technical output indication of 230 V power collapse
 - EXTi; input of external failure
5. Install the batteries in a designated area of the enclosure (see Fig. 3). Connect the batteries with the PSU paying special attention to the correct polarity. Batteries must be connected in series using the special cable (included). Attach the temperature sensor to any of the batteries with mounting tape (included). Place the temperature sensor between the batteries.
6. Switch on the ~230 V supply. The corresponding LEDs on the power supply PCB should be ON: 230 V AC green and AUX1, AUX2.
7. Check the current consumption of the receivers, taking into account the battery charging current, so as not to exceed the total current efficiency of the PSU (see section 3.1).
8. Once the tests are completed, close the enclosure.



4.3. Procedure for checking power supply at place of installation.

- 1 Check the indication displayed on the front panel of the power supply unit:
 - a) 230 V AC LED  should remain lit to indicate the presence of the mains supply voltage.
 - b) LEDs AUX 1  and AUX 2  should remain lit to indicate presence of supply voltage.
- 2 Check the output voltage after 230 V power failure.
 - a) Simulate the lack of 230 V mains voltage by disconnecting the main circuit breaker.
 - b) 230 V AC LED  should go out.
 - c) LEDs AUX 1  and AUX 2  should remain lit to indicate the presence of output voltage.
 - d) LED ALARM LED  will start blinking.
 - e) EPS technical output and ALARM will change to the opposite status after 10 seconds / 1 min / 10 mins / 30 mins, depending on the "EPS" parameter set in the PSU configuration menu (default setting: 10 seconds).
 - f) Turn on the 230 V mains voltage again. Indication should return to the initial status from point 1 after a few seconds.
- 3 Check whether the lack of continuity in the battery circuit is properly indicated.
 - a) During normal PSU operation (230 V mains voltage on), disconnect the battery circuit by disconnecting the F_{BAT} fuse.
 - b) Within 5 minutes the PSU will start signaling a failure in the battery circuit.
 - c) ALARM LED  will start blinking.
 - d) ALARM technical output will change status into opposite.
 - e) Turn on the FBAT fuse in the battery circuit again.
 - i) The power supply should return to normal operation, indicating the initial status, within 5 minutes after the battery test is completed.

5. Functions

5.1. Technical outputs.

The power supply is fitted with relay indication outputs changing state upon the occurrence of a specific event.

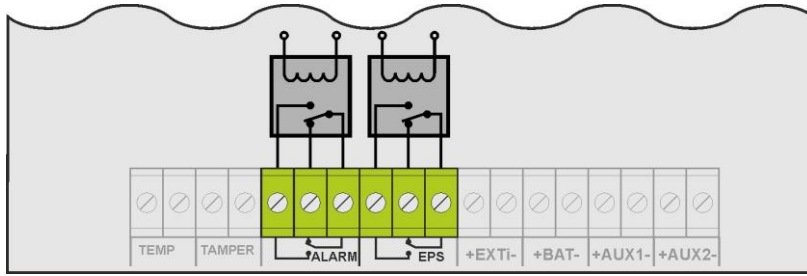

Fig. 6. Electrical diagram of relay outputs.

- **EPS – output indicating 230 V power loss.**

The output indicates 230 V power loss. Under normal status – with the 230 V supply on, the output is closed. In case of power failure, the PSU will switch the output into the open position after a time 10 s. (factory settings).

In case of a PSU version with a LCD, this time can be changed from the level of the „EPS Output Delay” menu (see Section 8.2.2).

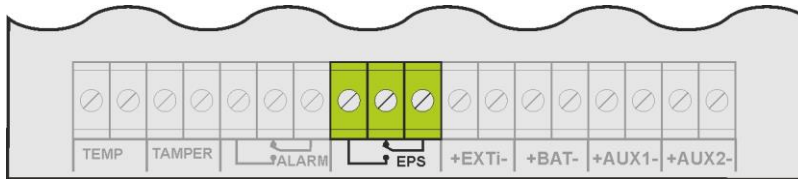

Fig. 7. EPS technical output.



CAUTION! In Figure the set of contacts shows a potential-free status of the relay, which corresponds to power supply failure.

- **ALARM – technical output of collective failure indication.**

Output indicating collective failure. In the case of 230 V power failure, battery circuit failure, PSU failure, or EXTi input activation, the collective failure signal ALARM will be generated.

Failure can be triggered by the following events:

- 230V power failure AC
- faulty batteries
- undercharged batteries
- disconnected batteries
- high resistance of the battery circuit
- no continuity in the battery circuit
- $U_{AUX1, AUX2}$ output voltage below 26 V
- $U_{AUX1, AUX2}$ output voltage over 29,2 V
- battery charging circuit failure
- blown F_{AUX1} or F_{AUX2} fuse
- PSU overload
- to high battery temperature (>65°C)
- temperature sensor failure, $t < -20^{\circ}C$ or $t > 80^{\circ}C$
- enclosure opening – TAMPER
- internal damage of the PSU



Fig. 8. Technical output ALARM.



CAUTION! In Figure set of contacts shows a potential-free status of relay, which corresponds to power supply failure.

5.2. Input of collective failure: EXTi.

The EXTi (external input) technical input indicating collective failure is intended for additional, external devices that generate the failure signal. Disconnection of the EXTi terminals will cause a failure of the PSU and generate a failure signal at the ALARM output.

The EXTi technical input is not galvanically isolated from the power supply. The „minus” terminal is connected to the power supply.

The connection of external devices to the EXTi input is shown in the electrical diagram below.

Relay outputs or „open collector” signal outputs can be used as the signal source.

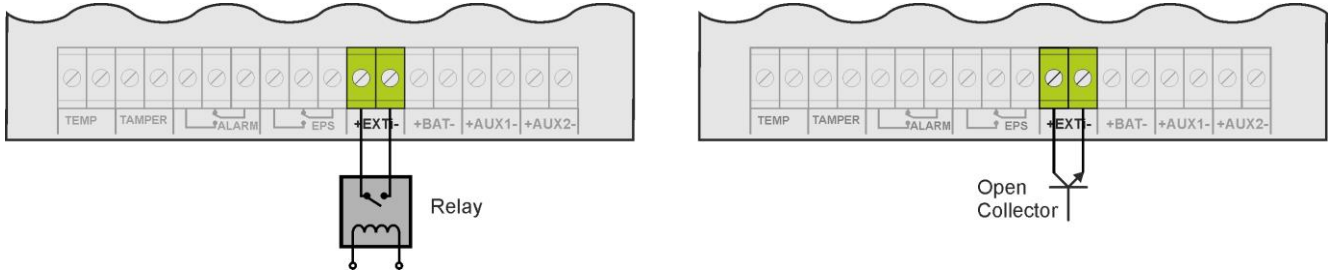

Fig. 9. Connections to the EXTi input.

The EXTi input has been adjusted to work with EN54C-LB4 and EN54C-LB8 fuse modules generating a failure signal in case of a fuse fault in any of output sections (see section 5.6). To guarantee a correct cooperation between the fuse module and the EXTi input, the connections shall be made as presented in the diagram below.

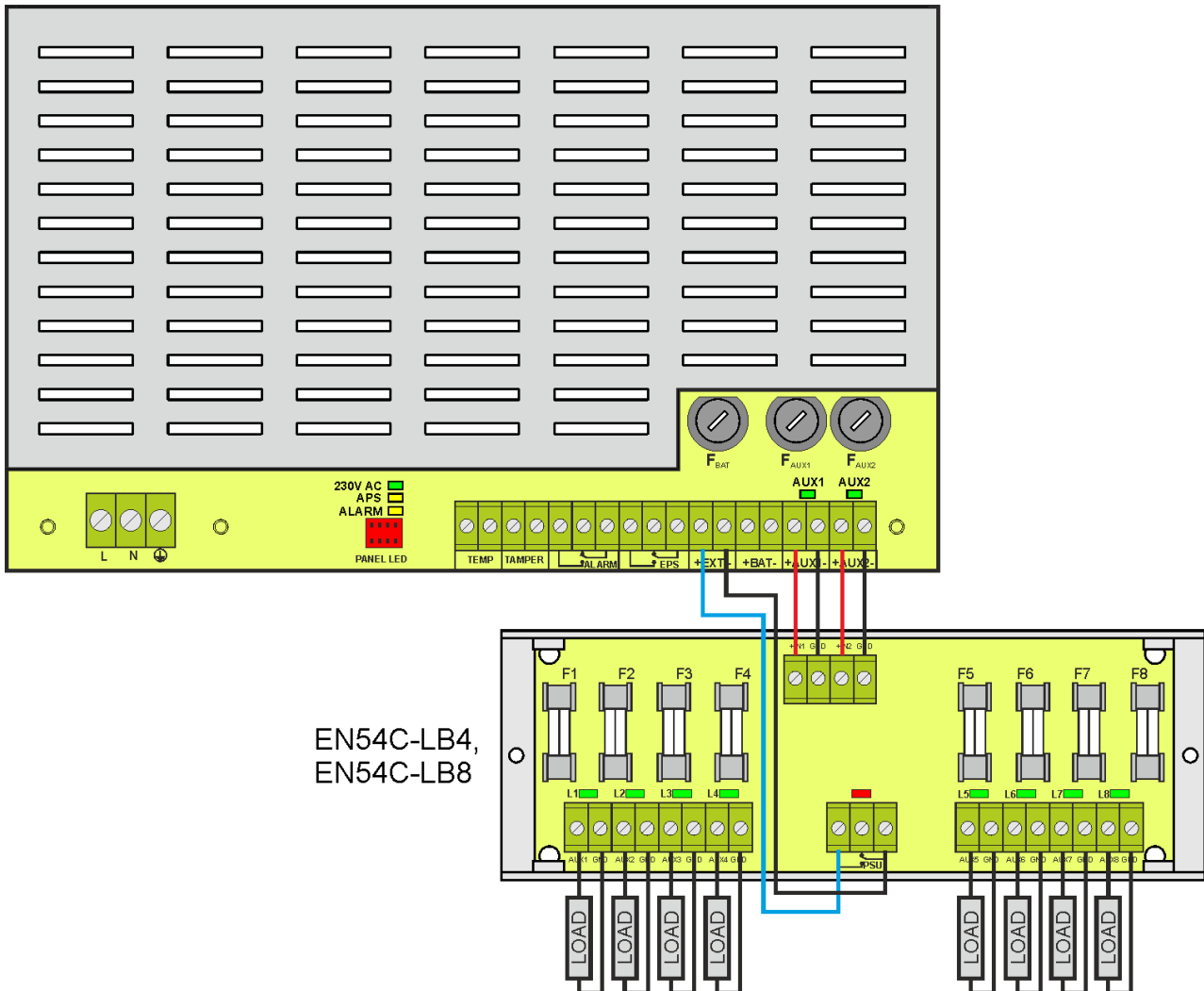

Fig. 10. Example of a connection with fuse module EN54C-LB8.

5.3. Indication of the enclosure opening – TAMPER.

The PSU is fitted with the microswitch tamper indicating enclosure opening.

The tamper cable is not connected to the terminal in the factory settings. In order to activate tamper, remove the jumper from tamper terminal and plug in the tamper cable. Each opening the enclosure will generate a failure signal at the ALARM technical output.

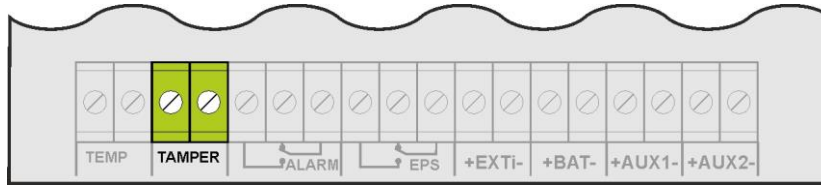

Fig. 11. TAMPER technical output.

5.4. PSU overload.

If the output overload occurs during the PSU operation, the PSU will limit the battery charging current for 1 minute. If, after this time, the overload is removed, the normal charging mode will be restored.

5.5. Short-circuit of the PSU output.

In case of short-circuit of the AUX1 or AUX2 output, one of the fuses - F_{AUX1} or F_{AUX2} – becomes permanently blown. The restoration of the voltage at the output requires the replacement of the fuse.

During a short circuit, the PSU failure is indicated by the ALARM LED and a collective failure signal at the ALARM output.

5.6. Additional modules.

The PSU can be used with optional fuse or sequential modules that will increase its functionality in the case of extended fire protection systems. A place to mount additional modules has been provided inside the power supply housing.



When installing the fuse module in the power supply, take into account the current consumption for the power supply's own needs, which is used for the calculation of the standby time (see section 6.8).

5.6.1. Extending the number of PSU outputs – EN54C-LB4 and EN54C-LB8 fuse modules.

The PSU is fitted with two independently protected outputs for connecting AUX1 and AUX2 receivers. If more receivers are connected to the power supply, it is recommended to secure each of them with an independent fuse. Such a solution will allow avoiding the failure of the entire system in the event of a fault (short circuit on the line) of any of the connected receivers.

The possibility of such protection is provided by the optional EN54C-LB4 (4-channel) or EN54C-LB8 (8-channel) fuse module, for which the mounting location is provided inside the housing (Fig. 3).

Figure 10 shows the connection of the power supply, the fuse module, and the receivers (LOAD).

The fuse module, depending on the version, allows connecting 4 or 8 receivers to the power supply.

Output state is indicated by green LEDs.

The blown strip fuse is signaled as follows:

- switching off the appropriate LED: L1 for AUX1 etc.
- the red PSU LED lights up
- switching the PSU relay output into a no-voltage state (contacts as in Figure 10)

In addition, the blown fuse signal is passed to the EXTi input of the collective power supply failure, and the PSU reports a failure at the ALARM output.

The relay output of the PSU fuse strip can be used for remote control, e.g. external optical indication.

Detailed information may be found in the operation manual of the module.

5.6.2. Cooperation with electric actuators – EN54C-LS4 and EN54C-LS8 sequential modules.

The sequential modules are designed for use with electric actuators without return spring (EN54C-LS4) and with electric actuators with return spring (EN54C-LS8) used for fire dampers and smoke vents. These devices are used in fire alarm systems and smoke and heat control systems.

When switching on the electric actuator, a short-term current surge, exceeding its rated current, may occur. If multiple electric actuators are connected, the above-mentioned surge current poses a risk of incorrect operation of the power supply (e.g. triggering the protection of output circuit), despite not exceeding the current capacity of the power supply.

The sequential switching module causes the receivers connected to its outputs to be sequentially switched, with a delay of 100 ms. Thanks to this solution, the surge current is reduced to the value ensuring correct operation of the power supply. Thus, it enables safe connection of additional actuators. All outputs are independently protected by PTC polymer fuses and have LED diodes signaling the activation of each output.

The module is controlled by a control device (e.g. a CSP control panel) configuring the resistance at the INPUT connector. The technical output of failure signals failures at the parametric INPUT input. Detailed information may be found in the operation manual of the module.

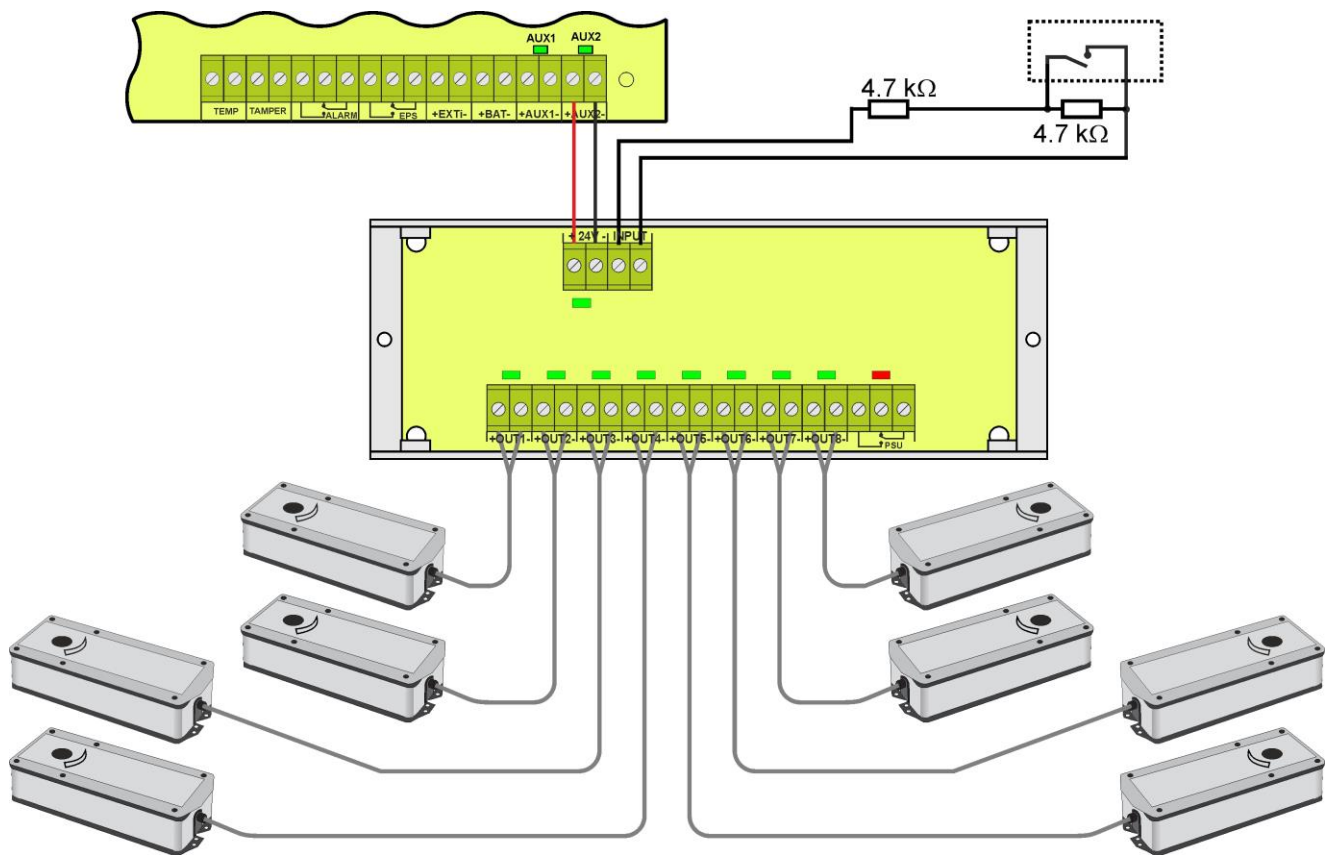

Fig. 12. Example of connection of the EN54C-LS8 sequential module with actuators with return spring.

6. Reserve power supply circuit.

The PSU is fitted with intelligent circuits: battery charging circuit with the function of the accelerated charging and battery control, which main task is to monitor the condition of the batteries and the connections in the circuit.

If the controller detects a power failure in the battery circuit, appropriate indication and change of the ALARM technical output.

6.1. Battery detection.

The control unit of the PSU checks the voltage at the battery terminals and, depending on the measured values, determines the appropriate reaction:

- U_{BAT} below 4 V – batteries not connected to the PSU circuits
- $U_{BAT} = 4$ to 20 V – faulty batteries
- U_{BAT} over 20 V – batteries connected to the PSU circuits

6.2. Protection against short-circuit of the battery terminals.

The PSU is fitted with the circuit protecting against short-circuit of the battery terminals. In case of short circuit, control circuit immediately disconnects the batteries from the rest of the power supply circuit, so the loss of output voltage on power supply outputs is not observed. Automatic reconnection of the batteries to the PSU's circuits is only possible after the removal of the short-circuit and correct connection of the circuits.

6.3. Protection against reverse battery connection.

The PSU is protected against reverse connection of the battery terminals. In case of incorrect connection, the F_{BAT} fuse in the battery circuit becomes blown. The return to normal operation is possible only after replacing the fuse and correct connection of the batteries.

6.4. Deep discharge battery protection UVP.

The PSU is fitted with the disconnection system and the battery discharge indication. If the voltage at the battery terminals drops below $20 V \pm 0.2 V$ during battery-assisted operation, acoustic indication will be activated and the batteries will be disconnected within 15s.

The batteries are reconnected to the power supply unit automatically once the 230 V mains supply is restored.

6.5. Battery test.

The PSU runs battery test every 5 minutes. During testing, the control unit of the PSU measures the electrical parameters according to the implemented measuring method.

A negative result occurs when the:

- battery circuit continuity is interrupted,
- resistance in the battery circuit increases above 300 m Ω
- terminal voltage drops below 24 V.

The battery test will also be automatically locked when the PSU is in the operating mode, in which the battery test is impossible. Such condition occurs, for example, during battery assisted operation.

6.6. Measurement of the resistance of the battery circuit.

The PSU is checking the resistance in the battery circuit. During the measurement, the PSU driver takes into account the key parameters in the circuit, and once the limit value of 300m ohms is exceeded, a failure is indicated.

A failure may indicate considerable wear or loose cables connecting the batteries.

6.7. Battery temperature measurement.

Temperature measurement and compensation of the battery charging voltage can extend the life of the batteries.

The PSU has a temperature sensor to monitor the temperature parameters of installed batteries. It is recommended to place the temperature sensor between the batteries. Be careful not to damage the sensor when moving the batteries.

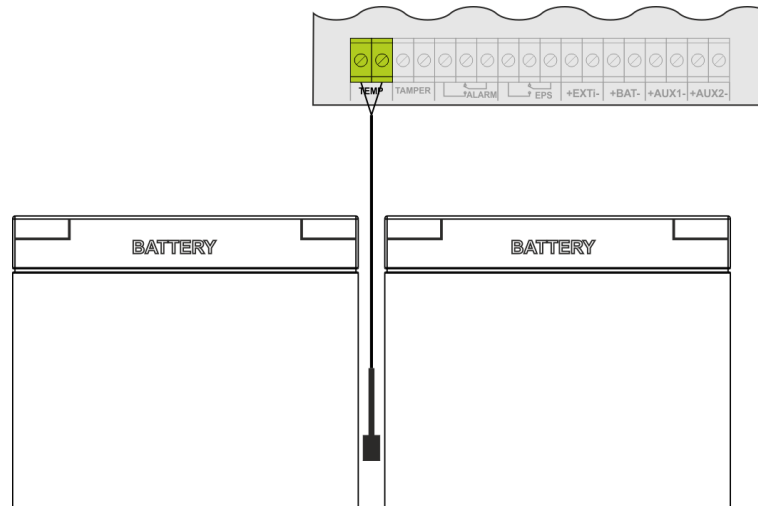

Fig. 13. Mounting of the temperature sensor.

The PSU has a separate space in the internal memory, used for recording of the registered battery temperature. The recording cycle is performed in 6-hour intervals, enabling temperature registration for a period of 5 years. With such an extended registration period, the user is able to control the temperature fluctuation range and to determine its impact on the life of the batteries.



The nominal battery operating temperature recommended by many manufacturers is 25°C. Working at elevated temperatures will significantly shorten the battery lifetime. The service life is reduced by half for each sustained temperature rise of 8°C above the nominal temperature. This means that the battery lifespan, when operated at 33°C, can be decreased by 50%!

6.8. Standby time.

Battery-assisted operating depends on battery capacity, charging level and load current. To maintain an appropriate standby time, current drawn from the PSU in battery mode should be limited.

Required, minimum battery capacity to work with the PSU can be calculated with the following formula:

$$Q_{AKU} = 1.25 \cdot \{ (I_d + I_z) \cdot T_d + (I_a + I_z) \cdot T_a + 0.05 I_c \}$$

where:

- Q_{AKU} – the minimum battery capacity [Ah]
- 1.25 – the factor related to the decrease in battery capacity due to aging
- I_d – the current drawn by the load during inspection [A]
- I_z – PSU current consumption (including optional modules) [A] (Table 12)
- T_d – required inspection time [h]
- I_a – the current drawn by the load during an alarm [A]
- T_a – alarm duration [h]
- I_c – short-term output current

7. LCD display – preview

Table 3. Factory settings of PSU.

Indication time of EPS network loss	10 s	section 8.2.2
Acoustic indication	1	section 8.2.3
Transmission	115.2k 8E1	section 8.2.4
Highlighting	Constant – 50%	section 8.3.4
Blinking light indicating failure	ON	section 8.3.6
Passwords:		section 8.1
– user's	1111	
– installer's	1234	

7.1. Control panel.

The PSU features a panel with buttons and LCD display, enabling reading of all the available electrical parameters. The panel buttons are used to select and confirm the parameters, which should be displayed.

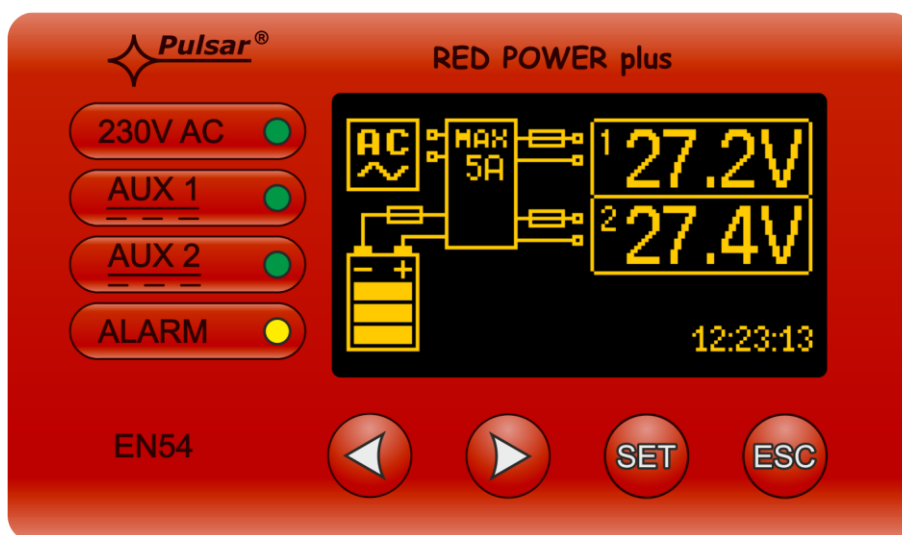

Fig. 14. Control panel.

Table 4. Description of buttons and LEDs of LCD panel.

	<ul style="list-style-type: none"> – move cursor on display – next screen selection
	– selection approval
	<ul style="list-style-type: none"> – leaving editing mode without changing values – selection approval
	– green LED indicating 230 V power
	– green LED AUX1 indicating power at AUX1 output of PSU
	– green LED AUX2 indicating power at AUX2 output of PSU
	– yellow LED ALARM indicating collective failure

7.2. First run of PSU – language selection screen.

During first run of PSU, language selection screen will be displayed. Use „<” or „>” buttons to select available languages.



Fig. 15. Language selection screen.

After selecting appropriate language, confirm by pressing „SET” button. Main screen will be displayed..

If language selection is not done, language selection screen will be displayed on next startup. If choice has already been made, language selection can be done as explained in section 8.3.1.



To facilitate the user's selection of the language of messages, the PSU enables calling up a menu on the main screen, displaying all available languages. To this end, press the arrow keys „<” and „>” on the front panel of the PSU simultaneously and hold them for a minimum of 5 seconds.

7.3. Main screen of LCD.

Main screen of LCD displays basic electrical parameters and indicates current status of power supply

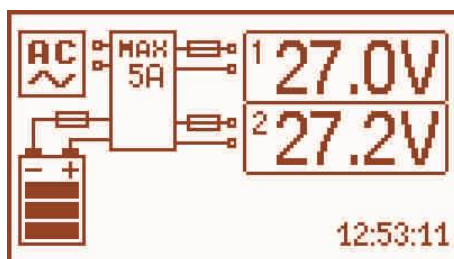

Fig. 16. Main screen of LCD.



The resolution of voltage and current measurement is 0.1 V and 0.1 A, respectively. The displayed values of voltages and currents should be treated with caution; if a greater accuracy is required, use a multimeter.

Table 5. Description of main screen symbols.

Screen field	Operating status	Failure status
	Indicating presence of supply of 230 V	Blinking „AC” symbol
	Information on the current voltage on the AUX1 and AUX2 outputs.	Parameter, which value has been exceeded, is blinking
	Information about current state of battery charge	The battery pictogram is flashing
	The value within the symbol indicates the maximum capacity of the PSU	Blinking warning symbol is displayed
	Signal of the status of fuses	Fuse icon – blinking
		Clock

7.4. Information displayed on LCD panel.

7.4.1. Preview menu.

Pressing „ESC” button at bottom of display starts preview menu, allowing to choose one of four available PSU screens..
Use „<” or „>” buttons to choose a proper screen and press „SET” button to confirm.



– current parameters of PSU
(see section 7.4.2)

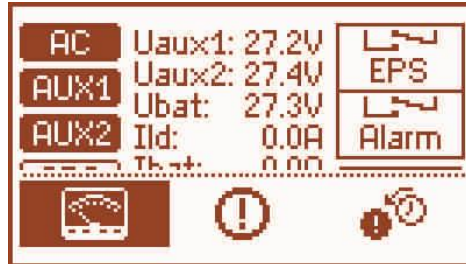

– current failures of PSU
(see section 7.4.3)



– event log
(see section 7.4.5)











7.4.2. LCD screen – current parameters

To set screen, press „ESC” button, use „<” or „>” buttons to choose icon and press „SET” button to confirm.
Screen displays electrical parameters and status of technical outputs during operation. Illumination of an element informs about an activation and reflects status of LEDs on PCB of PSU (see Table1, [4])..
The fields marked as EPS and ALARM show the current position of the relay contacts on technical outputs



Fig. 17. LCD panel – PSU parameters.

Table 6. Description of screen symbols - current parameters of PSU.

Screen field	Description	Additional information
	– ~230 V power ON (highlighted = present mains supply 230 V)	see section 8.2.2
	– indication power at AUX1 output (highlighted = present voltage at AUX1 output)	
	– indication power at AUX2 output (highlighted = present voltage at AUX2 output)	
	– indicates battery failure (highlighted = battery failure)	sections: 7.4.5 5.1
	– Signal of a collective failure of the PSU (highlighted = failure)	sections: 7.4.5 5.1
Uaux1: 27.2V Uaux2: 27.4V Ubat: 27.3V Ild: 0.0A Ibat: 0.0A Rbat: 64mΩ Tbat: 26°C	Current electrical parameters of PSU: U_{aux1} – AUX1 output voltage U_{aux2} – AUX2 output voltage U_{bat} – battery voltage I_{ld} – battery charging current I_{bat} – battery discharge current R_{bat} – resistance of battery circuit T_{bat} – battery temperature	sections: 7.4.2
   	Status of technical outputs: EPS – indicating presence of AC voltage open = AC power failure closed = AC power – O.K. ALARM – sygnalizacja awarii zbiorczej CAUTION! Set of contacts shows a potential-free status of relay, which corresponds to power supply failure. EXTi – EXTi input status indication (highlighted = EXTi input activated) TAMPER – Status of TAMPER input (highlighted = input activated)	sections: 7.4.5 5.1

7.4.3. LCD screen – current failures

In case of abnormal electrical parameters during operation, PSU will indicate a failure by displaying a message on LCD, turning on red LED on panel, activating acoustic indication (if enabled) and changing status of a dedicated technical output..



Fig. 18. Message indicating blown fuse at AUX1 output.

At a given time, multiple failures can occur. To check which faults are indicated, choose current failures of PSU screen.

To do that, press „ESC” button, use „<” or „>” buttons to choose  icon and press „SET” button to confirm



Fig. 19. LCD screen – current failures of PSU.

Screen displays codes and descriptions of failures. Display order of failures is arranged by priority of importance. First failures in display order are of highest priority.

7.4.4. LCD screen – history of parameters

The user is able to check the malfunctions formerly signalled by the PSU. History of events screen enables overviewing events recorded by internal diagnostic system. Internal memory can store up to 2048 events, carrying information about fault type, time of occurrence and the values of other electrical parameters.

To choose the history of events screen, press the „ESC” button, use the „<” or „>” buttons to choose the icon and press the „SET” button to confirm.



Fig. 20. History of events screen.

In order to preview history of events, use „<” or „>” buttons. It can be done in two modes: short mode (date, time, code, fault description) or full mode - with additional information about electrical parameters and status of inputs and outputs. To switch between modes, press „SET” button.

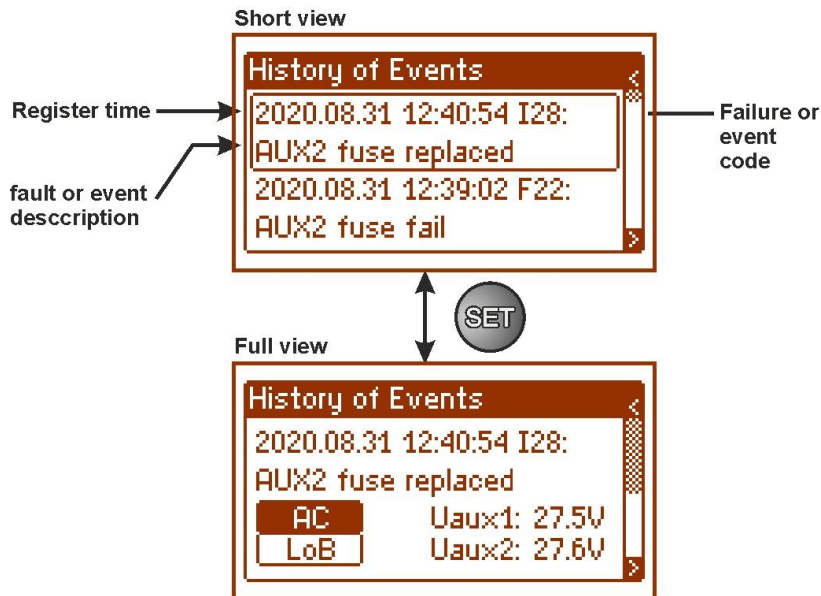

Fig. 21. Description of history of events screen.

Section 7.4.5 lists all codes that may occur during operation of PSU. Individual codes are accompanied by appropriate optical indication on panel, acoustic indication and activation of a dedicated technical output.



Memory of new power supply remembers events that are result of efficiency tests carried out at production stage.

7.4.5. List of failure codes and information messages.

PSU indicates operation status with appropriate code. Codes are divided into two groups, marked with initial letters „F” or „I”.

Codes beginning with letter „F” indicate a failure. Codes that begin with letter „I” indicate correct operation of PSU or repaired fault, involving, for example, fuse replacement: „I03 - BAT fuse replaced”.

Table 7. List of failure codes of power supply unit.

Failure code	Information	Technical output activation	Additional information	Additional information
F01	AC power fail!	EPS FLT ALARM	– No AC mains supply – Burnt main fuse F _{MAIN}	
F02	AUX1 fuse!	ALARM	– Blown FAUX1 fuse	
F04	Output overload!	ALARM	– PSU overload	see section 5.4
F05	Undercharged battery!	ALARM	– Worn out battery – Undercharged batteries	see section 6
F06	High AUX1 voltage!	ALARM	– Output voltage over 29.2 V	
F08	Charge circuit fail!	ALARM	– Output voltage of PSU set too low, below 26 V – Battery charging circuit failure	
F09	Low AUX1 voltage!	ALARM	– Output voltage below 26V	
F10	Low battery voltage!	ALARM	– Battery voltage has dropped below 23 V (during battery-assisted operation)	
F11	Low battery volt. – off!	ALARM	– Battery voltage has dropped below 20 V (during battery-assisted operation)	see section 6.4
F12	External input EXT!	ALARM	– Activation of input of collective failure EXT _i	see section 5.2
F14	Temp. sensor malfunction!	ALARM	– Temperature sensor damaged – Temperature sensor disconnected	see section 6.7
F15	High battery temperature!	ALARM	– The ambient temperature of the PSU is too hot – Batteries overloaded – Batteries damaged	see section 6.7
F16	No battery!	ALARM	– Batteries disconnected	see section 6.1
F17	Battery fail!	ALARM	– Batteries depleted, voltage below 20 V	see section 6.1
F18	High resistance of battery circuit!	ALARM	– Worn out battery – Battery connection cables loose	see section 6.6
F21	PSU cover opened!	ALARM	PSU cover opened	see section 5.3
F22	AUX2 fuse!	ALARM	– Blown FAUX2 fuse	
F26	High AUX2 voltage!	ALARM	– Output voltage over 29.2 V	
F29	Low AUX2!	ALARM	– Output voltage below 26 V	
F51 F52	internal damage of PSU	ALARM	– Service codes	
F60	No communication	ALARM	– No communication with LCD panel	
F61 F64	Control panel fail	ALARM	– Service codes	
F65	Access unlocked		– Passwords unlocked	
F69-F74	Default settings	ALARM	– Service codes	

Table 8. List of failure codes and information messages.

Message code	Description
I00	Power supply start-up
I01	AC power back
I02	AUX fuse replaced
I04	Battery connected
I05	Battery OK
I06	Battery temp. correct
I10	Battery test – START
I11	PSU cover closed
I28	AUX2 fuse replaced

Failure code of PSU can also be checked in an alternative way. ALARM LED located on PCB of PSU, flashes specified number of times to indicate failure code according to table below. If PSU has several failures at the same time, they are all indicated consecutively.

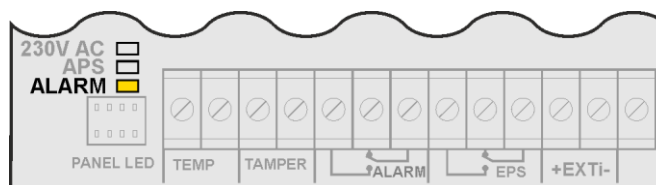

Fig. 22. LEDs ALARM.

Table 9. Coding of PSU failure by number of ALARM LED flashes on PCB of PSU.

Failure description	Number of flashes
F01 – No AC	1
F02 – AUX1 fuse is faulty	2
F04 – Output overload	3
F05 – Undercharged battery	4
F06 – High AUX1 voltage	5
F08 – Charging circuit failure	6
F09 – Low AUX1 voltage	7
F10 – Low battery voltage	8
F12 – External input EXT	9
F14 – Temp. sensor malfunction	10
F15 – High battery temperature	11
F16 – No battery	12
F17 – Battery fail	13
F18 – High resistance of battery circuit	14
F21 – PSU cover opened	15
F22 – AUX2 fuse is faulty	16
F26 – High AUX2 voltage	17
F29 – Low AUX2 voltage	18
F51 – Service code	19
F52 – Service code	20
F60 – Service code	21
F61, F64, F65, F69, F70, F71, F72, F73, F74 – Service code	22

8. LCD display – PSU settings.

PSU has a configuration menu, allowing to configure PSU settings by changing or activating certain parameters. To enter setting mode, press „SET” button from main screen’s level.

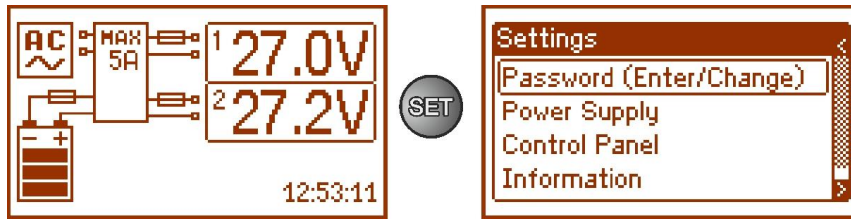

Fig. 23. PSU settings screen.

8.1. Password.

PSU supports two levels of access to configuration, which limit possibility of changing PSU’s settings from LCD panel. Both levels are protected by a separate password.

- Service password** – full access to PSU’s settings
- User’s password** – locked access to „PSU” settings menu

Table 10. Access ranges.

PASSWORD	Access range	
	„Control panel” settings	PSU settings
INSTALLER’S		
USER’S		No access



- Preset passwords:
- User’s password – 1111
 - Service password – 1234

8.1.1. Entering the password.

If the access to the PSU configuration has been blocked by an installer or user password, in order to unlock the PSU configuration:

– use „<” or „>” buttons to display menu **Password (enter/change)**



– press „SET” button, another window with available levels of passwords will be displayed



– use „<” or „>” buttons to choose right level of password



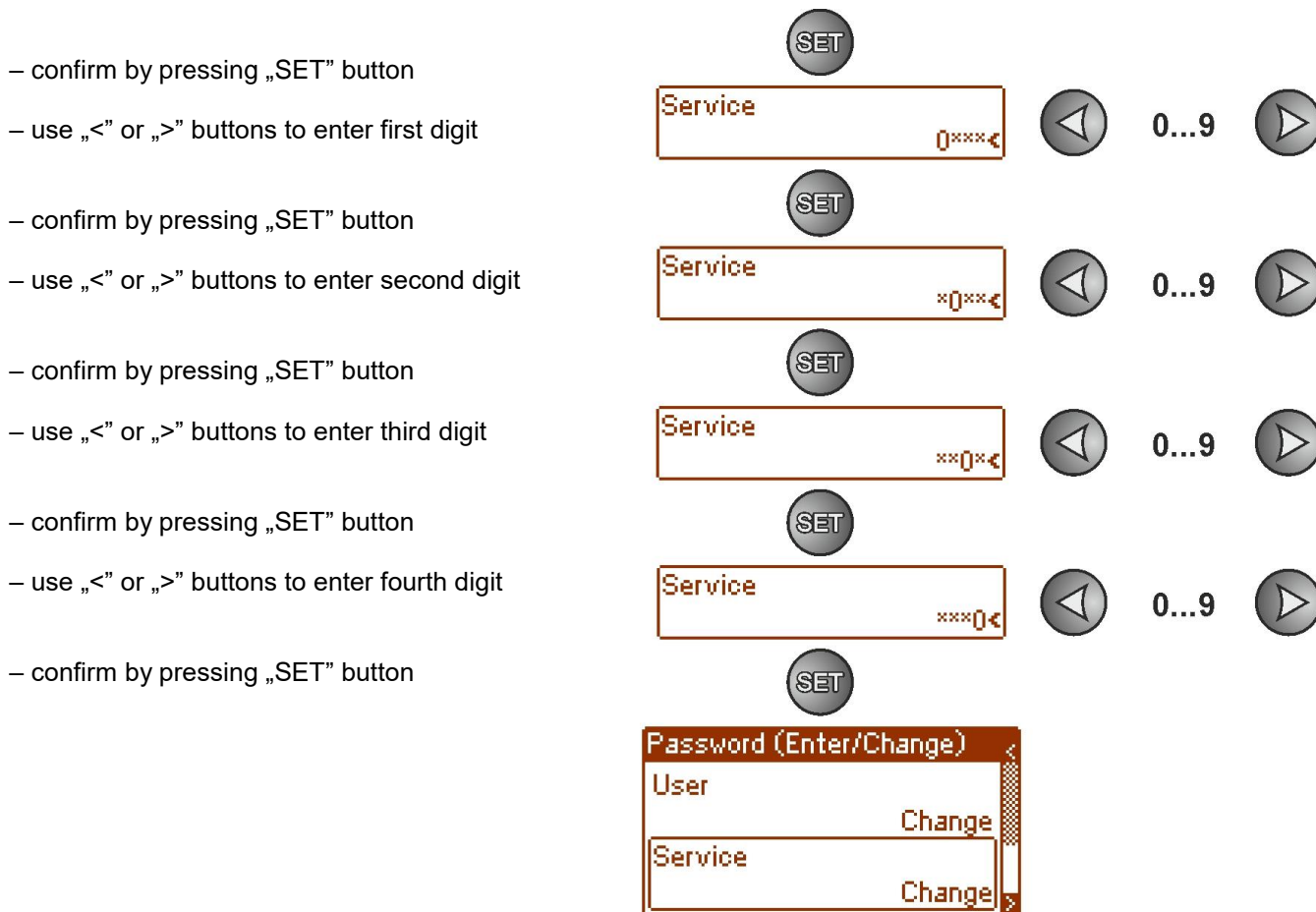

If entered password is wrong, following message will be displayed:



Fig. 23. Message after entering a wrong password.

After entering correct password, it is possible to access settings. If no buttons are pressed within 5 minutes, PSU settings will be locked automatically.

8.1.2. Changing password.

After entering correct password, it is possible to change it. To do this, choose a password that will be changed (user's password or service password) and enter new one.

8.1.3. Disabling the password

If password is not required, it can be turned off. Access to settings will not be locked after 5 minutes of inactivity. To disable password, type „0000” as a new password.

User password „0000” unlocks access from user level.

Service password „0000” unlocks access from installer level.

8.1.4. Resetting passwords.

If the passwords are lost for any reason, a procedure may be performed to enable the reassignment of the factory default passwords.

In order to perform this procedure, one should access the interior of the PSU casing. Locate the JP jumper in the rear part of the PCB of the LCD; it is used in the password unlocking procedure.

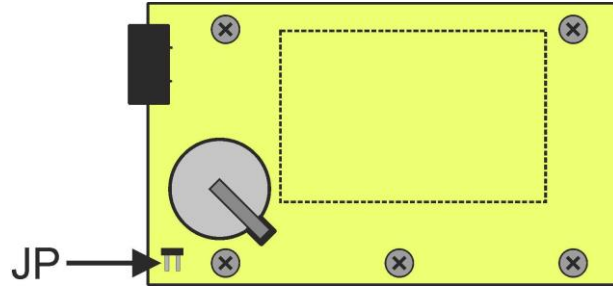

Fig. 25. Location of the JP jumper used in the password unlocking procedure.

Password unlocking procedure.

Switch off the PSU completely for a minimum of 10 s. Disconnect the PSU both from the 230 V network and from the batteries.

Place the JP jumper.

Connect the batteries and switch on the 230 V network supply.

Within 5 s from switching the PSU on, remove the JP jumper.

The message „Access unlocked” will appear on the display; confirm by pressing „SET”

Go to the menu „Settings -> Password” and replace the passwords with new ones.

8.1.5. Keyboard lock.

The PSU enables setting a key lock of the LCD panel.

The key lock function may only be selected if the installer password has been set. If the installer password is permanently unlocked with the „0000” code, the key lock option will not be available.

– use „<” or „>” buttons to display **Keyboard lock** menu



– press „SET” button, prompt will appear at end of line



– use „<” or „>” buttons to select
YES – keyboard lock ON
NO – keyboard lock OFF



– confirm by pressing „SET” button



When on, keyboard will be locked automatically if no buttons are pressed within 5 minutes. After this time, pressing any button on control panel will display a window with keyboard password request. Enter password using „<” or „>” buttons as explained above.



Fig. 26. Keyboard password request.

Entering correct user's password unlocks access to settings from user level, while entering correct service password unlocks access to settings from installer level – full access.



After entering correct password, it is possible to access settings. If no buttons are pressed within 5 minutes, PSU settings will be locked automatically.

8.2. PSU.



„PSU” menu is only available after entering the correct service password.

Selecting „PSU” in settings menu will display another menu, allowing full configuration of PSU: battery test performance, setting delay time for EPS output and setting communication parameters. After entering right settings, they are stored in internal non-volatile memory, which protects PSU against data loss in case of a failure or power failure.

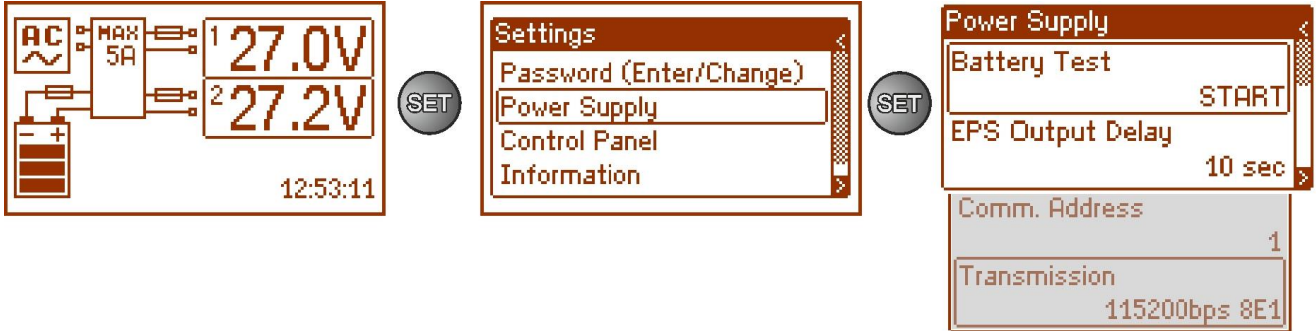

Fig. 27. „PSU” screen.

Table 11. Description of „PSU” screen.

Position	Description	Additional information
Battery test	START – battery test performance	Section 8.2.1 i 6.5
Delay time for EPS output	Setting delay time for 230 V AC power failure indication: – 10s (factory settings) – 1min – 10min – 30min	Section 8.2.2
Acoustic indication	1 ÷ 247 PSU address required during communication with computer 1 – factory settings	Section 8.2.3
Transmission	Defines speed and protocol of communication 9600 8N2 9600 8E1 (factory settings) : 115200 8E1	Section 8.2.4

8.2.1. Battery test performance.

The function enables testing of the batteries (see section 6.5) connected to the PSU. If the test result is negative, this will be signalled on the display by an appropriate message and change of the output status to ALARM.

- use „<” or „>” buttons to display **Battery test** menu
- press „SET” button, prompt will appear at end of line
- confirm by pressing „SET” button (the battery test takes place immediately upon confirmation)

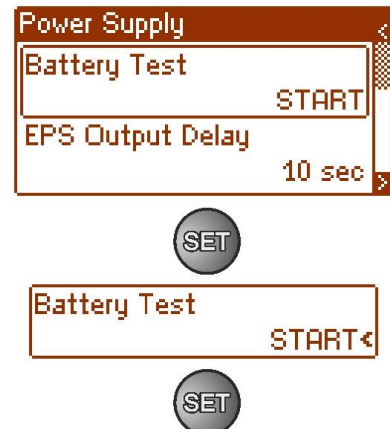

– during the test, the **WAIT** message appears on the screen

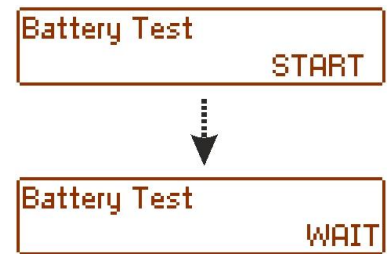

The PSU has a software protection against too frequent testing of batteries, which could cause them to undercharge. The protection consists in blocking the option of performance of the test for 60 s since it has last been enabled. In such situation, the „WAIT” message appears on the LCD in the Settings -> PSU -> Battery Test menu.

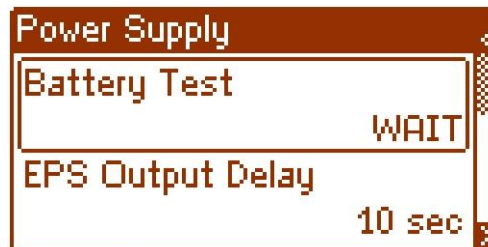

Fig. 28. Temporary battery test blockade.

Temporary blockade option may be disabled through placing JP jumper on PCB panel of display.

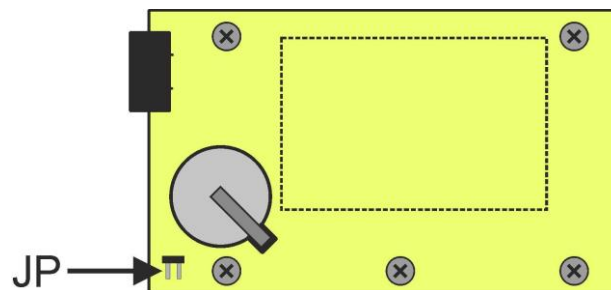

Fig. 29. Location of the JP jumper on the PCB panel of the display.

The battery test function will also be automatically blocked if the PSU is in a working mode in which running of the battery test would not be possible. Such a condition occurs e.g. during battery-mode operation. In such situation, the LCD shows the message „PROHIBITED” in the Settings -> PSU -> Battery Test menu.



Fig. 30. Battery test – „PROHIBITED”.

8.2.2. Setting delay time for EPS output indicating 230 V AC power loss.

PSU features adjustable delay for 230 V AC power loss indication. Delay time can be selected from four available ranges:

- 10s (factory settings)
- 1min
- 10min
- 30min

230 V power loss is indicated by activation of „EPS FLT” and „ALARM” technical output.

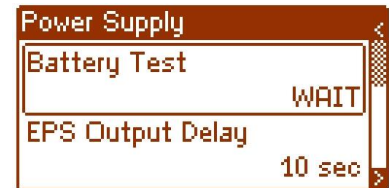

– use „<” or „>” buttons to display Delay **time for EPS output** menu

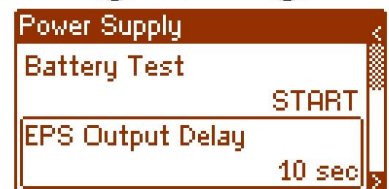

– press „SET” button, prompt will appear at end of line



– use „<” or „>” buttons to set delay time

- **10sec**
- **1min**
- **10min**
- **30min**



– confirm by pressing „SET” button



8.2.3. Setting communication address – refers to cooperation with the interface.



All power supplies are factory-set to address 1.

Communication address allows to identify power supply units in same communication network RS485.

– use „<” or „>” buttons to display **Communication address** menu

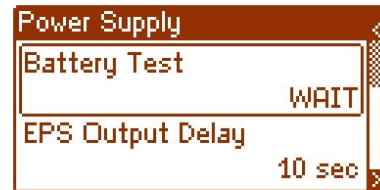

– press „SET” button, prompt will appear at end of line



– use „<” or „>” buttons to set communication address
1 ÷ 247 – PSU address during communication with computer



– confirm by pressing „SET” button



8.2.4. Setting transmission parameters – refers to cooperation with the interface.

– use „<” or „>” buttons to display **Transmission** menu

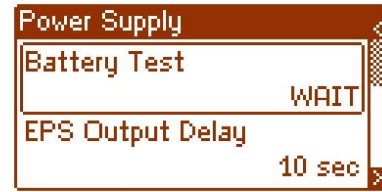

– press „SET” button, prompt will appear at end of line



– use „<” or „>” buttons to set transmission speed

- **9600bps 8N1** (factory setting)
- **115200bps 8E1**

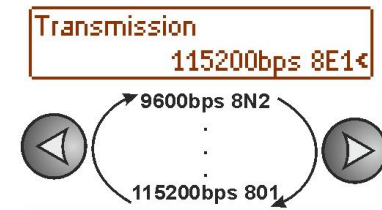

– confirm by pressing „SET” button



8.3. Control panel.



Menu is only available after entering correct user's or service password.

„Control panel” menu enables configuration of settings directly related to user interface. It is possible to set display language, date, time, intensity of backlight and blinking light indicating failure.

Setting correct date and time is important for keeping chronology of events stored in internal memory. Setting backlight mode and contrast guarantees quality of displayed messages.

Intensity of LCD backlight can be set in range from 0 to 100%, in 10% intervals.

Display features a function of constant or temporary backlight mode. In temporary mode, screen will turn off if no buttons are pressed within 5 minutes.

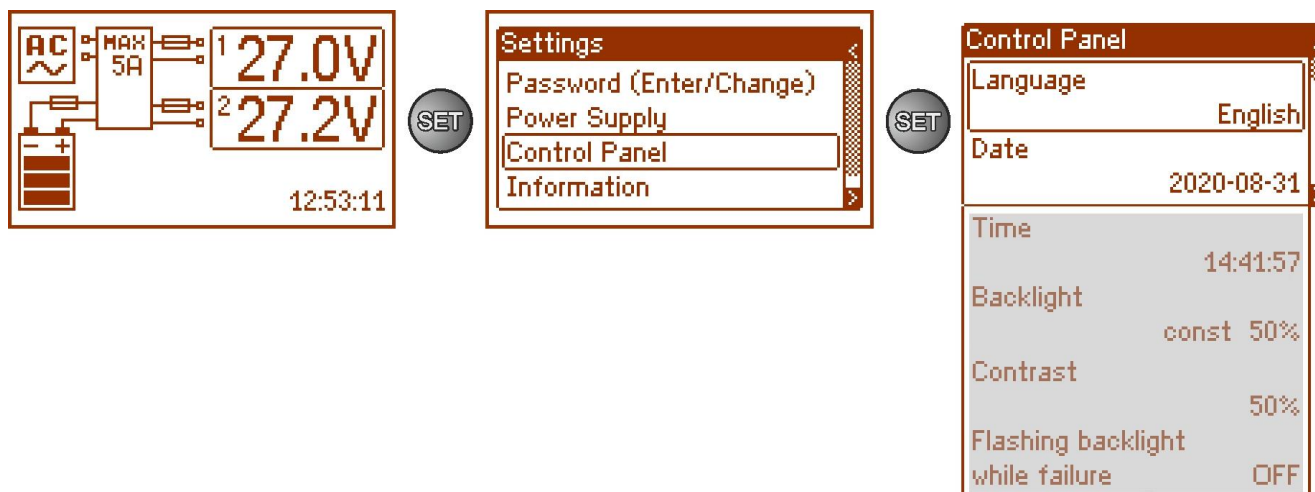

Fig. 31. Ekran „Pulpit”.

Table 12. Description of „Control panel” screen.

Position	Description
Language	Available languages
Date	Current date
Time	Current time
Highlighting	5 min – backlight mode OFF if no buttons are pressed within 5 min Constant – backlight will not be turned off 0÷100% – intensity of backlight
Contrast	0÷100% – display contrast
Blinking light indicating failure	YES – blinking light indicating failure NO – constant light indicating failure

8.3.1. Setting display language.

One of functions of control panel menu is possibility to select language. Display language can be set according to personal preference.

– use „<” or „>” buttons to display **Language** menu

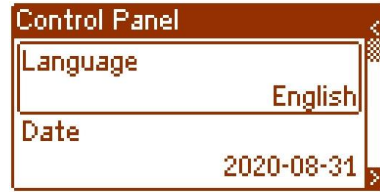

– press „SET” button, prompt will appear at end of line



– use „<” or „>” buttons to choose display language



– confirm by pressing „SET” button



To facilitate the user’s selection of the language of messages, the PSU enables calling up a menu on the main screen, displaying all available languages. To this end, press the arrow keys „<” and „>” on the front panel of the PSU simultaneously and hold them for a minimum of 5 seconds.

8.3.2. Setting date.

„Date” menu in „Control panel” menu enables setting correct date, according to which error messages and operation history will be saved. Built-in real time clock does not take into account leap years and changes resulting from switch between summer and winter time. These changes should be taken into account when analyzing events recorded in history.

– use „<” or „>” buttons to display **Date** menu

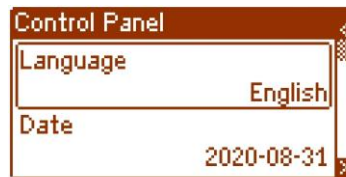

– press „SET” button, prompt will appear next to year digits



– use „<” or „>” buttons to set year

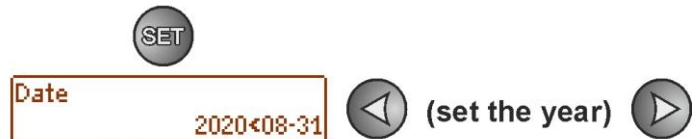

– press „SET” button, prompt will appear next to month position



– use „<” or „>” buttons to set current month



– press „SET” button, prompt will appear next to day position

– use „<” or „>” buttons to set current day



– confirm by pressing „SET” button



8.3.3. Setting time.

„Time” menu in „Control panel” menu enables setting correct time, according to which error messages and operation history will be saved. Built-in real time clock does not take into account leap year and changes resulting from switch between summer and winter time. These changes should be taken into account when analyzing events recorded in history.

– use „<” or „>” buttons to display **Time** menu

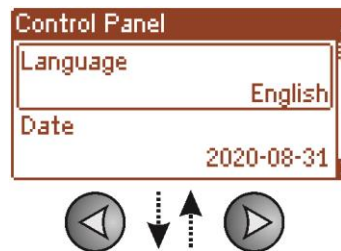

– press „SET” button, prompt will appear next to hour digits

– use „<” or „>” buttons to set hour



– press „SET” button, prompt will appear next to minute position

– use „<” or „>” buttons to set minutes



– press „SET” button, prompt will appear next to seconds' position

– use „<” or „>” buttons to set seconds



– confirm by pressing „SET” button



8.3.4. Setting backlight mode.

„Backlight” menu dims display if no buttons are pressed within 5 min and sets intensity of backlight.

– use „<” or „>” buttons to display **Backlight mode** menu



– press „SET” button, prompt will appear next to **constant**< option



– use „<” or „>” buttons to change setting to **5 min**

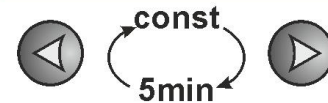

– press „SET” button, prompt will appear at end of line



– use „<” or „>” buttons to set required brightness



– confirm by pressing „SET” button



8.3.5. Contrast setting.

„Contrast” menu in „Control panel” enables setting contrast of display text.

– use „<” or „>” buttons to display **Contrast** menu



– press „SET” button, prompt will appear at end of line



– use „<” or „>” buttons to set contrast

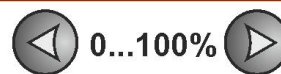

– confirm by pressing „SET” button



8.3.6. Blinking light indicating failure

"Blinking light indicating failure" menu enables setting backlight mode during failure indication. When on, blinking light will indicate a failure.

– use „<” or „>” buttons to display Blinking **light indicating failure** menu

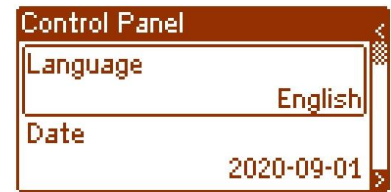

– press „SET” button, prompt will appear at end of line



– use „<” or „>” buttons to select
YES – blinking light indicating failure ON
NO – blinking light indicating failure OFF

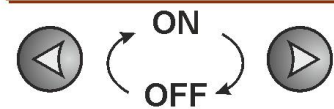

– confirm by pressing „SET” button



9. Remote monitoring (options)

PSU has been adjusted to operate in a system that requires a remote control of parameters in a monitoring centre. Implementation of this function is possible upon installation of an additional communication interface. Data are transmitted using the modbus protocol, and their exchange may be effected through a RS485 bus or through the Ethernet.



When installing optional features in power supply unit, power supply current consumption, used for calculation of standby time, should be taken into account (see section. 6.8).

9.1. ETHERNET network communication.

Communication in Ethernet network is possible due to additional Interface: Ethernet „INTE-C”, compliant to IEEE802.3 standard. Ethernet „INTE-C” interface features full galvanic isolation and protection against surges. It should be mounted inside enclosure of PSU. Upon installation, a possibility of connection to the Ethernet is enabled.

An example diagram of PSUs connected to the Ethernet via the INTE-C interface is presented below.

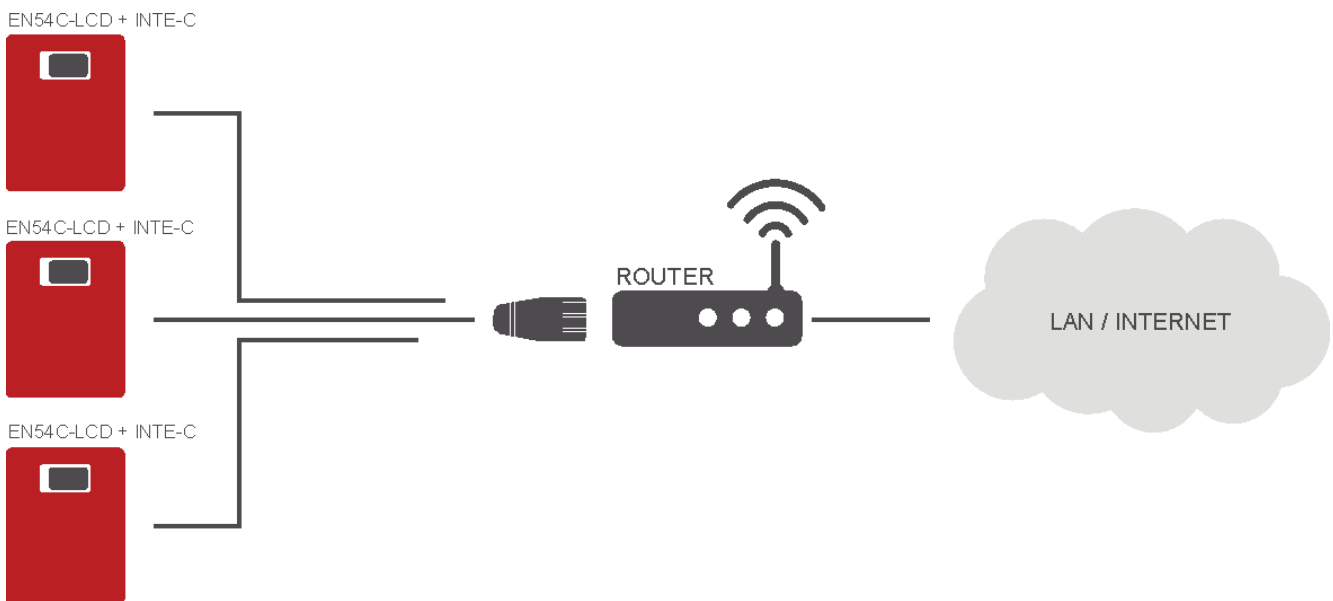

Fig. 32. Ethernet network communication using Ethernet „INTE-C” interface.

9.2. RS485-ETHERNET network communication.

Communication with the PSUs may be effected on the basis of the RS485 bus via additional „INTR-C” and „INTRE-C” modules..

In this kind of communication, an additional RS485-TTL „INTR-C” interface must be installed in each PSU, enabling connection of the PSU to the RS485 bus. A maximum of 247 PSUs may be connected to the bus. Connection with the Ethernet will be enabled by the RS485-ETHERNET „INTE-C” interface equipped with a RJ45 socket.

RS485-ETHERNET „INTRE-C” interface is a device used to convert signals between RS485 bus and Wi-Fi network. For proper operation, unit requires an external power supply in range of 10÷30 V DC e.g. drawn from a PSU of EN54C-LCD series. Unit is mounted in a hermetic enclosure protecting against adverse environmental conditions.

An example diagram of PSUs working in a RS485 bus, connected to the Ethernet, has been presented below.

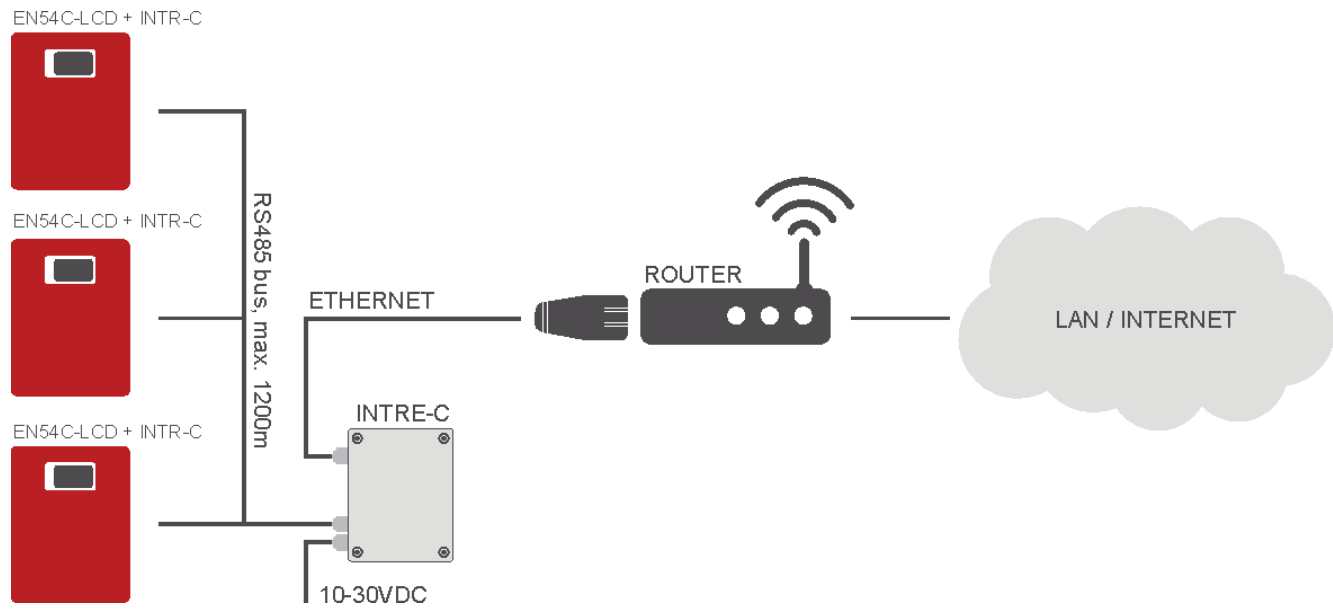

Fig. 33. Ethernet network communication using „INTR-C” and „INTRE-C” interfaces

9.3. „PowerSecurity” web application

The PowerSecurity web application has been embedded in the INTE-C and INTRE-C communication interfaces. The programme is a website uploaded from an embedded WWW server which is loaded upon entering the IP address in the web browser window.

Upon loading the PowerSecurity application, access is gained to the preview of the status of the PSU connected with the INTE-C interface (see Section 9.1), or the preview of all PSUs in the RS485 bus in case of an INTRE-C interface (see Section 9.2).

From the level of the WWW browser, the current status of the PSU may be checked, enabling access to such parameters as output voltages, presence of 230 V supply, or resistance of the battery circuit. Moreover, the application includes an option of interface configuration for the function of remote alerting via email notifications in which information on the PSU status is sent in case of occurrence of specific events.

The drawing below shows the appearance of a tab with the current PSU status.

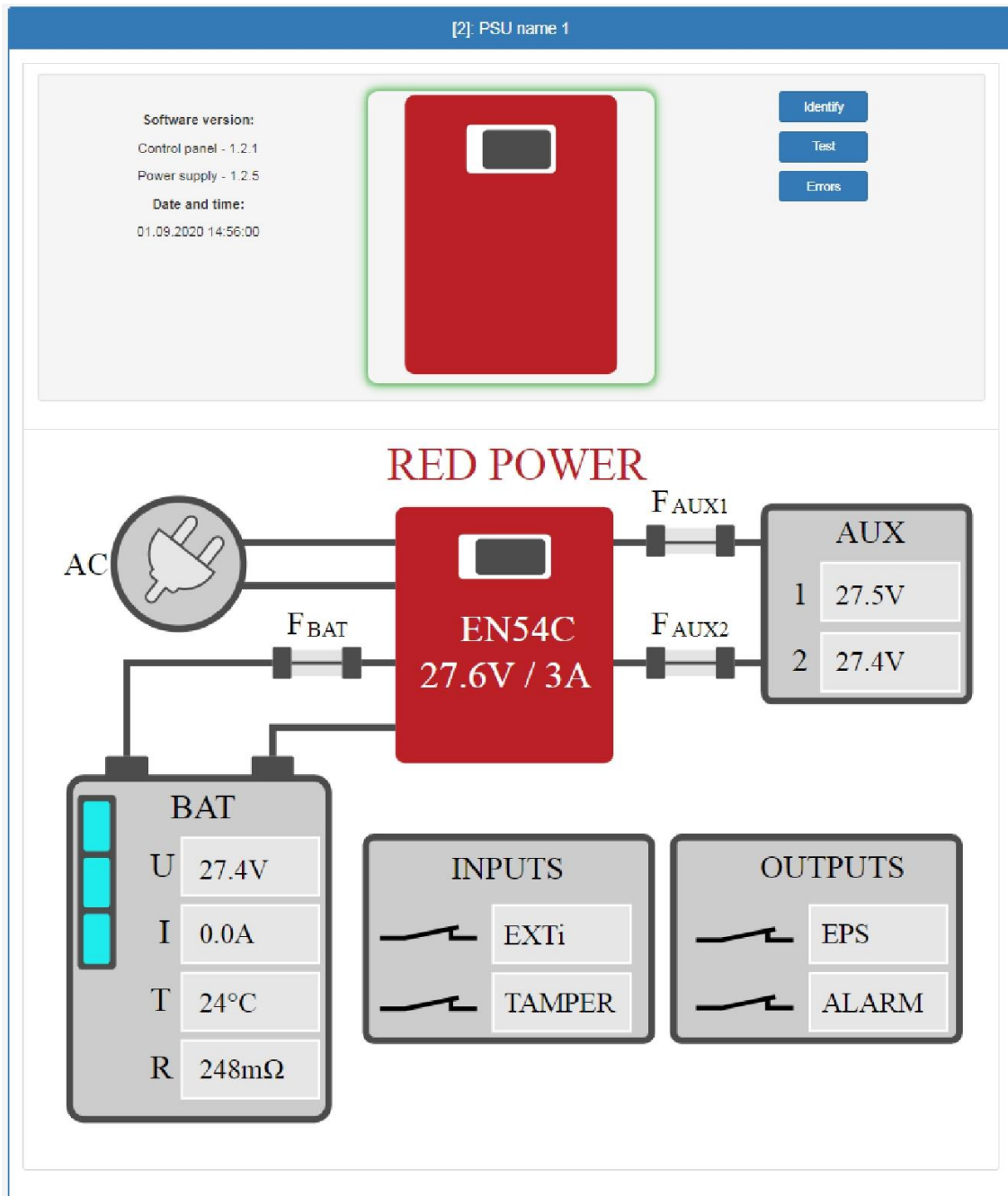

Fig. 34. View of the PSU status.

The web application also has a graphic tab „Graphs” from which the PSU history of operation may be downloaded and viewed in the graphic form, as a graph. A read graph may be saved in a file on a disc.

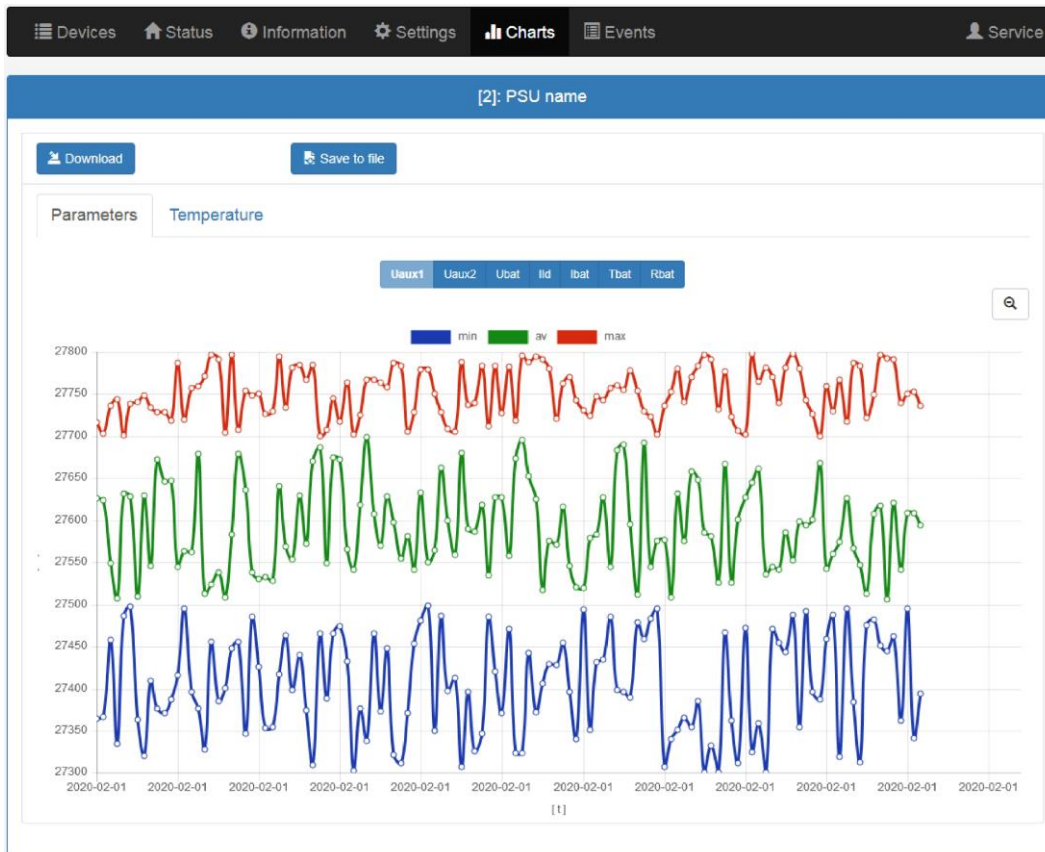

Fig. 35. View of the history of operation of PSU.

Another tab enabling checking of the PSU history is the tab of events. The read history is displayed as a table, following a chronological order. From the table, we can read the exact time of occurrence of the event, the error code, the event type description, as well as electric parameters and the status of individual technical outputs.

	Date and time	Event description	Signals	U [V]	I [A]	T [°C]	R [mΩ]
1	02.09.2020 07:04:12	F16 - No battery	Ac: On LoB: Off ExtI: Off Aps: On Eps: Off Alarm: On	Aux1: 27.4V Aux2: 27.1V Bat: 0.0V	Ld: 0.0A Bat: 0.0A	24°C	---
2	02.09.2020 06:57:50	I00 - Power supply start-up	Ac: On LoB: Off ExtI: Off Aps: Off Eps: Off Alarm: Off	Aux1: 27.6V Aux2: 27.4V Bat: 9.1V	Ld: 0.0A Bat: 0.0A	24°C	---
3	01.09.2020 15:00:57	F10 - Low battery voltage	Ac: Off LoB: On ExtI: Off Aps: On Eps: Off Alarm: On	Aux1: 18.2V Aux2: 18.0V Bat: 18.0V	Ld: 0.0A Bat: 0.0A	25°C	---

Fig. 36. View of the history of events.

The PowerSecurity programme provides functionality in the form of a remote battery test and the function of remote alerting via automatically sent email notifications. The notifications contain information on the current error codes, with the exact malfunction occurrence time.

The email notifications are sent to 2 recipients. The service includes SSL encryption of the mail and authorization for the user's verification through the outgoing mail system (SMTP) in order to ensure safety of the mail account.

The intervals of alerting and kinds of events triggering the sending of a notification are configurated individually by the user.

The screenshot shows a web interface for configuring email notifications. At the top, a dark navigation bar contains icons and labels for 'Devices', 'Status', 'Information', 'Settings' (which is active), 'Detection', 'Update', and 'Service'. Below this, a blue header bar displays the IP address '[192.168.84.81]: ETH name'. The main configuration area is divided into several sections:

- E-MAIL**: This section contains various settings:
 - Activate**: A checkbox that is currently unchecked.
 - IP address**: A text input field containing '192.168.3.200'.
 - Port**: A text input field containing '25'.
 - Authorisation**: A checkbox that is currently unchecked.
 - User name**: A text input field containing 'sender'.
 - Password**: An empty text input field.
 - Sender**: A text input field containing 'sender@domain.pl'.
 - Receiver 1**: A text input field containing 'receiver1@domain.pl'.
 - Receiver 2**: A text input field containing 'receiver2@domain.pl'.
 - Language**: A dropdown menu currently set to 'English'.
 - Test e-mail**: A blue button labeled 'Send'.
- Faults**: This section is used to select which events trigger email notifications:
 - Delay unit**: A dropdown menu currently set to 'Hours'.
 - Message delay time**: A text input field containing '1'.
 - ETH RS485/TTL**: A list of three events, each with a checked checkbox:
 - F51 - Internal device fail
 - F60 - No communication
 - F67 - Internal device fail
 - Power supply**: A list of two events, each with a checked checkbox:
 - F01 - AC power fail
 - F02 - AUX1 fuse fail

Fig. 37. View of the page of configuration of automatically sent email notifications.

10. Technical parameters.

Electrical parameters (Table 13).

Mechanical parameters (Table 14).

Safety of use (Table 15).

Operation parameters (Table 16).

Recommended types and sections of installation cables (Table 17).

Table 13. Electrical parameters.

	EN54C-2A17LCD	EN54C-2A17LCD	EN54C-3A17LCD	EN54C-3A17LCD	EN54C-3A28LCD	EN54C-5A17LCD	EN54C-5A17LCD	EN54C-5A28LCD	EN54C-5A40LCD	EN54C-5A65LCD	EN54C-10A17LCD	EN54C-10A28LCD	EN54C-10A40LCD	EN54C-10A65LCD
Functional class EN 12101-10:2005+AC:2007	A													
Mains supply	~230 V													
Current consumption	0,58 A		0,9 A		1,38 A				1,62 A					
Inrush current	40 A		40 A		50 A				60 A					
Power frequency	50 Hz													
Output power PSU	56,8 W		85,2 W		142 W				284 W					
Efficiency	88%		89%		87%				88%					
Output voltage at 20°C	22 V – 27,6 V DC – buffer operation 20 V – 27,6 V DC – battery-assisted operation													
Continuous output current I _{max a}	1,6 A	1,2 A	2,6 A	2,2 A	1,8 A	4,6 A	4,2 A	3,8 A	3,2 A	2,4 A	9,2 A	8,8 A	8,2 A	7,4 A
Instantaneous output current I _{max b} (5 min)	2 A		3 A		5 A				10 A					
Recommended battery capacity	7 Ah	17 Ah	7 Ah	17 Ah	28 Ah	7 Ah	17 Ah	28 Ah	40 Ah	65 Ah	17 Ah	28 Ah	40 Ah	65 Ah
Minimum battery capacity	7 Ah									17 Ah				
The maximum battery capacity	7,2 Ah	20 Ah	7,2 Ah	20 Ah	28 Ah	7,2 Ah	20 Ah	28 Ah	45 Ah	65 Ah	20 Ah	28 Ah	45 Ah	65 Ah
Battery charging current	0,4 A	0,8 A	0,4 A	0,8 A	1,2 A	0,4 A	0,8 A	1,2 A	1,8 A	2,6 A	0,8 A	1,2 A	1,8 A	2,6 A
Net/gross weight [kg]	3,7/3,9	5,0/5,3	3,7/3,9	5,0/5,3	7,1/7,8	3,8/4,0	5,1/5,5	7,2/7,9	7,6/8,2	12,4/13,3	5,6/6,0	7,7/8,4	8,1/8,7	12,9/13,7
Maximal resistance of the battery circuit	300 mΩ													
Ripple voltage (max.)	50 mVp-p		50 mVp-p		150 mVp-p				30 mVp-p					
Current consumption by the PSU during battery-assisted operation	64 mA		64 mA		67 mA				97 mA					
Coefficient of temperature compensation of the battery voltage	-36 mV/ °C (-5°C÷40°C)													

The LoB low battery voltage indication	U _{bat} < 23 V, during battery mode			
Overvoltage protection OVP	U > 32 V ± 2V, automatic recovery			
Short-circuit protection SCP	F4 A	F5 A	F6,3 A	F10 A
	– F _{AUX1} , F _{AUX2} melting fuse (failure requires fuse replacement)			
Overload protection OLP	105-150% of power supply, automatic recovery			
Battery circuit protection SCP and reverse polarity connection	F5 A	F6,3 A	F10 A	F12,5 A
	– FBAT melting fuse (failure requires fuse replacement)			
Deep discharge battery protection UVP	U < 20 V (± 2%) – disconnection of the batteries			
Tamper indicating enclosure opening	Microswitch TAMPER			
Technical outputs:				
– EPS FLT; indicating AC power failure	– relay type: 1 A @ 30 V DC / 50 V AC			
– ALARM; indicating collective failure	– delay 10s/1m/10m/30m (+/-5%) – configured from the LCD panel (factory settings 10s)			
	– relay type: 1 A @ 30 V DC / 50 V AC			
Technical inputs:				
– EXTi; external failure input	Closed input – no indication Open input - alarm			
– TAMPER; input of the microswitch tamper	Closed input – no indication Open input - alarm			
Optical indication:	<ul style="list-style-type: none"> – LEDs on PCB of power supply unit (see section 3.3) – LCD panel <ul style="list-style-type: none"> display of electrical parameters, e.g. voltage, current, resistance of circuit readings failure indication PSU settings adjusted from panel's level operation memory of PSU – 100 days failure history – 2048 events real-time clock, battery-backed 			
LCD battery	3 V, lithium, CR2032			
Fuses:				
– F _{BAT}	F 5 A/250 V	F 6,3 A/250 V	F 10 A/250 V	F 12,5 A/250 V
– F _{AUX1}	F 4 A/250 V	F 5 A/250 V	F 6,3 A/250 V	F 10 A/250 V
– F _{AUX2}	F 4 A/25 0V	F 5 A/250 V	F 6,3 A/250 V	F 10 A/250 V
Additional equipment (not included)	<ul style="list-style-type: none"> – Interface RS485-TTL „INTR-C”; RS485 communication – Interface RS485-Ethernet „INTRE-C”; RS485-Ethernet communication – Interface INTE-C; Ethernet communication – Fuse modules: EN54C-LB4, EN54C-LB8 – Sequential modules: EN54C-LS4, EN54C-LS8 			

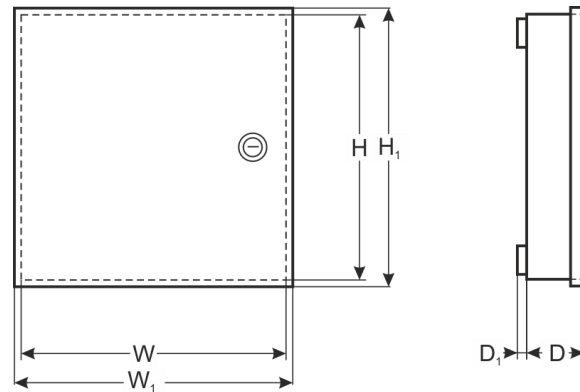
**Table 14. Mechanical parameters.**

Battery space:	2x7Ah	2x17Ah	2x28Ah	2x40Ah	2x65Ah
Enclosure dimensions	W=330, H=305, D+D ₁ =82+8 W ₁ =335, H ₁ =308 [+/- 2mm]	W=385, H=402, D+D ₁ =88+8 W ₁ =390, H ₁ =406 [+/- 2mm]	W=420, H=407, D+D ₁ =178+8 W ₁ =425, H ₁ =411 [+/- 2mm]		W=410, H=648, D+D ₁ =180+8 W ₁ =416, H ₁ =652 [+/- 2mm]
Mounting (WxH)	303x230 xΦ6 x4 pcs [mm]	358x325 xΦ6 x4 pcs [mm]	388x380 xΦ6 x4 pcs [mm]		378 x 570 xΦ6 x4szt [mm]
Fitting battery (WxHxD) (max.)	2x7Ah/12V (SLA) 315x100x75 [+/- 2 mm] max	2x17Ah/12V (SLA) 375x180x80 [+/- 2 mm] max	2x28Ah/12V (SLA) 405x175x170 [+/- 2 mm]	2x40Ah/12V (SLA) 405x175x170 [+/- 2 mm]	2x65Ah/12V (SLA) 360x190x170 (x2) [+/- 2 mm]
Enclosure	Steel plate DC01 1mm		Steel plate DC01 1,2mm		Steel plate DC01 1,5mm
Closing	color: RAL 3001 (red) Key lock				
Terminals	Battery outputs BAT: 6,3F-0,75	Battery outputs BAT: Φ6 (M6-0-2,5)			
	Mains supply: Φ0,41±2,59 (AWG 26-10), 0,5±4mm ² Outputs: Φ0,51±2,05 (AWG 24-12), 0,5±2,5mm ²				
Cable glands	PG9 – cable diameter Φ4±8mm PG11 – cable diameter Φ5±10mm				
Notes	The enclosure does not adjoin the mounting surface so that cables can be led. Convection cooling.				

Table 15. Safety of use.

Protection class EN 62368-1	I (first)
Protection grade EN 60529	IP30
Insulation electrical strength: – between input (network) circuit and the output circuits of the PSU – between input circuit and protection circuit – between output circuit and protection circuit	4000 V DC 2500 V DC 500 V DC
Insulation resistance: – between input circuit and output or protection circuit	100 MΩ, 500 V DC

Table 16. Operation parameters.

Environmental class EN 12101-10:2005+AC:2007	1
Operating temperature	-5°C...+40°C
Storing temperature	-25°C...+60°C
Relative humidity	20%...90%, no condensation
Sinusoidal vibrations during operation: 10÷50 Hz 50÷150 Hz	0,1 G 0,5 G
Surges during operation	0,5 J
Direct insolation	unacceptable
Vibrations and surges during transport	According to PN-83/T-42106 standard

Table 17. Recommended types and sections of installation cables.

Mains supply ~230 V L-N-PE (Table1 [1])	HDGs 3 x 0,75 mm ² ...1,5 mm ² OMY 3 x 0,75 mm ² ...1,5 mm ²
AUX1, AUX2 output terminals (Table 1 [2])	HLGs 2 x 1,5 mm ² ...2,5 mm ²
Indication inputs/outputs (Table 1 [2])	YnTKSY 1 x 2 x 0,8 mm ²
Linie sygnałowe dodatkowe (opcja z interfejsem Ethernet)	FTP 4x2x0,5 kat.5e

11. Technical inspections and maintenance.

Technical inspections and maintenance can be performed after disconnecting the power supply from the power network. The PSU does not require any specific maintenance, however, its interior should be cleaned with compressed air if it is used in dusty conditions. In case of fuse replacement, use only compatible replacement parts.

Technical inspections should be carried out not less frequently than once per year. During the inspection, check the batteries and run the battery test.

4 weeks after installation, re-tighten all threaded connections, (see Fig 2 [1,2]).

11.1. Battery replacement of LCD panel.

Estimated operating time of battery type CR2032 is about six years. After this period, battery will need to be replaced.

Battery replacement of LCD panel should be done during mains operation or battery-assisted operation in order to avoid resetting time settings.



Caution!

Removed batteries should be stored in a designated collection point. Do not reverse polarity of batteries. Explosion hazard if a battery has been replaced by an incorrect type.



WEEE MARK

According to the EU WEE Directive – It is required not to dispose of electric or electronic waste as unsorted municipal waste and to collect such WEEE separately.



CAUTION! The power supply unit is adapted for cooperation with the sealed lead-acid batteries (SLA). After the operation period they must not be thrown but recycled according to the applicable law.

Pulsar sp. j.

Siedlec 150, 32-744 Łapczyca, Poland

Tel. (+48) 14-610-19-45

e-mail: sales@pulsar.pl

http:// www.pulsar.pl

