

# HDCVI Camera

## User's Manual

V1.0.2

1.2.51.32.11346-000

### Welcome

Thank you for purchasing our HDCVI camera!  
This user's manual is designed to be a reference tool for your system. Please read the following safeguard and warnings carefully before you use this series product!  
Please keep this user's manual well for future reference!

### Important Safeguards and Warnings

#### 1. Electrical safety

- All installation and operation here should conform to your local electrical safety codes.
- The power shall conform to the requirement in the SELV (Safety Extra Low Voltage) and the Limited power source is rated DC 12V or AC24V in the IEC60950-1. (Power supply requirement is subject to the device label).
- Please install easy-to-use device for power off before installing wiring, which is for emergent power off when necessary.
- Please check if the power supply meets the requirements of working voltage of the camera before operating the device (The material and length of the power supply cable will influence terminal voltage value).
- Please prevent the line cord from being trampled or pressed, especially the plug, power socket and the junction from the device.

#### 2. Environment

- Please don't aim the device at strong light (such as lighting, sunlight and so on) to focus.
- Please transport, use and store the device within the range of allowed humidity and temperature.
- Please do not allow water and other liquid falling into the camera in case that the internal components are damaged.
- Please keep the sound ventilation in case of heat accumulation.
- Heavy stress, violent vibration or water splash are not allowed during transportation, storage and installation.
- Please pack the device with standard factory packaging or material with same quality when transporting the device.
- It is recommended to use the device together with lightning protection device to enhance lightning protection effect.
- It is recommended to GND the device to enhance device reliability.
- It is advised to use qualified video transmission cable to improve video quality. It is recommended to use 75-3 coaxial cable or higher standard.

#### 3. Warning

- Please use the standard accessories provided by manufacturer and make sure the device is installed and fixed by professional engineers.
- Please prevent the device surface from the radiation of laser beam when using laser beam device.
- Please do not provide two or more power supply modes for the device, otherwise it may cause damage to the device.

#### 4. Statement

- Please refer to the actual product for more details; the manual is just for reference.
- The manual will be regularly upgraded according to the product update; the upgraded content will be added in the manual without prior announcement.
- Please contact the customer service for the latest procedure and supplementary documentation.
- The company is not liable for any loss caused by the operation which is not followed by the manual.
- Please refer to the company's final explanation if there is any doubt or dispute.

## 1 General Introduction

### 1.1 Overview

This series HDCVI camera conforms to the HDCVI standard. It supports video signal high-speed long distance transmission without any delay. It can be controlled by the HCVR conforming to the HDCVI.

### 1.2 Features

- Adopt high performance CMOS image sensor, megapixel definition.
- Support coaxial transmission of HD video, audio and control signal.
- For 720P series, it supports RG59 coaxial transmission without any loss, the distance is over 800m, for 1080P series, it supports RG59 coaxial transmission without any loss, the distance is over 500m.
- High speed, long distance real-time transmission.
- Support HD/SD video output. (some devices only support HD video output)
- Support OSD menu adjusting parameters.
- Support auto exposure, AWB, auto electronic gain.
- Support true WDR function, the range can reach 120dB (only supported by WDR models)
- Support DC 12V power supply.
- Pinhole cameras can be applied to covert places such as ATM; mobile cameras can be applied to places such as bus, school bus and subway etc.

## 2 Device Structure

### 2.1 Dimension

Refer to Figure 2-1, Figure 2-2 and Figure 2-3 for the dimension of model A. The unit is mm.

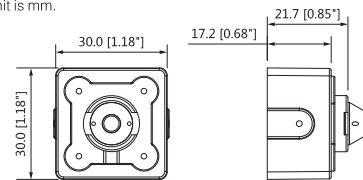

Figure 2-1

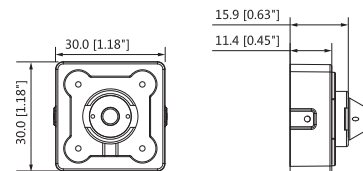

Figure 2-2

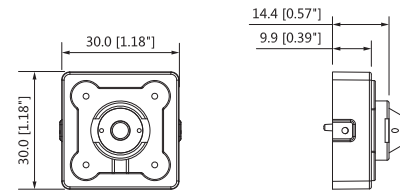

Figure 2-3

Refer to Figure 2-4 for the dimension of model B. The unit is mm.

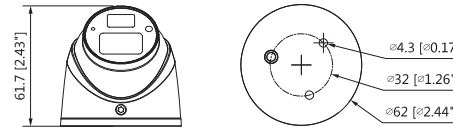

Figure 2-4

Refer to Figure 2-4 for the dimension of model B. The unit is mm.

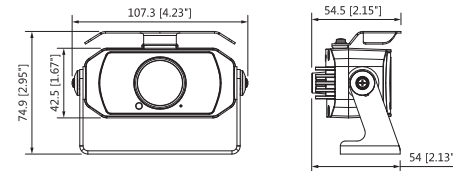

Figure 2-5

Refer to Figure 2-6 for the dimension of model D1. The unit is mm.

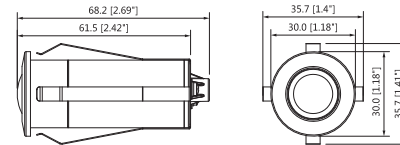

Figure 2-6

Refer to Figure 2-7 and Figure 2-8 for the dimension of model D2 and model D3. The unit is mm.

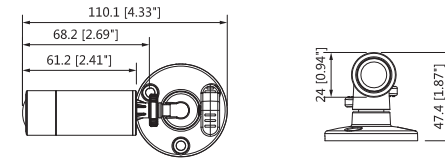

Figure 2-7

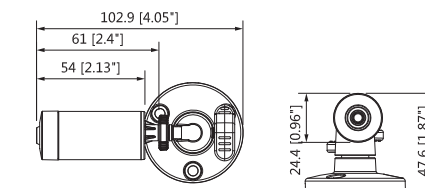

Figure 2-8

### 2.2 Cable Port

#### Note

- The following figures are for reference only, which are only used to know the function of cable port.
  - Different devices may have different cables, please refer to the actual device for more details.
- Please refer to Figure 2-9 for DC 12V power input port.

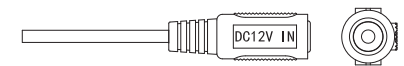

Figure 2-9

Please refer to Figure 2-10 for video output port.

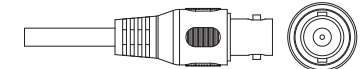

Figure 2-10

Please refer to Figure 2-11 for audio input port.

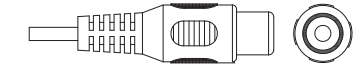

Figure 2-11

Please refer to Figure 2-12 for HD/SD switch control cable.



Figure 2-12

#### Note

- When the two cables become short circuit, then it can realize from HD video output to SD video output. On the contrary, it will switch back to HD video output when the two cables become open circuit.
- HD/SD switch control cable is only supported by some models.

Please refer to Figure 2-13 for the mobile aviation port.

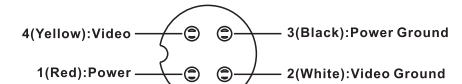

Figure 2-13

## 3 Installation

#### Attention:

- Please install the device in time after it is taken apart, which is to avoid the camera module being exposed to damp environment for too long.
- Before the installation, please make sure the installation surface is thick enough to sustain at least 3X weight of the camera.
- For the installation mode of side outlet, make sure the direction of side outlet is in accordance with that of the installation position map when sticking the installation position map. Besides, pull the cable through the pedestal cable slot before locking the screw.
- Please do not remove the electrostatic adsorption film (if yes) on the surface of transparent cover before installation and debugging is completed, which is to avoid damage during installation.
- The installation figures below are for reference only.

### 3.1 Installation for Model A

Model A mainly adopts ceiling installation mode, the installation location includes ceiling, wall or ATM.

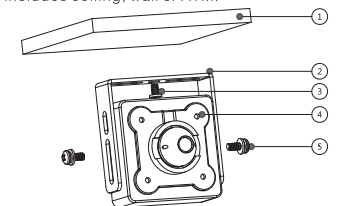

Figure 3-1

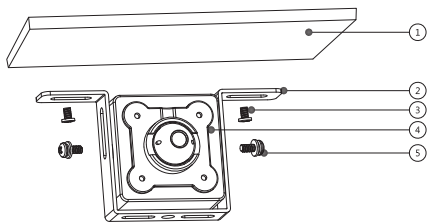

Figure 3-2

**Step 1**

Install the camera ④ together with the bracket ② on the fixed surface ① and secure the installation screw ③ firmly.

**Step 2**

Adjust the camera ④ angle and tighten the locking screw ⑤ on the enclosure firmly .

**Step 3**

Connect the video output port of device cable to the rear-end HCVR device and connect the power port to power. So far, the device installation and cable connection have been completed, you can check monitoring image via rear-end coding device.

**3.2 Installation for Model B**

Model B mainly adopts ceiling installation mode, the installation location includes ceiling and wall, or it can be installed on the internal ceiling of a vehicle.

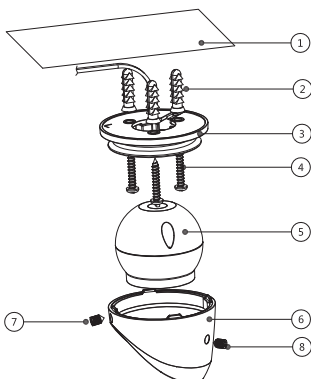

Figure 3-3

**Step 1**

Take down the pedestal ③.

Unscrew the locking screws ⑦ and ⑧ anticlockwise to make it separate.

**Step 2**

Take out the installation position map from the device accessories bag, paste it on the installation surface ①, and then dig holes on the installation surface according to the installation position map.

**Step 3**

Use tools to fix the expansion bolts ② into the installation holes.

**Step 4**

Adjust pedestal location (if it is side cable outlet, you can pull out the cable through the side cable slot). Align the bolt fixing holes of the device pedestal with the expansion bolt fixing holes on the installation surface; insert the self-tapping screws ④ into the expansion bolts and secure them firmly to make pedestal fixed on the installation surface (if it is top cable outlet, you can pull out the cable through the cable outlet on the installation surface after fixing the pedestal).

**Step 5**

Install dome body ⑤ and enclosure ⑥. Put the enclosure into the pedestal together with the dome body, insert locking screws clockwise and fix them preliminarily; rotate enclosure and dome body to an appropriate monitoring location; finally tighten the locking screws firmly.

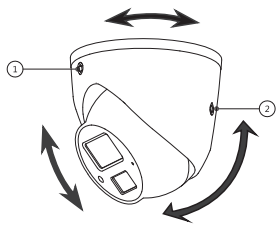

Figure 3-4

**Note**

Adjust the locking screws ① and ② shown in the figure above.

**Step 6**

Connect the device cable to the back-end HCVR device. So far, the device installation and cable connection have been completed, you can check monitoring image via rear-end coding device.

**3.3 Installation for Model C**

Model C can be installed on the vehicle operation platform, vehicle tail or it can be hung on the ceiling inside the vehicle.

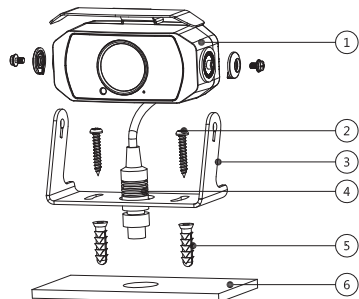

Figure 3-5

**Step 1**

Take down the bracket ③.

Unscrew the locking screws anticlockwise to make it separate.

**Step 2**

Use tools to fix the expansion bolts ⑤ on the installation board ⑥ according to the fixing holes of bolt.

**Step 3**

Adjust bracket location.

Align the bolt fixing holes of the device bracket with the expansion bolt fixing holes on the installation board; insert the installation screws ② into the expansion bolts and secure them firmly to make bracket fixed on the installation board.

**Step 4**

Install device body ①.

Adjust device body to a proper location and fix it on the bracket, finally tighten the fixing screw on the bracket firmly.

**Step 5**

Connect the device cable ④ to the back-end HCVR device. So far, the device installation and cable connection have been completed, you can check monitoring image via rear-end coding device.

**3.4 Installation for model D**

**3.4.1 Installation for Model D1 (with clamping jaw)**

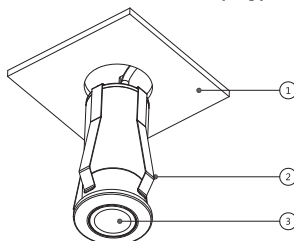

Figure 3-6

**Step 1**

Pull the camera ③ through the installation board ① according to the cable direction, and then fix it on the installation board via clamping jaw ②.

**Step 2**

Paste some glass sealant on the back of the joint between camera and installation board, which is to fix it more firmly.

**Step 3**

Connect the device cable to the back-end HCVR device. For mobile model: Connect aviation head cable to the back-end HCVR device. For general model: Connect the camera BNC cable to the back-end HCVR device, and connect the power port to power. So far, the device installation and cable connection have been completed, you can check monitoring image via back-end encoding device.

**3.4.2 Installation for Model D2 and D3 (with bracket)**

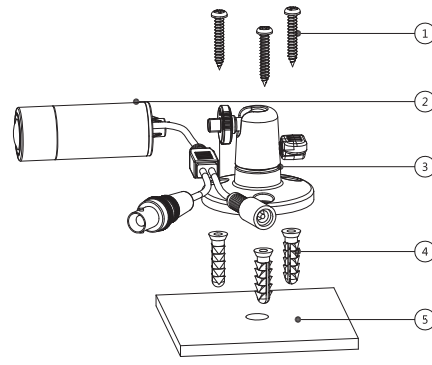

Figure 3-7

**Step 1**

Use tool to fix the expansion bolts ④ on the installation board ⑤.

**Step 2**

Adjust the bracket ③ location. Align the bolt fixing holes of device bracket with the fixing holes of expansion bolts on the installation board; insert the installation screws ① into the expansion bolts and lock them firmly, which is to fix the bracket on the installation board.

**Step 3**

Adjust the camera body ② to a proper position and fix it on the bracket, and then tighten the fixing screws on the bracket firmly.

**Step 4**

Connect the video output port of the device cable to the rear-end HCVR device, and connect the power port of the device cable to the power. So far, the device installation and cable connection have been completed, you can check monitoring image via back-end encoding device.

# 4 Menu

**4.1 HCVR Settings**

This HDCVI camera series can adjust OSD menu via coaxial control. After connected the camera to the HDCVI series HCVR, from Main Menu->Setting->System->PTZ, you need to select the channel number for access and set control mode as HDCVI and the protocol as HD-CVI. Click "Save" button to save current setup. See Figure 4-1.



Figure 4-1

**4.2 Menu Operation**

Click the right mouse button and select "PTZ Control", then you will see the "PTZ Setup" menu, which is as shown in Figure 4-2.

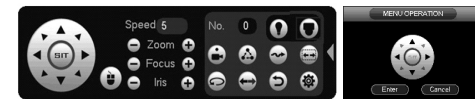

Figure 4-2

See Sheet 4-1 for the details of button functions.

Button	Function
[Enter]	Open menu
[Up/Down]	Select menu item
[Left/Right]	Select menu value

Sheet 4-1

If there is "↓", click the "Confirm" button in "Menu Operation" interface to go to the 2nd menu. Click "Return" button to go back to the previous menu interface. Please use a UTC controller or enter the OSD menu for switchover between HD and SD video output.

## Appendix 1 Maintenance

**Attention:**

Please maintain the device according to the following instructions in order to ensure the image effect and long-term stable operation of the device.

**Maintenance for lens and mirror surface**

The lens and mirror surface are covered with antireflection coating, so it may produce hazardous substance and lead to performance reduction or scratch, dimness etc when it is stained with dust, grease, fingerprint and so on, please refer to the following methods to deal with once dirt is found:

- **Stained with dirt**  
Use oil-free soft brush or hair dries to remove it gently.
- **Stained with grease or fingerprint**  
Use soft cloth to wipe the water drop or oil gently to make it dry, then use oil-free cotton cloth or paper soaked with alcohol or detergent to wipe from the lens center to outward. It is ok to change the cloth and wipe several times if it is not clean enough.
- **Camera Body Maintenance**  
Use a soft dry cloth to clean the camera body when it is dirty, in case the dirt is hard to remove, use a clean dry cloth soaked with mild detergent and wipe gently, make it dry later. Don't use volatile solvent like alcohol, benzene, thinner and etc or strong detergent with abrasiveness, otherwise it will damage the surface coating or reduce the working performance of the device.

**Note:**

- This manual is for reference only. Slight difference may be found in the user interface.
- All the designs and software here are subject to change without prior written notice.
- All trademarks and registered trademarks mentioned are the properties of their respective owners.
- If there is any uncertainty or controversy, please refer to the final explanation of us.
- Please visit our website or contact your local service engineer for more information.