

IOS 0020 A
4.998.137.266

- AL** **Pershkrimi i pajisjes / Manual i instalimit**
20 mA Moduli i komunikimit
- BG** **Описание на продукта / Инструкция за монтаж**
20 mA Комуникационен модул
- CZ** **Popis produktu / Instalační manuál**
Komunikační modul 20 mA
- D** **Produktbeschreibung / Montageanleitung**
Serielles Schnittstellenmodul 20 mA
- DK** **Produktbeskrivelse / Installationsmanual**
20 mA Kommunikationsmodul
- E** **Descripción del Producto / Manual de Instalación**
Módulo de comunicación de 20 mA
- EST** **Toote kirjeldus / Monteerimisjuhised**
20 mA Ühendusmodul
- F** **Description de produit / Manuel d'installation**
Module de communication 20 mA
- FIN** **Tuotekuvaus / Asennusohjeet**
20 mA:n tiedonsiirtomoduuli
- GB** **Product description / Installation manual**
20 mA Communication module
- GR** **Περιγραφή προϊόντος / Οδηγίες συναρμολόγησης**
Δομοστοιχείο επικοινωνίας των 20 mA
- H** **Termékleírás / Telepítési kézikönyv**
20 mA kommunikációs modul
- HR** **Opis proizvoda / Priručnik za instaliranje**
20 mA komunikacijski modul
- I** **Descrizione prodotto / Manuale di installazione**
Modulo di comunicazione 20 mA
- LT** **Gaminio aprašymas / Surinkimo instrukcija**
20 mA komunikacinis modulis
- LV** **Izstrādājuma apraksts / Montāžas norādījumi**
20 mA komunikāciju modulis
- N** **Produktbeskrivelse / Monteringsinstruksoner**
20 mA kommunikasjonsmodul
- NL** **Productomschrijving / Installatiehandleiding**
20 mA communicatiemodules
- P** **Descrição de Produto / Manual de Instalação**
Módulo de comunicações de 20 mA
- PL** **Opis produktu / Instrukcja instalacji**
Moduł komunikacyjny 20 mA
- RO** **Prospecte / Manual de Instalara**
Modul de comunicare 20 mA
- RUS** **Техническое описание / Инструкция по установке**
Коммуникационный модуль 20 mA
- S** **Produkt beskrivning / Installation manual**
20 mA kommunikationsmodul
- SCG** **Opis proizvoda / Instalacijski priručnik**
20 mA komunikacijski modul
- SLO** **Opis izdelka / Priročnik za montažo**
20 mA komunikacijski modul
- TR** **Ürün tanımı / Kurulum kılavuzu**
20 mA İletişim modülü

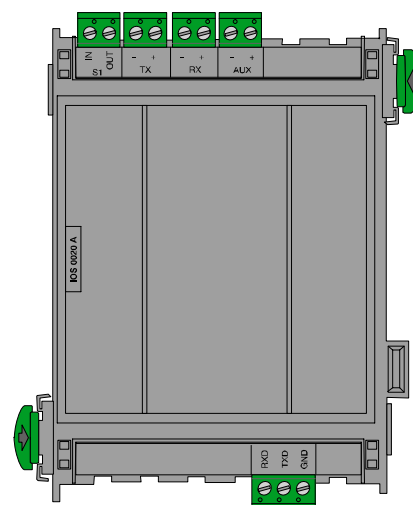

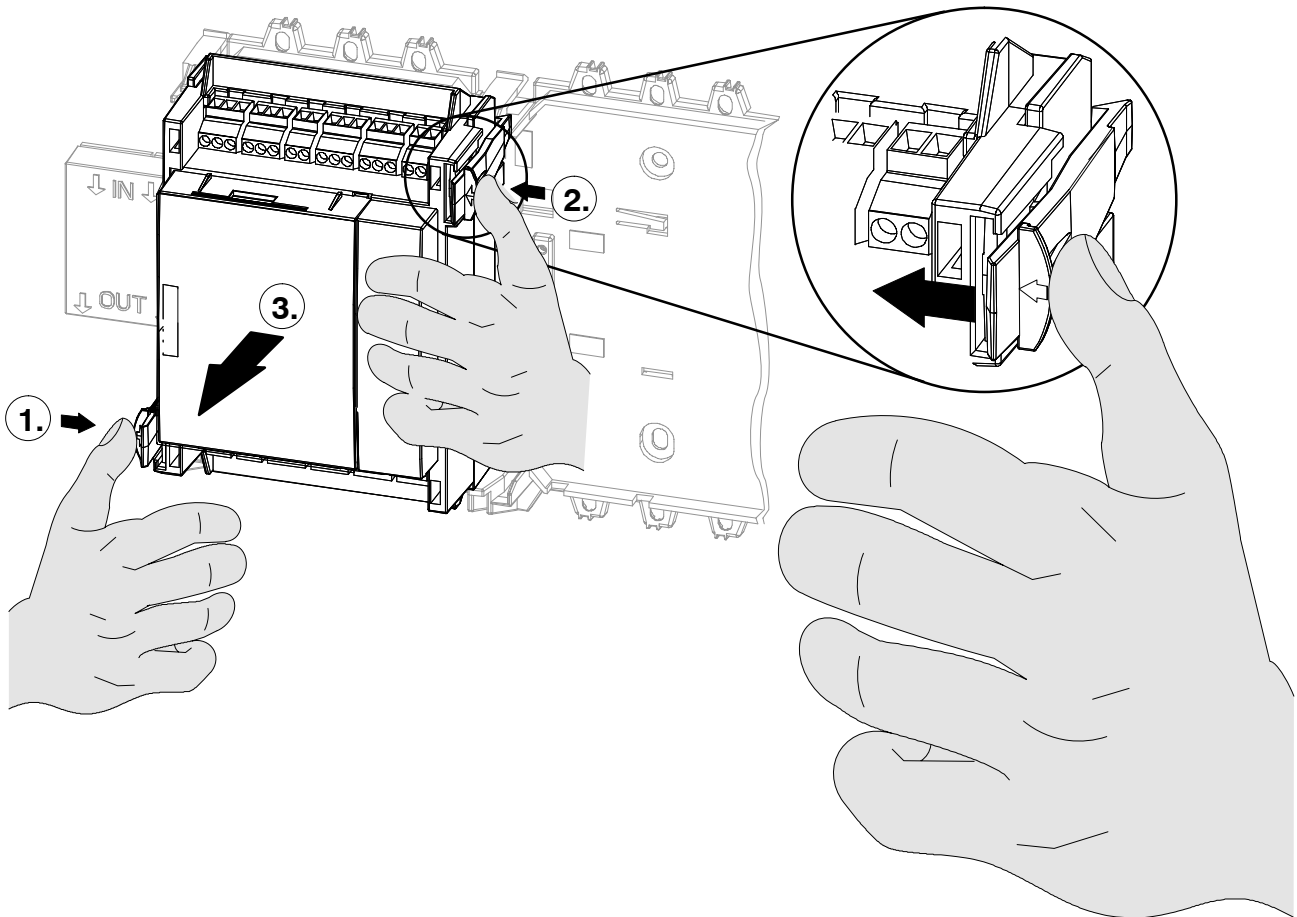
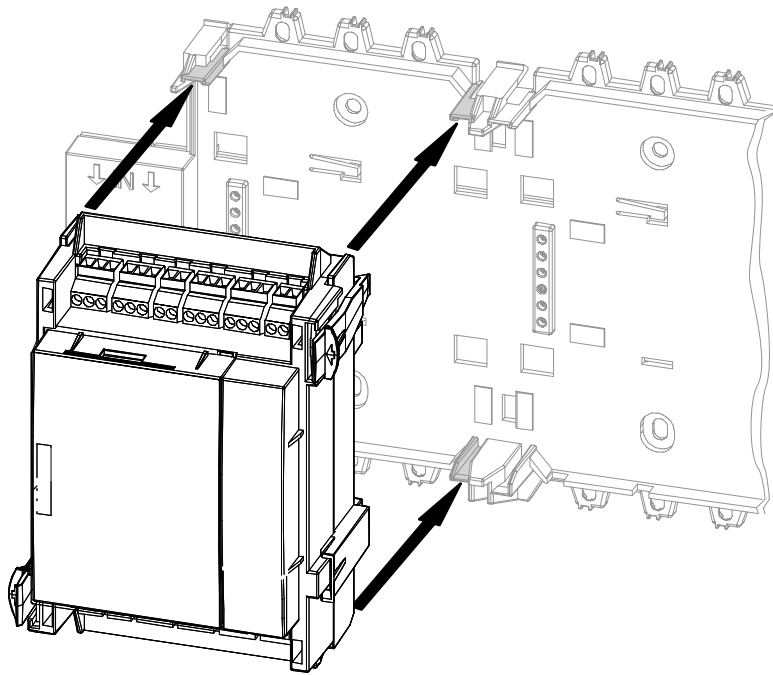

IOS 0020 A ⇒ PRS 0002 A / PRD 0004 A

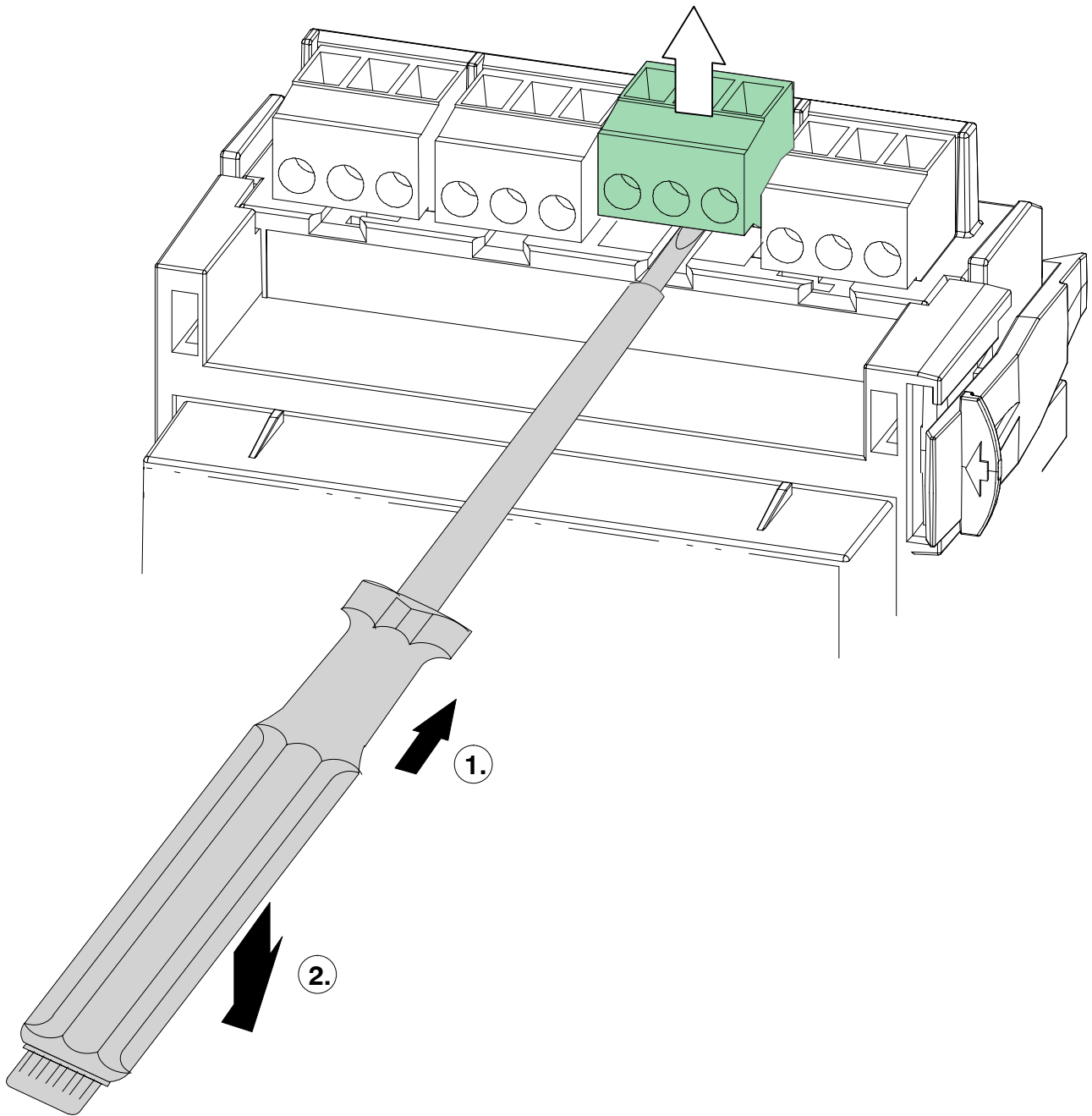

Përshkrimi i funksioneve

- Moduli i komunikimit 20 mA jep një interfaqe S, një interfaqe RS232 dhe një interfaqe 20 mA (cikël rryme) për të lidhur makinën e shtypit (printer) DR 2020.

Rrjeti

Poz.	Marka	Lidhje
1	S1 IN	S1 Interfaqja
2	S1 OUT	
3	TX -	20 mA Interfaqja
4	TX +	
5	RX +	
6	RX -	
7	AUX -	+24 V DC / max. 1,3 A furnizimi me energji
8	AUX +	
20	RXD	RS232 Interfaqja
21	TXD	
22	GND	

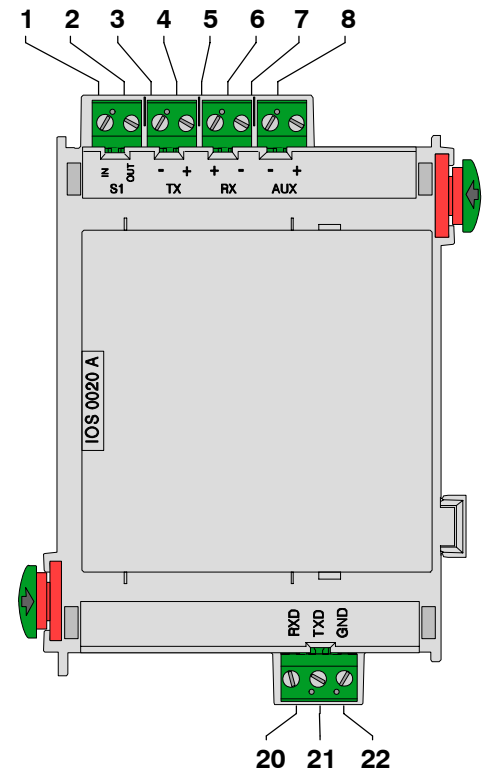

Caktimi-pin i plug-ut DSUB 9-pin

PIN-No.	Lidhje
2	TxD0
3	RxD0
5	GND

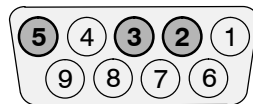

Karakteristika teknike

Tensioni i hyrjes (min. - max.)	20 mA në 24 V DC
max. Konsumi i rrymës	6,9 mA (2,6 mA pa ngarkesë)
max. rryma e daljes	1,3 A në 24 V DC (me 20 mA interfaqe)
Gjatësia maksimale e linjës	1000 m (1093.6 jard)
Klasa e sigurisë	IEC 60950 / EN 60950
Mbrojtja EMI / EMC	EN 50081-1 / FCC Part 15
Klasa e mbrojtjes	IP 30 si për IEC 60529
Temperatura e lejueshme e funksionimit	-5 °C . . . 50 °C (23 °F . . . 122 °F)
Temperatura e lejueshme e magazinimit	-20 °C . . . 60 °C (-4 °F . . . 140 °F)
Lagështia relative e lejueshme	max. 95% nuk kondenson
Materiali dhe ngjyra e folesë	ABS plastik Polylak PA-766 (UL94 V-0), antracit gjysëm i shndritshëm, RAL 7016
Dimensionet (Lart. x Gjer. x Gjat.)	përafërsisht 127 x 96 x 60 mm (7,9 x 3,9 x 1,6 inç)
Pesha	përafërsisht 175 g (6,2 oncë)

Функционално описание

- Комуникационният модул за 20 mA съдържа интерфейс S1, интерфейс RS232 и интерфейс с 20 mA (токов кръг) за свързване с регистрационния принтер DR 2020.

Електрическа монтажна схема

Поз.	Означение	Свързване
1	S1 IN	Интерфейс S1
2	S1 OUT	
3	TX -	Интерфейс 20 mA
4	TX +	
5	RX +	
6	RX -	+24 V DC / макс. 1,3 A захранване
7	AUX -	
8	AUX +	
20	RXD	Интерфейс RS232
21	TXD	
22	GND	

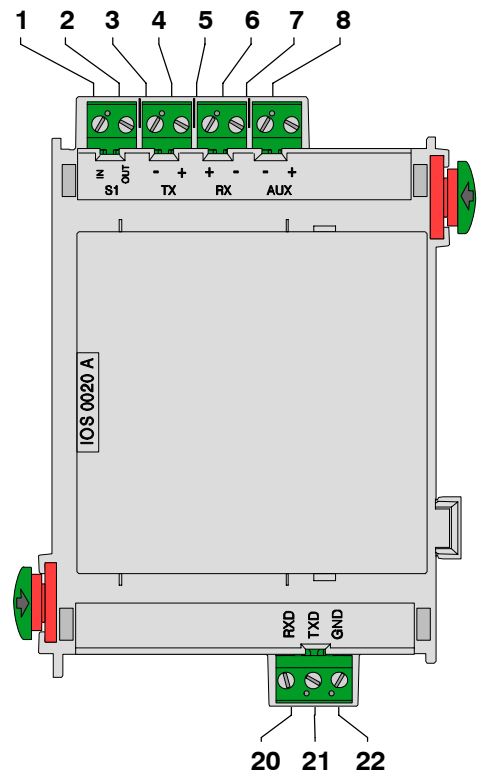

Предназначение на крачетата на 9-изводен щепсел DSUB

Краче №	Свързване
2	TxD0
3	RxD0
5	GND

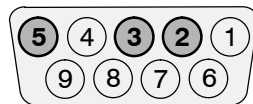

Техническа спецификация

Входно напрежение (мин. - макс.)	20 V DC - 30 V DC
Макс. потребление на ток	6,9 mA (2,6 mA без товар)
Макс. изходен ток	1,3 A при 24 V DC (на интерфейса 20 mA)
Максимална дължина на линията	1000 м
Клас на безопасност	II съгласно IEC 60950 / EN 60950
Защита за EMI / EMC	EN 50081-1 / FCC Част 15
Клас на защита	IP 30 съгласно IEC 60529
Работна температура	-5 °C ... 50 °C (23 °F ... 122 °F)
Температура на съхранение	-20 °C ... 60 °C (-4 °F ... 140 °F)
Допустима относителна влажност	макс. 95% без кондензация
Материал и цвят на корпуса	ABS пластмаса Polyloc PA-766 (UL94 V-0), полугланцов антрацит, RAL 7016
Размери (В x Ш x Д)	прибл. 127 x 96 x 60 мм
Тегло	прибл. 175 г

Popis funkcí

- 20 mA komunikační modul je vybaven rozhraním S1, rozhraním RS232 a 20 mA rozhraním (proudový okruh) pro připojení tiskárny protokolů DR 2020.

Kabeláž

Poz.	Označení	Připojení
1	S1 IN	rozhraní S1
2	S1 OUT	
3	TX -	rozhraní 20 mA
4	TX +	
5	RX +	
6	RX -	
7	AUX -	+24 V stejnosměr. / max. 1,3 A napájení
8	AUX +	
20	RXD	rozhraní RS232
21	TXD	
22	GND	

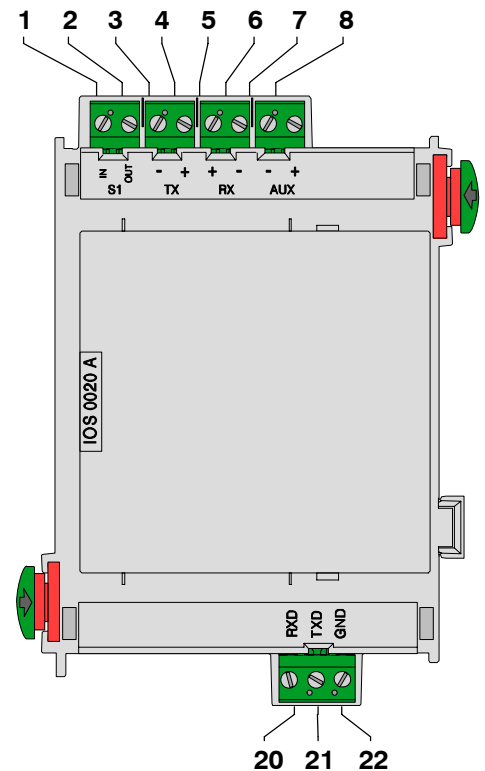

Obsazení kolíků DSUB - 9 kolíková zástrčka

Č. kolíku	Připojení
2	TxD0
3	RxD0
5	GND

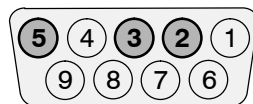

Technické údaje

Vstupní napětí (min. - max.)	20 V stejnosm. - 30 V stejnosm.
Max. spotřeba proudu	6,9 mA (2,6 mA bez zatížení)
Max. výstupní proud	1,3 A při 24 V stejnosm. (při rozhraní 20 mA)
Maximální délka linky	1000 m
Třída bezpečnosti	II podle IEC 60950 / EN 60950
Ochrana EMI / EMC	EN 50081-1 / FCC Část 15
Krytí	IP 30 podle IEC 60529
Provozní teplota	-5 °C . . . 50 °C
Skladovací teplota	-20 °C . . . 60 °C
Přípustná relativní vlhkost	maximálně 95% nekondenzující
Materiál a barva krytu	plast ABS Polylac PA-766 (UL94 V-0), pololesklá antracitová, RAL 7016
Rozměry (v x š x h)	přibl. 127 mm x 96 mm x 60 mm
Hmotnost	přibl. 175 g

Funktionsbeschreibung

Das 20 mA Schnittstellenmodul verfügt über eine S1 Schnittstelle, eine RS232 Schnittstelle und eine S20 Schnittstelle (zum Anschalten des DR 2020 Protokolldruckers).

Klemmenbelegung

Pos.	Beschr.	Anschluß
1	S1 IN	S1 Schnittstelle
2	S1 OUT	
3	TX -	20 mA Schnittstelle
4	TX +	
5	RX +	
6	RX -	
7	AUX -	Spannungsversorgung +24 V DC / max. 1,3 A
8	AUX +	
20	RXD	RS232 Schnittstelle
21	TXD	
22	GND	

Belegung des DSUB 9-Steckers

PIN-Nr.	Anschluß
2	TxD0
3	RxD0
5	GND

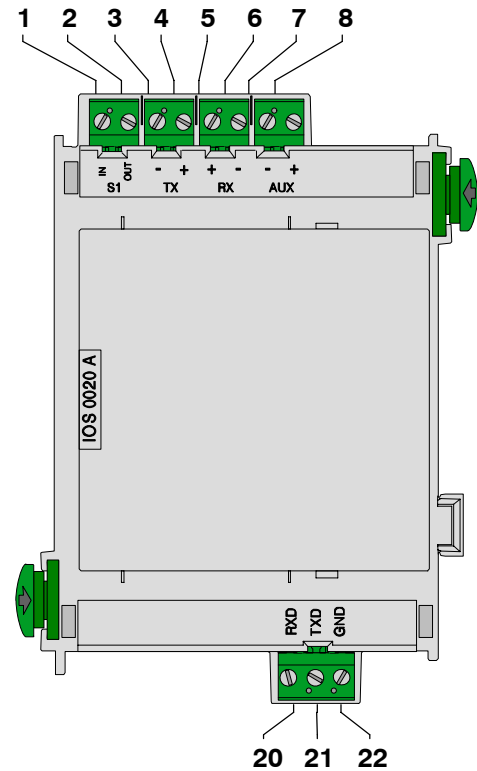
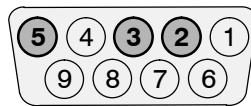

Technische Daten

Eingangsspannung (min - max)	20 V DC - 30 V DC / 5 V DC \pm 5%
Maximale Stromaufnahme	6,9 mA (2,6 mA ohne Verbraucher)
Maximaler Ausgangsstrom	1,3 A bei 24 V DC (an der 20 mA schnittstelle)
Maximale Leitungslänge	1000 m (1093.6 yards)
Sicherheitsklasse	II nach IEC 60950 / EN 60950
EMV-Störfestigkeit	EN 50130-4 / FCC Part 15
EMV-Störaussendung	EN 50081-1 / FCC Part 15
Schutzklasse	IP 30 nach IEC 60529
Zulässige Betriebstemperatur	-5 °C ... 50 °C (23 °F ... 122 °F)
Zulässige Lagertemperatur	-20 °C ... 60 °C (-4 °F ... 140 °F)
Zulässige relative Feuchte	max. 95% nicht kondensierend
Gehäusematerial und Farbe	ABS Kunststoff, Polylac PA-766 (UL94 V-0), seidenmatt anthrazit, RAL 7016
Abmessungen (H x B x T)	ca. 127 x 96 x 60 mm (5.0 x 3.8 x 2.4 inches)
Gewicht	ca. 150 g (5.3 ounces)
Abmessungen(H x B x T)	ca. 127 x 96 x 60 mm (5.0 x 3.8 x 2.4 inches)
Gewicht	ca. 175 g (6.2 ounces)

Funktionsbeskrivelse

- 20 mA kommunikationsmodulet har et S1-stik, et RS232-stik og et 20 mA (strømloop)-stik til forbindelse til DR 2020 log-printeren.

Kabelføring

Pos.	Afmærkning	Tilslutning
1	S1 IN	S1-stik
2	S1 OUT	
3	TX -	20 mA-stik
4	TX +	
5	RX +	
6	RX -	
7	AUX -	+24 V DC / maks. 1,3 A strømforsyning
8	AUX +	
20	RXD	RS232-stik
21	TXD	
22	GND	

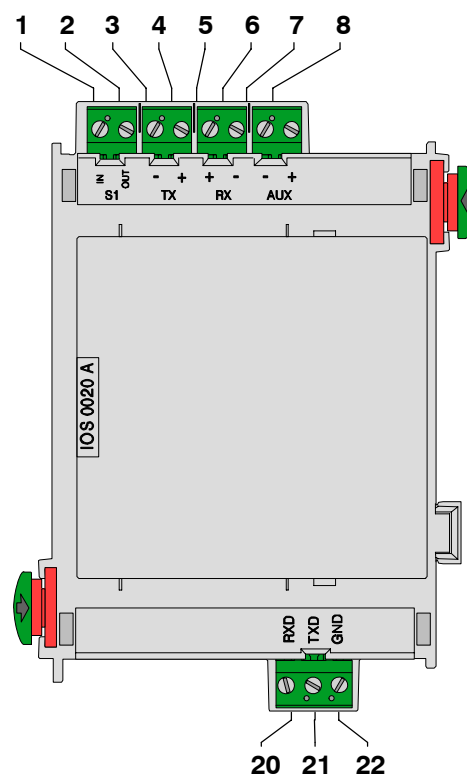

Ben-tildeling ved et DSUB 9-bens stik

BEN-Nr.	Tilslutning
2	TxD0
3	RxD0
5	GND

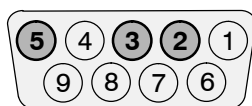

Tekniske specifikationer

Indgangsspænding (min. - maks.)	20 V DC - 30 V DC
Maks. strømforbrug	6,9 mA (2,6 mA uden belastning)
Maks. udgangsstrøm	1,3 A ved 24 V DC (ved 20 mA-stik)
Maks. linjelængde	1000 m (1093,6 yards)
Sikkerhedsklasse	II i henhold til IEC 60950 / EN 60950
EMI / EMC beskyttelse	EN 50081-1 / FCC del 15
Beskyttelsesklasse	IP 30 i henhold til IEC 60529
Driftstemperatur	-5 °C . . . 50 °C
Opbevaringstemperatur	-20 °C . . . 60 °C
Tilladt relativ luftfugtighed	maks. 95% ikke kondenserende
Kabinetmateriale og -farve	ABS plast Polylac PA-766 (UL94 V-0), halvglans antracit, RAL 7016
Dimensioner (H x B x D)	ca. 127 x 96 x 60 mm
Vægt	ca. 175 g

Descripción de las funciones

- El módulo de comunicación de 20 mA proporciona una interfaz S1, una interfaz RS232 y una interfaz de 20 mA (lazo de corriente) para conectar la impresora de registros DR 2020.

Cableado

Pos.	Marcación	Conexión
1	S1 IN	Interfaz S1
2	S1 OUT	
3	TX -	Interfaz 20 mA
4	TX +	
5	RX +	
6	RX -	
7	AUX -	+24 V DC / máx. 1,3 A fuente de alimentación
8	AUX +	
20	RXD	Interfaz RS232
21	TXD	
22	GND	

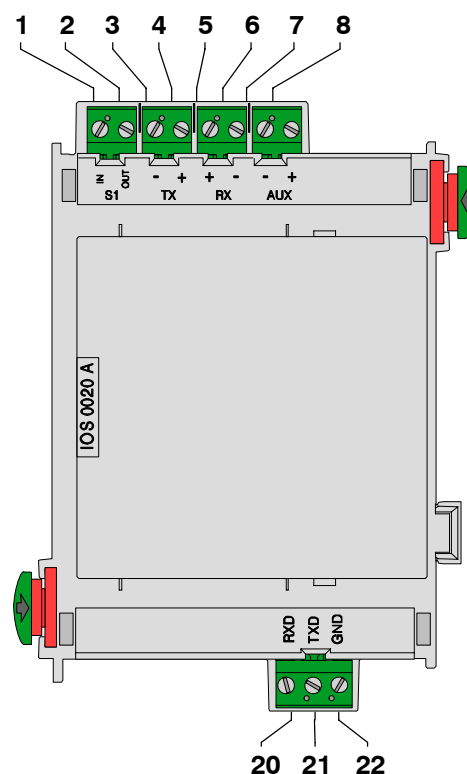

Asignación de clavijas del enchufe DSUB de 9 clavijas

CLAVIJA-Nº	Conexión
2	TxD0
3	RxD0
5	GND

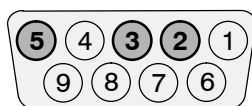

Especificaciones técnicas

Tensión de entrada (mín. - máx.)	20 V DC - 30 V DC
Máx. Consumo de corriente	6,9 mA (2,6 mA sin carga)
Corriente de salida máx.	1,3A a 24V DC (en la interfaz de 20 mA)
Longitud de línea máxima	1000 m (1093,6 yardas)
Clase de seguridad	II según IEC 60950 / EN 60950
Protección EMI / EMC	EN 50081-1 / FCC Parte 15
Clase de protección	IP 30 según IEC 60529
Temperatura de funcionamiento	-5 °C ... 50 °C (23 °F ... 122 °F)
Temperatura de almacenamiento	-20 °C ... 60 °C (-4 °F ... 140 °F)
Humedad relativa permitida	máx. 95% sin condensación
Material y color de la carcasa	Plástico ABS Polydac PA-766 (UL94 V-0), antracita semibrillante, RAL 7016
Dimensiones (A x A x P)	aprox. 127 x 96 x 60 mm (5,0 x 3,8 x 2,4 pulgadas)
Peso	aprox. 175 g (6,2 onzas)

Funktsionaalne kirjeldus

- 20 mA kommunikatsioonimoodul omab S1 liidest, RS232 liidest ning 20 mA (vooluring) liidest DR 2020 logi printeri ühendamiseks.

Juhtmete ühendamine

Jrk. nr.	Markeering	Liides
1	S1 IN	S1 Liides
2	S1 OUT	
3	TX	20 mA liides
4	TX +	
5	RX +	
6	RX	+24 V DC / maks. 1,3 A Toide
7	AUX -	
8	AUX +	RS232 Liides
20	RXD	
21	TXD	
22	GND	

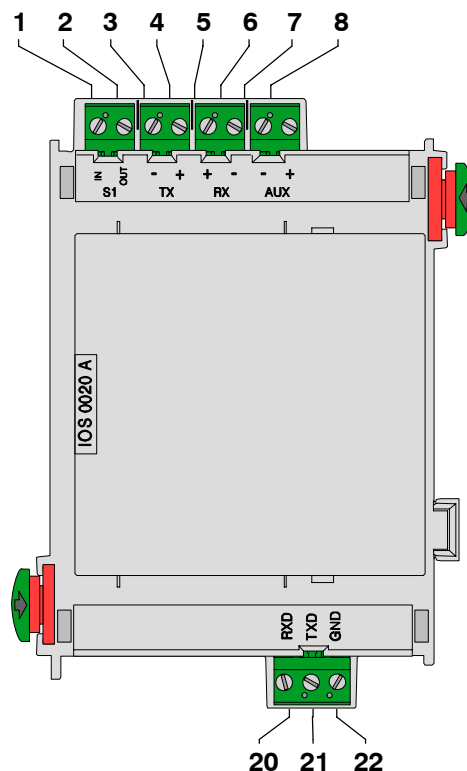

Kontaktide järjekord DSUB 9 pistikul

Kontakti nr.	Liides
2	TxD0
3	RxD0
5	GND

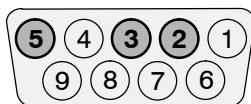

Tehniline kirjeldus

Sisendpinge (min. - maks.)	20 V DC - 30 V DC
Maks. voolutarve	6,9 mA (2,6 mA koormuseta)
Maks. väljundpinge	1,3 A vooluringel 24 V DC (20 mA liidesel)
Maksimaalne juhtmepikkus	1000 m (1093,6 tolli)
Ohutusklass	II vastavalt IEC 60950 / EN 60950
EMI / EMC kaitse	EN 50081-1 / FCC Osa 15
Kaitseklass	IP 30 vastavalt IEC 60529
Käitamistemperatuur	-5 °C ... 50 °C (23 °F ... 122 °F)
Ladustamistemperatuur	-20 °C ... 60 °C (-4 °F ... 140 °F)
Lubatud suhteline niiskus	Maks. 95% mitte-kondenseeruv
Kaitseümbrise materjal ning värvus	ABS plastik Polyloc PA-766 (UL94 V-0), poolläikiv antratsiit, RAL 7016
Mõõtmed (Kõrgus x Laius x Sügavus)	Umbes 127 x 96 x 60 mm (5,0 x 3,8 x 2,4 tolli)
Kaal	Umbes 175 g (6,2 untsi)

Description fonctionnelle

- Le module de communication 20 mA fournit une interface S1, une interface RS232 et une interface 20 mA (boucle de courant) pour connecter l'imprimante DR 2020.

Câblage

N°	Marquage	Connexion
1	S1 IN	Interface S1
2	S1 OUT	
3	TX -	Interface 20 mA
4	TX +	
5	RX +	
6	RX -	Alimentation +24 V c.c. / max. 1,3 A
7	AUX -	
8	AUX +	Interface RS232
20	RXD	
21	TXD	
22	GND	

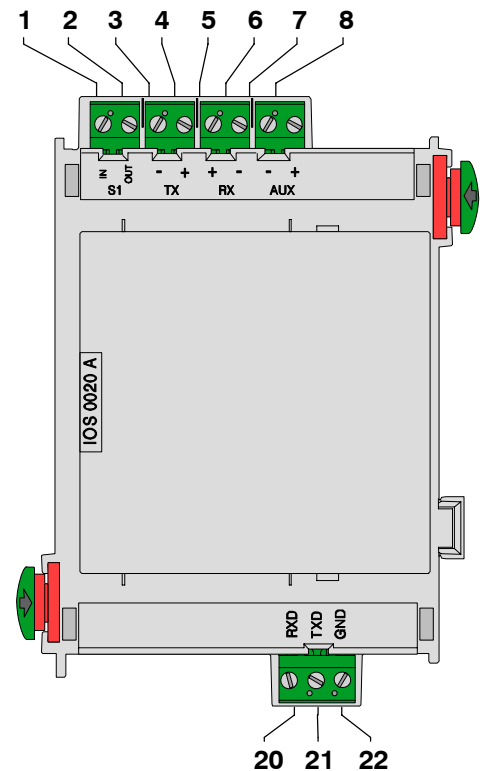

Affectation des broches de la fiche à 9 broches DSUB

N° broche	Connexion
2	TxD0
3	RxD0
5	GND

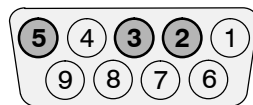

Caractéristiques techniques

Tension d'entrée (min. - max.)	20 - 30 V c.c.
Consommation de courant max.	6,9 mA (2,6 mA sans charge)
Courant de sortie max.	1,3 A à 24 V c.c. (sur l'interface 20 mA)
Longueur de ligne maximale	1000 m (1093,6 yards)
Classe de sécurité	II conformément à CEI 60950 / EN 60950
Protection EMI / CEM	EN 50081-1 / FCC partie 15
Classe de protection	IP 30 conformément à CEI 60529
Température de fonctionnement	-5 °C ... 50 °C (23 °F ... 122 °F)
Température de stockage	-20 °C ... 60 °C (-4 °F ... 140 °F)
Taux d'humidité relative admissible	max. 95 % sans condensation
Matière et couleur du boîtier	Plastique ABS Polyac PA-766 (UL94 V-0), anthracite semi-brillant, RAL 7016
Dimensions (H x l x P)	env. 127 x 96 x 60 mm (5,0 x 3,8 x 2,4 pouces)
Poids	env. 175 g (6,2 onces)

Toiminnan kuvaus

- 20 mA:n tiedonsiirtomodulissa on S1-liitäntä, RS232-liitäntä ja 20 mA:n (virtasilmutka) liitäntä DR 2020 -lokitulostimen liittämistä varten.

Johdotus

Tunnus	Merkintä	Liitäntä
1	S1 IN	S1-liitäntä
2	S1 OUT	
3	TX -	20 mA:n liitäntä
4	TX +	
5	RX +	
6	RX -	
7	AUX -	+24 V DC / maks. 1,3 A virtalähde
8	AUX +	
20	RXD	RS232-liitäntä
21	TXD	
22	GND	

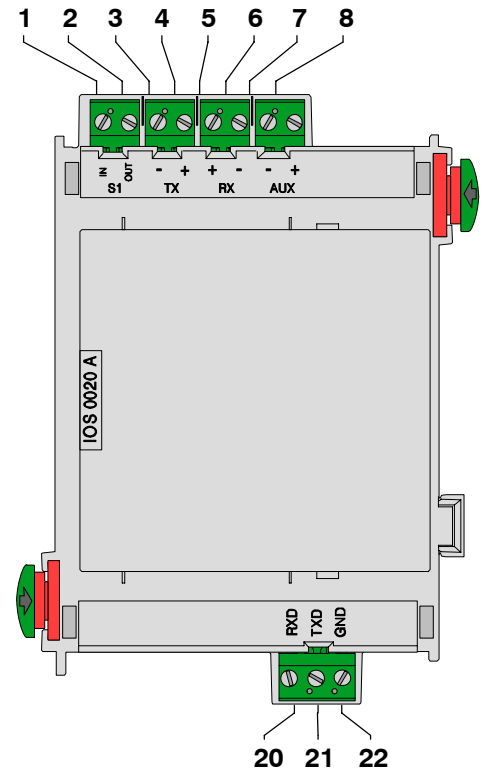

DSUB 9-nastaisen pistokkeen nastajärjestys

Nastanro	Liitäntä
2	TxD0
3	RxD0
5	GND

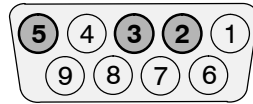

Tekniset tiedot

Tulojännite (min. - maks.)	20 V DC - 30 V DC
Virrankulutus enintään	6,9 mA (2,6 mA ilman kuormitusta)
Ulostulovirta enintään	1,3 A (24 V DC) (20 mA:n liitäntä)
Linjan enimmäispituus	1000 m
Turvallisuusluokitus	II, IEC 60950 / EN 60950 mukaisesti
EMI / EMC-suojaus	EN 50081-1 / FCC Part 15
Suojausluokitus	IP 30, IEC 60529 mukaisesti
Käyttölämpötila	-5 °C... 50 °C (23 °F... 122 °F)
Säilytyslämpötila	-20 °C... 60 °C (-4 °F... 140 °F)
Suhteellinen kosteus	enintään 95 % (tiivistymätön)
Kotelon materiaali ja väri	ABS-muovi, Polyloc PA-766 (UL94 V-0) puolikiiltävä anthrazit, RAL 7016
Mitat (K x L x S)	noin 127 x 96 x 60 mm
Paino	noin 175 g

Functional description

- The 20 mA communication module provides a S1 interface, a RS232 interface and a 20 mA (current loop) interface to connect the DR 2020 log printer.

Wiring

Pos.	Marking	Connection
1	S1 IN	S1 Interface
2	S1 OUT	
3	TX -	20 mA Interface
4	TX +	
5	RX +	
6	RX -	
7	AUX -	+24 V DC / max. 1,3 A power supply
8	AUX +	
20	RXD	RS232 Interface
21	TXD	
22	GND	

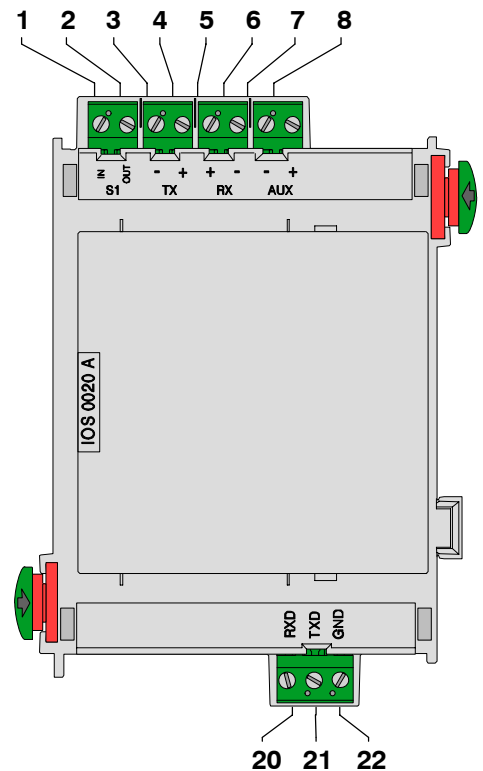

Pin-assignment of DSUB 9-pin plug

PIN-No.	Connection
2	TxD0
3	RxD0
5	GND

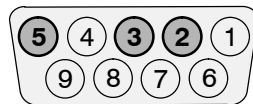

Technical Specification

Input voltage (min - max)	20 V DC - 30 V DC
Max. current consumption	6.9 mA (2.6 mA without load)
Max. output current	1,3 A at 24 V DC (at the 20 mA interface)
Maximum length of line	1000 m (1093.6 yards)
Safety class	II as per IEC 60950 / EN 60950
EMI / EMC protection	EN 50081-1 / FCC Part 15
Protection class	IP 30 as per IEC 60529
Operating Temperature	-5 °C ... 50 °C (23 °F ... 122 °F)
Storage Temperature	-20 °C ... 60 °C (-4 °F ... 140 °F)
Permissible relative humidity	max. 95% non condensing
Housing material and color	ABS plastic Polyac PA-766 (UL94 V-0), semi gloss anthracite, RAL 7016
Dimensions (H x W x D)	approx. 127 x 96 x 60 mm (5.0 x 3.8 x 2.4 inches)
Weight	approx. 175 g (6.2 ounces)

Περιγραφή λειτουργίας

- Το δομοστοιχείο επικοινωνίας 20 mA αποτελεί μια διασύνδεση S1, μια διασύνδεση RS232 και μια διασύνδεση 20 mA (βρόχος ρεύματος) για τη σύνδεση εκτυπωτή καταγραφής DR 2020.

Καλωδίωση

Θέση.	Σήμανση	Σύνδεση
1	S1 IN	Διασύνδεση S1
2	S1 OUT	
3	TX -	Διασύνδεση 20 mA
4	TX +	
5	RX +	
6	RX -	
7	AUX -	+24 V DC / μέγ. 1,3 A παροχή ρεύματος
8	AUX +	
20	RXD	Διασύνδεση RS232
21	TXD	
22	GND	

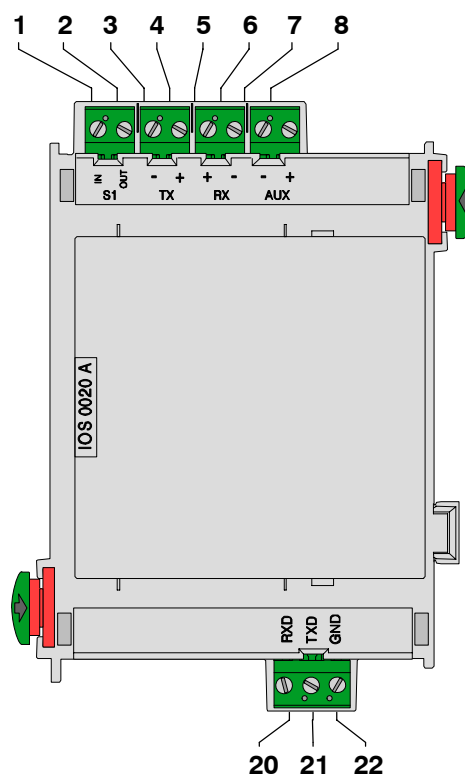

Αντιστοιχία ακίδων του βύσματος DSUB 9 ακίδων

Αρ. ΑΚΙΔΑΣ	Σύνδεση
2	TxD0
3	RxD0
5	GND

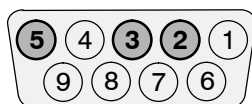

Τεχνικές προδιαγραφές

Τάση εισόδου (ελάχ. - μέγ.)	20 V DC - 30 V DC
Μέγ. κατανάλωση ρεύματος	6,9 mA (2,6 mA χωρίς φορτίου)
Μέγ. ρεύμα εξόδου	1,3 A στα 24 V DC (στη διασύνδεση 20 mA)
Μέγιστο μήκος γραμμής	1000 m (1093,6 γυάρδες)
Κατηγορία ασφαλείας	II κατά IEC 60950 / EN 60950
Προστασία EMI / EMC	EN 50081-1 / FCC Μέρος 15
Κατηγορία προστασίας	IP 30 κατά IEC 60529
Θερμοκρασία λειτουργίας	-5 °C . . . 50 °C (23 °F . . . 122 °F)
Θερμοκρασία αποθήκευσης	-20 °C . . . 60 °C (-4 °F . . . 140 °F)
Επιτρεπτή σχετική υγρασία	Μέγ. 95% μη συμπυκνούμενη
Υλικό κατασκευής και χρώμα περιβλήματος	Πλαστικό ABS Polylac PA-766 (UL94 V-0), ημι-γυαλιστερό ανθρακί, RAL 7016
Διαστάσεις (Υ x Π x Β)	περ. 127 x 96 x 60 mm (5,0 x 3,8 x 2,4")
Βάρος	περ. 175 g (6,2 ounces)

A működés ismertetése

- A 20 mA-es kommunikációs modul a DR 2020 naplónyomtató számára egy S1, egy RS232 és egy 20 mA (áramág) interfészt biztosít.

Vezetékezés

Poz.	Jelzés	Csatlakozás
1	S1 IN	S1 interfész
2	S1 OUT	
3	TX -	20 mA interfész
4	TX +	
5	RX +	
6	RX -	
7	AUX -	+24 V egyenáram / max. 1,3 A tápellátás
8	AUX +	
20	RXD	RS232 interfész
21	TXD	
22	GND	

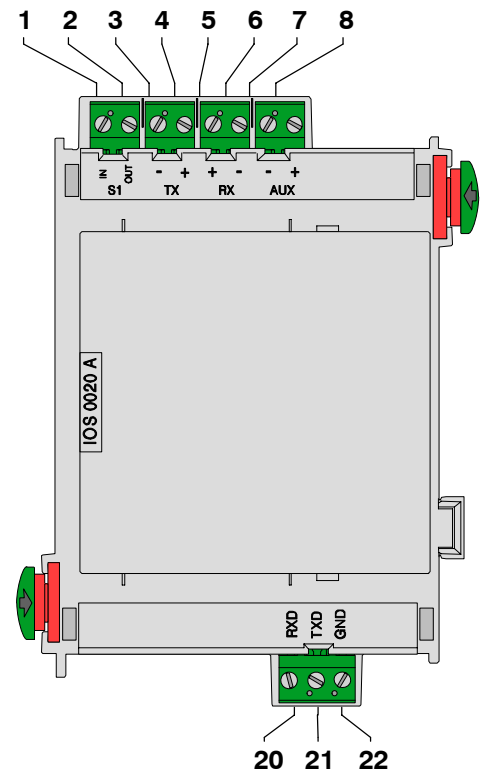

DSUB 9-pólusú csatlakozó dugó lábkiosztása

Érintkező száma	Csatlakozás
2	TxD0
3	RxD0
5	GND

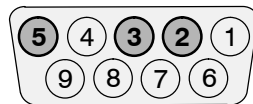

Műszaki adatok

Bemenő feszültség (min. - max.)	20 V egyenáram - 30 V egyenáram
Max. áramfelvétel	6,9 mA (2,6 mA terhelés nélkül)
Max. kimenő áram	1,3 A 24 V egyenáram mellett (a 20 mA-es interfészen)
Vonal maximális hossza	1000 m
Biztonsági osztály	II az IEC 60950 / EN 60950 szerint
EMI / EMC-védelem	EN 50081-1 / FCC 15. rész
Védettség	IP 30 az IEC 60529 szerint
Üzemi hőmérséklet	-5 °C . . . 50 °C
Tárolási hőmérséklet	-20 °C . . . 60 °C
Megengedett relatív páratartalom	max. 95% nem lecsapódó
Ház anyaga és színe	ABS műanyag Polylac PA-766 (UL94 V-0), félfényes antracit, RAL 7016
Méretetek (mag. x szél. x mélys.)	kb. 127 x 96 x 60 mm
Súly	kb. 175 g

Opis funkcija

- Komunikacijski modul 20 mA sadrži S1 sučelje, RS232 sučelje i 20 mA (zatvoreni strujni krug) sučelje za spajanje DR 2020 pisača zapisnika.

Ožičenje

Pol.	Oznaka	Priključak
1	S1 IN	S1 sučelje
2	S1 OUT	
3	TX -	20 mA sučelje
4	TX +	
5	RX +	
6	RX -	
7	AUX -	+24 V DC / maks. 1,3 A napajanje
8	AUX +	
20	RXD	RS232 sučelje
21	TXD	
22	GND	

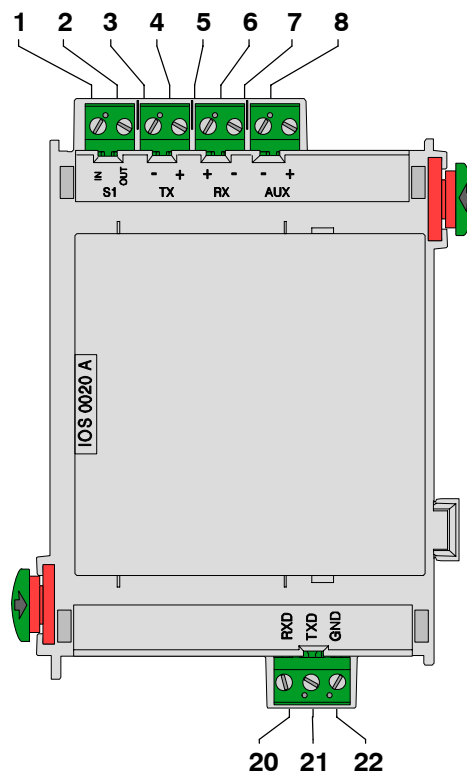

Dodjela pina za DSUB 9 priključak za pin

Broj PIN-a	Priključak
2	TxD0
3	RxD0
5	GND

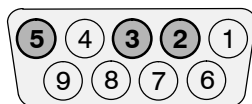

Tehničke specifikacije

Napon ulaza (min - maks)	20 V DC - 30 V DC
Maks. potrošnja električne energije	6,9 mA (2,6 mA bez opterećenja)
Maks. izlazna električna energija	1,3 A pri 24 V DC (kod sučelja od 20 mA)
Maksimalna duljina voda	1000 m (1093,6 jarda)
Sigurnosna klasa	II po IEC 60950 / EN 60950
EMI / EMC zaštita	EN 50081-1 / FCC dio 15
Zaštitna klasa	IP 30 po IEC 60529
Radna temperatura	-5 °C ... 50 °C (23 °F ... 122 °F)
Temperatura za skladištenje	-20 °C ... 60 °C (-4 °F ... 140 °F)
Dopuštena relativna vlažnost	maks. 95% bez kondenzacije
Materijal i boja kućišta	ABS plastika Polylac PA-766 (UL94 V-0), polusjajni antracit, RAL 7016
Dimenzije (V x Š x D)	oko 127 x 96 x 60 mm (5,0 x 3,8 x 2,4 inča)
Težina	oko 175 g (6,2 unci)

Descrizione funzionale

- Il modulo di comunicazione 20 mA dispone di un'interfaccia S1, un'interfaccia RS232 e un'interfaccia 20 mA (circuito di corrente) per il collegamento alla stampante eventi DR 2020.

Cablaggio

Pos.	Contrassegno	Collegamento
1	S1 IN	Interfaccia S1
2	S1 OUT	
3	TX -	Interfaccia 20 mA
4	TX +	
5	RX +	
6	RX -	
7	AUX -	+24 V CC / max. 1,3 A Alimentazione
8	AUX +	
20	RXD	Interfaccia RS232
21	TXD	
22	GND	

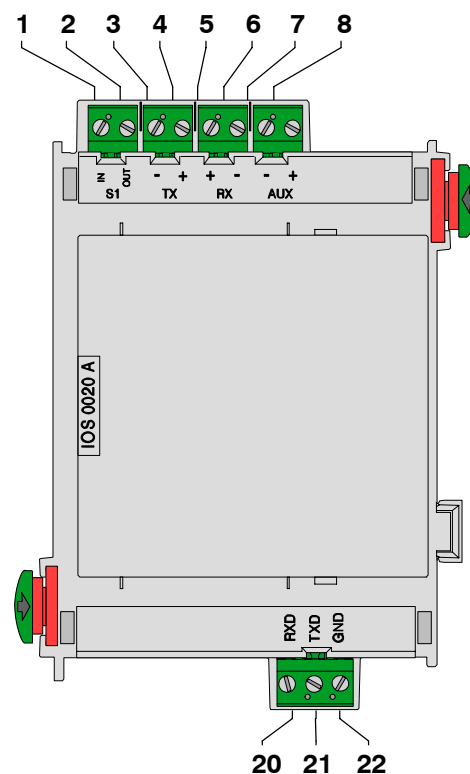

Assegnazione pin di un connettore SUB-D a 9 pin

N. PIN	Collegamento
2	TxD0
3	RxD0
5	GND

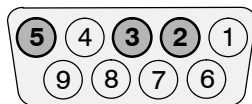

Specifiche tecniche

Tensione di ingresso (min - max)	20 V CC - 30 V CC
Consumo di corrente max.	6,9 mA (2,6 mA senza carico)
Corrente di uscita max.	1,3 A a 24 V CC (sull'interfaccia 20 mA)
Lunghezza max. linea	1000 m
Classe di sicurezza	II come previsto dalle norme IEC 60950 / EN 60950
Protezione EMI/EMC	EN 50081-1 / FCC Parte 15
Grado di protezione	IP 30 come previsto dalla norma IEC 60529
Temperatura operativa	-5 °C ... 50 °C (23 °F ... 122 °F)
Temperatura di stoccaggio	-20 °C ... 60 °C (-4 °F ... 140 °F)
Umidità relativa consentita	max. 95% senza condensa
Materiale e colore custodia	plastica ABS Polylac PA-766 (UL94 V-0), antracite semilucida, RAL 7016
Dimensioni (A x L x P)	circa 127 x 96 x 60 mm
Peso	circa 175 g

Funkcijų aprašymas

- 20 mA komunikaciniame modulyje yra S, RS232 ir 20 mA (kontūras) sąsaja, per kurią jungiamas DR 2020 spausdintuvas.

Laidai

Poz.	Žyma	Jungtis
1	S1 IN	S1 sąsaja
2	S1 OUT	
3	TX -	20 mA sąsaja
4	TX +	
5	RX +	
6	RX -	
7	AUX -	+24 V pastovi srovė / maks. 1,3 A maitinimas
8	AUX +	
20	RXD	RS232 sąsaja
21	TXD	
22	GND	

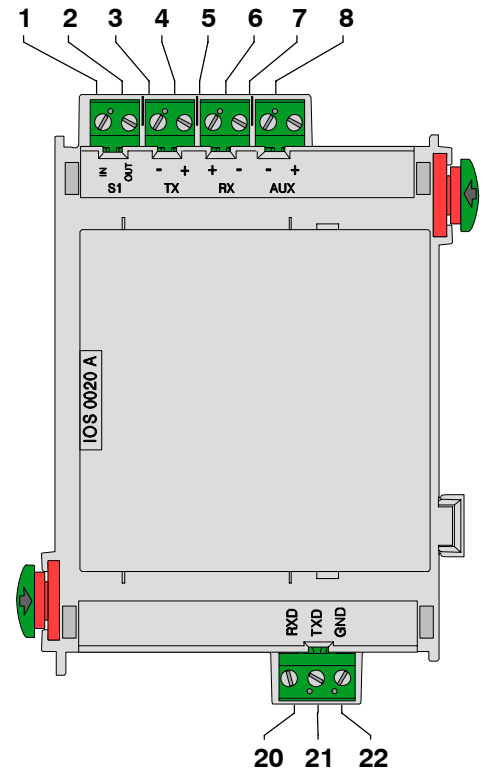

Pin priskyrimas įjungus DSUB 9 pin

PIN Nr.	Jungtis
2	TxD0
3	RxD0
5	GND

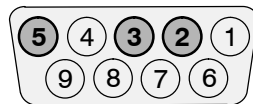

Techninės specifikacijos

Įėjimo įtampa (min. - maks.)	20 V - 30 V (pastovios srovės)
Maks. srovės sunaudojimas	6,9 mA (2,6 mA be krūvio)
Maks. išeinanti srovė	1,3 A esant 24 V pastoviai srovei (20 mA sąsajai)
Maksimalus linijos ilgis	1000 m
Saugos klasė	II pagal IEC 60950 / EN 60950
EMI / EMC sauga	EN 50081-1 / FCC 15 dalis
Saugos klasė	IP 30 pagal IEC 60529
Veikimo temperatūra	-5 °C ... 50 °C (23 °F ... 122 °F)
Laikymo temperatūra	-20 °C ... 60 °C (-4 °F ... 140 °F)
Leistina santykinė drėgmė	maks. 95% nesikondensuoja
Korpuso medžiaga ir spalva	ABS plastikas Polylac PA-766 (UL94 V-0), pusiau blizgus antracitas, RAL 7016
Dydžiai (aukštis x plotis x gylis)	apie 127 x 96 x 60 mm
Svoris	apie 175 g

Funkcionālais apraksts

- 20 mA komunikāciju modulis nodrošina ar S1 interfeisu, RS232 interfeisu un 20 mA (sprieguma kontūrs) interfeisu, lai varētu pieslēgties DR 2020 žurnāla printerim.

Vadojums

Pozīcija	Marķējums	Savienojums
1	S1 IN	S1 interfeiss
2	S1 OUT	
3	TX -	20 mA interfeiss
4	TX +	
5	RX +	
6	RX -	+24 V DC / max. 1,3 A strāvas padeve
7	AUX -	
8	AUX +	RS232 interfeiss
20	RXD	
21	TXD	
22	GND	

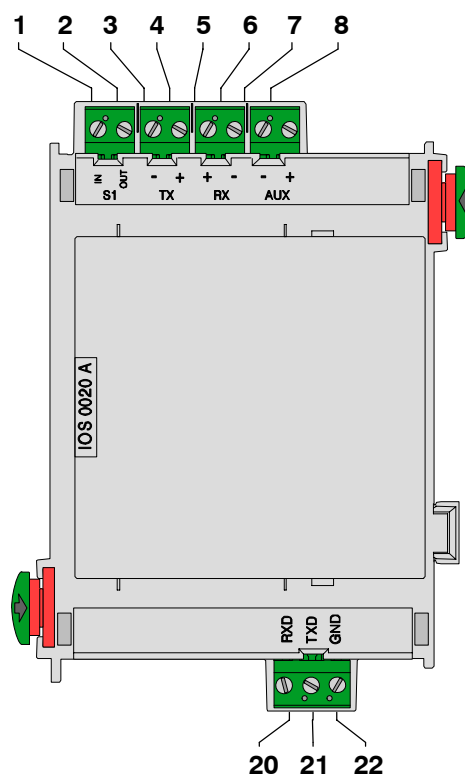

DSUB 9 spraudņu kontakta spraudņu nozīme

Spraudnis Nr.	Savienojums
2	TxD0
3	RxD0
5	GND

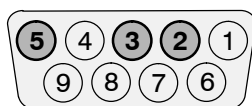

Tehniskā specifikācija

Ieejas spriegums (minimālais - maksimālais)	20 V DC - 30 V DC
Maks. strāvas patēriņš	6,9 mA (2,6 mA bez noslodzes)
Maks. izejas strāva	1,3 A pie 24 V līdzstrāvas (ar 20 mA interfeisu)
Maksimālais līnijas garums	1000 m (1093,6 jardi)
Drošības klase	II, saskaņā ar IEC 60950 / EN 60950
EMI / EMC aizsardzība	EN 50081-1 / FCC Part 15
Aizsardzības klase	IP 30, saskaņā ar IEC 60529
Darba temperatūra	-5 °C ... 50 °C (23 °F ... 122 °F)
Uzglabāšanas temperatūra	-20 °C ... 60 °C (23 °F ... 140 °F)
Pieļaujamais relatīvais mitrums	maks. 95%, nekondensējošs
Apvalka materiāls un krāsa	ABS plastmasa Polylac PA-766 (UL94 V-0), daļēji glancēts antracīts, RAL 7016
Izmēri (A x P x D)	aptuveni 127 x 96 x 60 mm (5,0 x 3,8 x 2,4 collas)
Svars	aptuveni 175 g (6,2 unces)

Funksjonsbeskrivelse

- Kommunikasjonsmodulen på 20 mA har et S1-grensesnitt, et RS232-grensesnitt og et 20 mA-grensesnitt (strømsløyfe) der DR 2020-loggskriveren kan kobles til.

Kabling

Pos.	Markering	Tilkobling
1	S1 IN	S1-grensesnitt
2	S1 OUT	
3	TX -	20 mA-grensesnitt
4	TX +	
5	RX +	
6	RX -	
7	AUX -	+24 V / maks. 1,3 A strømforsyning
8	AUX +	
20	RXD	RS232-grensesnitt
21	TXD	
22	GND	

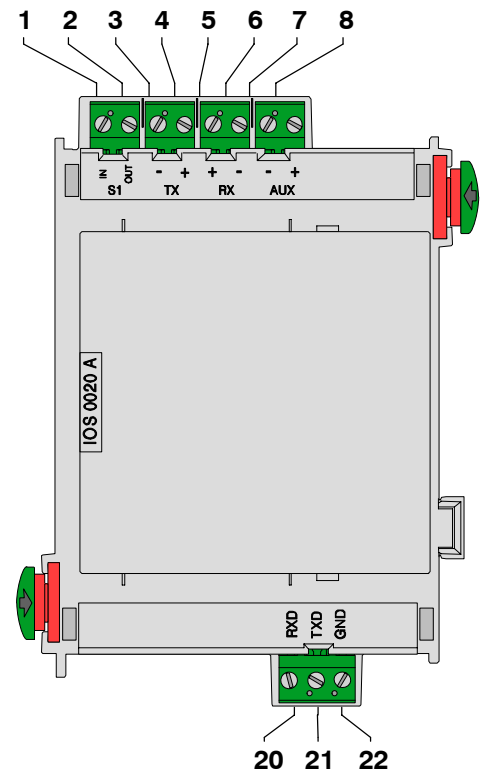

Pinnetildeling på DSUB 9-pinners plugg

Pinnennummer	Tilkobling
2	TxD0
3	RxD0
5	GND

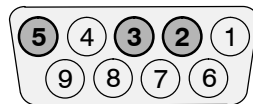

Tekniske spesifikasjoner

Inngangsspenning (min. - maks.)	20 - 30 V DC
Maks. strømforbruk	6,9 mA (2,6 mA uten belastning)
Maks. utgangsstrøm	1,3 A ved 24 V DC (på 20 mA-grensesnittet)
Maksimal ledningslengde	1000 m (1093,6 yard)
Sikkerhetsklasse	II i henhold til IEC 60950 / EN 60950
EMI- / EMC-beskyttelse	EN 50081-1 / FCC del 15
Beskyttelsesklasse	IP 30 i henhold til IEC 60529
Driftstemperatur:	-5 °C ... 50 °C (23 °F ... 122 °F)
Lagringstemperatur	-20 °C ... 60 °C (-4 °F ... 140 °F)
Tillatt relativ fuktighet	Maks. 95 % ikke-kondenserende
Husmateriale og -farge	ABS-plast Polylac PA-766 (UL94 V-0), halvblank koksgrå, RAL 7016
Mål (H x B x D)	Ca. 127 x 96 x 60 mm (5,0 x 3,8 x 2,4 tommer)
Vekt	Ca. 175 g (6,2 unser)

Functies

- De 20 mA communicatiemodule biedt een S1-interface, een RS232-interface en een 20 mA (stroomlus)-interface voor de aansluiting van een DR 2020-logboekprinter.

Bekabeling

Pos.	Markering	Aansluiting
1	S1 IN	S1-interface
2	S1 OUT	
3	TX -	20 mA-interface
4	TX +	
5	RX +	
6	RX -	
7	AUX -	+24 V DC / max. 1,3 A voeding
8	AUX +	
20	RXD	RS232-interface
21	TXD	
22	GND	

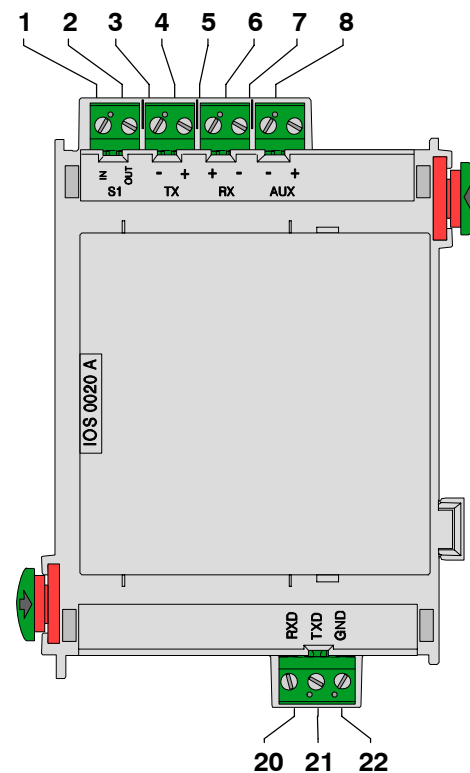

Penbezetting van 9-polige DSUB-stekker

Pennr.	Aansluiting
2	TxD0
3	RxD0
5	GND

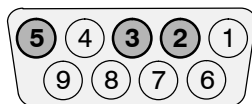

Technische specificatie

Ingangsspanning (min - max)	20 V DC - 30 V DC
Max. stroomverbruik	6,9 mA (2,6 mA onbelast)
Max. uitgangsstroom	1,3 A bij 24 V DC (op de 20 mA-interface)
Maximale kabellengte	1000 m
Veiligheidsklasse	II volgens IEC 60950 / EN 60950
EMI/EMC-beveiliging	EN 50081-1 / FCC deel 15
Beschermingsklasse	IP 30 volgens IEC 60529
Bedrijfstemperatuur	-5 °C . . . 50 °C
Opslagtemperatuur	-20 °C . . . 60 °C
Toegestane relatieve vochtigheid	max. 95% niet-condenserend
Materiaal en kleur van de behuizing	ABS-kunststof Polyac PA-766 (UL94 V-0), halfglans antraciet, RAL 7016
Afmetingen (H x B x D)	ca. 127 x 96 x 60 mm
Gewicht	ca. 175 g

Descrição funcional

- O módulo de comunicação de 20 mA fornece uma interface S1, uma interface RS232 e uma interface 20 mA (anel de corrente) para estabelecer ligação à impressora de registo DR 2020.

Ligações eléctricas

Pos.	Marcação	Ligação
1	S1 IN	Interface S1
2	S1 OUT	
3	TX -	Interface 20 mA
4	TX +	
5	RX +	
6	RX -	
7	AUX -	Fonte de alimentação de +24 V CC / máx 1,3 A
8	AUX +	
20	RXD	Interface RS232
21	TXD	
22	GND	

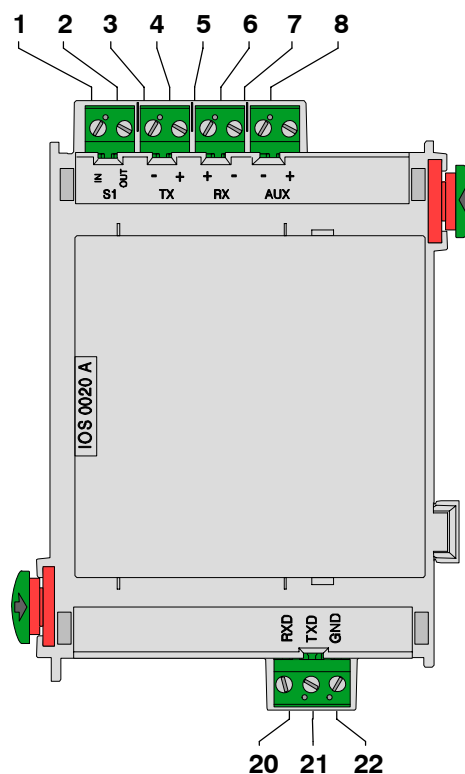

Atribuição de pinos da ficha DSUB 9

N.º do pino	Ligação
2	TxD0
3	RxD0
5	GND

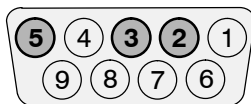

Especificações técnicas

Tensão de entrada (mín - máx)	20 V CC - 30 V CC
Consumo de corrente máx.	6,9 mA (2,6 mA sem carga)
Corrente de saída máx.	1,3 A a 24 V CC (na interface 20 mA)
Comprimento máximo da linha	1000 m
Classe de segurança	II em conformidade com a norma IEC 60950 / EN 60950
Protecção EMI / EMC	EN 50081-1 / FCC Parte 15
Classe de protecção	IP 30 em conformidade com a norma IEC 60529
Temperatura de funcionamento	-5 °C ... 50 °C (23 °F ... 122 °F)
Temperatura de armazenamento	-20 °C ... 60 °C (-4 °F ... 140 °F)
Humidade relativa permitida	máx. 95% sem condensação
Material e cor da caixa	Plástico ABS Polylac PA-766 (UL94 V-0), antracite semibrilhante, RAL 7016
Dimensões (A x L x P)	aprox. 127 x 96 x 60 mm (5,0 x 3,8 x 2,4 polegadas)
Peso	aprox. 175 g (6,2 onças)

Opis działania

- Moduł komunikacyjny 20 mA został wyposażony w interfejs S1, interfejs RS232 oraz interfejs 20 mA (pętla prądowa) umożliwiające podłączenie drukarki raportów DR 2020.

Gniazda połączeniowe

Pozycja	Oznaczenie	Połączenie
1	S1 IN	Interfejs S1
2	S1 OUT	
3	TX -	Interfejs 20 mA
4	TX +	
5	RX +	
6	RX -	
7	AUX -	Zasilacz +24 VDC / maks. 1,3 A
8	AUX +	
20	RXD	Interfejs RS232
21	TXD	
22	GND	

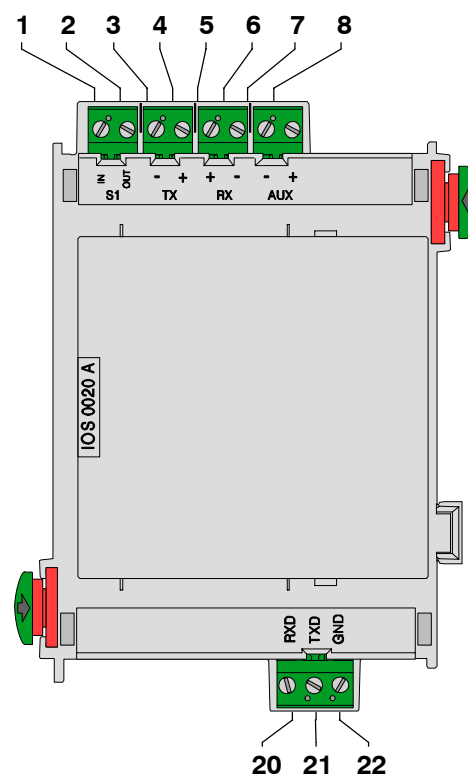

Przyporządkowanie styków złącza 9-stykowego Sub-D

Nr styku	Połączenie
2	TxD0
3	RxD0
5	GND

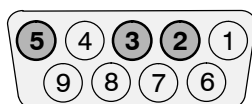

Dane techniczne

Napięcie wejściowe (min. - maks.)	20 VDC - 30 VDC
Maksymalny pobór prądu	6,9 mA (2,6 mA bez obciążenia)
Maksymalny prąd wyjściowy	1,3 A przy napięciu 24 VDC (interfejs 20 mA)
Maksymalna długość linii	1000 m
Klasa bezpieczeństwa	II zgodnie z IEC 60950 / EN 60950
Ochrona przed zakłóceniami EMI / EMC	EN 50081-1 / FCC, Część 15
Klasa ochrony	IP 30 zgodnie z IEC 60529
Temperatura pracy	-5 °C ... 50 °C
Temperatura przechowywania	-20 °C ... 60 °C
Dopuszczalna wilgotność względna	maks. 95% bez kondensacji
Materiał i kolor obudowy	tworzywo ABS Polylac PA-766 (UL94 V-0) antracyt, półpołysk, RAL 7016
Wymiary (wys. x szer. x gł.)	ok. 127 x 96 x 60 mm
Masa	ok. 175 g

Descriere funcțională

- Modulul de comunicare de 20 mA oferă o interfață S1, o interfață RS232 și o interfață de 20 mA (buclă de curent) pentru conectarea imprimantei de jurnalizare DR 2020.

Cablare

Nr.	Nume	Conexiune
1	S1 IN	Interfață S1
2	S1 OUT	
3	TX -	Interfață 20 mA
4	TX +	
5	RX +	
6	RX -	
7	AUX -	alimentare +24 V CC / max. 1,3 A
8	AUX +	
20	RXD	Interfață RS232
21	TXD	
22	GND	

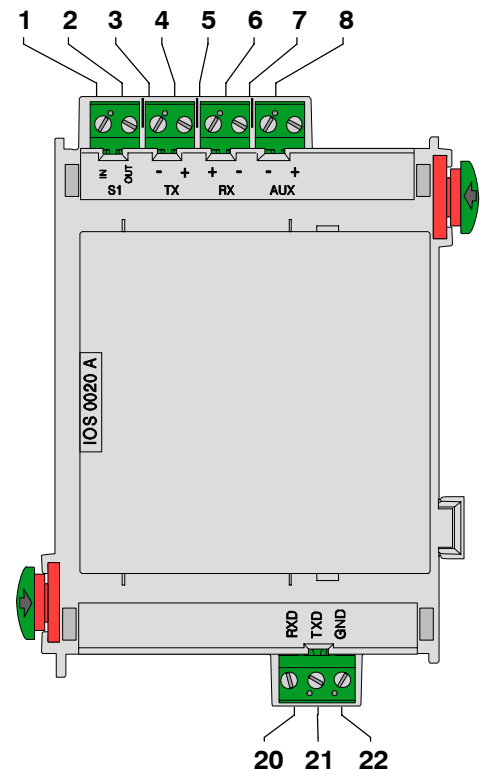

Repartizarea pinilor conectorului DSUB cu 9 pini

Nr. pin	Conexiune
2	TxD0
3	RxD0
5	GND

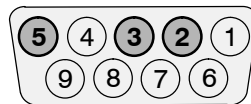

Specificații tehnice

Tensiune de intrare (min - max)	20 V CC - 30 V CC
Consum electric maxim	6,9 mA (2,6 mA fără sarcină)
Curent maxim de ieșire	1,3 A la 24 V CC (la interfața de 20 mA)
Lungime maximă a liniei	1000 m (1093,6 yarzi)
Clasă de siguranță	II cf. IEC 60950 / EN 60950
Protecție EMI / EMC	EN 50081-1 / FCC Part 15
Clasă de protecție	IP 30 cf. IEC 60529
Temperatură de funcționare	-5 °C ... 50 °C (23 °F ... 122 °F)
Temperatură de stocare	-20 °C ... 60 °C (-4 °F ... 140 °F)
Umiditate relativă permisă	max. 95% fără condensare
Material și culoare carcasă	Plastic ABS Polylac PA-766 (UL94 V-0), antracit semi-lucios, RAL 7016
Dimensiuni (H x l x A)	aprox. 127 x 96 x 60 mm (5,0 x 3,8 x 2,4 in.)
Greutate	aprox. 175 g (6,2 oz.)

Описание принципа действия

- Коммуникационный модуль 20 мА обеспечивает интерфейс S1, интерфейс RS232 и интерфейс 20 мА (токовая петля) для подключения регистрационного принтера DR 2020.

Подключения

Поз.	Маркировка	Соединение
1	S1 IN	Интерфейс S1
2	S1 OUT	
3	TX -	Интерфейс 20 мА
4	TX +	
5	RX +	
6	RX -	
7	AUX -	+24 В пост. тока / макс. 1,3 А питание
8	AUX +	
20	RXD	Интерфейс RS232
21	TXD	
22	GND	

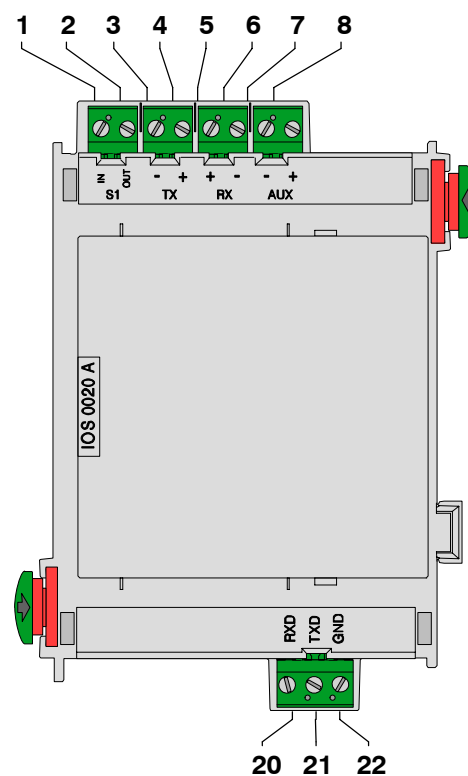

Разводка выводов 9-контактного разъема DSUB

PIN-№.	Соединение
2	TxD0
3	RxD0
5	GND

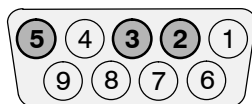

Техническое описание

Напряжение на входе (мин - макс)	20 В пост. тока - 30 В пост. тока
Макс. потребление тока	6,9 мА (2,6 мА без электроприемника)
Макс. ток на выходе	1,3 А при 24 В пост. тока (интерфейс 20 мА)
Максимальная длина линии	1000 м (1093,6 ярда)
Класс безопасности	II по IEC 60950 / EN 60950
Защита от электромагнитных помех / электромагнитной совместимости	EN 50081-1 / FCC часть 15
Класс защиты	IP 30 по IEC 60529
Рабочая температура	-5 °C ... 50 °C (23 °F ... 122 °F)
Температура хранения	-20 °C ... 60 °C (-4 °F ... 140 °F)
Допустимая относительная влажность	макс. 95% без конденсата
Материал и цвет корпуса	Пластмасса ABS Polyloc PA-766 (UL94 V-0), полуматовый антрацит, RAL 7016
Размеры (В x Ш x Г)	приблиз. 127 x 96 x 60 мм (5,0 x 3,8 x 2,4 дюйма)
Вес	приблиз. 175 г (6,2 унции)

Funktionsbeskrivning

- Den 20 mA kommunikationsmodulen har ett S1-gränssnitt, ett RS232-gränssnitt och en 20 mA (strömslinga) utgång som kan användas till att ansluta DR 2020 loggskrivaren.

Anslutningar

Pos.	Märkning	Anslutning
1	S1 IN	S1-gränssnitt
2	S1 OUT	
3	TX -	20 mA utgång
4	TX +	
5	RX +	
6	RX -	
7	AUX -	+24 V likström / max. 1,3 A strömförsörjning
8	AUX +	
20	RXD	RS232-gränssnitt
21	TXD	
22	GND	

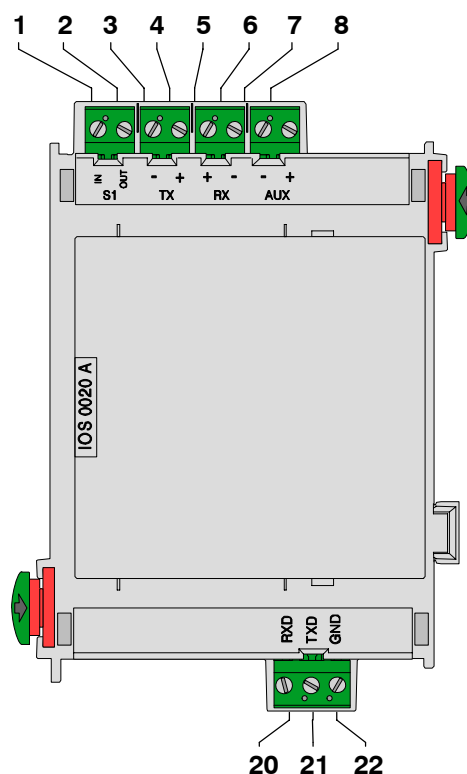

Stifttilldelning för DSUB 9-stiftskontakt

Stift nr.	Anslutning
2	TxD0
3	RxD0
5	GND

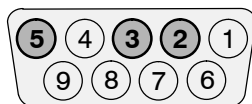

Tekniska specifikationer

Inspänning (min - max)	20 V till 30 V likström
Max. strömförbrukning	6,9 mA (2,6 mA utan belastning)
Max. utgående ström	1,3 A vid 24 V likström (vid 20 mA-utgången)
Maximal ledningslängd	1000 m
Säkerhetsklass	II enligt IEC 60950 / EN 60950
EMI / EMC-skydd	EN 50081-1 / FCC del 15
Skyddsklass	IP 30 enligt IEC 60529
Driftstemperatur	-5 °C till 50 °C
Förvaringstemperatur	-20 °C till 60 °C
Tillåten relativ luftfuktighet	max. 95 % ickekondenserande
Inkapslingsmaterial och -färg	ABS-plast Polylac PA-766 (UL94 V-0), halvglättad antracit, RAL 7016
Mått (H x B x D)	ca 127 x 96 x 60 mm
Vikt	ca 175 g

Opis funkcija

- Komunikacijski modul 20 mA sadrži S1 interfejs, RS232 interfejs i 20 mA (zatvoreni strujni krug) interfejs za spajanje DR 2020 štampača zapisnika.

Ožičenje

Pol.	Oznaka	Priključak
1	S1 IN	S1 interfejs
2	S1 OUT	
3	TX -	20 mA interfejs
4	TX +	
5	RX +	
6	RX -	
7	AUX -	+24 V DC / maks. 1,3 A napajanje
8	AUX +	
20	RXD	RS232 interfejs
21	TXD	
22	GND	

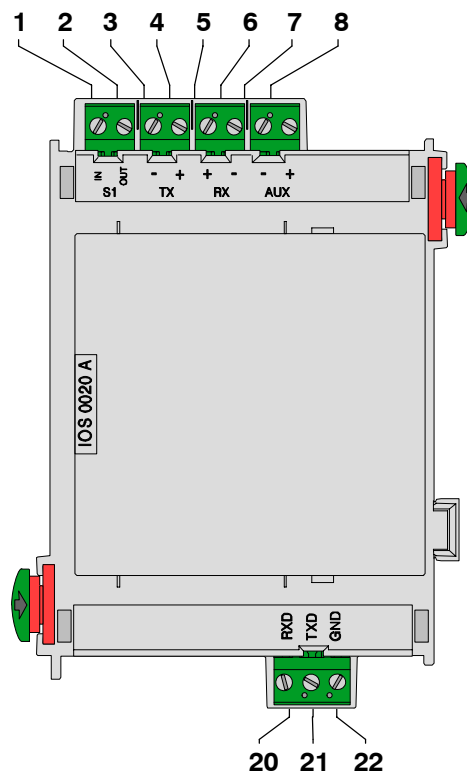

Dodela pina za DSUB 9 priključak za pin

Broj PIN-a	Priključak
2	TxD0
3	RxD0
5	GND

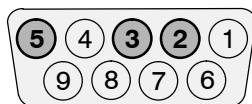

Tehničke specifikacije

Ulazni napon (min - maks)	20 V DC - 30 V DC
Maks. potrošnja električne energije	6,9 mA (2,6 mA bez opterećenja)
Maks. izlazna električna energija	1,3 A pri 24 V DC (kod interfejsa od 20 mA)
Maksimalna dužina voda	1000 m (1093,6 jarda)
Klasa bezbednosti	II po IEC 60950 / EN 60950
EMI / EMC zaštita	EN 50081-1 / FCC deo 15
Zaštitna klasa	IP 30 po IEC 60529
Radna temperatura	-5 °C ... 50 °C (23 °F ... 122 °F)
Temperatura za skladištenje	-20 °C ... 60 °C (-4 °F ... 140 °F)
Dozvoljena relativna vlažnost	maks. 95% bez kondenzacije
Materijal i boja kućišta	ABS plastika Polylac PA-766 (UL94 V-0), polusjajni antracit, RAL 7016
Dimenzije (V x Š x D)	oko 127 x 96 x 60 mm (5,0 x 3,8 x 2,4 inča)
Težina	oko 175 g (6,2 unci)

Funkcionalni opis

- 20 mA komunikacijski modul ima vmesnik S1, vmesnik RS232 in 20 mA vmesnik (zančni tok) za priključitev tiskalnika dnevnika DR 2020.

Električna povezava

Pol.	Oznaka	Povezava
1	S1 IN	S1 vmesnik
2	S1 OUT	
3	TX -	20 mA vmesnik
4	TX +	
5	RX +	
6	RX -	
7	AUX -	+24 V DC / maks. 1,3 A napajanje
8	AUX +	
20	RXD	RS232 vmesnik
21	TXD	
22	GND	

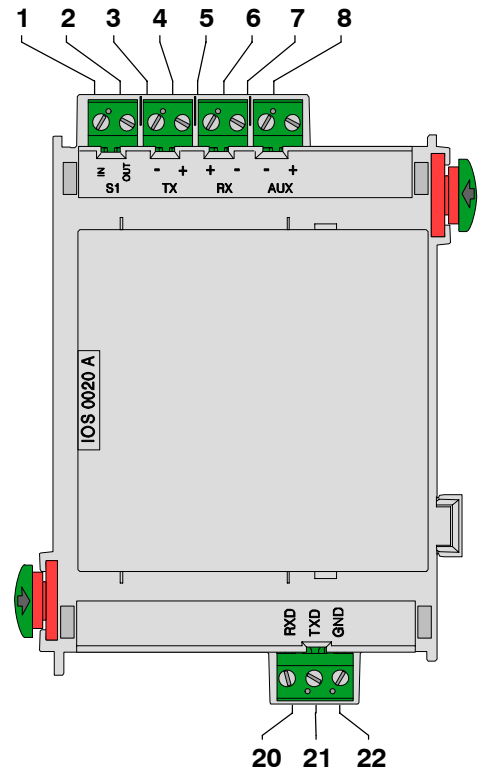

Dodelitev pinov 9-pinskega vtiča DSUB

Št. PIN	Povezava
2	TxD0
3	RxD0
5	GND

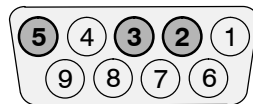

Tehnične specifikacije

Vhodna napetost (min. - maks.)	20 V DC - 30 V DC
Maks. poraba toka	6,9 mA (2,6 mA brez obremenitve)
Maks. izhodni tok	1,3 A pri 24 V DC (pri 20 mA vmesniku)
Maksimalna dolina voda	1000 m
Varnostni razred	II po standardu IEC 60950 / EN 60950
Zaščita EMI / EMC	EN 50081-1 / FCC del 15
Razred zaščite	IP 30 po standardu IEC 60529
Delovna temperatura	-5 °C ... 50 °C (23 °F ... 122 °F)
Hrambna temperatura	-20 °C ... 60 °C (-4 °F ... 140 °F)
Dovoljena relativna vlaga	maks. 95 % brez kondenza
Material in barva ohišja	ABS plastika poliuretanski lak PA-766 (UL94 V-0), polsijajni antracitni, RAL 7016
Dimenzije (V x Š x G)	pribl. 127 x 96 x 60 mm
Masa	pribl. 175 g

Fonksiyonel açıklamalar

- DR 2020 kayıt yazıcısını bağlamak için 20 mA iletişim modülü bir S1 arabirimi, bir RS232 arabirimi ve bir 20 mA (akım devresi) arabirimi sağlamaktadır.

Kablo bağlantısı

Konum.	İşaret	Bağlantı
1	S1 IN	S1 Arabirimi
2	S1 OUT	
3	TX -	20 mA Arabirimi
4	TX +	
5	RX +	
6	RX -	
7	AUX -	+24 V DC / maks. 1,3 A güç kaynağı
8	AUX +	
20	RXD	RS232 Arabirimi
21	TXD	
22	GND	

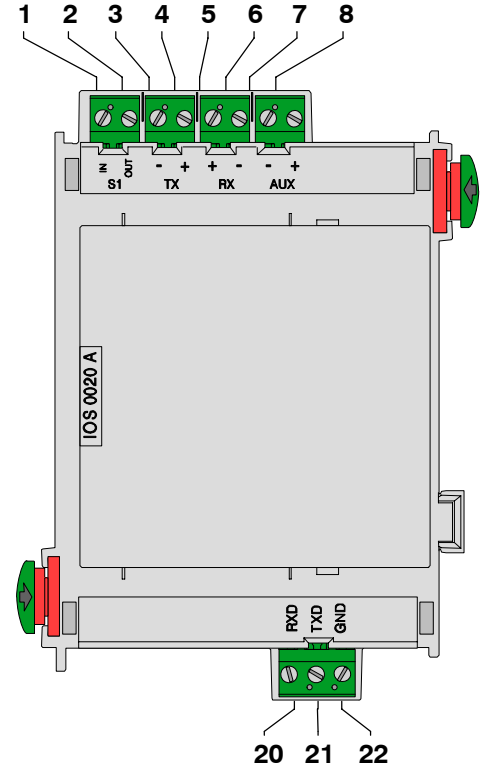

DSUB 9 pimli soketin pim ataması

PIN No.	Bağlantı
2	TxD0
3	RxD0
5	GND

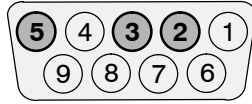

Teknik Özellikler

Giriş gerilimi (min - maks)	20 V DC - 30 V DC
Maks. akım tüketimi	6,9 mA (yüksüz olarak 2,6 mA)
Maks. çıkış akımı	24 V DC'de 1,3 A (20 mA arabiriminde)
Hat maksimum uzunluğu	1000 m (1093,6 yard)
Güvenlik sınıfı	IEC 60950 / EN 60950 uyarınca II
EMI / EMC koruma	EN 50081-1 / FCC Bölüm 15
Koruma sınıfı	IEC 60529 uyarınca IP 30
Çalışma Sıcaklığı	-5 °C ... 50 °C (23 °F ... 122 °F)
Saklama Sıcaklığı	-20 °C ... 60 °C (-4 °F ... 140 °F)
İzin verilen bağıl nem	maks. %95 yoğunlaşmasız
Muhafaza malzemesi ve rengi	ABS plastik Polydac PA-766 (UL94 V-0), yarı cam antrazit, RAL 7016
Boyutlar (Y x G x D)	yaklaşık 127 x 96 x 60 mm (5 x 3,8 x 2,4 inç)
Ağırlık	yaklaşık 175 g (6,2 ons)

BOSCH

**Bosch Sicherheitssysteme GmbH
Robert-Koch-Straße 100
D-85521 Ottobrunn**

**Info-Service
www.bosch-sicherheitssysteme.de
info.service@de.bosch.com**