



KX SERIES

ALARM CONTROL UNIT

INSTALLER MANUAL



EN 50131-1
EN 50131-3
EN 50131-6
EN 50136-1
EN 50136-2
CLASS II

IMPORTANT NOTES

- The following manual has been prepared to provide assistance to users who use the system. All those who use the systems listed in this manual must be authorized.
- The information contained in this document are property of AMC Elettronica s.r.l.
- All information contained in this document is subject to change without notice.
- Every part of this manual should be interpreted and used only for the purposes for which it was drafted, the use other than as prescribed must be authorized by AMC Elettronica srl, under penalty of forfeiture of the guarantee.
- All trademarks, symbols and examples contained in this manual belong to their respective owners.

GUARANTEE

AMC Electronics s.r.l. ensures that products are free from defects in workmanship.

The product is not installed by the manufacturer and can be used with other products not manufactured by AMC Elettronica srl, the manufacturer does not guarantee or be held responsible for damage and / or theft or other types of issues caused by an incorrect installation and / or configuration of the system.

Is not guaranteed to:

- improper use of the panel
- programming errors
- manipulation and vandalism
- wear and tear
- lightning, floods, fire.

AMC Electronics s.r.l. reserves the right to repair or replace the defective product within the limits established for 24 months.

A different use from that stated in this manual will void the warranty.

The installation must be performed in a workmanlike manner by qualified personnel.

COMPLIANCE

AMC Electronics s.r.l. declares that the X and K series alarm control unit are provisions of Directive 1999/5 /CE
On our web site www.amcelettronica.com

STANDARDS:

All products mentioned in this manual are in accordance with the rules:

EN 50131-1 + EN 50131-3 + EN 50131-6 (control and indicating equipment for alarm system)

EN 50136-1 + EN 50136-2 (GSM and PSTN alarm transmission)

Certifier: IMQ – Sistemi di sicurezza Grade: 2 Class:2

Following is the list of normed products:

K4P: control unit (plastic box)

K8P: control unit (plastic box)

K8plusP: control unit (plastic box)

X412P: control unit (plastic box)

X824P: control unit (plastic box)

X864P: control unit (plastic box)

K4M: control unit (plastic box)

K8M: control unit (plastic box)

K8plusM: control unit (Metal box)

X412M: control unit (Metal box)

X824M: control unit (Metal box)

X864M: control unit (Metal box)

PSTN carrier ATS type B on board K4 e K8 (ATS2: D2-M2-T2-S0-I0)*

KLCD: keypad

KLight: keypad

KLight plus: keypad with 2 in/out terminal

KXIN: inputs expansion

KXOUT: outputs

Transformer 25VA

Transformer 30VA

Xgprs/gsm: gsm - gprs module

IP1: IP module

* D2:transmission time 60sec. M2:max transmission time 120sec. T2:time of control information transmission 25h
- S0:no bearing replacement I0: no protection of the information.

MANUFACTURER



AMC Elettronica s.r.l.
Via Pascoli 359
22040 Alzate Brianza
Como
Italy
Tel. +39031632780
Fax +39031632781
Info@amcelettronica.com
www.amcelettronica.com

CONTENT OF THE PLASTIC & METAL BOX

In the carton box there is:

- Metal or plastic box with inside:
 - Panel board
 - Transformer
 - Earth cable
 - housing fuse
 - Balancing resistors (8 of 1K - 8 of 2K2)
 - plastic bag with screws and plastic turrets for fix all parts and close the box
 - Adesive data label
 - user manual

The packaging does not contain:

- kit Tamper for antiopening and removal (mandatory for EN approval)
- Installation Manual
- backup battery
- programming Software **InstallDBExplorer**
- fisher for fix on the wall the plastic box

The material not included in the box can be purchased except:

the programming software and Installation manual can be downloaded from our site: www.amcelettronica.com

INTRODUCTION

X an K series are security control panel for building protection with certification*

EN 50131-1 + EN 50131-3 + EN 50131-6 (control and indicating equipment for alarm system) +

EN 50136-1 + EN 50136-2 2013 (LAN - GPRS - GSM and PSTN alarm transmission)

Certifier **IMQ – Sistemi di sicurezza.**

The control panel are equipped of 4/8 zones, expandable to 16/32/64 with remote modules.

It is possible to obtain more zones by double and triple EOL split line, this configuration is not certified to EN 50131

ALARM COMUNICATION

X K series are able to notify one or more situations of ALARM, ROBBERY, TAMPERING AN TROUBLE with different carriers:

- PSTN LINE ON BOARD **type ATS3/SP3 refered to EN 50136-2:2013 ****
- GSM/GPRS optional module **type ATS3/SP3 refered to EN 50136-2:2013 ****
- IP module optional **type ATS3/SP3 refered to EN 50136-2:2013 ****

The programming can be via local keypad or a PC with specific software.

** after specific programming and by enable the automatic EN configurator in panel (see description below)*

*** to ensure the classification SP3 the periodic test call must be programmed for work every 30' minutes, or for have classification SP2, the periodic test call can be programmed for work every 25h.*

See the table with option below

NOTIFICATION EQUIPMENT DESCRIPTION AND CONFIGURATION

The notifications of alarm, robbery, intrusion, fault, manipulation, and other conditions must be signaled by ATS and Siren, in accordance with the requirements specified in Tables to ensure the certification EN 50131-1:2013 and the grade certified.

Option A	program 2 outs internal siren + SP2 communication device (PSTN or GSM/GPRS or LAN)
Option B	Autopowered Siren + SP2 communication device (PSTN or GSM/GPRS or LAN)
Option D	SP3 communication device (PSTN or GSM/GPRS or LAN) with life test call every 30'

LEVELS OF ACCESS

The standard EN 50131 defines the following access levels:

Level 1: access by any person (no code require)

Level 2: User Access by code. Level 2 is the access of person that will use the system like ARM/DISARM and all operation that the rules of EN 50131 approval permitted. This level allows the entry of the code level 3 (installer)

Level 3: Intsaller. This level is the person or gorup of persons that will program all function of panel according with rules of EN approval and in according with specific needs of Final user LEVEL 2. Another important function of Level 3 is teach to the user level 2 how to use the system when is already programmed.

Level 4: this is the manufactorer level, this access allow to modify the internal function of system. This level has the obligation to build and design the system following the current standards.

EVENT STORAGE SYSTEM

The system has a memory for storage all events produced from panel, the number of these events is 1000, when the system will arrive at the end of the number of events storable, will proceed to delete the old one of the 1000 registered.

All events are stored in EEPROM components, and therefore not erasable and remain always stored, also in case of absence of main power.

The delete of events can be made only by the manufacturer.

DEVICES FOR CONTROL OF THE SYSTEM

There are 2 type of device for control of panel:

Type A: Klcd and Klight

Type B: Klight plus

see the explanation in this manual

The main features are:

SPECIFICATIONS	X412	X824
zones	4 -16 wired/ double,triple EOL	8 -32 wired/ double,triple EOL
wireless zones	64 zones	64 zones
outputs	5 on board - espandible to 8 (with 1 expansion)	5 on board - espandible to 8 (with 1 expansion)
user code/tag/ remote	32 users	32 users
partitions	4	4
group	4	4
keypad	4	4
tag reader	4	4
event memory	1000	1000
phone numbers	8 for SMS + 8 for protocols	8 for SMS + 8 for protocols
carriers	PSTN on board, GSM/GPRS module, IP module	PSTN on board, GSM/GPRS module, IP module
other inputs	TAMPER line / mechanical antiopening tamper	TAMPER line / mechanical antiopening tamper
PC software	yes	yes
remote manage- ment IP - GPRS	HTML page apps (Apple - Android)	HTML page apps (Apple - Android)
timers	4 per day week	4 per day week

SPECIFICATIONS	X 864
zones	8 -64 wired/ double,triple EOL
wireless zones	64 zones
outputs	5 on board - espandible to 17 (with 4 expansion)
user code/tag/ remote	64 users
partitions	8
group	4
keypad	8
tag reader	8
event memory	1000
phone numbers	8 for SMS + 8 for protocols
carriers	PSTN on board, GSM/GPRS module, IP module
other inputs	TAMPER line / mechanical antiopening tamper
PC software	yes
remote manage- ment IP - GPRS	HTML page apps (Apple - Android)
timers	8 per day week

SPECIFICATIONS	K4	K8
zones	4 -16 wired/split/ double,triple EOL	8 -32 wired/split double,triple EOL/
wireless zones	64 zones	64 zones
outputs	2 on board - espandible to 8	2 on board - espandible to 8
user code/tag/remote	32 users	32 users
partitions	4	4
group	4	4
keypad	4	4
tag reader	4	4
event memory	1000	1000
phone numbers sms/calls	8 for SMS and private calls	8 for SMS and private calls
phone for digital protols	4 numbers with another 4 for backup	4 numbers with another 4 for backup
carriers	PSTN on board, GSM/GPRS module, IP module	PSTN on board, GSM/GPRS module, IP module
other inputs	TAMPER line / mechanical antiopening tamper	TAMPER line / mechanical antiopening tamper
PC software	yes	yes
remote management IP - GPRS	HTML page apps (Apple - Android - Win phone)	HTML page apps (Apple - Android - Win phone)
timers	4 per day week	4 per day week

SPECIFICATIONS	K8PLUS
zones	8 -64 wired/radio/split double,triple EOL
outputs	2 on board - espandible to 17 (with expansion and keypad)
user code/tag/remote	64 users
partitions	8
group	4
keypad	8
tag reader	8
event memory	1000
phone numbers SMS and private call	8 numbers
phone numbers digital protocols	4 numbers with another 4 for backup
carriers	PSTN on board, GSM/GPRS module, IP module
other inputs	TAMPER line / mechanical antiopening tamper
PC software	yes
remote management IP - GPRS	HTML page apps (Apple - Android)
timers	4 per day week

METAL BOX SPECIFICATION

ELECTRIC SPECIFICATIONS	X412M	X824M	X864M
power supply	230 VAC -15% + 10% 50Hz		
protection fuse	F500mAL 250V		
out voltage	13.8 V		
Voltage range	9 - 16 V		
Max consuption	0.1A	0.1A	0.1A
board consuption	87mA@18V ~	90mA@18V ~	90mA@18V ~
max current out	1.1A	1.5A	
Max volatge ripple	400mV		
max recharge bettery current	500mA		
back up battery	12V 7Ah		12V 17Ah
max curret on Load terminal	500mA	0.9A	
power supply type (en 50131)	type A		
Dimensions	H = 255mm - L = 300mm - P = 88mm		
weight	1.5kg		

ELECTRIC SPECIFICATIONS	K4M	K8M	K8PLUS M
power supply	230 VAC -15% + 10% 50Hz		
protection fuse	F500mAL 250V		
out voltage	13.8 V		
Voltage range	9 - 16 V		
Max consuption	0.1A	0.1A	0.1A
board consuption	87mA@18V ~	90mA@18V ~	90mA@18V ~
max current out	1.1A	1.5A	
Max volatge ripple	400mV		
max recharge bettery current	500mA		
back up battery	12V 7Ah		12V 17Ah
max curret on Load terminal	500mA	0.9A	
power supply type (en 50131)	type A		
Dimensions	H 255 - L 300 - P 88 mm		H 300 - L 400 - P 90 mm
weight	2.2kg		4.7kg

ENVIRONMENTAL CONDITIONS	K4 - K8 - K8PLUS - X412 - X828 - X864
Environmental Class	class II
Temperature	-10 °C - + 40 °C
Maximum Humidity	75% (non-condensing)

ENVIRONMENTAL CONDITIONS	KLight - KLight plus - KXIN - KXOUT - Xgprs - IP1
Environmental Class	class II
Temperature	-10 °C - + 40 °C
Maximum Humidity	75% (non-condensing)

PLASTIC BOX SPECIFICATION

ELECTRIC SPECIFICATIONS	X412P	X824P	X864P
power supply	230 VAC -15% + 10% 50Hz		
protection fuse	F500mAL 250V		
out voltage	13.8 V		
Voltage range	9 - 16 V		
Max consuption	0.1A	0.1A	0.1A
board consuption	87mA@18V ~	90mA@18V ~	90mA@18V ~
max current out	1.1A	1.1A	
Max volatge ripple	400mV		
max recharge bettery current	500mA		
back up battery	12V 7Ah		12V 17Ah
max curret on Load terminal	500mA	0.9A	
power supply type (en 50131)	type A		
Dimensions	H = 255mm - L = 300mm - P = 88mm		
weight	1.5kg		

ELECTRIC SPECIFICATIONS	K4P	K8P	K8PLUS P
power supply	230 VAC -15% + 10% 50Hz		
protection fuse	F500mAL 250V		
out voltage	13.8 V		
Voltage range	9 - 16 V		
Max consuption	0.1A	0.1A	0.1A
board consuption	87mA@18V ~	90mA@18V ~	90mA@18V ~
max current out	1.1A	1.1A	
Max volatge ripple	400mV		
max recharge bettery current	500mA		
back up battery	12V 7Ah		12V 17Ah
max curret on Load terminal	500mA	0.5A	
power supply type (en 50131)	type A		
Dimensions	H = 255mm - L = 300mm - P = 88mm		
weight	1.5kg		

ENVIRONMENTAL CONDITIONS	K4 - K8 - K8PLUS - X412 - X828 - X864
Environmental Class	class II
Temperature	-10 °C - + 40 °C
Maximum Humidity	75% (non-condensing)

ENVIRONMENTAL CONDITIONS	KLIGHT - KLIGHT plus - KXIN - KXOUT - Xgprs - IP1
Environmental Class	class II
Temperature	-10 °C - + 40 °C
Maximum Humidity	75% (non-condensing)

WALL MOUNTING PLASTIC BOX

The control panel is housed in BOX compound based on Acrylonitrile-Butadiene-Styrene (ABS).

UL94 V-0, with brominated flame retardant, without PBB / PBDE.

with dimensions: H = 255mm - L = 300mm - P = 88mm

For the installation of the panel on the wall, choose not easy accessible place to unknown person.

For the drilling of the wall, use the figure that represents the measurements of the distances of the holes of plastic box (fig below)

IMPORTANT: drill the place for install the tamper

Drill, taking care not to damage any piping in the back of the wall.

Insert for each hole, 1 fisher with diameter of 6mm

Slide the cables through provided holes

Fix the box on the wall with the right screw for fisher

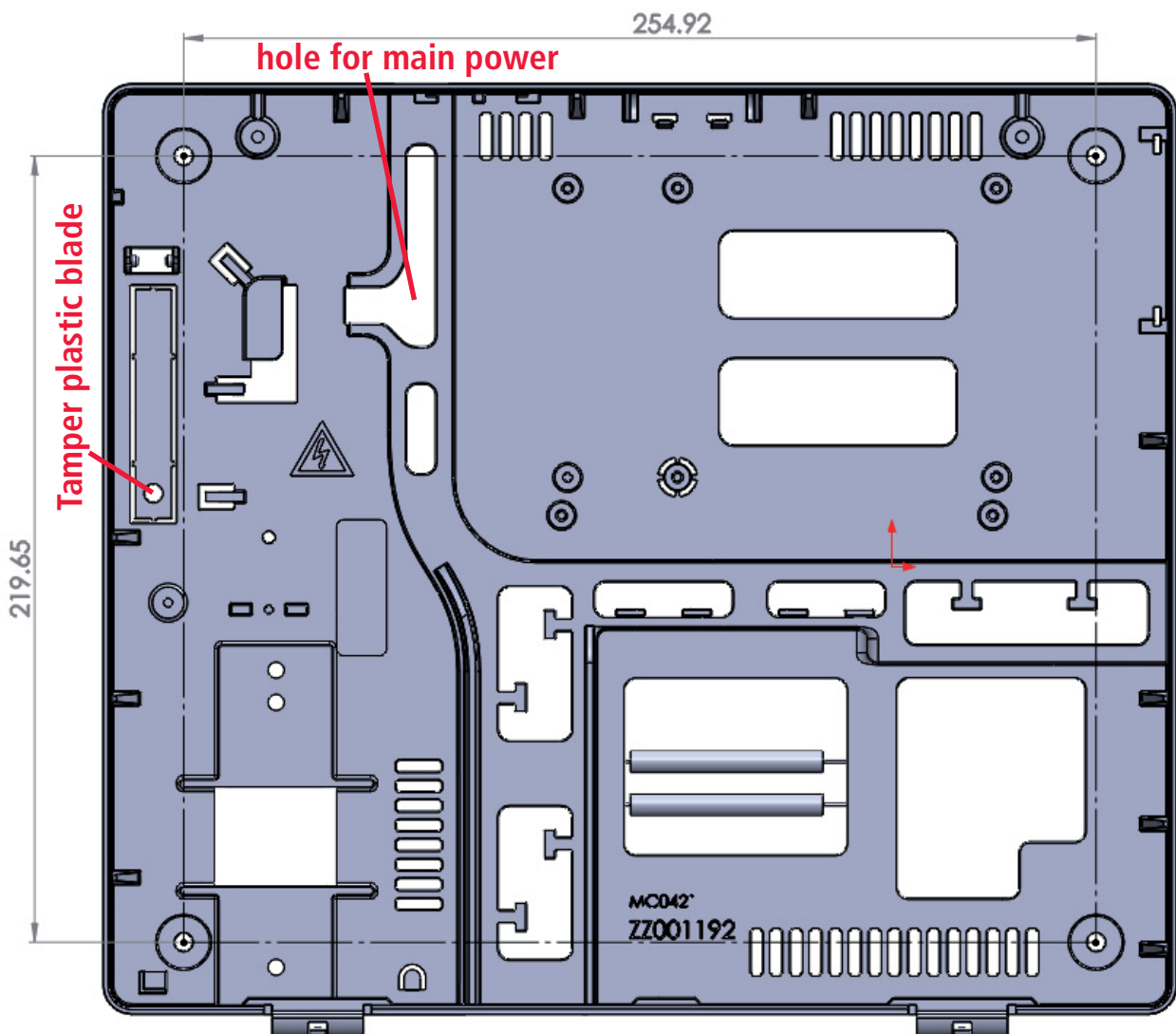

TAMPER PROTECTION

Fix the plastic blade for tamper with the right screw for 6mm fisher (see fig)

The tamper is made for protect the panel from open and remove the box.

I figure below is shown how to mounted the protection tamper:

- Fix on wall the plastic slat with a 6 mm diameter dowels (fisher) Fig.6
- Fix the tamper switch into the slot Fig.1 and Fig.2
- Connect the terminal tamper to the socket on the panel board
- Remove the plastic tower from the bottom of the box Fig.4
- Connect the tower to the socket on the cover Fig.5

In this way the system is protected from open and remove

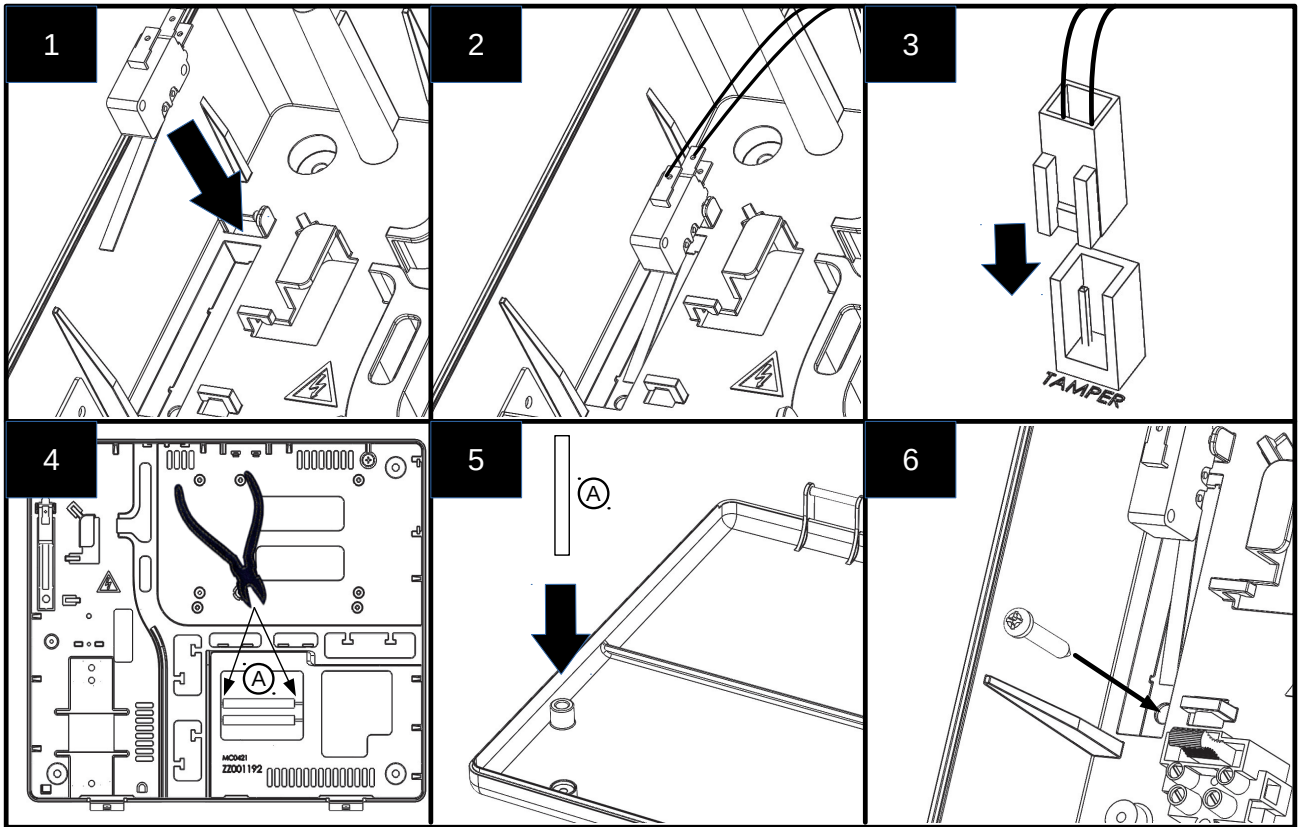

WIRING MAIN POWER AND EARTH

When the box is fixed on the wall proceed for main power cabling:

The power of the panel must be separate, and must be taken from the main power panel of the place.

The power line must be protected by devices of sectioning and protection in accordance with local regulations.

Must be connect after 16A circuit breaker device with operating curve type C, with supply conductors, (including earth), minimum section of 1.5 mm².

Wiring connection in the panel box must be like in figure below:

- Connect phase, neutral and earth to the fuse housing like in figure
- make sure that the earth connection is like the fig in next page

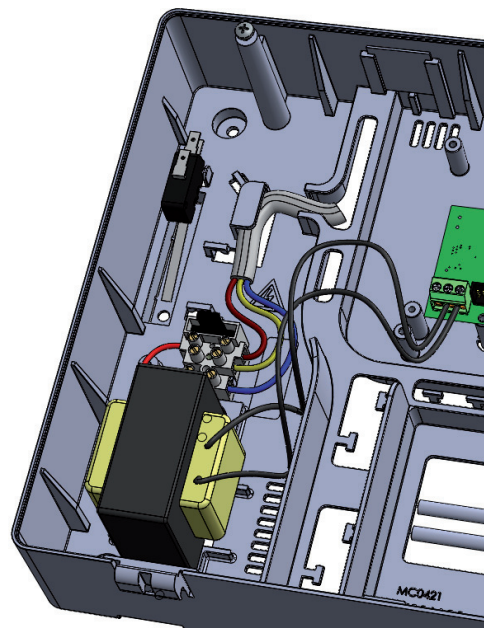
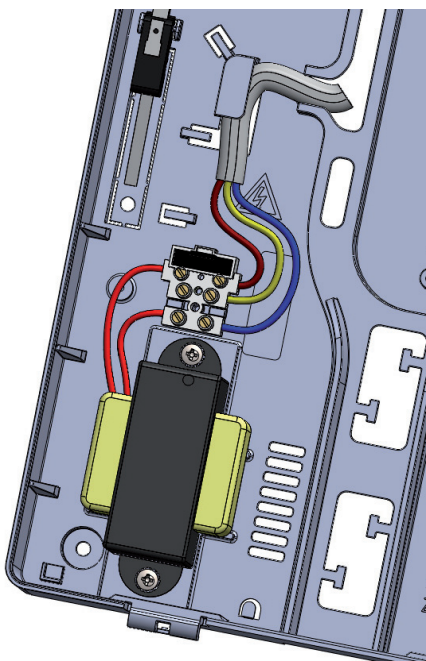

IMPORTANT: Pay max attention during the cabling
IMPORTANT: to avoid electric shock, wiring system without power

Wiring the earth like figure below:

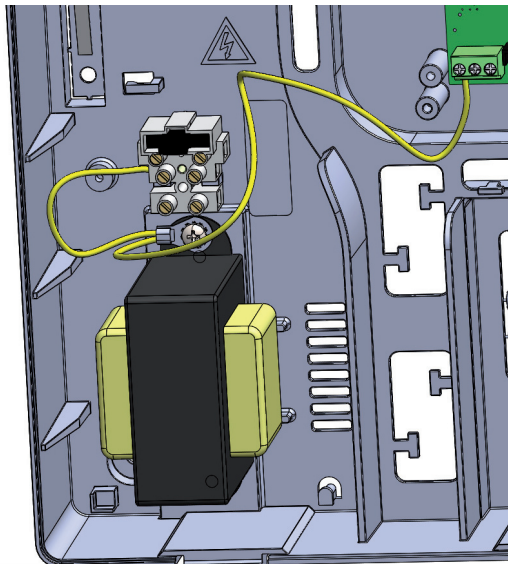

An example of wiring of the system:

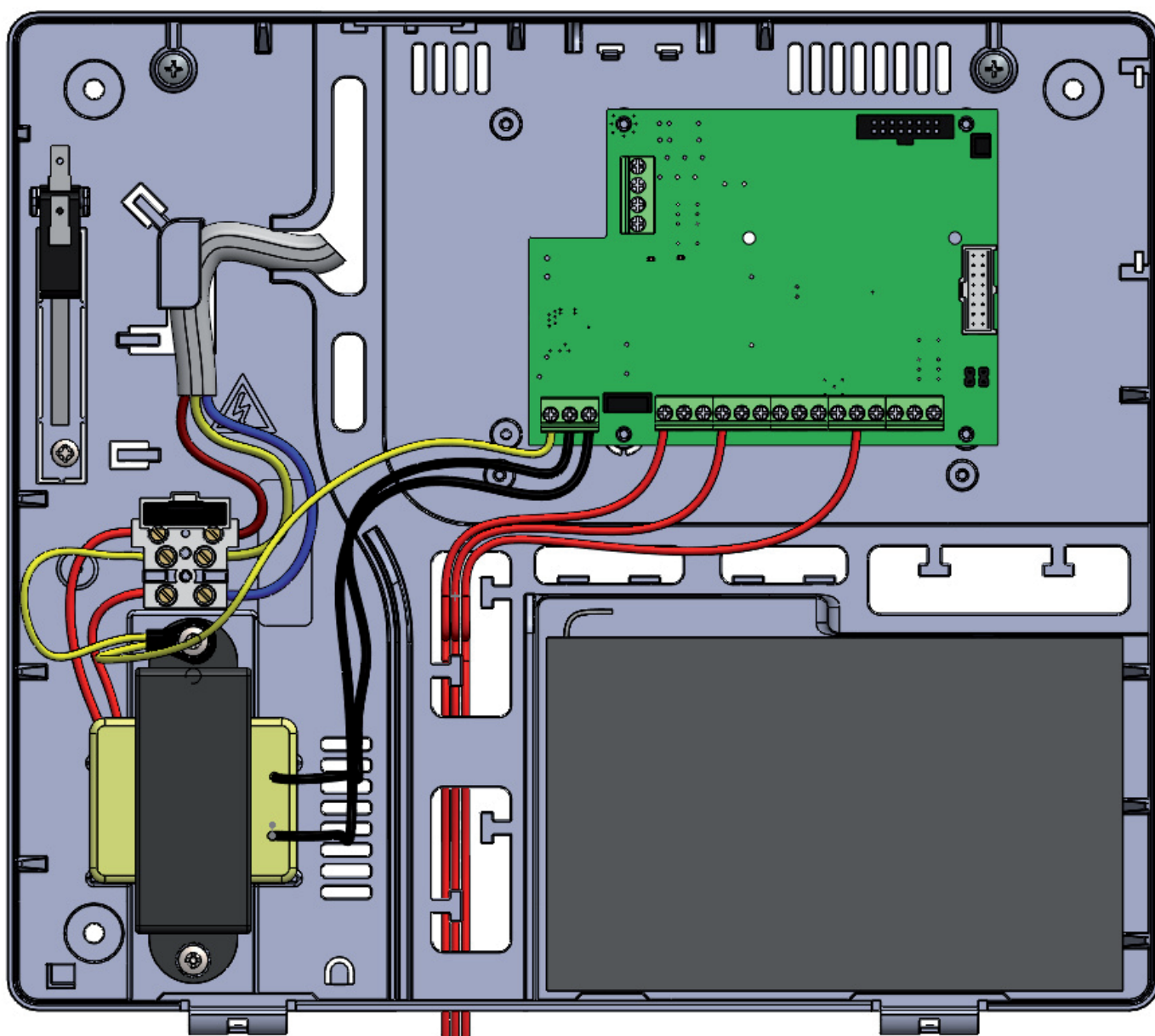

BACKUP BATTERY

The box of panel allows the housing of 7Ah Lead-acid batteries with UL94-HB flammability or higher.

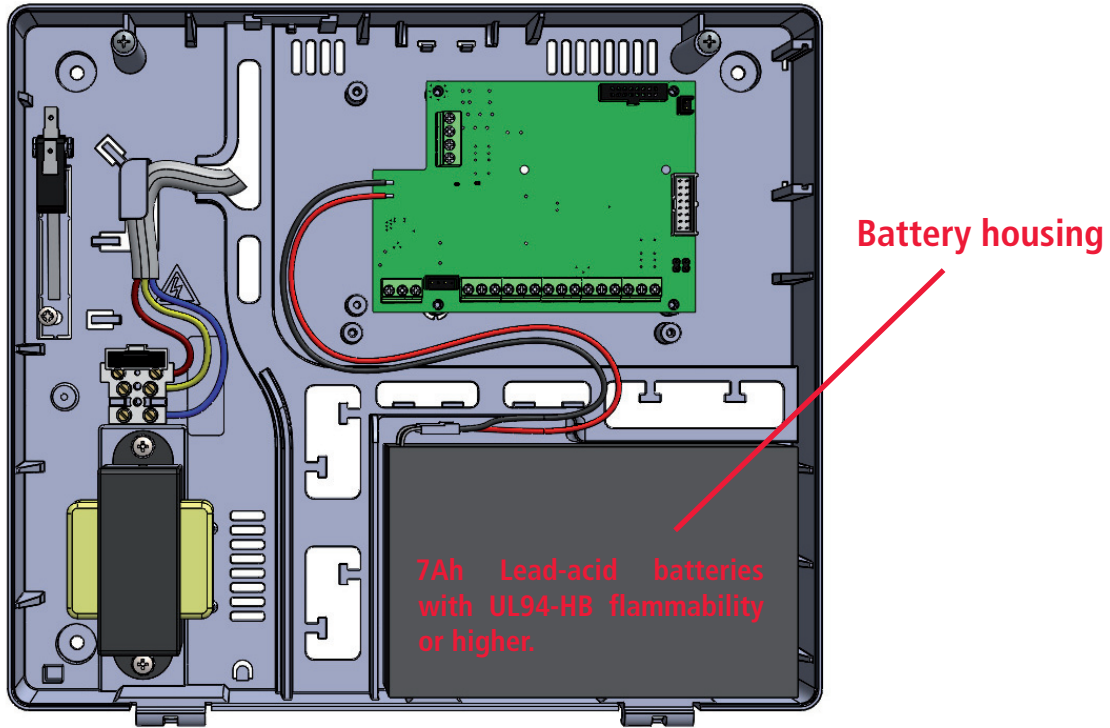

For connect the battery use the black and red terminal from panel like in figure (red: positive - black: negative)
The battery is the second source of main power of the system, and will work in case of absence of main power 230V.
The system check the status of battery every 10sec. , when the level of battery go down 10.4V the system will notify the discharge battery with a led alert in keypad. When the voltage exceeds 11.4V the system will notify the correct charge of battery.

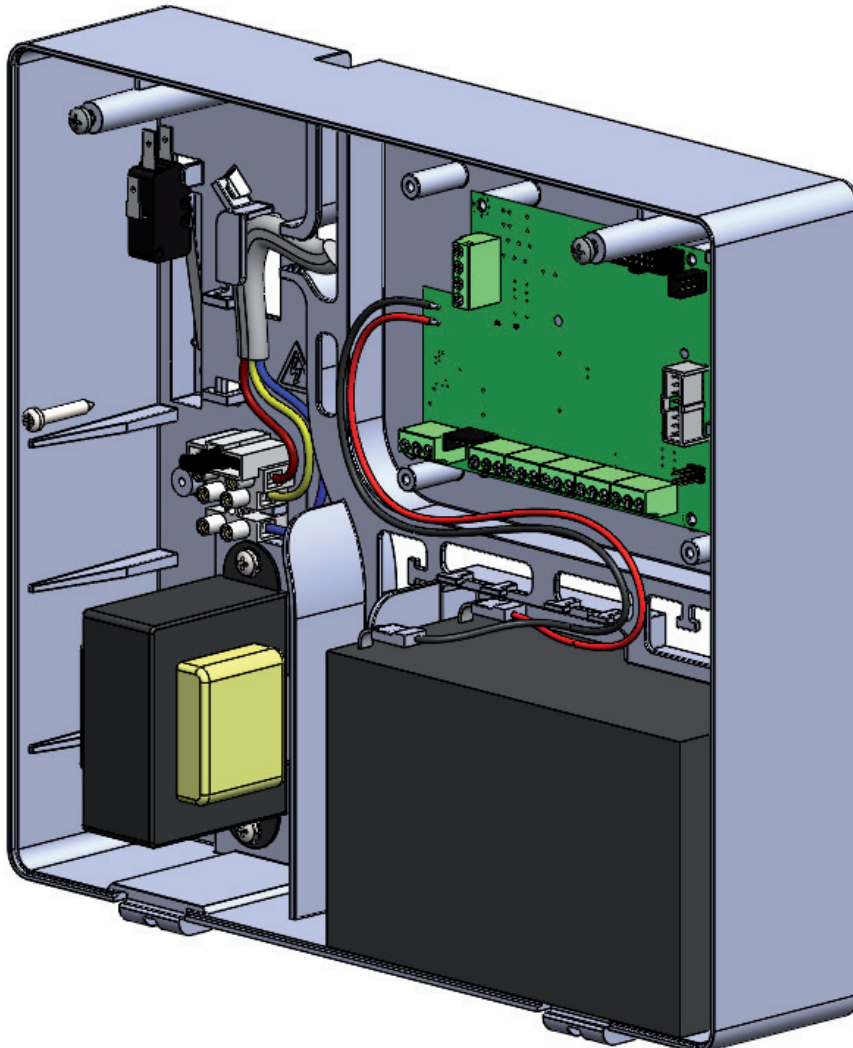

WALL MOUNTING METAL BOX

The control panel is housed in metal box with dimensions:

H = 255mm - L = 300mm - P = 88mm (battery 7Ah)

H = 300mm - L = 400mm - P = 90 mm (battery 17Ah)

For the installation of the panel on the wall, choose not easy accessible place to unknown person.

For the drilling of the wall, use the figure that represents the measurements of the distances of the holes of plastic box (fig below)

IMPORTANT: drill the place for install the tamper

Drill, taking care not to damage any piping in the back of the wall.

Insert for each hole, 1 fisher with diameter of 6mm

Slide the cables through provided holes

Fix the box on the wall with the right screw for fisher

METAL BOX FOR BATTERY 7AH

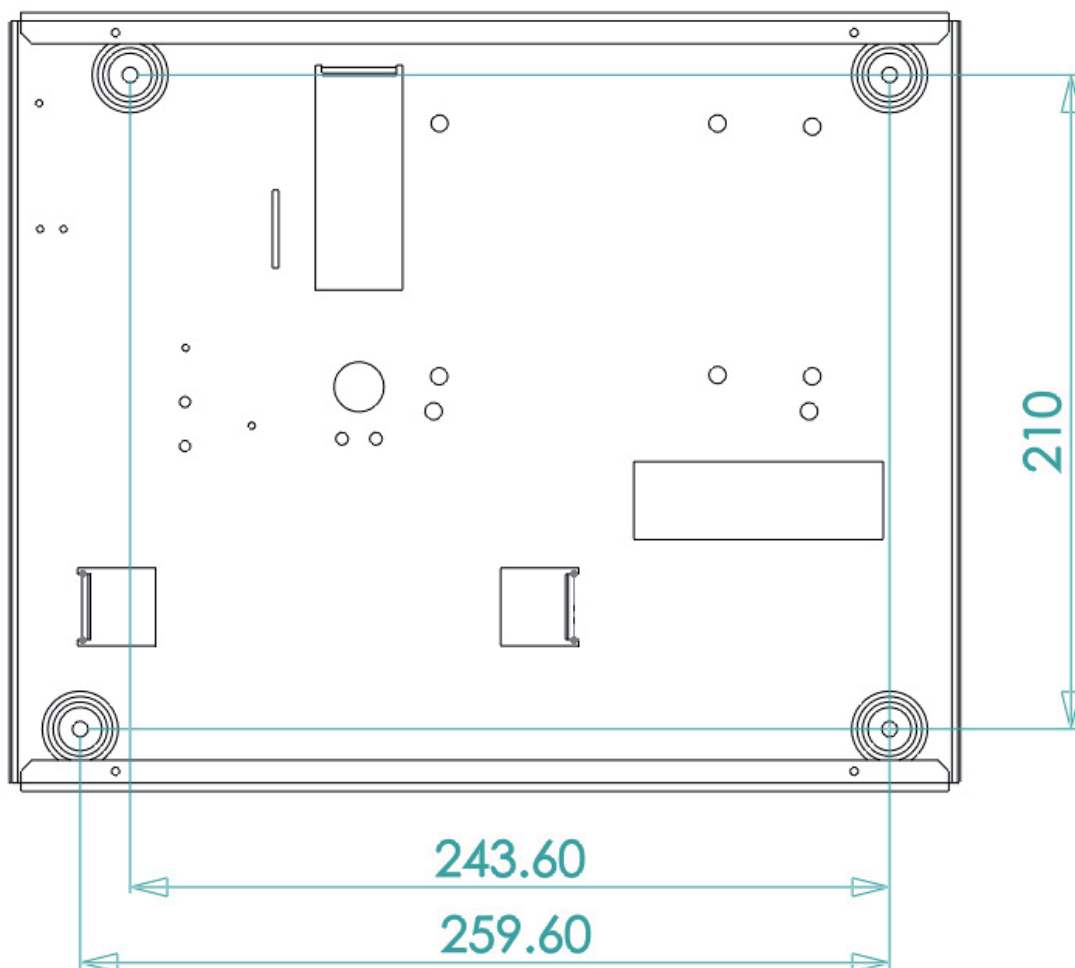

METAL BOX FOR BATTERY 17AH

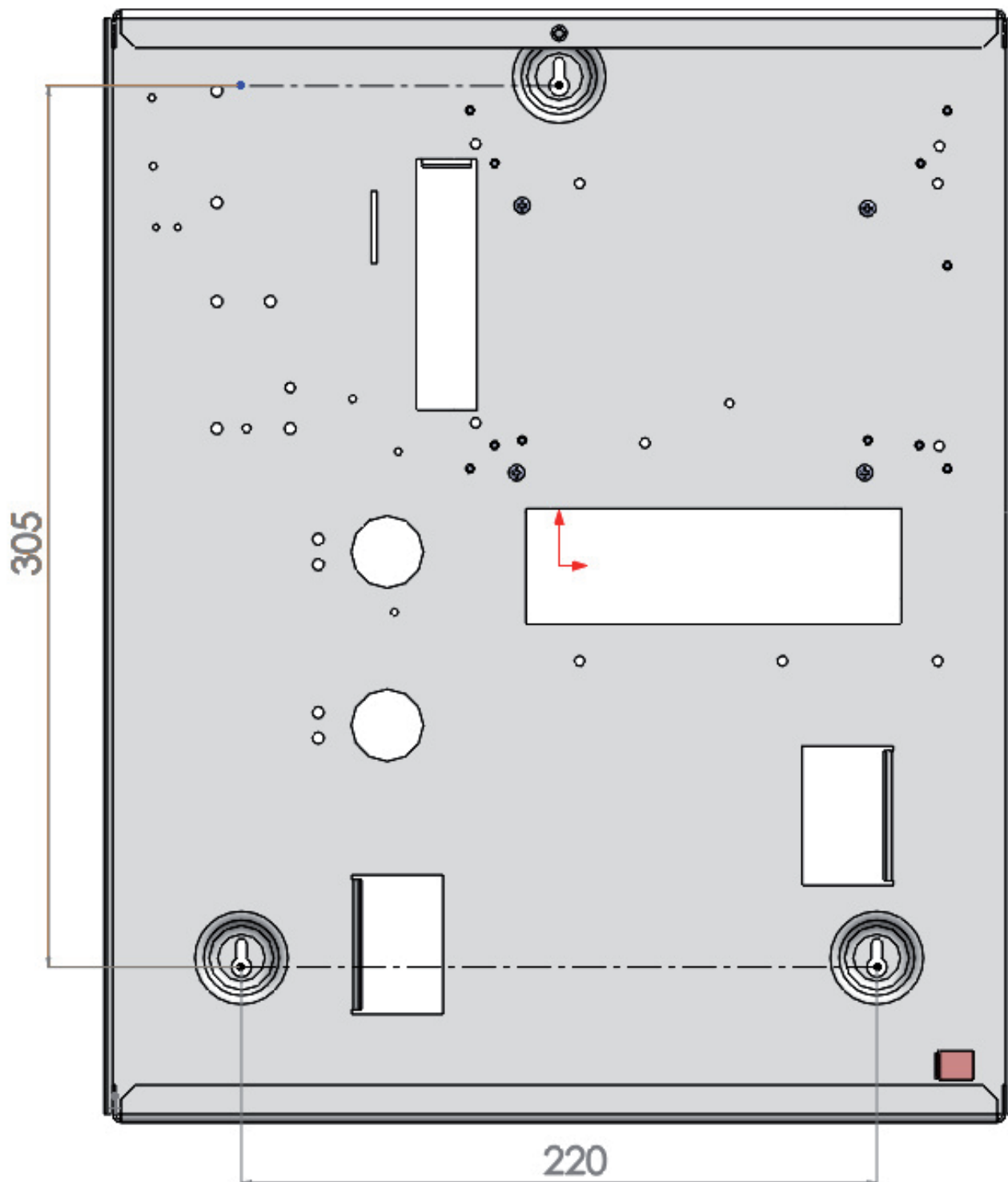

TAMPER PROTECTION

In metal box the tamper is used for opening protection.

In figure is shown how to work:

- fix the tamper switch (1) to the metal blade (2)
- Connect the terminal tamper to the socket on the panel board (3)

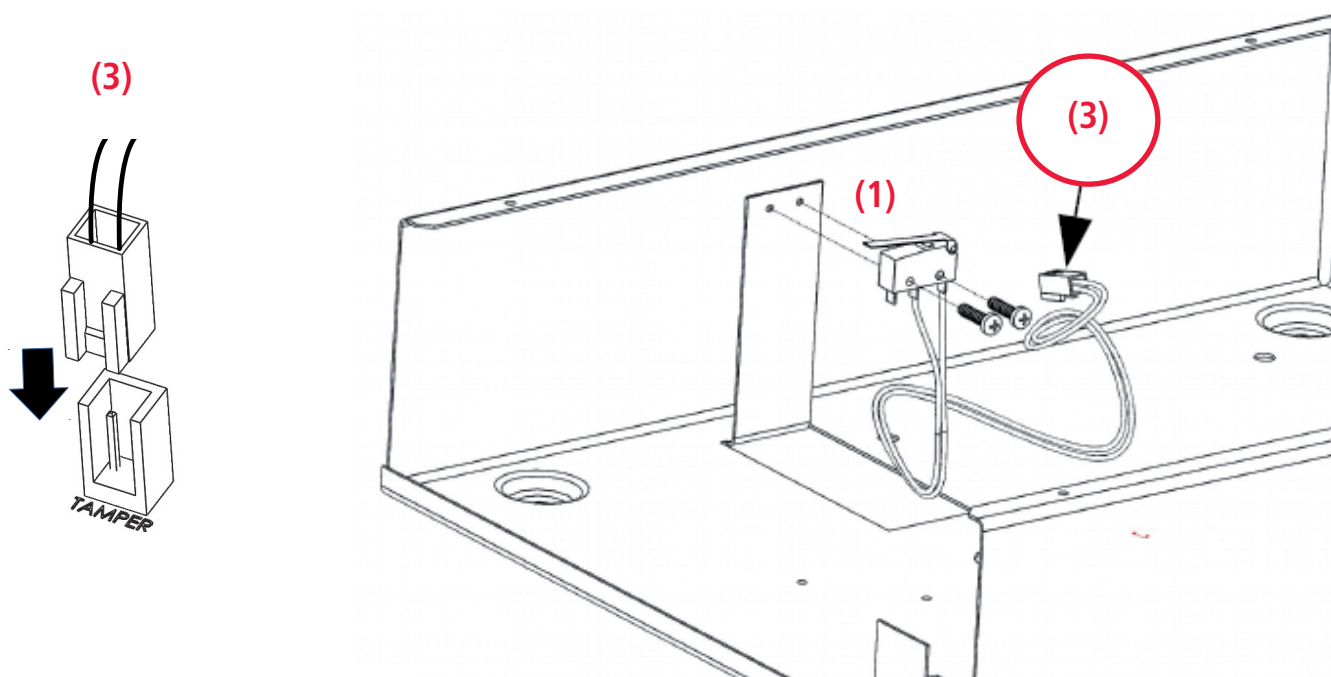
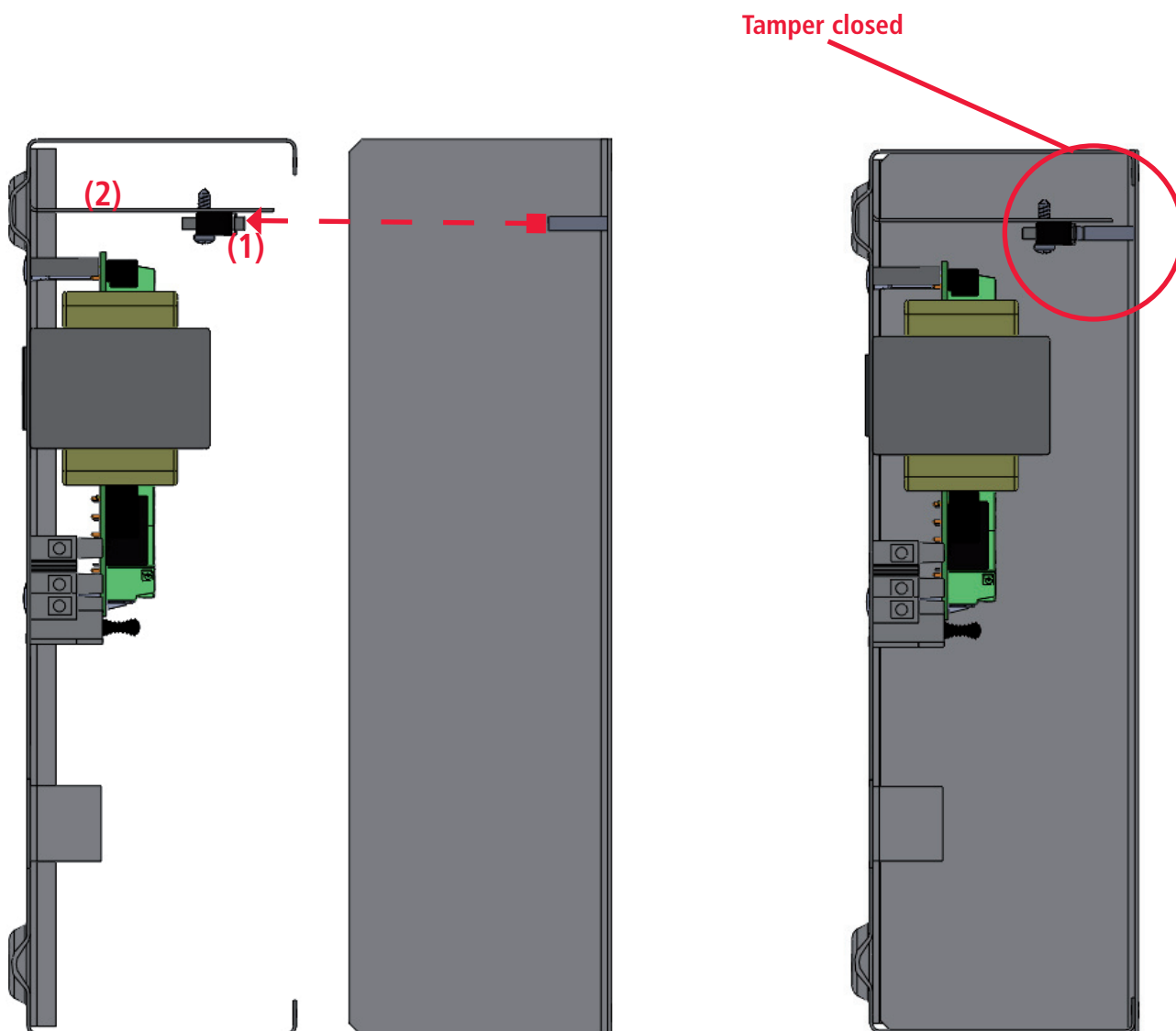

WIRING MAIN POWER AND EARTH

When the box is fixed on the wall proceed for main power cabling:

The power of the panel must be separate, and must be taken from the main power panel of the place.

The power line must be protected by devices of sectioning and protection in accordance with local regulations.

Must be connect after 16A circuit breaker device with operating curve type C, with supply conductors, (including earth), minimum section of 1.5 mm².

Wiring connection in the panel box must be like in figure below:

- Connect phase, neutral and earth to the fuse housing like in figure
- make sure that the earth connection is like the figure
- The earth is bring to the panel by metal box, the connection is made from screw of fuse housing and metallic turrets on panel

screw for connect the earth box

metal turret for bring earth to the board

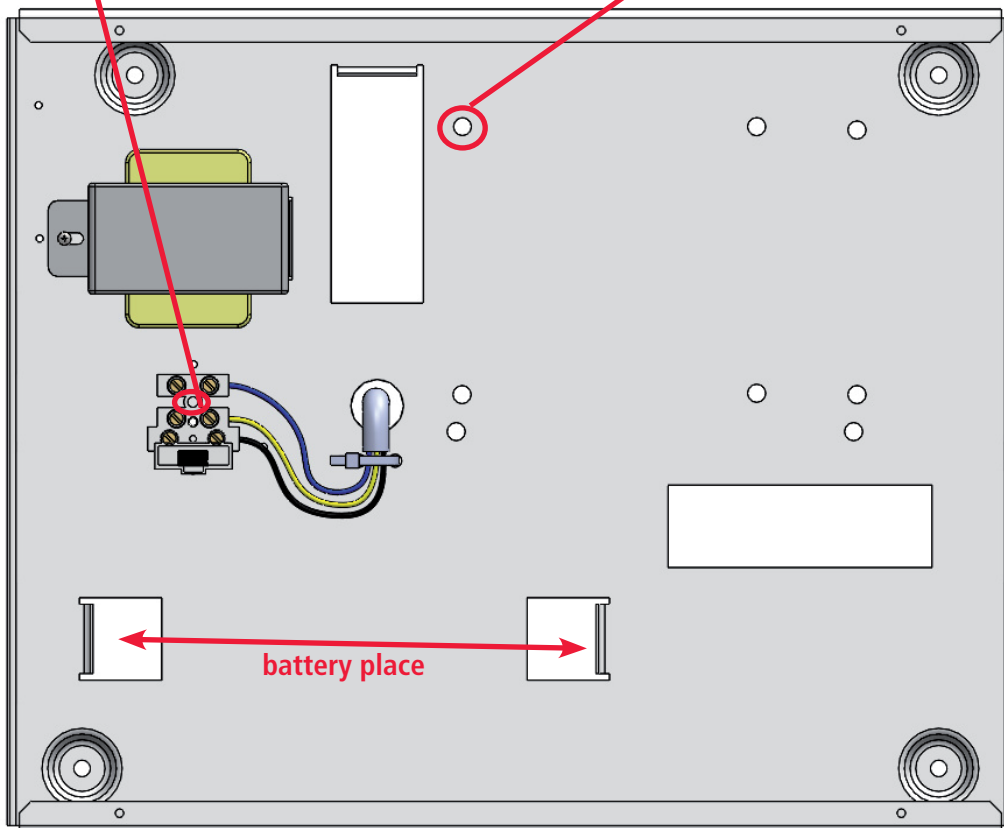

For bring the earth on closing lid of the box, use the faston terminal (see fig.)

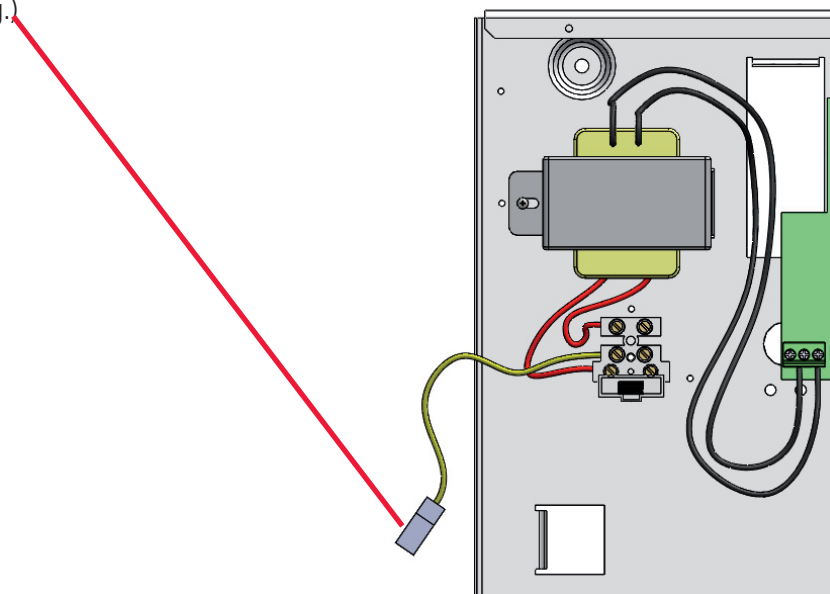

BACKUP BATTERY & WIRING VIEW

The box of panel allows the housing of 17Ah Lead-acid batteries with UL94-HB flammability or higher.

For connect the battery use the black and red terminal from panel like in figure (red: positive - black:negative)

The battery is the second source of main power of the system, and will work in case of absence of main power 230V.

The system check the status of battery every 10sec. , when the level of battery go down 10.4V the system will notify the discharge battery with a led alert in keypad. When the voltage exceeds 11.4V the system will notify the correct charge of battery.

METAL BOX FOR 17AH BATTERY VIEW

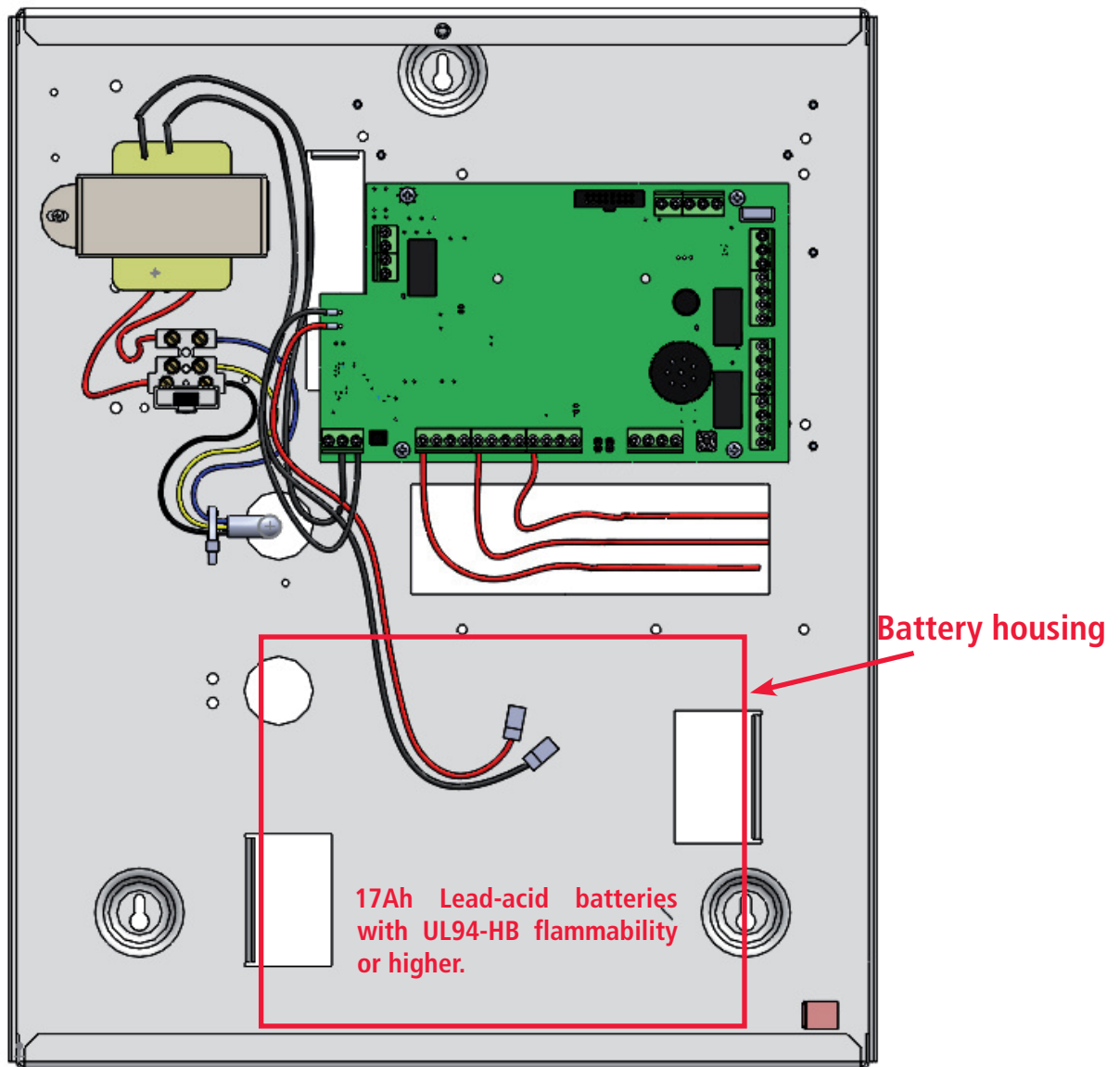

Important: attach biadhesives under the battery compartment, for fix battery and and avoid vibrations.

METAL BOX FOR 7AH BATTERY VIEW

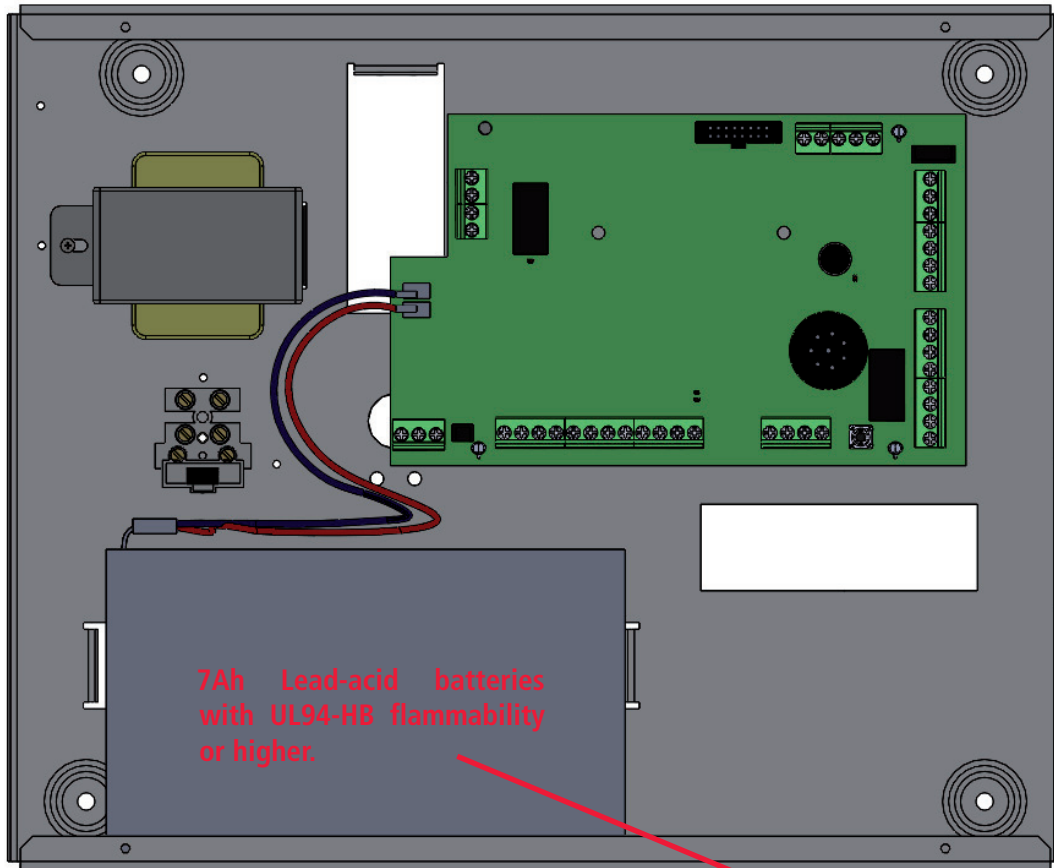

Battery housing

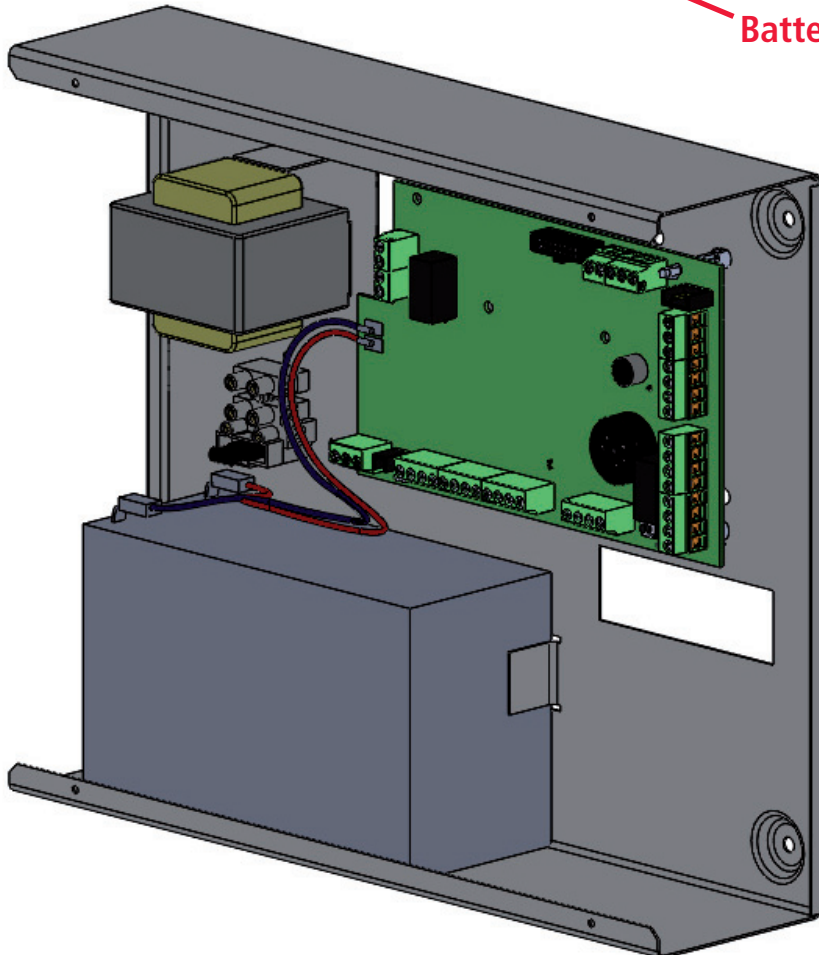

Important: attach biadhesives under the battery compartment, for fix battery and and avoid vibrations.

MAIN BOARD K4 - K8 - K8PLUS

The main board is the core of the system, all modules are be connected to it, plug the card directly or via RS-485 serial bus. The following characteristics:

BOARD DESCRIPTION

K4

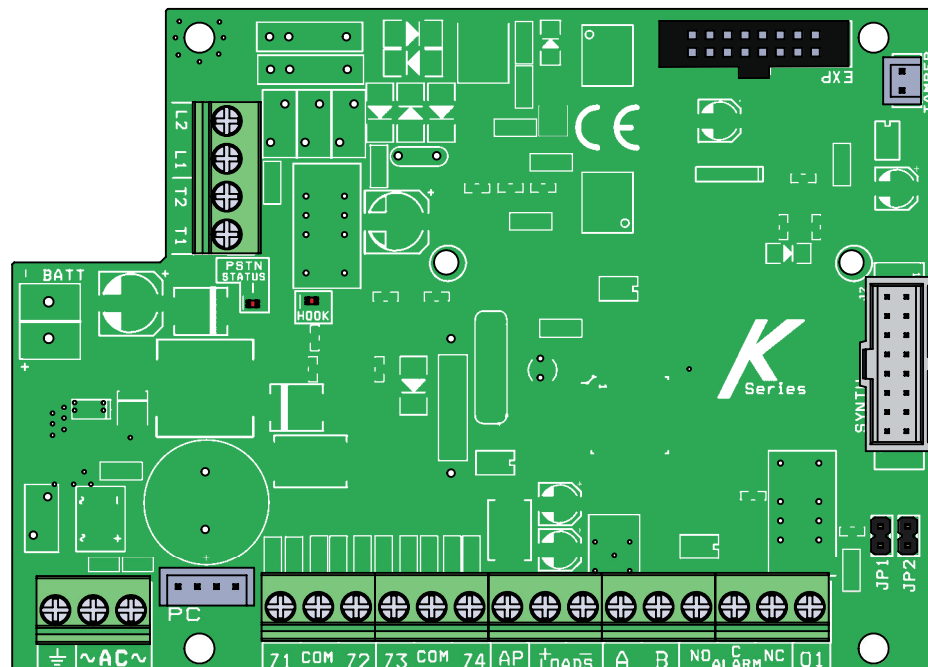

K4 TERMINALS

BATTERY + - = battery recharge terminals

L1 - L2 = AT2S phone line terminal outs (carrier out)

T1 - T2 = terminals for internal local telephones (home telephones user)

AC = main power by transformer 18Vac (available 25VA - 30VA)

Z1-Z2-Z3-Z4 = zones

COM = negative reference for zones

PC = adapter socket for programming pc software

AP = Tamper line with negative reference

LOADS (+ -) = power supply AUX 13.8 Vcc for external device (eg. sirens)

A B = (RS 485) = bus terminals for peripheral connection (see chapter fo bus connection)

ALARM (nc - no - com) = terminal for siren, free relay contact

OUT1 = PGM programmable open-collector output 100mA max current

EXP = socket for plug modules (XGSM, GPRS, IP boards)

TAMPER connector = for mechanical antiopening tamper (option)

Led on board:

HOOK LED = red color led is in ON when panel take PSTN line (PSTN HOOK on)

PSTN STATUS LED:

- STEADY YELLOW: phone line in standby stautus (no problems)

- FLASHING YELLOW : PSTN calling status

JP1 AND JP2 JUMPER ON BOARD

These jumpers must remain open

Are used for updating the firmware and total reset of the parameters. The guide for these is in the tool for upgrade FW panel.

K8 - K8PLUS

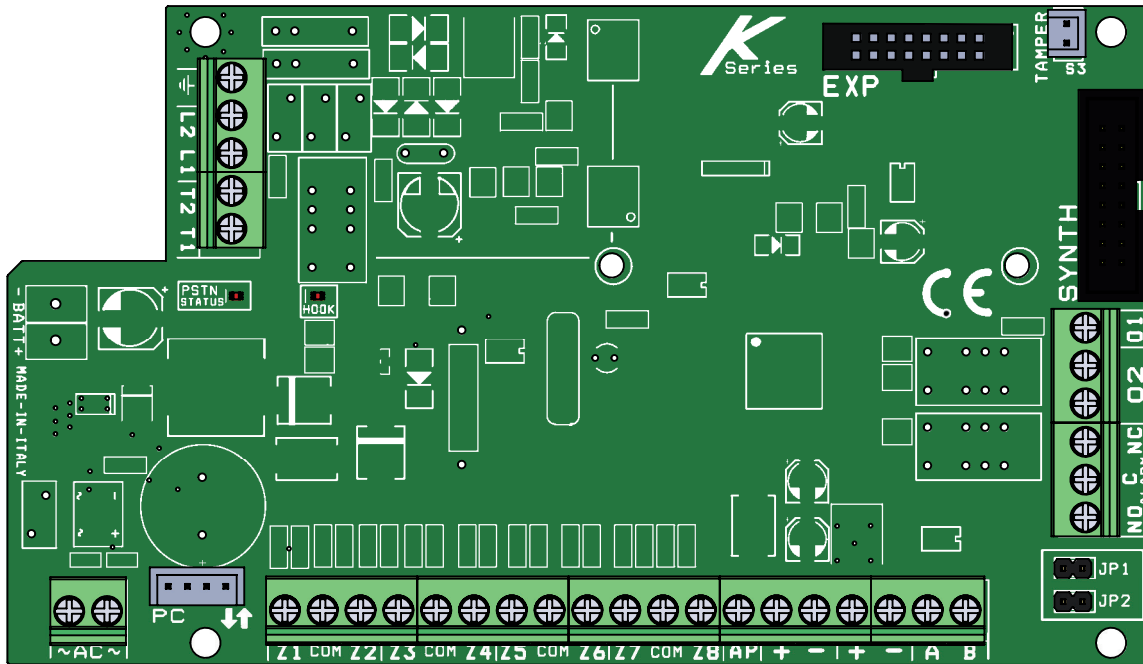

K8 - K8 PLUS TERMINALS

BATTERY + - = battery recharge terminals

L1 - L2 = AT&S2 phone line terminal outs (carrier out)

T1 - T2 = terminals for internal local telephones (home telephones user)

AC = main power by transformer 18Vac (available 25VA - 30VA)

Z1-Z2-Z3-Z4-Z5-Z6-Z7-Z8 = zones

COM = negative reference for zones

PC = adapter socket for programming pc software

AP = Tamper line with negative reference

LOADS (+ -) = power supply AUX 13.8 Vcc for external device (eg. sirens)

A B = (RS 485) = bus terminals for peripheral connection (see chapter fo bus connection)

ALARM (nc - no - com) = terminal for siren, free relay contact

OUT1 = PGM programmable open-collector output 100mA max current

OUT2 = Free conatct relay programmable output (30Vcc - 2A max)

EXP = socket for plug modules (XGSM, GPRS, IP boards)

TAMPER connector = for mechanical antiopening tamper (option)

Led on board:

HOOK LED = red color led is in ON when panel take PSTN line (PSTN HOOK on)

PSTN STATUS LED:

- STEADY YELLOW: phone line in standby stautus (no problems)

- FLASHING YELLOW : PSTN calling status

JP1 AND JP2 JUMPER ON BOARD

These jumpers must remain open

Are used for updating the firmware and total reset of the parameters. The guide for these is in the tool for upgrade FW panel.

MAIN BOARD X 412 - X 824 - 864

The main board is the core of the system, all modules are be connected to it, plug the card directly or via RS-485 serial bus.

The following characteristics:

X PANEL BOARD

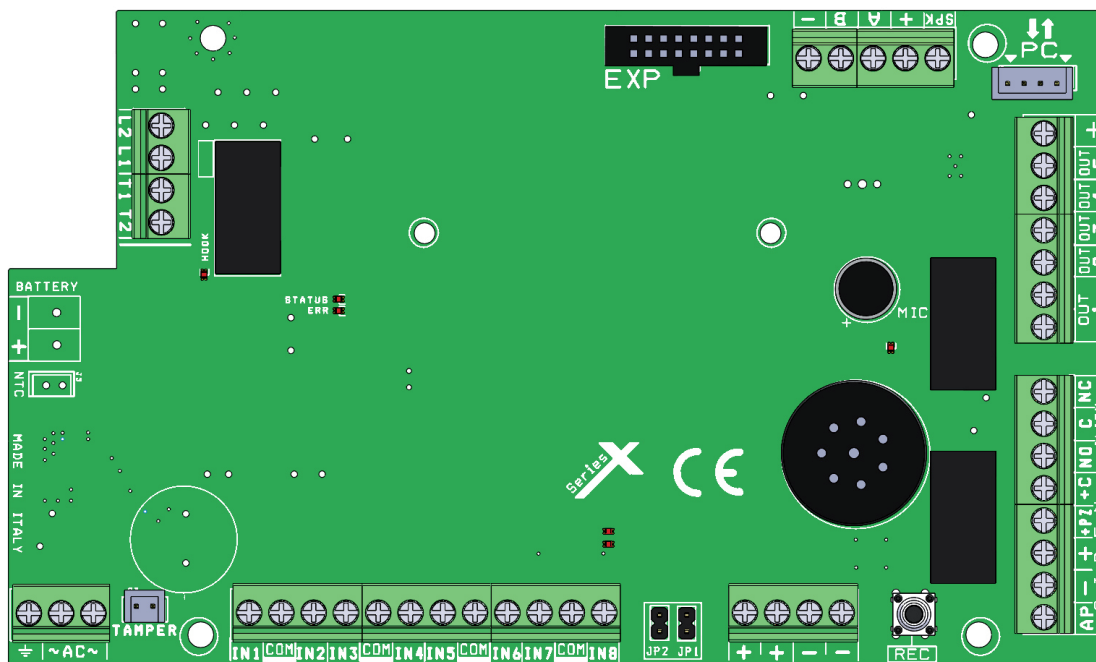

XPANELS TERMINALS

BATTERY + - = battery recharge terminals

L1 - L2 = AT52 phone line terminal outs (carrier out)

T1 - T2 = terminals for internal local telephones (home telephones user)

AC = main power by transformer 18Vac (available 25VA - 30VA)

Z1-2-3-4-5-6-7-8= zones

COM = negative reference for zones

PC = adpater socket for programming pc software

AP = Tamper line with negative reference

LOADS (+ -)= power supply AUX 13.8 Vcc for external device

+ A B - (RS 485) = bus terminals for peripheral connection (see chapter fo bus connection)

+C = terminal for siren in missing positive mode

+PZ = for lounch piezo siren, give postive mode

ALARM (nc - no - com) = terminal for siren, free relay contact

OUT1= Free conatct relay programmable output (30Vcc - 2A max)

OUT2 to 5 = PGM programmable open-collector output 100mA max current

EXP = socket for plug modules (XGSM, GPRS, IP boards)

TAMPER connector = for mechanical antiopening tamper (option)

Led on board:

HOOK red led = ON PSTN HOOK enable

STATUS yellow led phone line status:

- Steady = pstn ready in stand by
- Blink = pstn active in call
- OFF = no presence pstn line

ERR red led:

- Steady = trouble (no pstn line - no GSM - no 230Vac)
- Blink = no battery - battery low charge
- OFF = no anomalies

MIC red led = only blink during on record audio

JP1 AND JP2 JUMPER ON BOARD

These jumpers must remain open

Are used for updating the firmware and total reset of the parameters. The guide for these is in the tool for upgrade FW panel.

K LIGHT PLUS (TYPE B DEVICE)

K light plus is a Keypad that be connected to the RS485 bus. It is equipped of 2 line on board that be configured like INPUT and/or OUTPUT. K light plus is used for programming and ARM/DISARM panel, is protected from open and removing from wall. For fix the Keypad on the wall, use fisher of 4mm. For removing protection fix 1 fisher in the specific hole (see fig.) Close the shape of keypad with the screw contained in the package (see fig.)

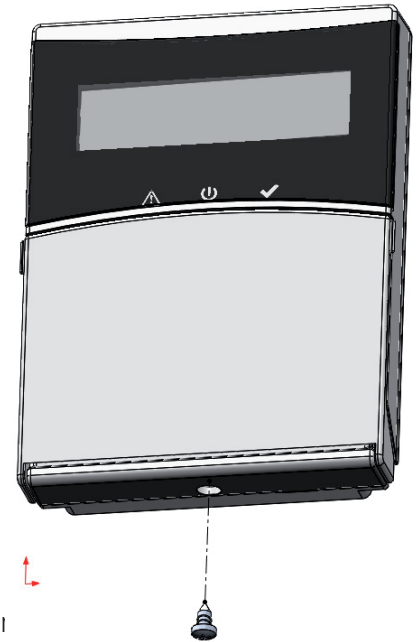
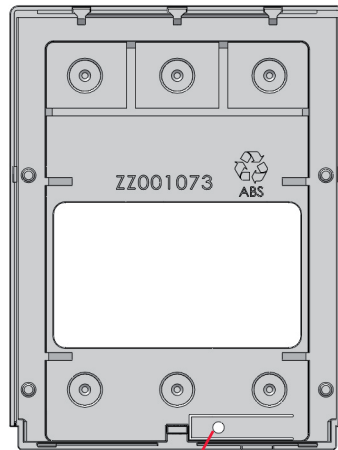
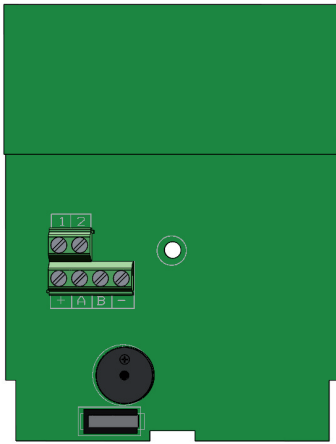

Power supply voltage: 13.8Vdc
 Rated current: 25mA
 Maximum current: 160mA

tamper hole

+ A B - (RS 485) = bus terminals for peripheral connection (see chapter fo bus connection)
 terminal 1 - 2 = terminals that be programmed like input and/or output

K LIGHT (TYPE A DEVICE)

K light is used for programming and ARM/DISARM panel, is protected from open and removing from wall. For fix the Keypad on the wall, use fisher of 4mm. For removing protection fix 1 fisher in the specific hole (see fig.) Close the shape of keypad with the screw contained in the package (see fig.) K Light has no input / output terminals.

K LCD (TYPE A DEVICE)

K LCD is a Keypad that be connected to the RS485 bus. K LCD is used for programming and ARM/DISARM panel, is protected from open and removing from wall.

For fix the Keypad on the wall, use fisher of 4mm. For removing protection fix 1 fisher in the specific hole (see fig.)

K LCD is equipped with 4 terminal:

+ A B - (RS 485) = bus terminals for peripheral connection (see chapter fo bus connection)

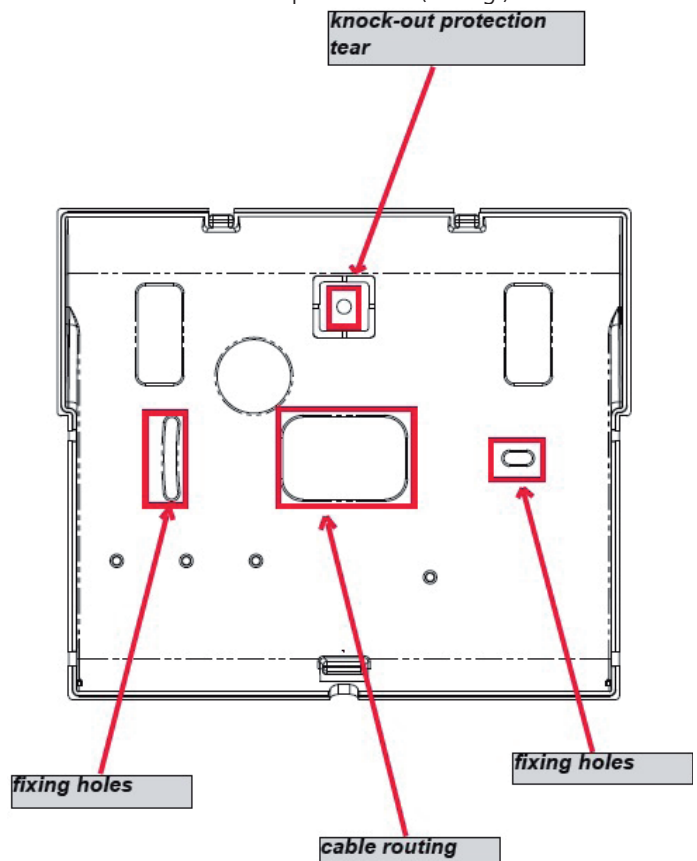
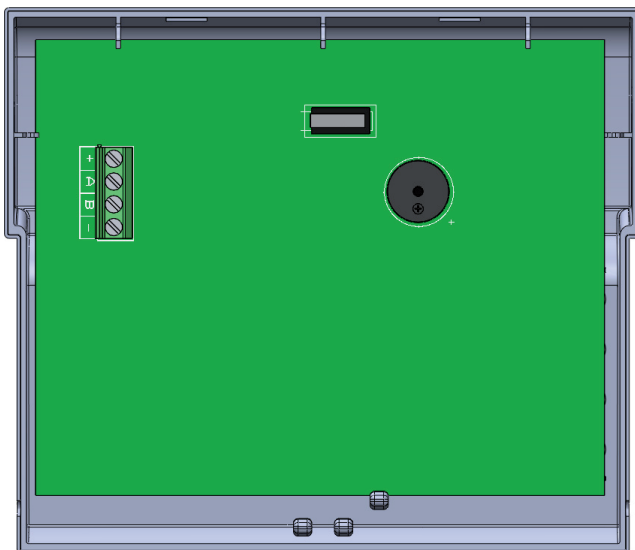

Power supply voltage: 13.8Vdc
 Rated current: 25mA
 Maximum current: 160mA

KX MODULES: KXIN - KXOUT

KXin is a module of expansion input. Can be used with the following model of panel:

- K4 panel** (1 module)
- K8 panel** (2 modules)
- K8PLUS panel** (7 modules)
- X412 panel** (1 module)
- X824 panel** (2 modules)
- X864 panel** (7 modules)

KXout is a module of expansion output. Can be used with the following model of panel:

- K4 panel** (1 module)
- K8 panel** (2 modules)
- K8PLUS panel** (4 modules)
- X412 panel** (1 module)
- X824 panel** (1 modules)
- X864 panel** (4 modules)

The expansion modules are contained in ABS protected box.

This modules must be connected directly to the RS485 bus from panel, most important before power the panel, set the address of each connected module. All module start from addres n° 1.

Eg. if you have 3 connected module the addresses are 1-2-3, if you have another 2 OUT (**KXout**) modules the addresses will be 1-2. The addresses can be set with **dip switch** on board (follow setup scheme).

KX modules are certified* **CEI 79-2:1998+Ab:2000, CEI EN 50131-3:2009 e CEI EN 50131-6:2008 Grade: 2.** Certifier **IMQ – Sistemi di sicurezza.**

* **after specific programming**

The main features are:

SPECIFICATIONS	KXin	KXout
Supply	10 - 14.5Vcc (nominal 13.8Vcc)	10 - 14.5 Vcc (nominal 13.8Vcc)
Current	31mA@13.8V	75mA@13.8V
Zones	8 for each module	-
Outputs	-	3 free contact relay outputs (30V 1A)
Protection	antiopening / back tamper	antiopening / back tamper
Bus	tamper connections monitored	tamper connections monitored

FIXING HOLES

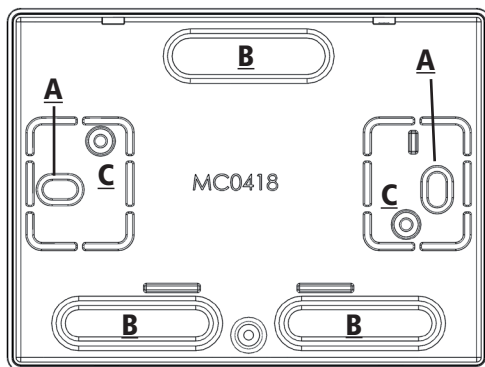

Knock out (where necessary) the points B, for cable entry.

Fix the bottom of the box plastic, with 2 screws at points A

Fix the board at points C

NOTE: The fix points A, also serve for the back tamper system

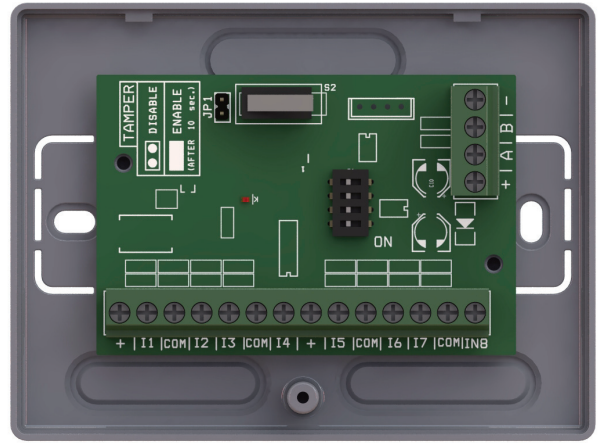
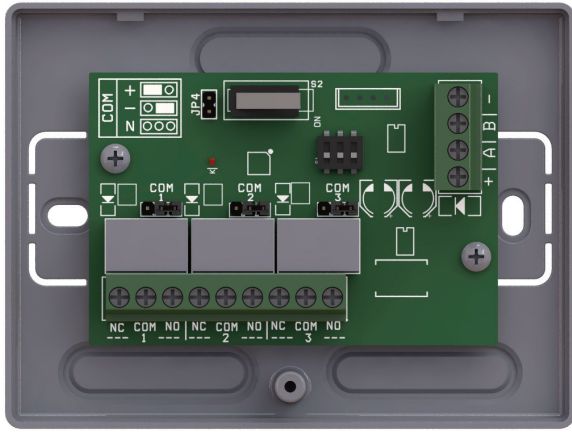

KXin TERMINALS

- (+ -) = power supply nominal 13.8 Vcc
- + A B - (RS 485) = bus terminals
- + = out terminal 13.8Vcc
- I1-I2-I3-I4-I5-I6-I7-I8 = input terminals
- COM = negative reference for inputs
- JP1 = jumper for enable or disable opening and back tamper

KXin BOARD DESCRIPTION

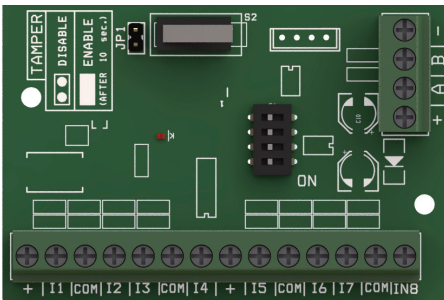

DIP-Switch Configuration

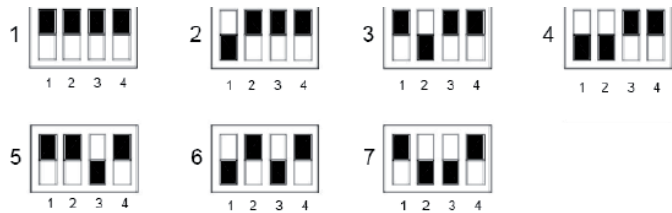

Note: in CONFIGURATION 1 ALL DIPSWITCHES ARE OFF

KXout TERMINALS

- (+ -) = power supply nominal 13.8 Vcc
- + A B - (RS 485) = bus terminals
- 1 - 2 - 3 (NC COM NO) = free realay contact
- JP4 = jumper for enable or disable opening and back tamper
- jumpers COM 1-2-3 = COM terminal reference

KXout BOARD DESCRIPTION

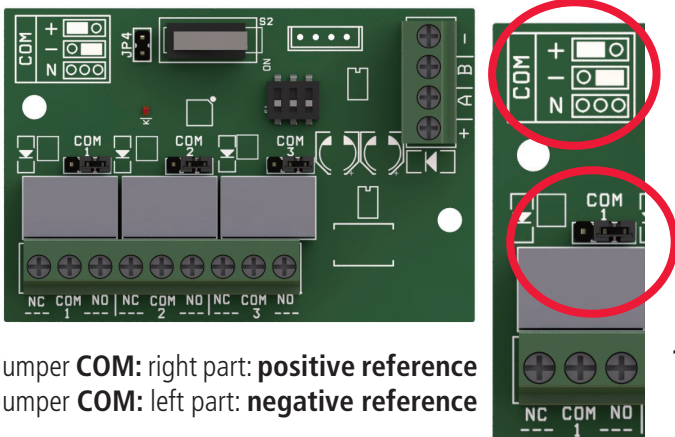

DIP-Switch Configuration

Note: in CONFIGURATION 1 ALL DIPSWITCHES ARE OFF



Jumper COM: right part: positive reference
 Jumper COM: left part: negative reference

IP1 MODULE

IP1 is the module to connect the panel in to the web for AMC Cloud (smartphone app managing), and for sending monitoring station data via web.

Is plugged directly on the main board of panel in SOCKET EXP:

INSTALLATION ON PANEL

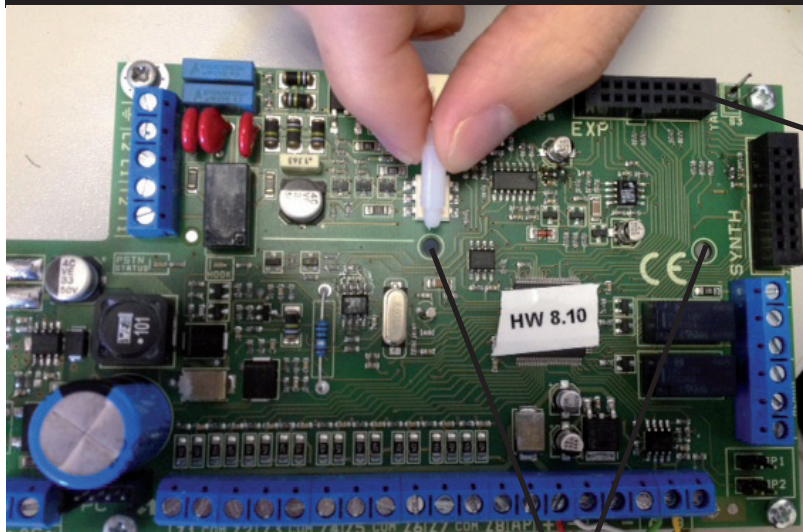

socket for ip board

board fixing pins

socket for XGPRS board



ip board

Panel with ip board

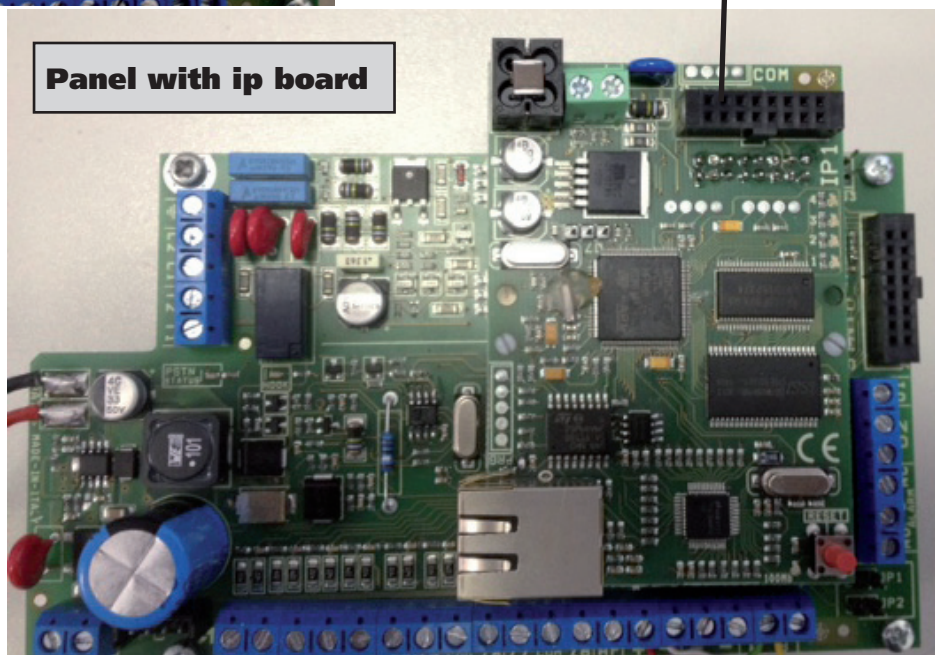
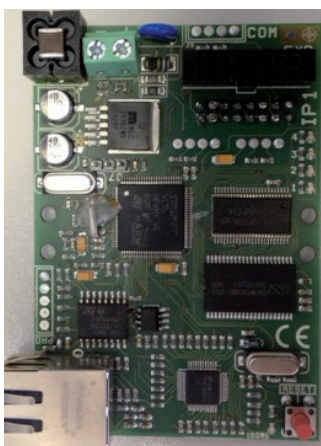

IP1 BOARD DESCRIPTION

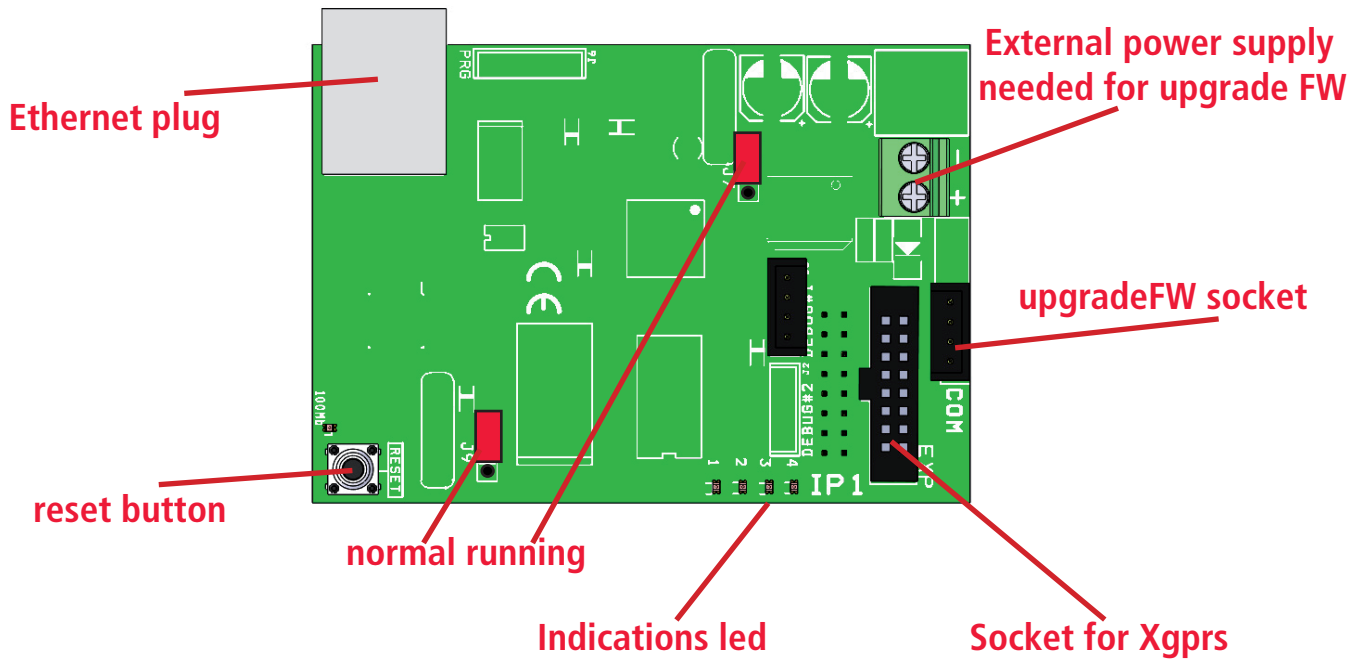

SPECIFICATIONS IP BOARD

SPECIFICATIONS	ip board
Power supply:	5-13,8Vcc
Current:	163mA @ 12V
MPU:	ARM® Cortex™-M3
RAM:	512KB
ROM1:	8MB
ROM2:	64KB
SYS:	RTOS v7.2
LAN:	10/100 BASE TX IEEE 802.1x Full Duplex
PROTOCOL:	Base: TCP/IP Encrypt: TLS/SSL Data: AMC Protocol V1.0 for system serie C-X-K
LED:	GREEN ON = OK "communication to system ok". GREEN BLINKING = FAIL "no comunication to system" (Enable IP expansion on menu) YELLOW BLINKING = system running. RED 1 BLINKING = FAIL to connect to cloud server. "wait to connetting" RED2 BLINKING = Cable not connect;
BUTTON:	RESET = ONLY LAN BOARD
J7-J9:	NORMAL RUNING. JP7: 1-2 close JP9: 1-2 close
J7-J9:	FIRMWARE UPDATE. JP7: 2-3 close JP9: 2-3 close
COM:	DAPTER: COM-S,COM-USB (only for FIRMWARE UPDATE).
classification	ATS3/SP3 refered to EN 50136-2:2013 (to ensure the classification SP3 the periodic test call must be programmed for work every 30' minutes, or for have classification SP2, the periodic test call can be programmed for work every 25h)

XGPRS MODULE

XGPRS is the module for connect the panel in to the web for AMC Cloud (smartphone app managing), and for sending monitoring station data with a GSM data SIM.

Is plugged directly on the main board of panel in SOCKET EXP, or on the IP1 socket like a backup for IP1 board.

When the XGPRS is plugged it is possibile choose the priority of message sending (see manual below)

INSTALLATION ON PANEL

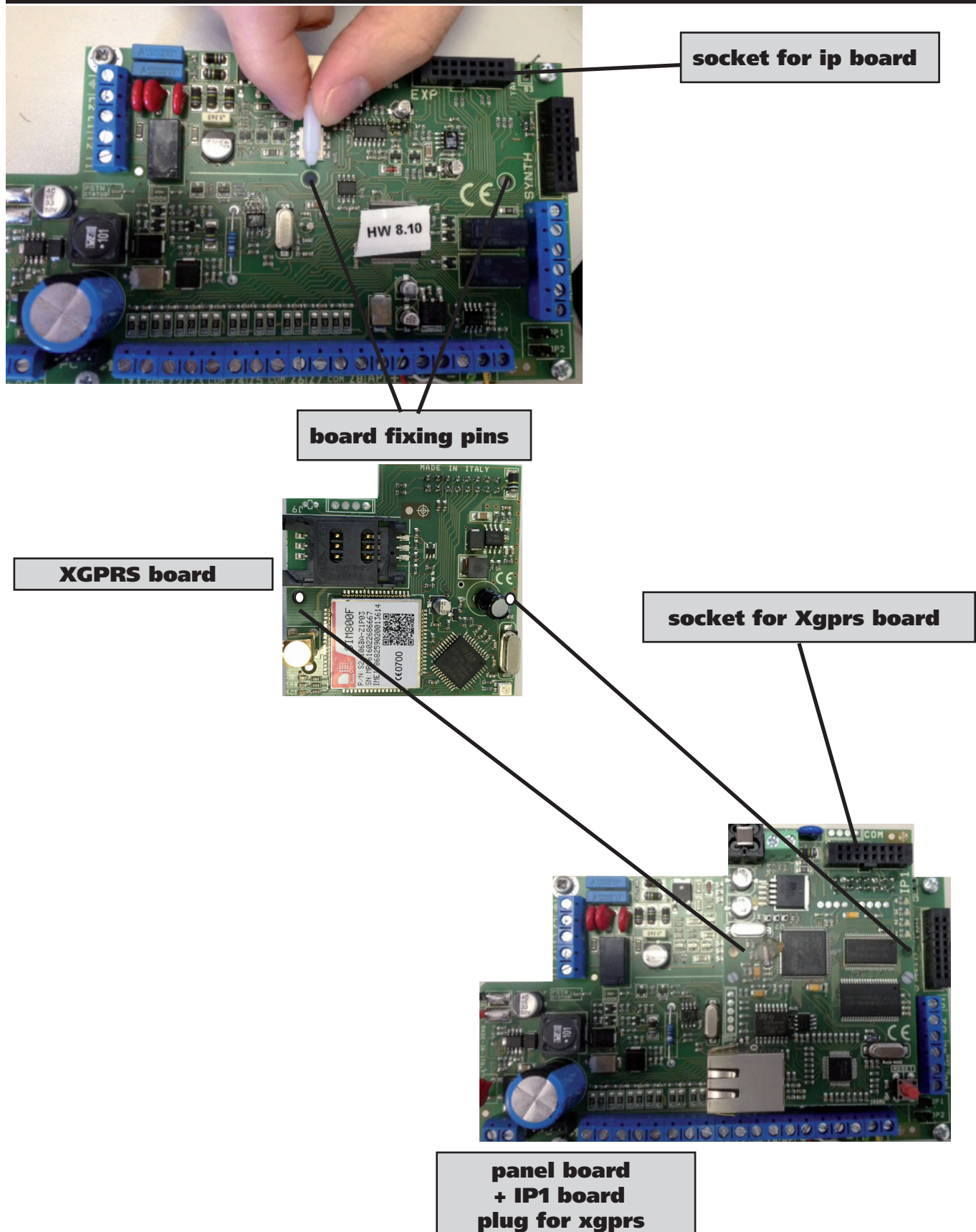

IP1 BOARD DESCRIPTION

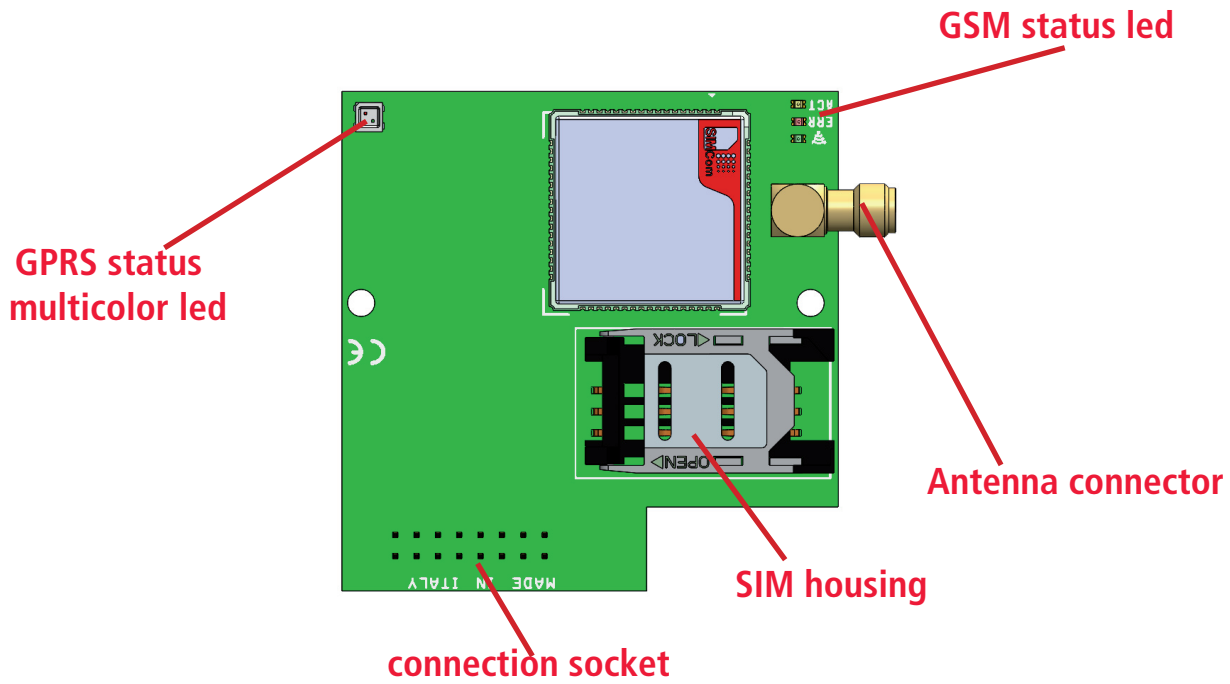

SPECIFICATIONS XGPRS BOARD

SPECIFICATIONS	XGPRS board
Power supply:	Vnom. :13,8Vcc
StandbyCurrent:	50mA @ Vnom.
Max Current	I _{max} : 380mA
Mobile engine:	SIM800F Quad-Band 850/900/1800/1900MHz, GPRS multi-slot class 12/10, GPRS mobile station class B
GSM	Compliant to GSM phase 2/2+
Classification	ATS3/SP3 referred to EN 50136-2:2013 (to ensure the classification SP3 the periodic test call must be programmed for work every 30' minutes, or for have classification SP2, the periodic test call can be programmed for work every 25h)

LED DESCRIPTION

LED	function	action	description
green	signal	1 blink	Low
		2 blink	sufficient
		3 blink	good
		4 blink	excellent
yellow	module activity	OFF	Not Ready
		ON	Ready
		slow blink 1sec.	outgoing call or SMS
		fast Blink 100ms	Ingoing Call
red	inizializazion	OFF	operating coorect
		ON	inizialization error
multicolor	GPRS Status	OFF	not used
		Steady green	ready
		green flash (4")	in use on Cloud
		blink green 100ms	data sending
		1sec. green blink	data receiving
		blink orange 100ms	in connection
		blink orange 1sec.	Cloud comunication for connect
		red steady on	Error inizialization

CONNECTIONS - SERIAL BUS

The peripherals (keypads, expansions, sockets, etc.) are connected to the electronic board through an RS485 line, terminals A and B. This connection complies with the generally adopted rules for this type of line. The maximum length of the entire bus section can be up to about 1000m.

When cabling is done over large distances, over 400/500m, certain precautions must be taken:

- It is best to use twisted cables suitable for serial lines
- It is best to connect all the peripherals in cascade (with the traditional enter and exit)
- avoid making too many junctions on the line
- avoid making too many nodes or star connections with several branches

For the use of cables that also have 2 power supply conductors for the peripherals themselves, there are no special precautions. You must keep in mind the consumption level and that the distances do not cause high voltage drops. From the peripherals you can also supply all of the sensors connected to it with no operating problems. The bus supply terminals supply 13.8Vdc - 3A protected by an independent, self-resetting fuse.

If connecting supplementary power supplies, remember that the negatives must always be in common and that the technical characteristics must be identical to those provided by the manufacturer (see the technical data)

note: all of the devices that can be connected START WITH ADDRESS 1 (ex. keypad 1 - socket 1 - expansion 1 - expansion 2)

CONNECTIONS - SIRENS

Terminal +C is used for lounch siren with missing positive configuration, when the system is ready not in alarm status, there is a positive. When the panel go in alarm, the positive go to 0Vcc.

Terminal +PZ is used for lounch piezo siren, when the panel go in alarm in this terminal you have voltage for lounch siren.

Terminals **NC - NO - COM** are free exchange alarm terminals and are done using a traditional relay. (max current 2A - 30Vdc)

AP is the terminal enabled for anti-opening protection. The reference is negative. It can be configured as NORMALLY CLOSED or as BALANCED at 1K (putting in series on the line, a resistor with that value) This parameter is found in OTHER PARAMETERS.

Note: you can also use output 1 for functions linked to the siren in order to have independent signalling of the internal siren based on the alarm zone. Or for controlling the siren flasher with separate siren/flasher commands, using a possible alarm log signal (function can be activated from the outputs menu).

CONNECTIONS - LOADS

The voltage supplied is 13.8Vdc. with 500mA or 1A see the electric spcification.

CONNECTIONS - OUTPUTS

All outputs, except no. 2 in K8 models and no. 1 in X models, are the OPEN - COLLECTOR type, with a maximum current of 80mA. Outputs are controlled by a traditional free exchange relay (max current 2A - 30Vdc).

For connection to the O.C. outputs, the closure is negative and the current, as mentioned above, is a maximum of 80mA. It is therefore considered to be an open output when not closed/connected to negative. For relay connections or other types of low absorption loads, use a positive as reference (positive supplied on the output group terminal) or any positive that has the negative in common with the one on the control unit.

You can also use the outputs with the PULL UP resistors (value 1K) to vary the reference voltages, ex. to have positives and negatives that change based on a certain programmed event.

Following are a few examples of O.C. output connections:

CONNECTIONS - ZONE TERMINALS

The control unit has 4/8 zones (from Z1 to Z8) that can be connected using various methods, NC - NA - single BALANCING - double BALANCING and TRIPLE BALANCED, or with split zone (only K series).

With split zone (only for K series) it is possible to have different zone, 2 or 3 separate zone directly on 1 terminal. For EOL resistor it is possible to select different value, with different combination.

The following is the diagram for connecting the zone inputs:

1 EOL resistor, with selectable resistor values: not certified EN 50131

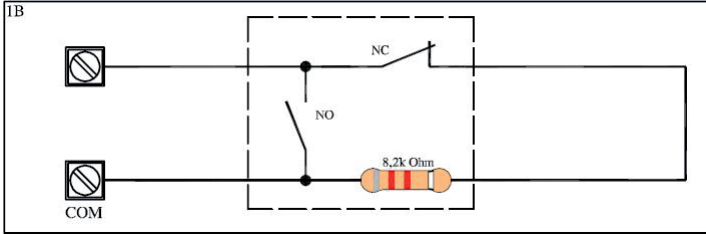
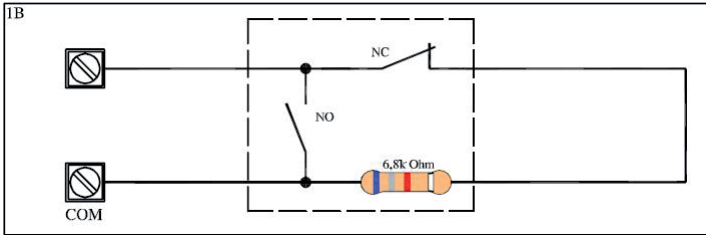
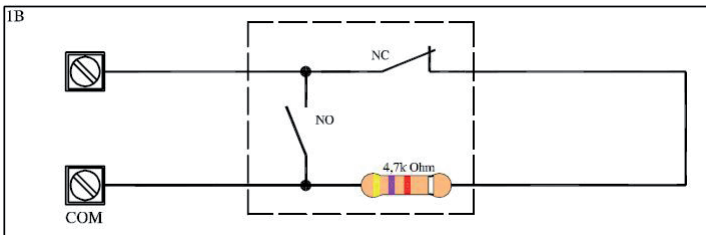
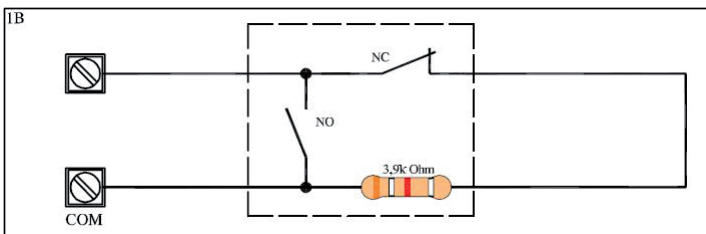
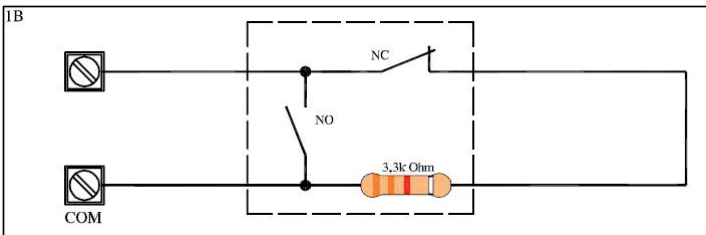
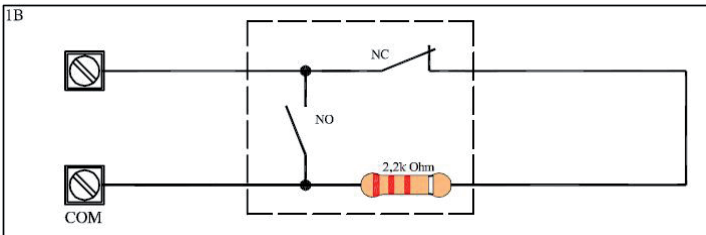
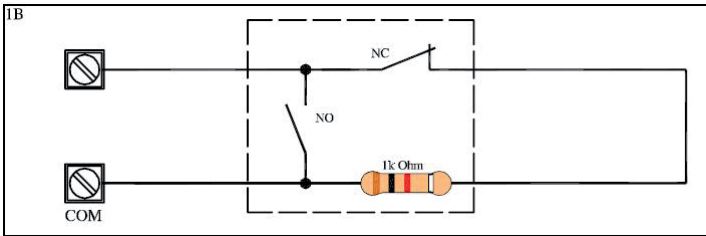

2 EOL resistors, 1 zone with cut and short circuit protection, follow selectable resistors values: certified EN 50131

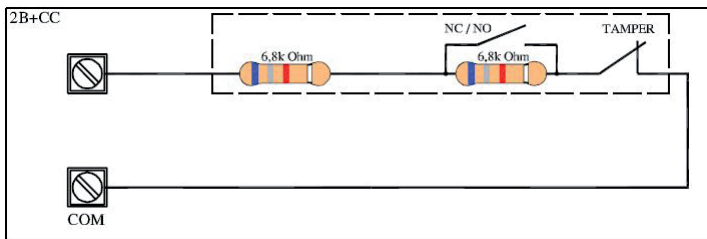
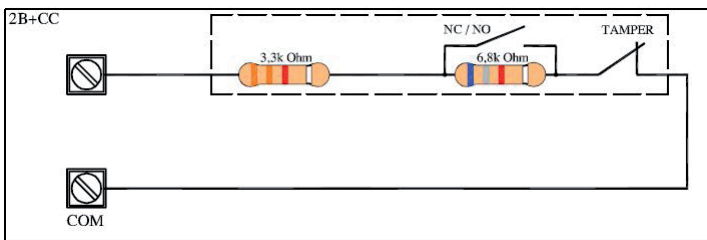
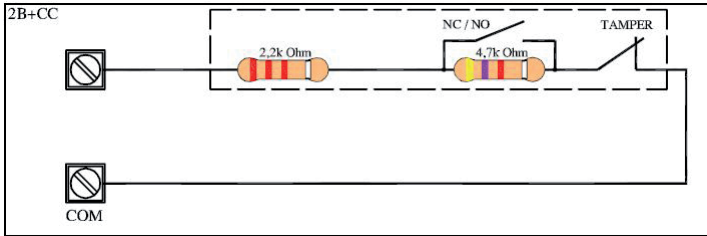
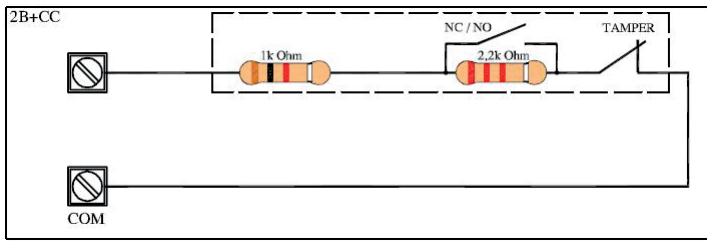

2 zones with cut wire protection, follow selectable resistors values: not certified EN 50131

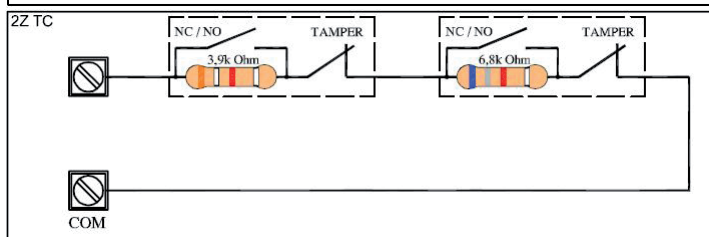
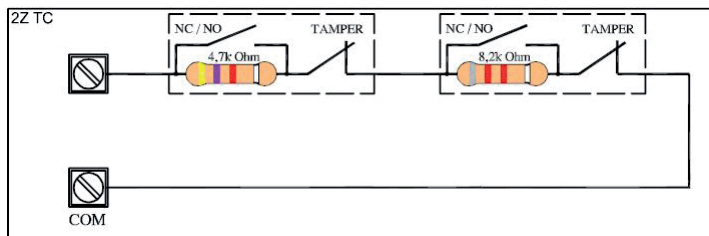
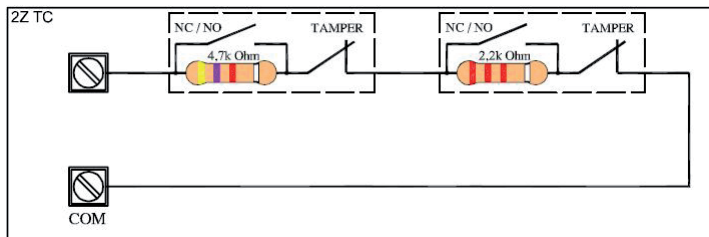

2 zones with cut and short circuit protection, follow selectable resistors values: certified EN 50131

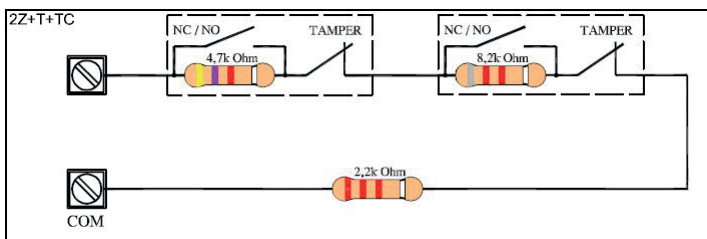
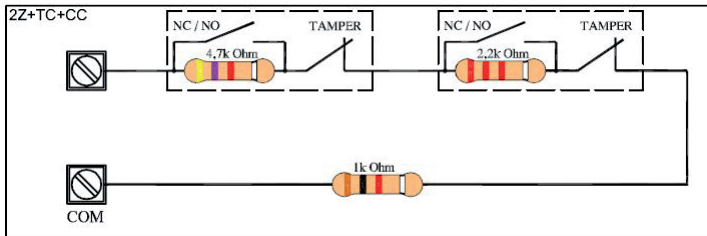
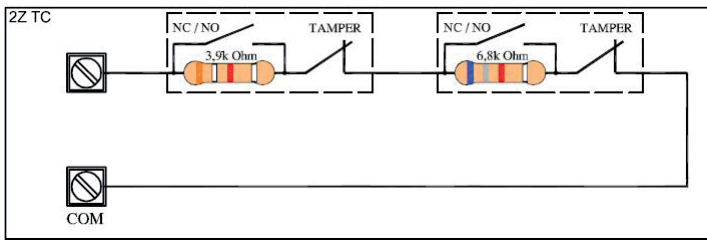

Triple EOL protection: ALARM - TAMPER - MASKING not certified EN 50131

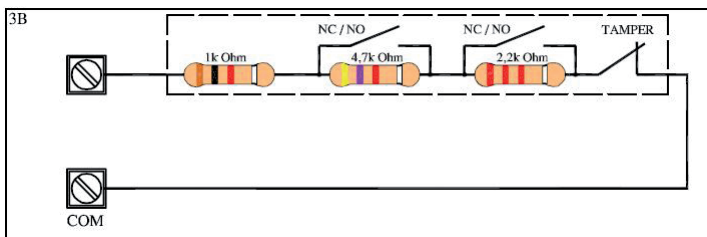

3 zones with cut wire protection: not certified EN 50131

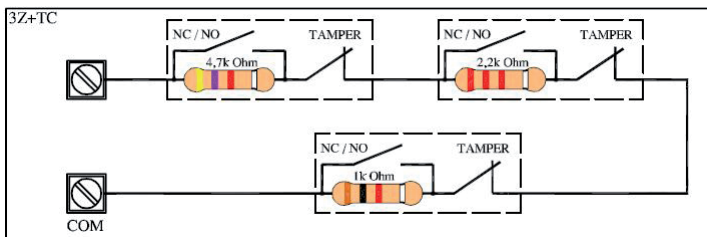

CONNECTIONS - PSTN TELEPHONE LINE

Control unit has 2 terminals (L1 and L2) that can be used to connect it to the public telephone line. In case of use of telephone lines with INTERNET access is recommended to use specific filters upstream of the connection with the control unit.

Terminals T1 and T2 are used to connect telephones. When control unit make a call it release the internal phones.

CONNECTIONS - BATTERY TERMINALS

The control unit has two buffer battery charger terminals The batteries that can be connected is 7Ah.

The maximum charging current is about 450/500mA with a voltage of 13.8Vdc.

They are protected from polarity inversion and short circuits. The charging system is intelligent. It recognizes the charge applied and adjusts the current.

IMPORTANT: If there are no batteries on the terminals there is no measurable voltage. The system stops delivering voltage when it does not find the battery charge.

TAMPER SWITCH KEY

The board is also equipped with a TAMPER terminal. To be used, with the tmper package (see instruction) Afterwards, enable the protection from the related menu (other parameters)

PC CONNECTOR

There is a 4-pole connected on the board called PC. This is for programming the control unit using PC Software. For programming you must use the optional COM S accessory.

Refer to the specific paragraph for details.

PERIPHERALS THAT CAN BE CONNECTED

K-LIGHT

Up to a maximum of 8 keypads can be connected. (8 for X series and 4 for K series)

The keypads must be connected to the BUS-485 line with the respective terminals A, B, +12V and -.

After power, the keypad automatically configures the address (visible directly in LCD). For modify the address press in the same time **X** and **V buttons** (see the istration for K-LIGHT)

K-LIGHT PLUS

Up to a maximum of 8 keypads can be connected. (8 for X series and 4 for 8 series)

The keypads must be connected to the BUS-485 line with the respective terminals A, B, +12V and -.

After power, the keypad automatically configures the address (visible directly in LCD). For modify the address press in the same time **X** and **V buttons** (see the istration for K-LIGHT)

In K-light plus there are 2 line that be programmed like input and/or output. See on Peripheral menu how to program these terminals. It is possible use these zone in all place except on board (eg. on panel from 01 to 08 is not possible, it is possible from zone 09). For output configuration you can increase the total number of output from panel that is connected (k light plus).

K-LCD AND K-VOICE TERMINAL

Up to a maximum of 8 keypads can be connected. (8 for X series and 4 for K series)

The keypads must be connected to the BUS-485 line with the respective terminals A, B, +12V and -.

Before providing power to the system, in order to differentiate the peripherals, you must address the keypads using their microswitches (DIP-SWITCHES), referring to the following figure.

To connect the K-LCD VOICE keyboard audio, we recommend using an external conductor on the bus cable to avoid any disturbances. The cable must be connected between the PHONE terminals side (see board figure) and the SPK terminal on the K-LCD VOICE keyboard.

note: To enable anti-opening protection, open the jumper on the back of the board

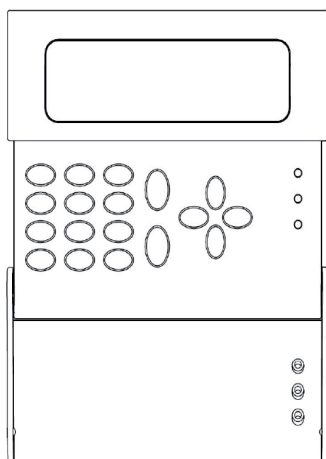

DIP-Switch Configuration

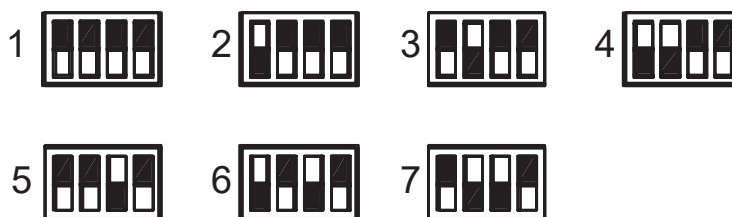

Please Note: in CONFIGURATION 1 ALL DIPSWITCHES ARE OFF

K-RADIO KEYPADS not certified EN 50131

The K-radio keypad has a 32 device radio receiver. It connects to the control unit through bus 485 line. A maximum of 2 can be connected to the control unit, therefore each keypad with a radio receiver will take a spot in the total number.

Important: address the keypads with receivers always at the first two spots.

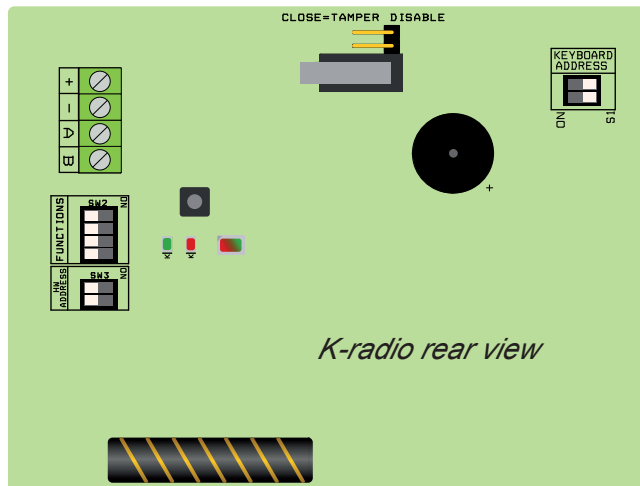

On the back of the keypad there are two pairs of dipswitches with 2 selectors:

- keyboard address = the address tied only to the keypad function
- HW address = address tied only to the radio receiver section

The other dipswitches on the board are to be left in the OFF position. Even the LED indications don't need to be checked. All of the indications for the device operation are visible on the keypad.

note: To enable anti-opening protection, open the jumper on the back of the board

INPUT EXPANSIONS "KXIN"

The control unit has 4/8 inputs, which can be expanded by using the optional Expin module.

The module must be connected to the BUS-485 line with the respective terminals A, B, +12V and -.

Before providing power to the system, in order to differentiate the peripherals, you must address them using their microswitches (DIP-SWITCHES), referring to the following figure.

DIP-Switch Configuration

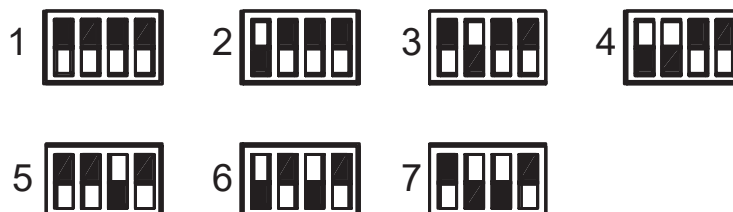

Please Note: in CONFIGURATION 1 ALL DIPSWITCHES ARE OFF

OUTPUT EXPANSIONS "KXOUT"

The control unit has 1/2 outputs, which can be expanded by using the optional Expus module.

The module must be connected to the BUS-485 line with the respective terminals A, B, +12V and -.

Before providing power to the system, in order to differentiate the peripherals, you must address them using their microswitches (DIP-SWITCHES), referring to the following figure.

DIP-Switch Configuration



Please Note: in CONFIGURATION 1 ALL DIPSWITCHES ARE OFF

For the use of O.C. outputs, refer to the manual, paragraph CONNECTIONS - OUTPUTS.

EXPR/S RADIO EXPANSION not certified EN 50131

The 32 device radio receiver is connected to the control unit through the bus 485 line. A maximum of 2 can be connected to the control unit.

There are 2 pairs of dipswitches with 2 and 4 selectors:

- HD ADR = the address
- Tied to the radio receiver section

Follow the drawing below for coding the bus address.

Note: dipswitches with 4 selectors only use dipswitch no. 3 which enables the cover anti-opening protection. (LEAVE THE OTHER DIPSWITCHES OFF)

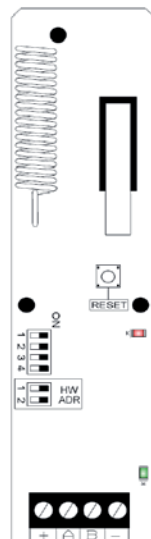

DIP-Switch Configuration

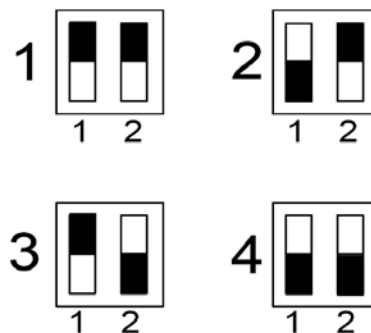

Please Note: in CONFIGURATION 1 ALL DIPSWITCHES ARE OFF

Please Note:
in CONFIGURATION 1 ALL
DIPSWITCHES ARE OFF

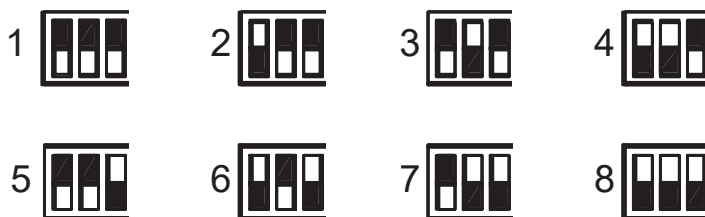

Programmable signalling LEDs

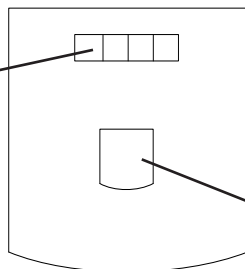

Courtesy LEDs notify of key reading and remain lit to indicate that the reader is processing the operation. You can move the key close to it again once the lights go out.

How it is used:

Move the tag close to the internal frame on the reader. The courtesy lights and arming signalling LEDs will light up at the same time to indicate the chosen program. Move the key away when the chosen arming type is displayed. (total, partial 1, etc.)

NOTE: all tampers must be closed for the device to operate properly

PROXIMITY SMALL not certified EN 50131

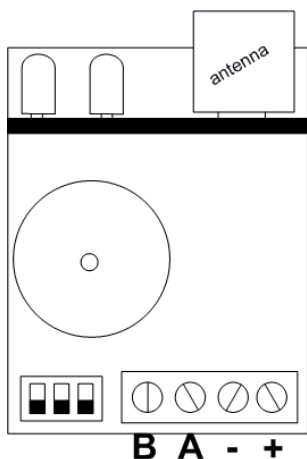

Please Note: in CONFIGURATION 1 ALL DIPSWITCHES ARE OFF

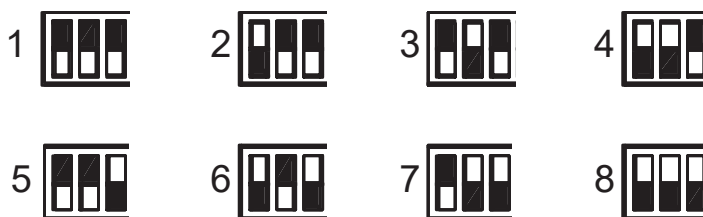

How it is used:

Bring the tag near the key reading area (see fig.) on the reader. The arming signalling LEDs will activate to indicate the chosen program. Move the key away when the chosen arming type is displayed.

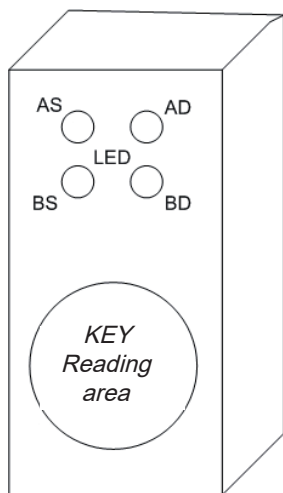

IMPORTANT: individual LEDs for each type of reader can be freely associate with each partial. Therefore, you can have readers with LEDs that activate different programs depending on their position in the site to be protected

FIRST START UP

Once all of the connections are complete, especially those tied to the serial bus, you can power up the control unit.

When you remove power from the control unit, you will not lose any data, including the date and time.

Once you have powered it up, check the following:

- Keypad no. 1 must communicate properly with the control unit. The date and time and the word "maintenance" must appear
- make sure that the control unit has no system error notifications such as no battery or no 220Vac, etc. You can check this through a quick consultation of the notifications by pressing the CANCEL key once followed by an enabled code. (default: MASTER 111111).

Note: pressing the CANCEL key will give you other system information (battery status, power supply, model, FW and HW version)

STARTING RESET

If you want RESET the control unit back to the starting condition, you can do different reset types:

- general parameter reset
- user code reset
- event reset (operation can only be performed by the manufacturer)

To perform the reset you must know the installer code.

For details, consult the specific paragraph in this manual.

DISARM KEYPAD STATUS

With disarmed panel it is possible to see at LCD the status of the zones not ready, also the troubles (battery low, power supply, telephone line problems with PSTN and GSM).

Pressing the cancel button, it is possible to see FW and HW version, GSM signal, and much more info from system.

PROGRAMMING (FROM KEYBOARD)

ENTER PROGRAMMING MOVE TO THE MENU

The control unit programming logic is the same as all the control units from previous series:

- ENTER INSTALLER CODE and confirm with enter key (**V**)
- CANCEL key (**X**) = for delete wrong codes and activate and deactivate assignment square when flashing
- Arrow keys UP - DOWN - RIGHT - LEFT = movements between vertical menus, horizontal zone/output selection, etc.
- Esc. button and # key = exit menu, switch to previous menu and sometimes the same function as the RIGHT arrow.
- G button = quick arming
- Alphanumeric keys = data insertion, names, etc.

THE DEFAULT INSTALLER CODE IS 000000

THE DEFAULT MASTER USER CODE IS 111111

EN 50131 CONFIGURATOR

The option EN50131 configurator is an automatic tool that change all parameters necessary to have the panel configured for EN 50131 approval. This Parameter is on OTHER PARAMETER menu, for enable the configurator switch from 0 to 1 the value, and the following parameters become like the following list:

- the option Autoexclusion for zones is disabled
- disabled the option that show not ready zones in display, for see this information needs user code
- All wired zones become double EOL protection
- Exit/Entry time is set with max time 45"
- Enable block arming for: (no power, no PSTN, no GSM, Battery low, all types tamper, trouble interconnections, wireless supervision)
- Information about STATUS of panels, LED, and zones are shown only in the first 30" during arming, after this time will be obscured
- the Info about GSM signal, FW & Hw version, PSTN status, battery, main power, are shown only under user code
- All function and info about alarm in keypad are obscured, it is possible see information only with user code
- Installer access (level 3 user) must be enabled from user code (level2)
- the Timer arming is provided of 1 minute before signals of pre arming
- For all zones that be excluded is enabled the autoinclusion function when the zones return ready
- The manipulation signal, when the system is disarmed, trig only internal siren
- During in entry time, if one sensor with immediate alarm function is triggered, immediately start external siren but the messages about it start after 30". If in this 30" time the user disarm the panel the message will be not delivered.
- If the zone with ENTRY/EXIT function remain not ready at finish the exit time, the panel block the arm and show in keypad
- Every time the panel stop arming procedure for trouble, in keypad display appear the cause that block, and start sound for 60" second. For stop sound alert set the user code.

PERIPHERALS MENU

Menu used to activate the peripheral devices attached to the bus:

- keypads
- tag reader
- remote input modules
- remote output modules
- radio modules
- GSM module
- IP1 internet board

Important: enable only the peripherals actually connected to the RS 485 bus

The peripheral assignment logic is represented with a square activated in the related menu while a dot means the peripheral is not enabled (fig.)

Keypad	12345678
ON/OFF	□□□

As you can see in the figure, keypads 1 - 2 - 3 are enabled while the rest are not.

- digit the installer code
- Use the vertical arrow keys to select the specific menu (see title)
- Press ENTER to enter. Select the specific menu using the vertical arrow keys.
- Press and confirm with ENTER until the peripheral cursor flashes
- Use the horizontal arrow keys to select the number of the desired peripheral
- Use the CANCEL key to select/unselect
- Confirm with ENTER
- Use the # or ESC. key to exit the menu

Repeat the operation for all types of peripherals you wish to enable

For keypads and tag reader, you can enable the buzzer in various ways:

K = key sound

< = Input times

> = Output Time

A = Chime

Keypad 01	K<>A
Sound	□□□ .

The enabling method is the same. In the example in the figure, the key sound was enabled along with the input and output times.

K LIGHT PLUS TERMINAL PROGRAMMING

K light has 2 terminal on board that be used like input and or outputs. For programming these terminal is necessary select the following menu from peripheral menu:

In / Out Keypad 01
1 - OFF 2 - OFF

When is selected (by press enter) one terminal, that start to blink, with vertica arrow is possible select if that terminal will be input or output and the postion (see figure)

In / Out Keypad 01
1- IN 09 2- IN 22

In the figure above the terminal 1 is a input in 09 place, the terminal 2 is input at place 22

In / Out Keypad 01
1- IN 09 2- OUT 05

In the figure above the terminal 1 is a input in 09 place, the terminal 2 is an output at place 05

After this configuration go in the input and/or output parameter and program like a normal zone or output

MENU OF TELEPHONE NUMBERS

PROGRAM THE TELEPHONE NUMBERS

There are 8 phone numbers available that can be freely associated to the individual inputs and all available events.

TEL.number [01]
00033445856456

Go to the telephone number menu

Press ENTER when the cursor flashes, insert the telephone number using the number keys.

Right or left arrow key to move within the number

Use the CANCEL key to delete

Confirm with ENTER

PROGRAM THE TELEPHONE PREFIX

For each number it is possible to set 2 different type of prefix, one for PSTN and another for GSM.

The PSTN one is used for exit from telephone exchange (eg. 0 pause number)

The GSM one has 3 characters and is used in case of difference of prefix between PSTN number and GSM number.

PREFIX TEL [01]
Pstn () GSM ()

Go to the telephone number menu

Press ENTER and with vertical arrow select number

press ENTER with orizz. arrow select where put the prefix (PSTN or GSM)

Confirm with ENTER

PROGRAM THE TELEPHONE OPTION only X series

There are 3 phone numbers option available that can be freely associated to the individual number.

TEL. OPTION ABC
Tel.1 □ □ ·

Go to the telephone number menu

Press ENTER and with vertical arrow select menu.

press ENTER with orizz. arrow select option and with X select dot or square to enable option

Confirm with ENTER

A = answer confirmation by pressing #

B = direct menu panel access (without code)

C = reset call progress

SYSTEM EVENTS MENU

LINK PHONE NUM.

The events list that can be associated to telephone numbers (**s = SMS V = voice T = sms-voice - = not associated**)

- Go to the link phone num. menu
- Press ENTER and use the vertical arrows to scroll through the available events marked with M (see list above)
- Press ENTER when the cursor flashes, use the right or left arrow key to move to the desired telephone numbers.
- Use the S button to assign the sms to the telephone numbers.
- Confirm with ENTER

S = ONLY SMS V = ONLY VOICE T = SMS+VOICE - = NO ASSOCIATION (CANC KEY)

M01/Tel 12345678
*** - Play VS-T-----**

* button pressed

fault 230V
*** - Play**

NOTE: by pressing left arrow or * it is possible to see the description of M event

Select the desired events from the assignment menu:

M1 = no main power

- now general power to the system, you can delay the SMS and voice notification from 0 to 240 min

M2 = main power return

- immediate return of the general system power supply

M3 = Low battery

- backup battery in the control unit is low, notification after 1 min. (below 10.5Vcc low, above 11.5Vcc charged)

M4 = life test

- Period lift sign test, can be set from 1 to 240 hours

M5 = no gsm network

- notification of no GSM network/signal, immediate.

M6 = tampering

- opening of the control unit, tamper line tampering, serial line tampering, balance line sensor tampering (Note: you can check the details of each tampering in the event log)

M7 = radio disturbance

- Notification of radio signals issued by other equipment on the same frequency range. It does not compromise operation.

M8 = radio saturation

- Radio signals issued from other equipment that compromise the safety of the system, radio blinding alarm. The system is no longer communicating with the radio peripherals.

M9 = radio battery KO

- Notification of low battery in a saved radio device (remote controls, sensors, contact, etc.). You can consult the event log for details regarding the device.

M10 = no supervision

- Notification of lack of supervision by the programmed radio devices. This notification is activated when the system does not receive 8 consecutive transmissions.

M11 =tamper disp.radio

- Notification of tampering with/opening of programmed radio devices

M12 = user access not enabled

- Notification of attempted access by a user with a timer blocked code. This is activated when the code is not enabled in a programmed time frame.

M13 = block from incorrect codes

- Notification of system block due to repeated access attempts by invalid user codes or codes not enabled by the timer. The event is activated after 5 attempts (The system remains locked for 10 minutes). Each reset attempt or other manoeuvre, including general shutdown of the system, resets the counter which starts the count over from the top.

M14 = anti-aggression panic

- Notification of anti-aggression panic event. It is generated by a user code programmed for anti-coercion. This code works like a normal user except it activates and emergency coercion call to the programmed numbers.

M15 = PSTN KO

- Notification of PSTN line fail event

M16 = PSTN OK

- Notification of PSTN line restore event

M17 = fault connection

- Problem of interconnection of serial BUS (communication error from peripheral)

M18 = arm failed

- block arm during in exit time (arm failed for block arm event with EN 50131 parameter enabled)

M19 = system arming

- System armed

M20 = total disarming

- system disarmed

M21 = Part. DISARMING

- Partition disarmed

CREDIT

- Notification of credit below the set threshold. This event can only be programmed in SMS mode.

ECHO

- Activation of forwarding of all incoming SMS to programmed numbers. This event can only be programmed in SMS mode.

ZONES MENU

ZONES: NAME

It is possible change the name for each input. The names are represented by numbers that are equivalent to words (see the list on the next page). These words are also used sms messages. Therefore, once the name is set in this section, you no longer need re-write sms messages. **All message can be modified in EDIT WORDS menu.**

The following is an example of the keyboard screen:

I01 - zone 01
*** -PLAYV - Edit**

I01 - Input 01
009 123 076 000

In the example above, input no. 1 was given the name door alarm input.

Where 009 = alarm, 123 = door, 076 = input, 000 = no value.

Note that each name is made up of 4 words. In this case only 3 words were used with the 000 equal to no text.

In order to change the name:

- Select the Names menu in the MENU OF INPUTS parameter. Press ENTER
- Use the down and up arrows to select the desired input, then press enter again
- Insert the numbers that correspond to the words using the number keys
- Press CANCEL to delete the existing name
- At the end, confirm with ENTER

Note: The following is a complete list of the words available. The numbers indicate the parameter to enter.

XSERIES VOCABULARY

The slot from 0 to 30 are completely editable and recordable. The following list are fix words and audio records of X series vocabulary.

031 masking	066 closed	101 local	136 main	171 temperature
032 ignition	067 5	102 skylight	137 4	172 curtain
033 on	068 conditioner	103 warehouse	138 radio	173 ground
034 working	069 freezer	104 magnetic	139 robbery	174 terrace
035 aggression	070 contact	105 tamper	140 reception	175 land
036 flooding	071 corridor	106 attic	141 reset	176 roof
037 alarm	072 kitchen	107 masking	142 network	177 total
038 high	073 front	108 matrimonial	143 back	178 3
039 entrance hall	074 right	109 shop	144 closet	179 office
040 angle	075 behind	110 night	145 heating	180 1
041 open	076 off	111 overnight	146 salon	181 output
042 accessible	077 muted	112 9	147 scales	182 open galley
043 opening	078 disarmed	113 workshop	148 secondary	183 glass door
044 area	079 2	114 ok	149 secretariat	184 showcase
045 lift	080 entry	115 8	150 6	185 volumetric
046 penthouse	081 external	116 master	151 basement	186 0
047 active	082 window	117 program	152 detector	
048 activation	083 smoke	118 program 1	153 7	
049 armed	084 garage	119 program 2	154 left	
050 bathroom	085 gas	120 program 3	155 siren	
051 balcony	086 general	121 program 4	156 attic	
052 barrier	087 garden	122 program 5	157 stay	
053 tilting	088 day	123 program 6	158 loft	
054 battery	089 great	124 program 7	159 above	
055 lock	090 group	125 program 8	160 under	
056 box	091 fails	126 floor	161 off	
057 boiler	092 failure	127 perimetric	162 shut down	
058 room	093 lighting	128 blind	163 stopped	
059 small room	094 fire	129 plan	164 room	
060 pound	095 inertial	130 small	165 study	
061 gate	096 zone	131 reduced	166 tamper	
062 cellar	097 inserted	132 pool	167 shade	
063 system	098 internal	133 door	168 keypad	
064 center	099 irrigation	134 arcade	169 tavern	
065 lock	100 laundry	135 doorway	170 camera	

KSERIES VOCABULARY (ALL EDITABLE)

0='-';	38='SYSTEM';	76='INPUT';	114='FLOOR';	152='ATTIC';
1='MASKING';	39='CENTER';	77='INSERTED';	115='PERIMETRIC';	153='STAY';
2='IGNITION';	40='LOCK';	78='INTERNAL';	116='PERIODIC';	154='LOFT';
3='ON';	41='CLOSED';	79='IRRIGATION';	117='BLIND';	155='ABOVE';
4='WORKING';	42='FIVE';	80='LABORATORY';	118='PLAN';	156='UNDER';
5='WATER';	43='COMMUNICATION';	81='LAUNDRY';	119='SMALL';	157='OFF';
6='AGGRESSION';	44='CONDITIONER';	82='LINE';	120='REDUCED';	158='SHUTDOWN';
7='SUPPLY';	45='FREEZER';	83='LOCAL';	121='POOL';	159='STOPPED';
8='FLOODING';	46='CONTACT';	84='SKYLIGHT';	122='PUMP';	160='ROOM';
9='ALARM';	47='CORRIDOR';	85='WAREHOUSE';	123='DOOR';	161='STUDY';
10='HIGH';	48='KITCHEN';	86='MAGNETIC';	124='ARCADE';	162='SOUTH';
11='ADMINISTRATION';	49='FRONT';	87='TAMPER';	125='DOORWAY';	163='SUPERVISION';
12='ENTRANCEHALL';	50='DEPOSIT';	88='ATTIC';	126='MAIN';	164='TAMPER';
13='ANGLE';	51='RIGHT';	89='MASKING';	127='PRODUCTION';	165='SHADE';
14='OPEN';	52='BEHIND';	90='MATRIMONIAL';	128='FOUR';	166='KEYPAD';
15='ACCESSIBLE';	53='OFF';	91='MODULE';	129='RADIO';	167='TAVERN';
16='OPENING';	54='MUTED';	92='SHOP';	130='COOLING';	168='TECHNICAL';
17='AREA';	55='DISARMED';	93='NORTH';	131='ROBBERY';	169='CAMERA';
18='STOP';	56='TWO';	94='NIGHT';	132='RECEPTION';	MSG170='TEMPERATURE';
19='LIFT';	57='ENTRY';	95='OVERNIGHT';	133='ENCLOSURE';	MSG171='CURTAIN';
20='PENTHOUSE';	58='ERROR';	96='NINE';	134='RESET';	MSG172='GROUND';
21='ACTIVE';	59='EAST';	97='NUMBER';	135='NETWORK';	MSG173='TERRACE';
22='ACTIVATION';	60='EXTERNAL';	98='WORKSHOP';	136='BACK';	MSG174='LAND';
23='ARMED';	61='WINDOW';	99='OK';	137='SHED';	MSG175='ROOF';
24='BATHROOM';	62='SMOKE';	100='EIGHT';	138='CLOSET';	MSG176='TOTAL';
25='BALCONY';	63='FUSES';	101='WEST';	139='RECOVERY';	MSG177='THREE';
26='BARRIER';	64='GARAGE';	102='MASTER';	140='HEATING';	MSG178='OFFICE';
27='TILTING';	65='GAS';	103='GYM';	141='SALON';	MSG179='ONE';
28='LOW';	66='GENERAL';	104='PARKING';	142='SCALES';	MSG180='OUTPUT';
29='BATTERY';	67='GARDEN';	105='PROGRAM';	143='SECONDARY';	MSG181='FAST';
30='LOCK';	68='DAY';	106='PROGRAM1';	144='SECRETARIAT';	MSG182='OPENGALLEY';
31='BOX';	69='GREAT';	107='PROGRAM2';	145='SIX';	MSG183='GLASSDOOR';
32='BOILER';	70='GROUP';	108='PROGRAM3';	146='BASEMENT';	MSG184='SHOWCASE';
33='ROOM';	71='FAILS';	109='PROGRAM4';	147='DETECTOR';	MSG185='VOLUMETRIC';
34='SMALLROOM';	72='FAILURE';	110='PROGRAM5';	148='SEVEN';	MSG186='ZERO';
35='POUND';	73='LIGHTING';	111='PROGRAM6';	149='LEFT';	
36='GATE';	74='FIRE';	112='PROGRAM7';	150='SIREN';	
37='CELLAR';	75='INERTIAL';	113='PROGRAM8';	151='RESCUE';	

ZONES MENU: TYPE

YOU can program different zones types:

- Select the Type menu in the ZONES MENU parameter. Press ENTER 2 times
- Use the UP and DOWN arrows to select the desired input, then press enter again
- At the end, confirm with ENTER
- No EOL (N.C. or N.O.)
- Switch Alarm (high speed Pulse Counter)
- Wireless
- EOL SEQUENCE:
- 1BAL 1K

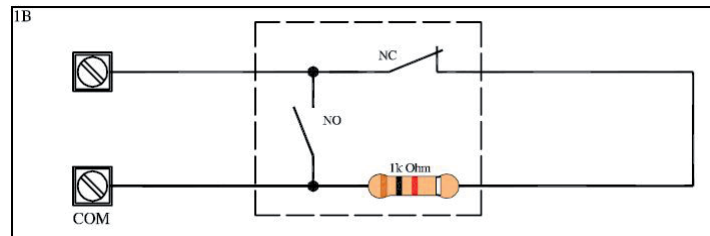

- 1BAL 2K2

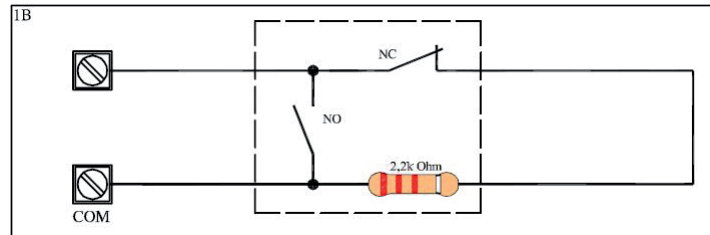

- 1BAL 3K3

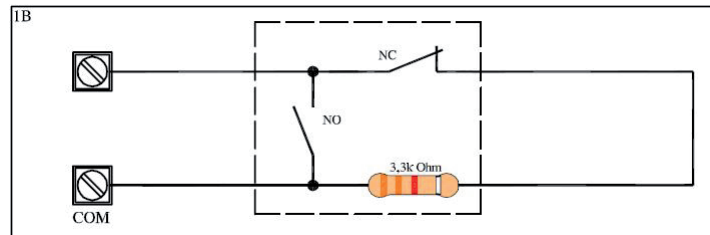

- 1BAL 3K9

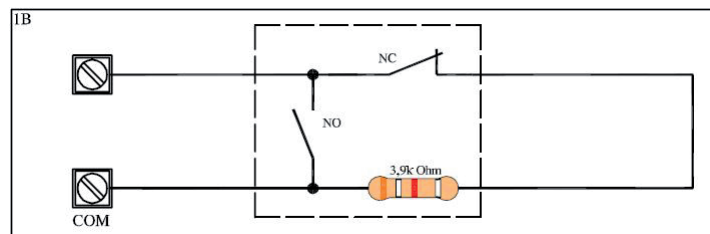

- 1BAL 4K7

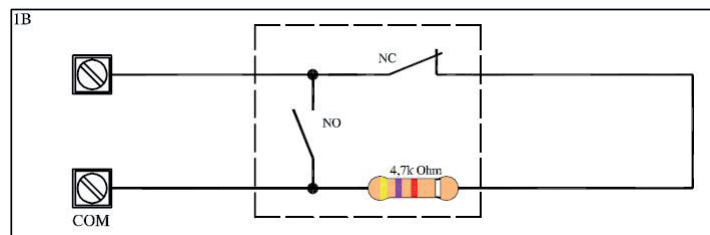

- 1BAL 6K8

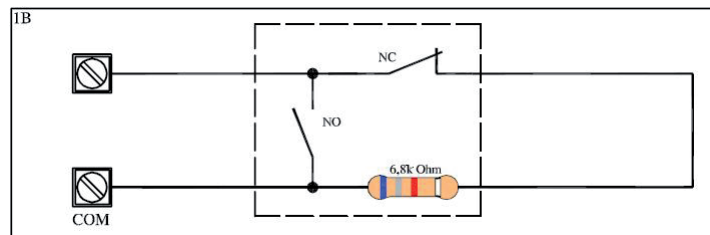

- 1BAL 8K2

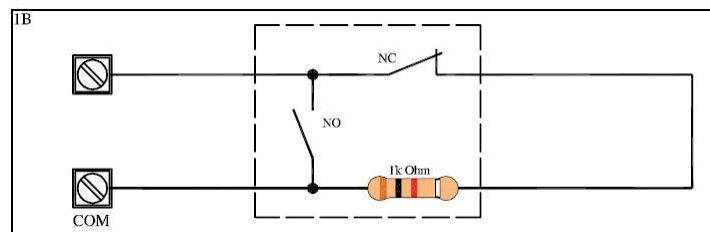

- 2BAL
- 4K7 Zone
- 2K2 Tamper

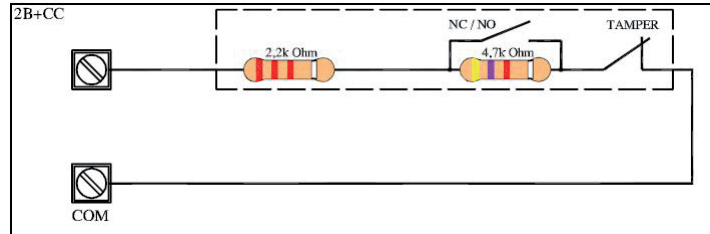

- 2BAL
- 6K8 Zone
- 3K3 Tamper

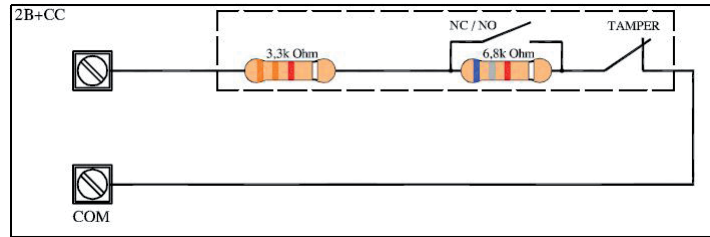

- 2BAL
- 2K2 Zone
- 1K Tamper

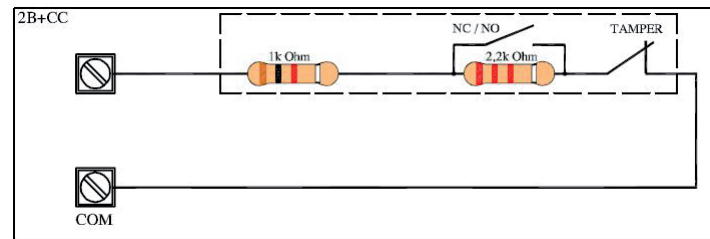

- 2BAL
- 6K8 Zone
- 6K8 Tamper

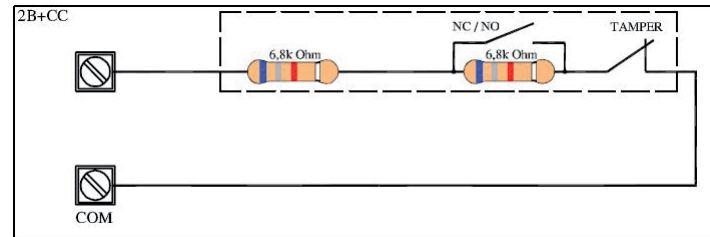

- 3BAL
- 2K2 Zone
- 1K Tamper
- 4k7 Mask

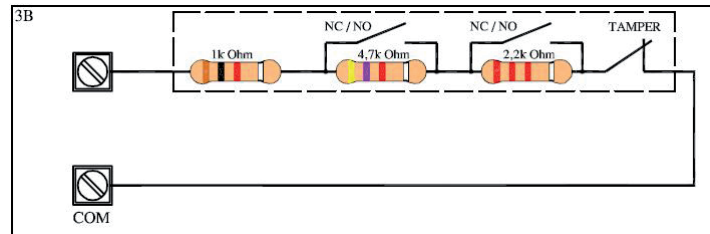

- 2 Zones
- 4K7 Zone 1
- 8K2 Zone 9

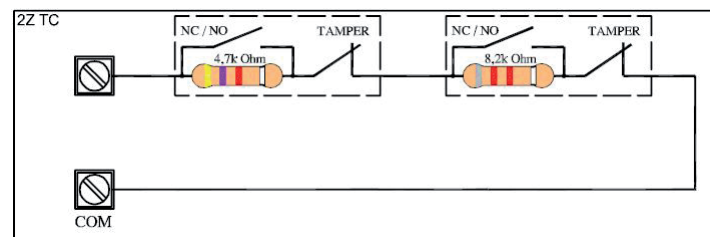

- 2 Zones
- 4K7 Zone 2
- 2K2 Zone 10

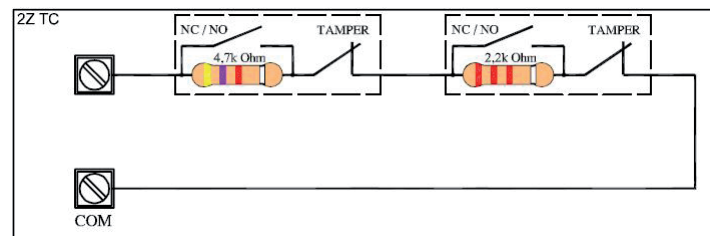

- 2 Zones
- 3K9 Zone 1
- 6K8 Zone 9

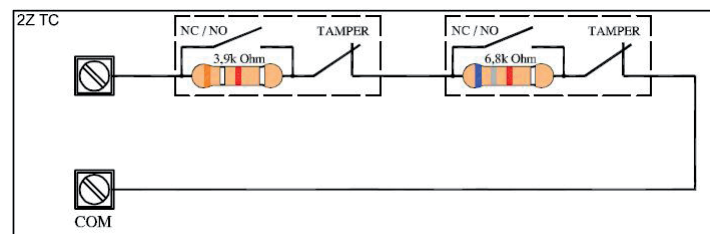

- 2 Zones
- 3K9 Zone 1
- 6K8 Zone 9
- Tamper 3K9

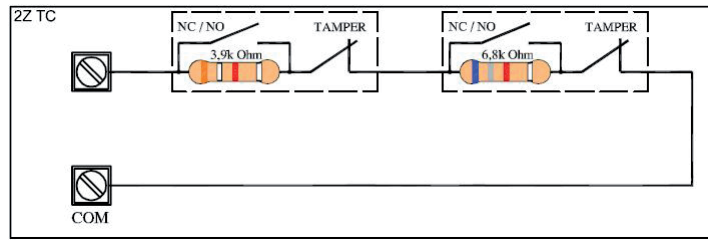

- 2 Zones
- 4K7 Zone 1
- 8K2 Zone 9
- Tamper 2K2

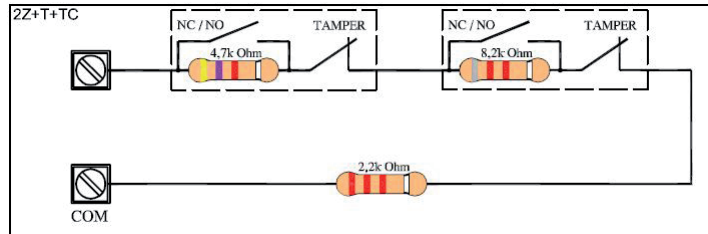

- 2 Zones
- 4K7 Zone 1
- 2K2 Zone 9
- Tamper 1K

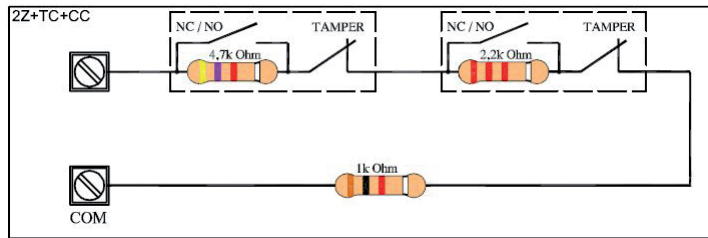

- 3 Zones
- 4K7 Zone 1
- 2K2 Zone 9
- 1K Zone 17

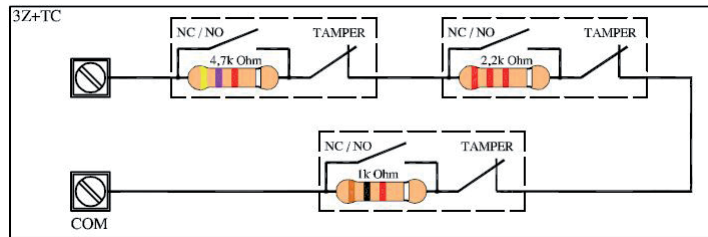

IMPORTANT: look at the table above, for determinate the configuration approved from EN 50131 (page 30)

Important: all these EOL resistor configuration is used without zones expansion. With these solutions it is possible obtain more zone without zones expansion.

Note: if you use input expansion it is possible to have single, double and triple EOL resistor balance.

Note: when the zone terminal is 2 zone split, are assigned automatically +4 for K4 and +8 for K8

eg. line 1= 2 zone spilt = Z1 and Z5 (for K4)

eg. line 1= 2 zone spilt = Z1 and Z9 (for K8)

in case of 3 zone split:

eg. line 1= 3 zone spilt = Z1,Z5,Z9 (for K4)

eg. line 1= 3 zone spilt = Z1,Z9,Z17 (for K8)

ZONES MENU: POLARITY

With this parameter it is possible change the polarity of all type of input. For example if you have programmed NO EOL type you can have N.C. or N.O. if you have a single EOL resistor type zone, you can change the polarity N.C. or N.O.

This parameter it is usable for all configuration type of inputs.



With dot the polarity is N.C. with square the polarity is N.O.

Enter in the parameter and press ENTER when the cursor flashing use CANCEL for change from dot to square.

ZONES MENU: CORRECTION

With this parameter it is possible to correct the Ohm value for each input line. If there are problem of impedance in one zone for due to long cables or bad cables, it is possible to apply a correction of the impedance in Ohm. The used scale is 10 Ohm, any correction increases or decreases the value of 10 Ohm.

Line [01]
+000

UP/DOWN
ARROWS

Line [01]
+010

UP/DOWN
ARROWS

Line [01]
-010

MENU OF INPUTS: FUNCTION

YOU can program each input with different functions:

= silent panic 24H

Generates a panic event with no visible notification (it does not take into account the system status)

A = instant alarm

Immediate alarm as soon as activated (with armed system and even during entry/exit times)

R = robbery

Immediate alarm as soon as activated (with armed system and even during entry/exit times) this function is not excludable

P = Follow

Instant alarm. It is delayed following the set times only in 2 cases, during entry time if an ENTRY EXIT input is breached and during exit time to give enough time to leave the location protected during system arming.

F = Fault

This function is used for notify an error, if the input remain open for 10 seconds start the notification error (with the programmed carrier, SMS, data etc.)

H = 24h alarm

Generates an immediate alarm regardless of the system status, whether armed or disarmed

E = entry exit

The sensor does not alarm if activated or deactivated during entry and exit times. If it remains open after those times, the system will raise an alarm.

S = only dialer with system armed (Silent Alarm, NO siren, YES in event log)

Generates an alarm event and activates the communicator with the system armed, without activating the siren.

T = double technological status

Generates a technical event without taking into account the system status, whether armed or disarmed

O = on/off

Input with step-by-step activation and deactivation function. When it is unbalanced it changes the arm status. If armed it switches to disarmed and vice versa (you can freely associate one or more partials, see the following paragraphs).

Z = only ON

Input with only a system activation function, when it is unbalanced it arms the system (you can freely associate one or more partials, see the following paragraphs)

Y = only off

Input with only a system deactivation function, when it is unbalanced it disarms the system (you can freely associate one or more partials, see the following paragraphs)

- Select the Function menu in the ZONES MENU parameter. Press ENTER
- Use the LEFT and RIGHT arrows to select the desired input, then press ENTER again
- Insert the letter that corresponds to the function
- Press CANCEL to delete the existing name
- At the end, confirm with ENTER

[01] - Input 01
RRRAAAAHHSTZY

MENU OF INPUTS: STATE

It is possible to check the zones in real time during the opening and closing phase on the synoptics panel:



The image shows a synoptics panel for "[01] entry door". It consists of a horizontal row of 12 input indicators. Each indicator is represented by a square followed by a series of dots. The first and twelfth indicators have a solid square, indicating they are open. The other indicators have a square followed by a series of dots, indicating they are closed.

The figure shows the synoptics panel, indicating inputs 1 and 12 open. The opening is represented by the square. The areas at rest are represented by the dot.

- Select the Status menu in the MENU OF INPUTS parameter. Press ENTER
- Use the LEFT and RIGHT arrows to select the desired input

ZONES MENU: ALARM PULSES

For each zone you can set the number of pulses before itself triggers the alarm.
The parameter ranges from 1 to 100. The reset threshold is 1 minute.

- Select the alarm pulses menu in the ZONES MENU parameter. Press ENTER
- Use the up and down arrows to select the desired input, then press ENTER again
- Enter the desired value by Press CANCEL to delete and re write
- At the end, confirm with ENTER

ZONES MENU: EXCLUSION CYCLES

For each zone you can set the number of pulses before bypass for trouble for many alarms.
The parameter ranges from 1 to 10, and reset with disarm.

- Select the exclus. cycles menu in the ZONES MENU parameter. Press ENTER
- Use the up and down arrows to select the desired input, then press ENTER again
- Enter the desired value by Press CANCEL to delete and re write
- At the end, confirm with ENTER

ZONES MENU: PROGRAMS ON/OFF

It possible to associate the desired partials to each ZONE programmed with the ON/OFF function:



The image shows a synoptics panel for "I01/Prg". It consists of two rows. The first row shows "I01/Prg" followed by the numbers "12345678". The second row shows "Input one" followed by three squares and a dot. The three squares correspond to the numbers 1, 2, and 3 in the row above, indicating that these partials are associated with input 01.

In the figure above, partials 1 2 3 were associated with input 01. The square indicates the associated partials, the dot indicates those not associate.

- Select the Partials ON OFF menu in the MENU OF INPUTS parameter. Press ENTER
- Use the up and down arrows to select the desired input, then press ENTER again
- Enter the desired value, pressing CANCEL on the partial desired when the cursor flashes
- Press CANCEL to delete
- At the end, confirm with ENTER

ZONES MENU: USERS ON/OFF

Is needed to associate a user to each input programmed with the ON/OFF function. This is to recognize the user and so he can manage the remote controls as a true user.



The image shows a synoptics panel for "[25] input 25". It consists of two rows. The first row shows "[25] input 25". The second row shows "User" followed by the number "10", indicating that user 10 is associated with input 25.

In the figure above, user 10 was associated to input 25 (programmed with the ON/OFF function)
Therefore, the remote control associated to the input will take on the identity of user 10.

- Select the Users ON OFF menu in the MENU OF INPUTS parameter. Press ENTER
- Use the up and down arrows to select the desired input, then press ENTER again
- Enter the desired value when the cursor flashes
- Press CANCEL to delete
- At the end, confirm with ENTER

ZONES MENU: LOCK EXCLUSION

With this parameter it is possible prevent the bypass zone when that is open during in the arming.

[01] entry door
□ □

In the figure above, inputs 1 and 12 (the ones with the square) have been blocked. Therefore, if they are not ready, the system cannot be armed, it is possible arm only if that 2 zone are ready/closed.

- Select the **lock exclusion** menu in the MENU, press ENTER
- Use the RIGHT and LEFT arrows to select the desired input, then press ENTER again
- Enable it by pressing CANCEL when the cursor flashes
- Press CANCEL again to delete
- At the end, confirm with ENTER

ZONES MENU: TEST ENABLING

It possible put in test mode the problematic zones (false alarms or other).

In the test status the zone call only a set telephone number (number 8) and disabling the siren, all alarms generated from test zone are notified in the log, also with the test description.

[01] entry door
□ □

In the figure above, inputs 1 and 12 (the ones with the square) have been put in test status.

- Select the Enable Test menu parameter. Press ENTER
- Use the RIGHT and LEFT arrows to select the desired input, then press ENTER again
- Enable it by pressing CANCEL when the cursor flashes
- Press CANCEL again to delete
- At the end, confirm with ENTER

ZONES MENU: KEYPAD BUZZER

With this function it is possible to have an audio signal from keypad buzzer when the linking zone are open.

[01] entry door
□ □

In the figure above, inputs 1 and 12 (the ones with the square) have been enabled for the buzzer.

- Select the Enable Test menu parameter. Press ENTER
- Use the RIGHT and LEFT arrows to select the desired input, then press ENTER again
- Enable it by pressing CANCEL when the cursor flashes
- Press CANCEL again to delete
- At the end, confirm with ENTER

ZONES MENU: SIRENS ACTIVATION

This parameter determines which sensors should activate the sirens, both external and internal, separately.

2 = internal and external
E = external
I = Internal

[01] - Input 01
22222IIEE2EE22222

- Select SIREN ACTIVATION parameter. Press ENTER
- Use the RIGHT and LEFT arrows to select the desired input, then press ENTER again
- Use the number keys to define the setting
- Press CANCEL again to delete
- At the end, confirm with ENTER

ZONES MENU: ZONES DELAYS

For each zone with ENTRY/EXIT function it possible set a time. This time starts when entry/exit zone is violated with armed system.



In the figure above, a 30" delay has been set for input 25 (programmed with the ENTRY/EXIT function)

- Select the Input times menu. Press ENTER
- Use the up and down arrows to select the desired zone, then press ENTER again
- Enter the desired value when the cursor flashes
- Press CANCEL to delete
- At the end, confirm with ENTER

ZONES MENU: AUTOEXCLUSION

It is possible set automatic bypass when one zone is not ready close, during in the remote arming without keypad, with remote radio command, or with tag reader...Ext.

The exclusion **is not permanent**, is valid only for one arming procedure, when the control panel is disarmed, the zone is reincluded.



In the figure above, inputs 1 and 12 (the ones with the square) have been selected. When they are not ready, the system will automatically bypass them.

- Select the Enable Test menu parameter. Press ENTER
- Use the RIGHT and LEFT arrows to select the desired input, then press ENTER again
- Enable it by pressing CANCEL when the cursor flashes
- Press CANCEL again to delete
- At the end, confirm with ENTER

ZONES MENU: UNBYPASS

Is it possible set automatic unbypass when one zone come back close, during in the arming status. If is set with a square, the zone come back armed (when re-closed) giving alarm if violated.



In the figure, inputs 1 and 12 (the ones with the square) have been selected.

ZONES MENU: TELEPHONES LINK.

For each zone it is possible to link a sms to the programmed numbers.



In the figure the zone number 1 is linked to phone number 1 - 3 - 6

S = SMS, the system send only sms for this event

T = ALL, the system send voice call and sms

V = VOICE, the system send voice call

note: in K series without voice module, will call with bip signal (different bip signal for alarm and troubles)

- Select the telephone link menu parameter. Press ENTER
- Use the RIGHT and LEFT arrows to select the desired input, then press ENTER again
- Use the number keys to define the setting (only S)
- Press CANCEL again to delete
- At the end, confirm with ENTER

MENU OF OUTPUTS

MENU OF OUTPUTS: NAMES

It is possible to change the name for each output. The names are represented by numbers that are equivalent to words. These words are also used for sms. When the name is set in this section, in automatic it is right for SMS.

The following is an example of the keyboard screen:

U01 - Output 01
V - Edit

U01 - Output 01
079 067 003 000

The example above shows the name set for output 1 as irrigation garden on.

Where 079 = irrigation, 067 = garden, 003 = on, 000 = no value.

Note that each name is made up of 4 words. In this case only 3 words were used with the 000 equal to no text.

In order to change the name:

- Select the Names menu in the MENU OF OUTPUTS parameter. Press ENTER
- Use the down and up arrows to select the desired output, then press ENTER again
- Insert the numbers that correspond to the words using the number keys
- Press CANCEL to delete the existing name
- At the end, confirm with ENTER

Note: The words are the same of the zones.

MENU OF OUTPUTS: FUNCTION

The keypad assignment method for the output functions is identical to the procedures explained previously for zone.

- = output disabled

1 - 4 = partial arming

Follow the arming partition status

A = external alarm (siren)

follows the performance of the external siren

B = low battery

This is activated when the buffer battery is low (below 10.4Vdc)

C = system arming status

this activates when the system is armed in any scenario

D = bell buzzer

This is activated when inputs with the option buzzer are activated

E = attempted user timer access

This is activated when a temporarily disabled user by the timer, enter personal code.

F = alarm memory by siren

This function is used to pilot the sirens with separate sound command and flashing lights. When it is enabled, the flashing light can be used as an alarm memory therefore it will be activated with siren activation and will remain active even after the siren is silenced. It will only turn off after a valid user code is keyed in.

G = no gsm signal

when there isn't GSM signal

H = anti-aggression panic

This is activated following a panic even (user code, panic input)

I = activation on input opening (from zone Menu)

linked to the zone, when one zone is opening trig the on the out

L = System lock

out trig in ON when the system is locked

M = memory (red keypad LED)

follow the keypad memory signal led

N = PSTN fault (red keypad LED)

Fault PSTN line

O = total arming

when the system is total armed

R = Disarming

when the system is disarmed

P = pilot

Outputs that can be activated by a phone ring with programmed ID. The activation is step-by-step (Ring = activation --> ring = deactivation) or, if a pulse sound time is set. At each ring activation, the operation will be confirmed by an answering ring

Q = shortcut

Outputs that can be activated by holding the number key in keypad for few seconds, the output number corresponds to the number pressed on the keyboard (eg. **button 3= out 3**).

S = system control (green keypad LED follows)

follow the zones status, the same of ready led in keypad

T = timer activation

follow the period timer arming

U = user code activation (local and remote)

out linked directly to user code

V = no 230 Vac

absence mains voltage

w = Multi

Out with multi function, it is possible manage with: shortcut + usercode + app + pilot + timer

X = internal alarm (only out 1)

internal siren

Y = no radio supervision

lost radio device

Z = radio batteries low

battery low from radio device



The figure shows only the first 4 outputs programmed. The following ones, are not assigned any function. As always, the menu is the horizontal type, therefore once inside, when the cursor flashes, use the horizontal arrows to select the outputs and use the keypad to set the function.

MENU OF OUTPUTS: DURATION

A duration can be set for each output. The output with a duration of 0 is the stable type and therefore only activates with a programmed event or deactivates when it re-enters. If a duration time is set, the output will become by pulse. The pulse duration is set by this parameter.

```
[01] output 01
03 h 15 min 10
```

In the figure, output 01 has a duration of 3 hours and 15 minutes and 10 seconds. The maximum time that can be set is 17 hours, 59 minutes and 59 seconds. To set it from the keypad, go to the duration menu. When the cursors for the hour, or rather the minutes or seconds flash, after pressing ENTER, use the keypad to set the times and confirm.

MENU OF OUTPUTS: DELAY

Each output associated to a given event is activated as soon as the event itself occurs. Activation can be delayed by a time you can set. When the delay time is 0, activation is instantaneous.

```
[01] output 01
01 h 10 min 30
```

In the figure, output 01 has a delay of 1 hour, 10 minutes and 30 seconds, therefore, when an event occurs, the output will activate after that amount of time. The maximum time that can be set is 17 hours, 59 minutes and 59 seconds. To set it from the keypad, go to the duration menu. When the cursors for the hour, or rather the minutes or seconds flash, after pressing ENTER, use the keypad to set the times and confirm.

Note: A delayed activation may be reset or not based on the reset of the event that occurred. If we set a delayed output at 1 hour for no power and it comes back on before the hour is up, we can choose what to do, either not activate it or activated it after the set time (see autoreset parameter).

MENU OF OUTPUTS: POLARITY

The polarity can be set for each output. Being Open Collector type outputs, when they are deactivated that means they are not closed negative.

```
[01] output 01
00000011110000000
```

The figure shows that some outputs are N.A. (symbol 0) and some are N.C. (symbol 1).

Note: Output 2 is the only one with a free exchange relay.

MENU OF OUTPUTS: AUTORESET

This parameter must only be used for delayed outputs. The autoreset function resets the activation of a delayed output if before the activated, the triggering event is reset (also see delayed outputs)

```
[01] output 01
10000000000000000
```

The figure shows how output 1 is configured as auto reset.
Ex. 1 O1 with NO 220ac function with a 1 hour delay - the 220Vac power returns within a half hour and the output interrupts the delay and stops the activation process.
Ex. 2 O2 with NO 220ac function with a 1 hour delay - the 220Vac power returns within a half hour and the output does NOT interrupt the delay BUT CONTINUES the activation process. AFTER AN HOUR IT IS ACTIVATED.

MENU OF OUTPUTS: OPERATING CONDITIONS

For each output you can establish the operating conditions based on the system conditions.
X = function always active. As soon as the event occurs, the output activates with its times
A= only with system armed. It activates only if the system is armed.
D= only with system disarmed. It activates only if the system is disarmed
T= only Total. It activates only when the system is armed in Total mode.
1 – 4 = corresponding partial. It activates only when the partial selected is armed

[01] output 01
XTXXXXXXXXXXXXXX

In the figure you can see how only output 2 can be active and only when the system is completely armed. The remaining outputs can be activated in any conditions.

MENU OF OUTPUTS: TELEPHONES LINK.

For every output programmed with the **PILOT** function you can associate up to 8 telephones.
Remember that this type of association is for outputs that can be ring activated.
You must program the telephone numbers with the international prefix (+393354568526) to give the system the possibility of recognising the ID of the number, which must be visible.

001/Tel 12345678
output 01 □□□

In the figure you can see that output no. 1 has the first 3 telephone numbers associated out of the 8 available.

MENU OF OUTPUTS: USERS LINK

For each output programmed using the associated user function, it is possible associate several user codes.
This association allows a user to activate a stable or pulse output by simply keying in their code.
Remember that an output with a duration of 0 is stable so the operation is step-by-step (code=ON --> code=OFF)

001 - User Nr 01
□□□

In the figure you can see that output no. 1 has the first 3 users associated, therefore, when the codes for those users is entered, the output will activate or deactivate based on the status.

MENU OF OUTPUTS: INPUTS LINK

For each output programmed using the associated input function, you can associate several inputs.
This association allows an output associated to inputs to be activated based on the operating conditions of the output itself.
Ex. an input can move 2 outputs, one with the system armed (garden lights) and one with the system disarmed (entry door courtesy light)

001 - input one
□□□

In the figure you can see output no. 1 has the first 2 inputs associated.

WIRELESS MENU 868MHZ FULL DUPLEX (NOT CERTIFIED EN 50131)

The control unit can manage the radio device (sensors, contact, sirens, Etc.) These are programmable in receiver devices EXPRS and in Kradio. Radio receivers may be enabled in the PERIPHERALS MENU, and are connected on the bus.

The radio receiver can save 56 radio devices divided in different type:

- 32 devices (sensors, contact, smokesensor, etc.)
- 20 Keyfob
- 4 sirens

The radio devices that can be programmed are:

- IF800 (PIR sensor) 1 place in receiver 1 zone in panel used
- CU 800 triple contact (reed, external contact, switch-alarm contact) 1 place in receiver 3 zone can be used in panel
- CM 800 double contact (reed, external contact) 1 place in receiver and 2 zone can be used in panel
- TR 800 keyfob programmable for ON and OFF all partitons and all OUTS
- IF800 T curtain PIR sensor
- SS800 Sismic sensor
- SF 800 smoke sensor
- SRL 800 wireless only battery siren

When the wireless devices are learned to the receiver, is necessary link every device channel to the zone of panel programmed like wireless, in case of sensors and conatct. For keyfob, after learning, is necessary program the button for specific request of user. Panel support all zone wireless or mixed wired/wireless in free combinations.

When there is at least an expansion programmed, it is possible use all zone in panel like wireless without wired expansion.

It is possible use for eg. zone 3 wired(on board) and zone 60 wireless in panel with 64 zones.

It is possible have a full Hybrid system (wireless and wired) without restrctions.

IMPORTANT: before link the wireless device channel to zone, is necessary that the zone is programmed like wireless (menu zones --> zones type--> wireless)

WIRELESS MENU: LEARNING

For programming wireless device in receiver there are 2 ways:

- self learning, by sending the signal directely from device to the receiver
- copy the code of device in to the receiver, via keypad and /or via programming software

WIRELESS
EXPR1 Storing

Expr1 waiting ...
Free 56 / 56

DEVICES
Stored 00

KEYFOBS
Stored 00

SIRENS
Stored 00

SIRENS
Stored 00

025-Add
Id: -----

In figure, it is possible send the code from device (Auto-learning)

In figure above, is explained the menu for add devices with ID code

In figure above, is explained the lcd display of self learning mode and manual set code. Every new learn, the number of free device programmable decrease.

D01-Add
Id: - - - - -

In figure above, is explained the lcd display with the space for insert the code of the device (this operation can be made by programming software and from keypad). For each new device wireless transmitter is necessary put the ID code.
When all code of device (contact, PIR, etc) are stored in the receiver, it is possible set all parameters.

After that all device are stored in to the receiver, it is possible for every type of the device set the parameters.
In the screen shown, if you press ENTER you will access the list of programmed devices (fig below)

For each device, it is possible to have various parameters:
- device signal in real time (fig 1)
Averages the notifications received

D01-CU800 Nr.01
Signal ■■■■■■■■■■
(fig 1)

- battery status
The result in this case is also the average of several notifications

D01-CU800 Nr.01
Battery 70%
(fig 2)

- synoptics panel input status
You can have the open closed status of the inputs available for each device (square: zone open, dot: zone close)

D01-CU800 Nr.01
Inputs ■
(fig 3)

- Tamper status:
the system detect if the cover is closed or not

D01-CU800 Nr.01
Tamper CLOSED

- Supervision
Every 20minutes the system upgrade the supervision status.
the alert of lost supervision is shown after 2Hours of missing signals (6 time).

D01-CU800 Nr.01
Superv. OK

- ID code of device
Is used for programming the device in to the receiver. This code is unique for each device.

D01-CU800 Nr.01
Id: 0101230158

- Pulse counter (only for CU800)
is used for Switch alarm contact, it is possible set the number of pulses.

D01-CU800 Nr.01
PulsesSwitch 5

- Led of indication
it is possible enable or disable the alarm/transmission led on the device (0 = disabled 1 = enabled)

D01-CU800 Nr.01
Led device 1

- Reed contact association:
it is possible to link every alarm contact/pir/etc to the zones of panel (in eg. the reed of wireless device in linked to zone n°10)

D01-CU800 Nr.01
Reed ->Zn 10

- External contact association:
it is possible to link every alarm contact/pir/etc to the zones of panel (in eg. the external contact of wireless device in linked to zone n°10)

D01-CU800 Nr.01
EXT ->Zn 10

- Switch alarm contact association:
it is possible to link every alarm contact/pir/etc to the zones of panel (in eg. the switch alarm contact of wireless device in linked to zone n°10)

D01-CU800 Nr.01
SWITCH ->Zn 10

- Replacing a device
If a device fails, it can be replaced with an identical one, keeping the previously made associations.
Once the replacement is confirmed with ENTER, press the learn key to self-learn the new one, or change the ID code with new device code.

D01-CU800 Nr01
Replacing

- Delete device
With this menu you can delete a device and all of its associations.

D01-CU800 Nr01
Erasing

SIRENS:

The system support wireless sirens, the max number that can be programmed are 4.

The sirens work only with battery, no wired main power.

For learn the siren to the system, the method is the same like all devices, SELF LEARNING, or MANUAL ADD CODE.

In wireless menu it is possible check the parametrs of wireless section of siren:

- Range
- Battery status
- Supervision
- Id number

For set the parameters of sound duration, squawk, cycles etc. go in menu siren in other parameters.

All sirens settings are the same for wired and wireless.

KEYFOB SETUP

indication LED

key ON button

key PAR button



key OFF button

info button

* button

For keyfob it is possible program some different parameters:

- Silent panic combination buttons (info button silent, press and hold for 2 seconds)
- panic combinations (* button panic, press and hold for 2 seconds)
- link user
- partials per button, link 1 or more partitions to the every buttons
- outs per button, link out to the button
- and it is possible enable the led on key fob for the operation, all programmable

- * button for panic with siren

For the button with * simbol it is possible enable the siren panic, (1 = enable 0 = disable) if the * is pressed fo 2 seconds the system will go in siren panic

D01-TR800 Nr01
PanicWithSiren 1

- INFO button for SILENT panic

For the button with * simbol it is possible enable the siren panic, (1 = enable 0 = disable) if the * is pressed fo 2 seconds the system will go in siren panic

D01-TR800 Nr01
Silent Panic 1

- link the keyfob to the user

in figure the keyfob is linked to user n°1

D01-TR800 Nr01
User -> 1

- Link butoon of keyfob to the partitions

it is possible link one or more buttons of keyfob to the 1 or more partitions and it is possible change the function of button: ON, OFF, and ON/OFF (ON/OFF = 1 pression ON -> another pression OFF) In this LCD mask PRESS ENTER TO MODIFY. It is possible modify these parameters for all buttons.

D01-TR800 Nr01
Key TOT -> Prg

In figure is shown that the Key TOT button is programmed like only ON and are linked the partitions: 1345678

D01-TR800 Nr01
ON 1-345678

- Link button of keyfob to the Outs
 it is possible link one or more buttons of keyfob to the 1 out (function shortcut) and it is possible change the function of button: DISABLED, ON, OFF, and ON/OFF (ON/OFF = 1 pression ON -> another pression OFF) In this LCD mask PRESS ENTER TO MODIFY. It is possible modify these parameters for all buttons.

D01-TR800 Nr01
Key TOT -> Out

In figure is shown that the Key TOT button is programmed like only ON and are linked the output 1.
 IMPORTANT: the oput must be programmed like shortcut func.

D01-TR800 Nr01
ON 1

- SETTING OF LED KEYFOB
 it is possible program the led combination of keyfob in function of the type of button pressed. For eg. if you want that all 4 led flash when is pressed TOT button, link all 4 led to the TOT button.

D01-TR800 Nr01
Key TOT -> Led

In figure is shown the TOT button of keyfob with linked 4 led.

D01-TR800 Nr01
LED 1234

KEYFOB LED REPORT

After programming, when some button is pressed the keyfob report the status of command:

- 3 flash of programmed led means that the operation is a ON of the programmed thing (ARM, or output ON)
- 1 long flash of prgrammed led, means that the opartion is a OFFof the èrogrammed thing (disarm or output OFF)
- the sequence of led from right to left is the answer from panel

In case of sequence, but nothing action (only 1 little falsh by 1 led) means that the operation can not excute (eg. zones not ready)
 The info button (in the middle) normally is used for have info about the status of panel (armed/disarmed) if is in the range of wireless, the keyfob ask to the panel and show the staus, by using the led report. In case the keyfob is out range, report the status that was meorized during the last operation.

WIRELESS MENU: EXPR RESET

Each receiver module has the possibility of being reset through its own menu. When the reset is activated all memorised devices and all associations linked to it are deleted.

WIRELESS
EXPR1 Reset

WIRELESS
EXPR2 Reset

WIRELESS MENU: RSSI

It is possible check in the real time the radio disturbance percentage near the receivers. In the figure below you can see 2 different disturbance thresholds in 2 receivers.

note: the radio disturbance notification is done by the control unit when the threshold exceeds 50% for more than 5 seconds.

WIRELESS
EXPR1 RSSI 10%

WIRELESS
EXPR2 RSSI 20%

PROGRAMS MENU

The control unit has 4 programs that can be named with the following characteristics:

- Can be independently armed/disarmed
- Can be freely associated to users
- can be freely associated to arming/disarming timers
- can have independently programmable arming times
- can be clustered in activation groups, which can also be named

PROGRAMS MENU: PARTIALS NAMES

The system for assigning names to the partials is identical to the one used for inputs and outputs. The vocabulary used is the same.

P01-Program Nr.01
V - Edit

P01-Program Nr.01
009 123 076 000

PROGRAMS MENU: PARTIAL ZONES (ASSIGNING ZONES TO PARTIALS)

It is possible to associate any zones to each partial. It is possible also have the same inputs associated to several partials.

Go to the programs menu and select PARTIAL ZONE 1. Using the vertical arrow keys, select the desired partial and press enter to associate the zones (fig. below)

The figure shows the association of the first 3 zones to partial 1.

The zone assigning method is the same as the one already mentioned for other menus (inputs, outputs)

- Use the RIGHT and LEFT arrows to select the desired input, then press ENTER again
- Enable it by pressing CANCEL when the cursor flashes
- Press CANCEL again to delete
- At the end, confirm with ENTER

[01] input one
□□□

PROGRAMS MENU: EXIT TIMES

For each partial there are different output time.

When several partials are armed at the same time, the longest time is taken into consideration.

In figure on, an output time of 30 seconds was associated.

[01] program 01
[Sec.] 30

GROUPS MENU

It is possible create the arming scenarios (group), that include several partials. There are 4 scenarios, they can be armed by using the G1 - 2 - 3 - 4 keys from keypad. In the control unit menu they are called groups and some partial can be placed in arming group.

It is possible to use the group for quick arm procedure.

Note: the numbering of the groups is only an example, the program default is:

G1 = Total (all partials) - G2 = Perimeter (partials 1 - 2) - G3 = Night (partials 3 - 4) G4 = no programming

GROUPS MENU: NAMES

As in the figure, the system for assigning names to the GROUPS is always the same, including the vocabulary.

Fig 1 shows the change menu for the name, fig 2 shows the method (shown previously) to assign the names (the 3 digit numbers indicate the vocabulary, see page 34, for a total of 4 words for each name)

G01 - Group 01
V - Edit

GROUPS MENU: GROUPS (ASSOCIATE PARTIALS TO GROUPS)

associate partials to groups: In the figure at Group 1 (perimeter) are associated the first 3 partial.

- The groups are selected using the vertical arrow keys.
- RIGHT and LEFT arrows to select the partial, then press ENTER
- Enable it by pressing CANCEL when the cursor flashes
- Press CANCEL again to delete
- At the end, confirm with ENTER

G01/Prg 12345678
Perimeter □□□

PSTN MENU

the entire section of the public PSTN telephone network. It 'important to connect the control unit to a clean line. In case of lines with internet access is essential to use special filters upstream of the line. Any phones connected to the line must be connected to terminals T1 and T2 of the plant, in order to be released when it makes a call.

The following configuration parameters:

PSTN
Notification 0

This parameter enables or disables the notification of fault of PSTN line.

PSTN
Line Check 0

This parameter enables or disables the control of the presence of PSTN telephone line voltage.

PSTN
DialTone Check 0

This parameter check for dial tone; in case of absence the system doesn't dial.

If this parameter is enabled, in the absence of tone the system notice the event " TEL.LINE FAIL ".

If disabled, it always dial 2/3 seconds after it has taken the line.

PSTN
RingBack Check 0

This parameter enables or disables the tone control of sound free / busy after dialing the number. Once the panel compose the number hears this tone and, when it is interrupted by a response of digital receiver, it executes the set message (digital). When disabled, the control panel will not hear this tone and most waits for a response from the recipient or digital protocols.

PSTN
Ring Pause 4.5

This parameter modifies the break dial tone once done the call. This pause changes according to the standards adopted in different countries. In case of problems with the default setting 4.5sec. you can shorten or lengthen the pause to allow the panel to better understand the tone of free and the responses from users / receivers.

PSTN
DTMF amplitude 0

This parameter change the amplitude of DTMF signal, in case of noises of PSTN line, it is possible increase the amplitude of DTMF:

0 = normal signals amplitude

1 = double signals amplitude

PSTN
Compos.Waiting 0

This parameter is used when is disable the line control, the system take the line and wait few second before start the composition, the pause is used for allow the line to go in stable level. Normally when is active the control the system detect when can start the composition, when is disabled is important set a pause.

ARMING LOCK MENU

System activation is blocked by several situations that can compromise security. These situations are, in particular:

- no main power (no 230Vac)
- Low batteries in the control unit
- Anti-opening protection activated (tamper)
- manipulation protection activated (Tamper line)
- Tamper peripheral protection (radio, wired, ext.)
- Communication failed with one or more peripherals connected to the bus
- No GSM network
- interconnection fail (peripheral problems on th bus)
- wireless lost life test
- Fail of PSTN telephone line

These blocks can be momentarily disabled to perform tests or other operations.

Note: Installations without these blocks are to be considered not in compliance with E 50131-1 and EN 50131-3 certifications.

In the figures the parameters can be changed to stop the system arming block.

0 = unlocked

1 = locked

ARMING LOCK
No220V 1

ARMING LOCK
Battery 1

ARMING LOCK
Tamper 1

ARMING LOCK
Line Tamper 1

ARMING LOCK
Periph. Tamper 1

ARMING LOCK
NoGsm 1

ARMING LOCK
interconnection 1

ARMING LOCK
Wirel. Inactiv 1

ARMING LOCK
NoPstn 1

When is selected the timer, set the hour and selected the users and/or outputs and/or partials, you must set the base parameter, in other words, whether at that time they are activated or deactivated. In the figures to the side you can see the related screens:

Prg. 1234
Perimeter 01- -

[02] output two
- 1- - -

[01] User Nr 01
0 - - - - -

- 0 = deactivation/block of partial/user/output
- 1 = activation/unblock if partial/user/output
- = no association

fig 1, turning off of partial one and arming of partial 2 was programmed.

Fig 2, activation of output 2 was programmed

Fig 3, block of user 1 was programmed

TIMERS MENU: EXCLUSIONS

Once you have set the timers and created the weekly profiles, you can make it so the automatic action is suspended for a period of time (e.g., for vacations, holidays, etc.)

The exclusion periods have a start and end date.

The beginning starts at 00:01 and the end at 23:59:59.

Period 03
10/02 < - - > 25/02

In the figure you can see that exclusion period no. 3 was programmed. This period starts at 00:01 on 10/02 and ends at 23:59:59 on 25/02

TIMERS MENU: ENABLE EXCLUSIONS

After having set the exclusion period, it is activated by associating it to one or more timers.

The exclusion periods can be associated precisely to the individual timers (of the 8 available for each day of the week) Each timer can have more than one period of exclusion.

T01-Mon 12345678
□ . □

In the figure you can see that at timer no. 2 for Monday, 2 exclusion periods were associated, no. 1 and no. 3.

MENU USERS

The control unit has a total of 64 or 32 users, all of which can be freely associated to groups and partials. Each user can be programmed with specific privileges (detailed information on these privileges below)

MENU USERS: USER NAMES

The user names are programmed using the traditional method, entering the name by alphanumeric keys.

In the NAME menu, press ENTER, Using the Up and Down arrow keys, select the desired user, then press enter again

- Press CANCEL to delete the existing name

Enter the new NAME using the alphanumeric keys

Confirm with ENTER

MENU USERS: USERS TYPE

I = display only the system status: This function is simply for displaying the armed/disarmed status of the system on the keypad when not visible (setting tied to EN 50131)

R = change user code and program keys: This function generates a user that operates only with the system disarmed and changes all the user codes and programs keys.

M = master: This function generates the user with the maximum privileges: change user code, function, program and group link, read events, change date/time, program keys, delete keys, display input status, display residual credit, block timer.

U = user enabling and disabling: This is the standard user function, they can enable and disable associated programs, and modify their own code.

C = user for activate and deactivate outputs: This code is used for activate/deactivate all programmed outputs. It is possible use this code in all conditions (armed/disarmed)

H = holiday code: This code is used when you leave the protected area for a long time (eg. holiday) In this mode of arming, all entry/exit zone with delay time becomes immediatly.

P = panic code: this code is the same to U type code, but when be used the panel send a secret message of silent panic.

NOTE: for sending a panic silent message it is possible push in the same time G2 and G3 buttons

In the figure user 01 as MASTER. Use the alphanumeric keys to program the type.

[01] User Nr 01
M

MENU USERS: CODES AND LENGHT CODES

Is it possible to have user code with 6 or 4 characters, in menù code after last user, there is LENGHT parameter, select 4 or 6.

For modify codes select the number of user and then set the number with number buttons from keypad.

MENU USERS: PROGRAMS LINKING

It is possible to associate one or more partials and one or more groups to each user.

Therefore, the users have to possibility of arming and disarming only their assigned partials and groups.

In the figure, the user 01 has associated partials 1 and 3 and user 3

The groups are selected using the vertical arrow keys.

- Use the RIGHT and LEFT arrows to select the desired partial, then press ENTER

- Enable it by pressing CANCEL when the cursor flashes

- Press CANCEL again to delete

- At the end, confirm with ENTER

U01/Prg 1234
User Nr01 □ · □ ·

QUICK ARM USER

The user N° 32 is also utilized for configuration " Quick Arming " function. Therefore, when you activate this feature (from menu OTHER PARAMETR) , you must set the privileges on the users 32.

DATE/HOUR MENU

For change the date and time on the system using this menu

Once you have entered the menu, press ENTER to change

Press ENTER again to enter the day of the week (1 for Mon, 2 for Tue...0 for Sun)

Press the Right arrow to enter the day/month/year/hours/minutes in sequence

Confirm with ENTER

EVENTS MENU

The control unit saves each system operation and occurrence.

The system can save 1000 events with a rotating update system. Once the log capacity is full, the system will delete the oldest event to make space for new ones. In order to make reading easier, 2 systems were adopted:

- traditional reading: Traditional reading consists of entering the event menu and reading them.
- notification system: You can also group them by type of event to make searching and reading easier:

Fig1 Reading menu for all events



EVENTS MEMORY
All

fig 1

Fig 2 Reading menu for only unread events



EVENTS MEMORY
Unread

fig 2

Fig 3 Reading menu for only alarm events



EVENTS MEMORY
Alarms

fig 3

Fig 4 Reading menu for events connected to operating errors



EVENTS MEMORY
Anomalies

fig 4

Fig 5 Reading menu for system arming and disarming events



EVENTS MEMORY
Arming/Disarming

fig 5

Fig 6 Reading menu for user accesses



EVENTS MEMORY
Users

fig 6

The notification system is comprised of signalling individual alarms and errors from the control unit through the red LED using quick access. When the red LED on the keypad turns on, the control unit is notifying you that there is an event to read. Pressing the CANCEL key accesses the notification screen. In the figure, the system shows that there are 3 notifications to read. They can be read after inserting an enabled code.

Fig 1 the system shows 3 notifications



3 Events
[]

fig 1

Fig 2 When the code is entered, the system shows the notifications in chronological order. You can scroll through the log using the up arrow key.



16:35 - 27/02/13
lounge radar alarm

fig 2

Fig 3 When they have been read the red LED will turn off and the message in the figure will appear



<< NO NEW >>
<< EVENT >> #Exit

fig 3

SYSTEM RESET MENU

The parameter reset on the control unit can only be done with the installer code.

Resets are done in a specific menu and are divided into 3 categories:

- users codes menu reset
- configuration reset
- events memory reset (can only be done by the manufacturer)

IMPORTANT: if the installer code is lost, the control unit must return of producer.

Fig. 1 With this type of reset, all of the user codes and related parameters are deleted, except for the first one that is set to the default value (111111)



fig 1

Fig. 2 With this type of reset all of the control unit parameters are set to default except for the event log which cannot be deleted.



fig 2

Fig. 3 With this parameter you can reset the entire event log. Only the manufacturer can perform this operation for security reasons.



fig 3

EDIT VOCABLES MENU

With this menu it is possible to change some word of vocabulary for the name of zone, output, ext.

In the K series, where is not audio support it is possible change all words:

- select **vocables list from** EDIT VOCABLES menu
- select the number or the vocables that is be changed (for K all, for X first 30 words)
- press ENTER and use the alphanumeric keypad for modify

In X series where there is pre record vocabulary, there is the possibility to add 30 recordable words to the vocabulary:

- select **vocables list from** EDIT VOCABLES menu
- select the number or the vocables that is be changed
- press ENTER and use the alphanumeric keypad for modify
- select audio messages
- the number of place from 1 to 30
- press * to play and select X to record new audio.

MENU PRIORITY VECTOR

With this menu it is possible select the sequence of vector priority for sending message to the monitoring station and to the user.

The vector are:

- PSTN
- GSM
- LAN
- GPRS



For set the sequence, set the vector in numbering order, from 1 to 4, with vertical arrow select the number of order, with buttons 1 - 2 - 3 - 4 select the vector.



ADEMCO MENU

The control unit is set to send digital protocols ademco 4+2 and CONTACT ID. The system can be freely configured for each input zone and each type of event. You can have up to 8 telephone numbers with 8 different system IDs that can send data to various reception control units. It is possible to send contact ID data via PSTN, GSM, GPRS, LAN.

CID EVENTS

With this parameter you can display and change all of the codes related to all of the events available in the control unit.

SIREN 320	WIR.DEV.LOW BAT. 384	TECNO INPUT 150
ZONE TAMPER 137	WIREL.NO SUPER. 381	EVENT LOG RESET 621
NO 220V 301	WIRELESS TAMPER 383	GENERAL RESET 313
LOW BATTERY 309	PERIPH.TAMPER 341	PHONE LINE 352
NO GSM LINE 351	PROG.MODE ENTRY 627	MASKING 138
SYSTEM ON/OFF 401	SYSTEM RESTART 305	CONNECT FAILURE 143
REMOTE ON/OFF 407	WRONG CODE 461	INPUT FAILURE 144
ON/OFF BY TIMER 403	ZONES EXCLUSION 570	AMRMING FAILED 453
LIFE TEST 602	COERCION 121	[01] zone 1 130
RF NOISE 344	ZONE PANIC 120	[64] zone 64 130

In the figure, the list of events that can be transmitted in CID, the event code number including the brackets and the standard ones used by the protocol. It is freely changed all of the event codes for any zone input and any type of event available. Select the desired event and confirm with SEND. The number flashes and so can be changed.

ENABLE CID

It is possible enable or disable the single events of sending.



event disabled



event enabled

For enabled/disabled events, press ENTER in the single event and modify by pressing CANCEL

ADEMCO PHONE NUMBER

Set the number for CMS, select the prefix where is requested, and select the type of message that will be sent.

TEL.number [01]
00033445856456

PREFIX TEL [01]
Pstn () GSM ()

encoding TEL [01]
Contact ID

RESPONSE WAIT

This is the amount of the time the system waits for a response during a call before going on to the next one. It can be set from 1 to 50 seconds.

ADEMCO NETWORK PARAMETERS

When the event is enabled, there are the network settings:

IP/domain [01] 192.168.1.1	IP address of monitoring station receiver n°1
IP/domain [02] 192.168.1.1	IP address of monitoring station receiver n°2
Port num. [01] 10000	Port number of first IP number
Port num. [02] 10001	Port number of second IP number
Protocol [01] Tcp/Udp	Protocol type TCP or UDP
Protocol [02] Tcp/Udp	Protocol type TCP or UDP
Encoding dc09 CID	Type of encoding: - select 0 for set: IT GPRS RX - select 1 for set: DC09 CID - select 2 for set: DC09 SIA IT gprs RX is a proprietary protocol, and needs the HW receiver in monitoring station. DC09 CID and SIA is a standard IP protocol.
Data session (sec.) 60	This parameter mean that the max time for sending/contact the receiver, is needed for close the communication in case of error from receiver.
Phone SMS Backup	this is a special number that is used in IT GPRS RX for IP backup, in case of fault communication via IP, the system will send the SMS.

ADEMCO NETWORK MONITOR

The monitor, is a special signal that is used for life test of the IP connection between the monitoring station.

This signal can be sent directly on special database soft, or in IT GPRS RX.

IP/domain 192.168.1.1	IP address of monitoring station receiver
Port Number 8000	Port number of receiver
ID monitor 12345678	Number of identification system
time monitor 1 min	Time between signals

ADEMCO SYSTEM ID

For each partition it is possible set a ID number:

ID prg. 01 1234	ID prg. 08 7788
----------------------------------	----------------------------------

4+2 EVENTS

With this parameter it is possible view and modify all the codes for all available events with Protocol 4 +2. When you see the value " ?? " it means that you have not yet entered any code for the selected event. The procedure to enter the codes is as follows:

- Select the desired event (ex: zone alarm)
- Select the zone number (ex: zone 5)
- Once selected the event and the number, by pressing the ENTER key the blinking cursor moves on the 2 numbers at the bottom. (?? or 00)
- At this point you can set the hexadecimal code to be sent to the receiver.

ZONE ALARM 05
5A

Below is the list of the events default programmed:

ARM.BY USER [10] 01	DISAR.BY USER [20] 01	ZONE ALARM [30] 01	ZONE RECOVERY [40] 01
ZONE BYPASS [50] 01	AC MISSING [60]	AC RECOVERY [61]	LOW BATTERY [62]
RECOVERY BATTERY [63]	TAMPER [64]	TAMPER RECOVERY [65]	REMOTE ARMING [66]
REMOTE DISARMING [67]	ROBBERY [68]	CALL TEST [00]	ARMED BY PRS [70]
DISARMED BY PRS [80]	FAILED ARM [90]	PANIC [A0]	PANIC RECOVERY [B0]

ADEMCO - MAX ATTEMPTS

With this parameter it is possible establish the number of call attempts that the system must perform before notify the error in the event of no CID notification. In this case the attempt performance is not by rotation, but all of the attempts set will be made to the same number. In the event of failed notification, the system will move on to the next number (programmed from 1 to 10)
Important: every failed attempted is shown in the event log.

ADEMCO - ZONES RECOVERY

The use of this function activates the real time report for the activity in the individual zone during an alarm cycle. By activating it you can determine when the intruders leave the protected area.

0 = deactivated

1 = activated

Note: The reset activity is managed by the alarm cycled determined by the siren time. Therefore the shorter the siren time, the closer the notification of the resets.

ADEMCO - DELAY RECOVERY

With this parameter is possible to have the recovery zones after siren time:

0 = deactivated

1 = activated

TEST MENU

The control unit is equipped with a test tool to be able to verify that the system is operating properly.

The tests that can be performed are:

- siren
- inputs
- outputs
- Contact ID call

In the fig. you can see the screens for performing the siren test. Once you have entered the menu, use the ENTER key to activate and deactivate the siren test

The zones test is performed by counting down the breached areas. In the example in the figure there are still 34 inputs to test. Each time an input is unbalanced, the system decreases the counter and activates the keypad buzzer. The test can be interrupted at any time by pressing ENTER. This system allows you to test all the inputs without any staff. Only one person is needed.

The output test calls for the selection of the desired output and activation of it for 5 seconds.

The figure shows the test screen. Use the ENTER key to activate the output.

voice call test:

For the test, the call will be made to telephone number no.1, communicating the life test event. The call is activated by pressing ENTER and waiting for it to arrive. In case the voice module is not plugged the system will send bip sounds.

Ademco protocol test:

For the test, the call will be made to telephone number no.1, communicating the life test event. The call is activated by pressing ENTER and waiting for it to arrive. The event that is sent is always the life test(event no. 602) for CID and 4+2.

TEST
Siren

SIREN TEST
Activate ??

SIREN TEST
Disactivate ??

ZONES TEST
Tot:34 **V-stop**

TEST OUTPUTS
Tot:17 **V-start**

01-output 1
Activate ??

01-output 1
Activated (4.3.2...)

TEST
voicecall PSTN/GSM

TEST
ContactID PSTN/GSM

TEST
Ademco4+2 PSTN/GSM

This section regarding the test via IP (LAN and or GPRS)
It is possible test the DC09 standard with CID

TEST
ContactID GPRS/LAN

This section regarding the test of SIA FSK protocol, this test is made
via PSTN phone line

TEST
SIA FSK PSTN

This section regarding the test of SIA IP protocol with DC09 encoding.
It's possible test the GPRS and LAN module for sending.

TEST
SIA IP GPRS/LAN

This section regarding the test of Ademco 4+2 protocol via PSTN
and GSM with DTMF.

TEST
ademco4+2 PSTN/GSM

MENU NETWORK

LAN PARAMETER

With this parameter it is possible to set IP address for IP Board:

First enable IP board from peripheric menu.

select DHCP to 1 for automatic setting, wait few minutes after exit from menu. In case doesn't work:

- set 0 and set static IP and other parameter of network

IP address: eg. 192.168.000.008

Subnet mask: 255.255.255.000

Gateway: 192.168.001.001

DNS1: 008.008.008.008

DNS2: 208.067.000.000

For complete all parameter it is important to know the network parameters where the IP is connected.

Set the free static address for ip board, complete all parameters.

Exit from menu and wait few minutes. When the IP is connected must be see:

green led = steady (IP enable on peripheric)

orange led = blink machine running (when the led is steady or in OFF the machine nor run)

1° red led = off cloud connected (turn ON disconnected)

2° red led = off internet connected (turn ON disconnected)

little red = lan speed (OFF=10 ON = 100MB)

NOTE: when the system is in DHCP is important to know that the router assign IP to the machine (in some case is necessary wait few minutes, or set the roueter to do this).

CLOUD PARAMETERS

DON'T MODIFY THIS FIELD this is the cloud address

ACCOUNT

In this menu are all parameter that used for registration to the cloud. (for APP)

Enable Cloud service: this parameter is important, because is the activation of 30" ping on Cloud, for maintain the system always connected to the Cloud. **The transmission on Cloud is in SSL4 cripted**

username: it used for name ID, the same name must be inserted to the APP during to the registration panel

password: password, the same password must be inserted to the APP during to the registration panel

UID CODE: this code is most important because is the unique identification code of panel. Must be inserted to the APP with all number and characters **IDENTICAL.**

NOTE: it is possible have the same password and username with different UID in the same APP (main house, beach house etc.)

CLOUD NOTIFIC.

With this parameter it is possible to enable and disable smart notification in phone APP when it closed.

ALARM: when the system trig in alarm it is possible receive notification on smartphone (even when the application is closed)

USERS: when is enabled every action by all user are sent by notification APP (even when the application is closed)

ARMING: When is enabled every arm and disarm for each program are sent by notification (even when the application is closed)

For enable notification turn from 0 to 1 every single voice:

eg. **ALARM = 1 (ENABLED) ALARM=0 (DISABLED)**

GPRS PARAMETER

In this section there are all parameters for enable the GPRS system for cloud APP and for sending CMS messages:

Enable GPRS: this parameter enable the module GPRS to work, when is disabled the system work only in GSM mode.

Access point APN: set the name of access point

User name APN: some provider needs the name and password, in this section set the name

User password APN: some provider needs the name and password, in this section set the password

MENU OTHER PARAMETERS OTHER PARAMETERS: SIREN SETTINGS

SIREN SETTINGS: SIREN DURATION

This parameter sets the duration time of the siren sound in the event of an alarm.

To set the new value press ENTER to confirm. Can be set (from 0 to 240 sec) press CANCEL to delete the current value

Note: setting 0, the "siren" commands are not activated.

SIREN SETTINGS: SIREN PAUSE

This parameter sets the pause time between one activation and the next in the event of a persistent alarm.

To set the new value press ENTER to confirm. Can be set (from 0 to 240 sec) press CANCEL to delete the current value

Note: by setting 0, there will no longer be a pause between one activation and the next.

SIREN SETTINGS: SIREN CYCLES

Siren cycle means the maximum number of siren activations in one 24 hour day (from 00:00 to 23:59).

Ex., 5 cycles of 1 minute means that the siren can ring for 1 minute for a maximum of 5 times in one day. Once the limit assigned in the case of alarm has been reached, the siren will no longer ring. This stop will be reset at 23:59:59.

To set the new value press ENTER to confirm. Can be set (from 0 to 32 sec) press CANCEL to delete the current value

Note: enter the value 0 to not have ring limits

SIREN SETTINGS: SIREN TO KEYPAD

With this parameter it possible set the keypad for repetition of alarm siren with internal buzzer.

Set 1 for enable, set 0 to disable

SIREN SETTINGS: SQUAWK FUNCTION

With this parameter it is possible to have a signal from siren when the system is armed and disarmed.

For wireless sirens it is possible have another info, the memory alarm.

there are 2 menu parameters, 1 for wired sirens, and another for wireless sirens:

WIRED SIREN:

SQUAWK
Duration (sec.) 0.0

WIRELESS SIREN:

SQUAWK
Arm/disarm visual 0

notification with light of arm disarm, switch to 1 for enable.:

SQUAWK
Arm/disarm sound 0

notification with sound of arm disarm, switch to 1 for enable.:

SQUAWK
Alarm memory 0

alarm notification when disarm panel, the siren will notify with a low power sound and lamp flashing switch to 1 for enable.:

OTHER PARAMETERS: TAMPER SETTINGS

TAMPER SETTINGS: SYSTEM TAMPER

This parameter enables or disables the anti-opening protection.

Press ENTER to set the value (0=disabled, 1=enabled) Confirm with ENTER

TAMPER SETTINGS: TAMPER AP

This parameter enables or disables the AP tamper protection on the control unit line (see fig. and board description).

Press ENTER to set the value (0=disabled, 1=enabled) Confirm with ENTER

TAMPER SETTINGS: TAMPER AP TYPE

This parameter determines the type of AP tamper on the control unit line (see fig. and board description).

Press ENTER to set the value (CANC = NC; 1=balancing 1k) Confirm with ENTER

TAMPER SETTINGS: TAMPER PERIPHERALS

This parameter enables or disables the anti-sabotage protection of the entire bus 485 line, therefore if it is left disabled, any tampering from the peripherals will not be reported. Press ENTER to set the value (0=disabled, 1=enabled) Confirm with ENTER

OTHER PARAMETERS: DIALER SETTINGS (ONLY X SERIES)

DIALER SETTINGS: RING NUMBER

This parameter set the ring number during in the incoming calls. It use to manage system with audio support.

Press ENTER to set the value. Confirm with ENTER

DIALER SETTINGS: EVENT DELAY

This parameter set the time between 2 same events for to be logged in memory events and for calls and SMS.

Eg. if there is 10 times same events of manipulation, it is possible put a pause between of 10 sec. in this way you avoid numerous reports and calls for the same event. Press ENTER to set the value. Confirm with ENTER

OTHER PARAMETERS: SPEAKERPHONE (ONLY X SERIES)

With this parameter it is possible enable voice support in keypad, for this is necessary to use **K-VOICE model** and use only panel X series with audio integrated on board. It is possible listen ARM/DISARM system, ALARMS, OPEN ZONES.

Press ENTER and press 1 to enable press 0 to disable.

OTHER PARAMETERS: RADIO SETTINGS

RADIO SETTINGS: LEARN (433MHZ ONLY)

This parameter determines the learning mode for the radio devices. By default, the key used for device learning is the LEARN key. If you wish to use any other device radio transmission to memorize it, set this parameter to 1. Press ENTER to change the value and enter 0. **default: 0 = Learn key**

Note: by using the learn key to program the radio devices you are sure that there are no radio data readings coming from devices that are not to be programmed.

RADIO SETTINGS: SATURATION

This parameter enables the radio saturation notification. Saturation is the complete obscuring of communication between the devices and receivers. The notification and subsequent system alarm is activated after 2 minutes of total radio obscuring.

Press ENTER to set the value (0=disabled, 1=enabled) Confirm with ENTER

RADIO SETTINGS: RADIO NOISE (433MHZ ONLY)

This parameter enables the notification of radio disturbances. The notification is activated when there is a reception of a potentially dangerous radio signal for more than 5 seconds. Press ENTER to set the value (0=disabled, 1=enabled) Confirm with ENTER

OTHER PARAMETERS: EN50131 SETTINGS

EN50131 SETTINGS: ENABLE 50131

This parameter is an automatic configurator for the set up of the control unit in order to be in compliance with EN 50131 - 1 and EN 50131 - 3. When the function is activated the following parameters are changed:

- input and output times set to 45" (only if set higher)
- all inputs configured as double balancing
- masking of the display of the system status. The system status will only appear in the first 30" after arming and disarming.
- activation of all arming blocks for conditions other than the standard ones (open zones, errors, tampers, etc.)

Press ENTER to set the value (0=disabled, 1=enabled) Confirm with ENTER

EN50131 SETTINGS: VISUAL.STATUS

This parameter enable the masking from the display of the system status. The system status will only appear in the first 30" after arming and disarming. Press ENTER to set the value (0=disabled, 1=enabled) Confirm with ENTER

EN50131 SETTINGS: VISUAL.ZONES

This parameter activates the masking of the not ready zones in LCD. In normal mode when there are zones not ready and/or troubles, the LCD displays such zones/troubles. Press ENTER to set the value (0=disabled, 1=enabled) Confirm with ENTER

EN50131 SETTINGS: NO 220 (MIN)

This parameter is the time that elapses between the no power notification, which is instantaneous, and the remote communication through the GSM communicator (SMS, CID). Press ENTER and set the value (value can be set from 0 to 240 sec.) Confirm with ENTER

default: 0 seconds, immediate call

EN50131 SETTINGS: CHARGE BATTERY

This parameter is a regulator of current charge for battery. In default the current of charge is 300mA. It is possible increase the current to 450mA. Press enter and use the CANCEL key for increase.

Other Parameter
Battery charge □ -
300mA setup

Other Parameter
Battery charge □ □
450mA setup

EN50131 SETTINGS EN 50131: SELF-EXCLUSION

It determines the maximum number of consecutive alarms/tampers for zone after which the system will automatically disable it for that single Arming/Disarming. (after disarm the exclusion reset)

Press CANCEL to delete the current value. Set the new value and press ENTER to confirm. It can be set (from 1 to 10) Default = 5

OTHER PARAMETERS: LIFE TEST

This parameter indicates after how many hours the system must regularly inform the user that the life test result is successful and that therefore the system system works properly. (the value to be inserted is expressed in hours)

Press ENTER, press CANCEL to delete the current value. Set the new value and press ENTER to confirm. Can be set from 0 to 240.

Note: the default value is 0 = disabled

It is possible set the hour of start the life test.

eg. every 24hours at 04:00 AM

OTHER PARAMETERS: QUICK ARMING

With this parameter the control unit can be armed without using your personal code. The settings of " Quick Arming " function are related to the last user available (32th) for link the partition and groups.

Press ENTER and press 1 to enable press 0 to disable **(is important to ready programmed linking programs on user 32)**

OTHER PARAMETERS: MAINTENANCE

With this parameter put the control unit in maintenance mode. This condition means the system, even in the presence of alarms, tampers, errors, etc., does not activate the siren or remote communications.

When the control unit is in maintenance mode it will show on the display.

Press ENTER set 1 to enable or 0 to disable

*** MAINTENANCE! ***
14:30:15

PROGRAMMING PANEL WITH SOFTWARE

It is possible program the panel via software, DBexplorer.

There 2 mode for programming: local and remote via cloud system.

Local programming:

- adapter connector COM/USB
- driver for COM/USB
- a cable USB to mini USB standard
- DBexplorer Software

Set the telemanagement code (default is 7777777) **via keypad** go to user code, in installer editor(default code 000000) and set **telemang. code**, the same code must be set in the soft, in the tab of user infomartions.

Enable the panel for soft programming, via keypad go to user menu (default 111111) set the menu **enable telemang.** and set **1**.

Open the soft **db explorer** and set the parameter of comunication serial port.

Now it is possible change, send and get all setting from or to the panel.

remote programming, via cloud service:

- Panel must be connected to the cloud with IP board and/or GPRS module

Set the telemanagement code (default is 7777777) **via keypad** go to user code, in installer editor(default code 000000) and set **telemang. code**, the same code must be set in the soft, in the tab of user infomartions.

Enable the panel for **remote soft programming**, via keypad go to user menu (default 111111) set the menu **enable telemang.** and set **2 remote cloud programming**.

IMPORTANT: when is enabled the remote programming, set 2, the APP will be inactive for all time that this option is on 2 mode.

Open the soft **db explorer** and set the parameter of comunication remote programming, and Put the **UID CODE** in the space tab.

note: the UID CODE must be copied from installer editor in the **NETWORK MENU --> CLOUD ACCOUNT**.

Now it is possible change, send and get all setting from or to the panel.

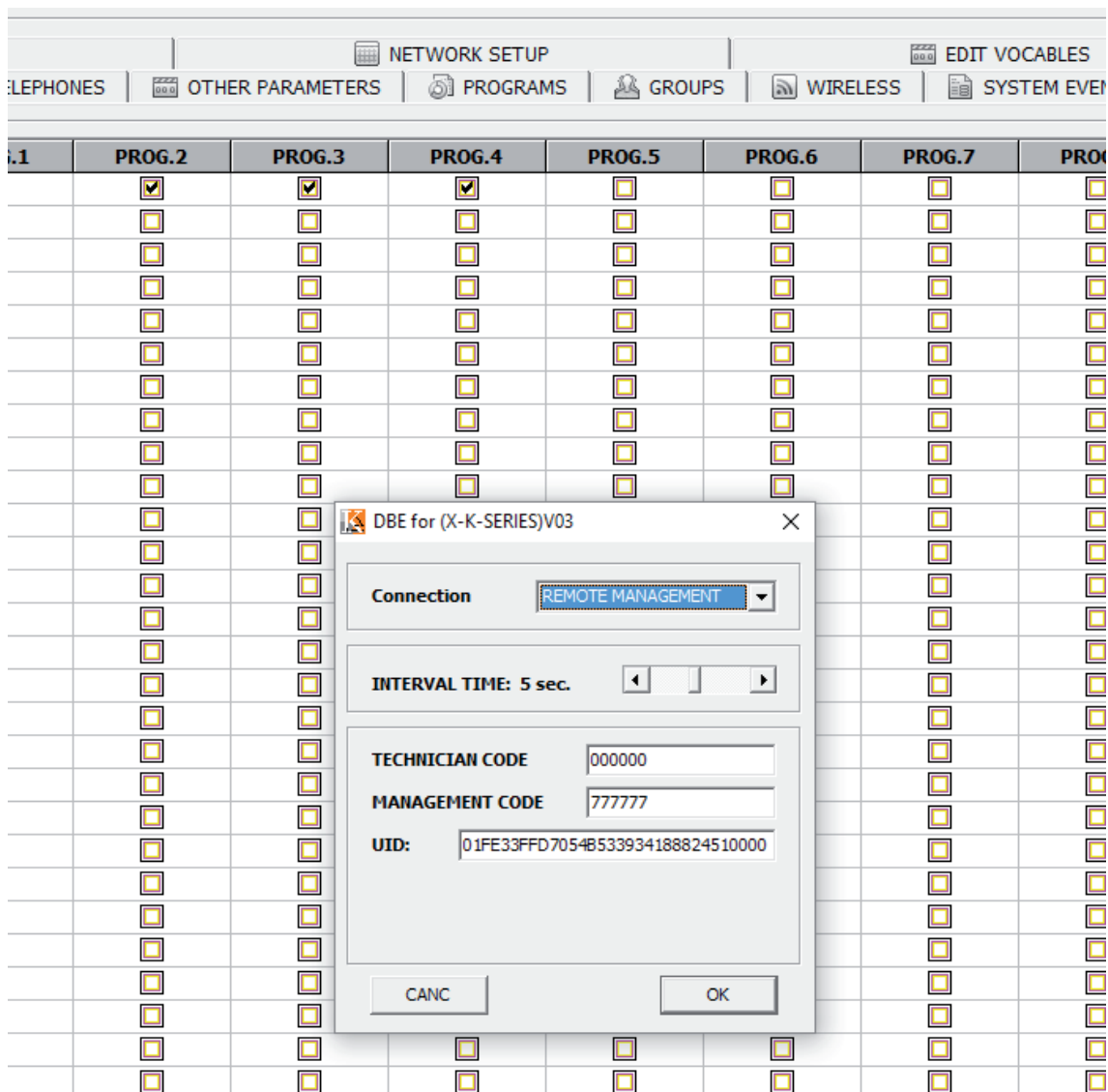

AMC AMANAGER APP

AMC MANAGER is an application for smrtphone that allow the user to manage many parameters of panel:

- arm and disarm all partitions of panel
- bypass all programmed zones
- turn ON and OFF all programmed output
- monitoring system status
 - back up battery
 - main power
 - all type of Tamper
 - gsm signal
 - PSTN line status
 - peripheral status
 - connection cables
 - wireless trouble
- Log events



REGISTER APP

After download APP is necessary to register it.

The screenshot shows a mobile application interface for registration. At the top, there are status icons for signal strength, network (vodafone IT), time (11:25), and battery (100%). Below the status bar, there are two links: 'Register' and 'Login'. The main form consists of two input fields: 'E-mail' and 'Password'. Below these fields is a large, empty rounded rectangular box. Underneath that is a toggle switch for 'automatic login', which is currently turned off. At the bottom of the screen, the AMC logo is displayed with the tagline 'YOUR SECURITY CHOICE'.

Complete all field:

EMAIL: that you can receive directly to the mobile

Password: create a password for register

After these operations press login and wait email from Cloud AMC.

The cloud will send a mail with:

- 1 code that be set in the app for finish the registering operation or
- 1 button CONFIRM with the link for the direct confirm without code (important: the link must be open directly with APP)

Important: if don't receive mail check in junk mail, if don't work the confirmation button use code.

Important with Android: when you push confirm button must be open the APP, if this do not happen, go in application management, find browser application and delete default preference.

ADD PANEL TO THE APP

In this section it is possible enter the panels.

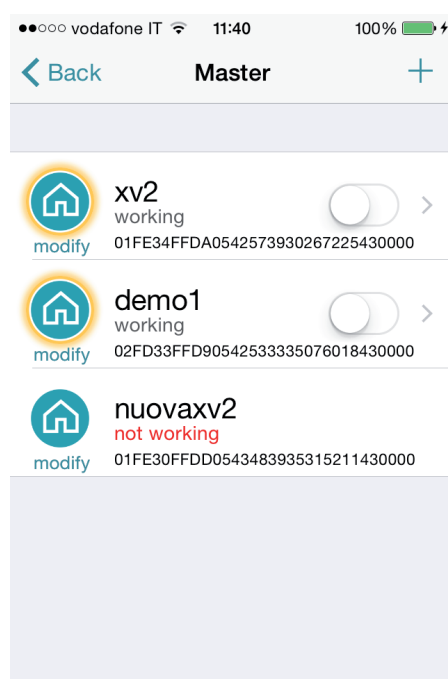
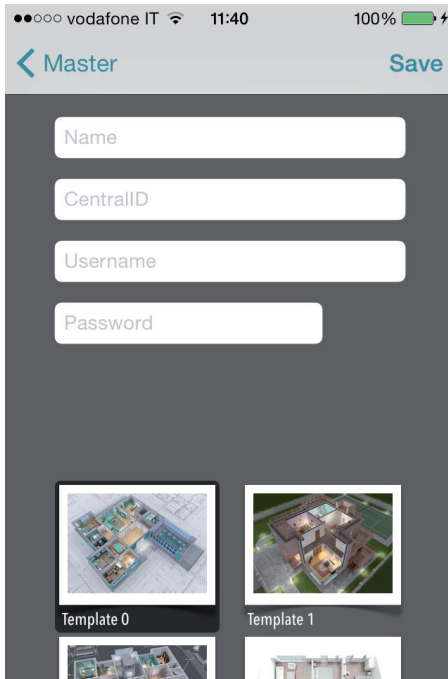

Name of installation ex. **main Home**.

ID: is the **UID CODE** that you found in the menu **CLOUD ACCOUNT** in the panel

USERNAME and PASSWORS: are be the same that is set in **CLOUD ACCOUNT** menu in the panel

It is possible select a template for map, or use a custom image, or take a photo from internal camera of smartphone. After this it is possible to manage panel (in pic it is possible to see 3 panel in the same APP)

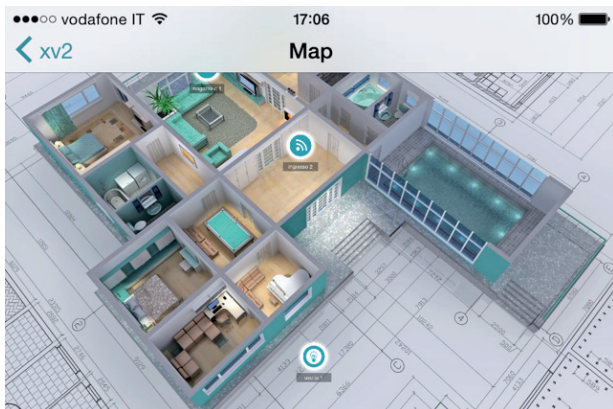

In figure it is possible to see the map when the phone is in land screen (horizontal). It is possible to add and set in right position the zone and the output. Select the photo for each zone and outs.

The app show when the zone is:

ready: green circle

open: orange circle

alarm: red circle

it is possible check and move programmed outs.



TROUBLES AND STATUS INFO

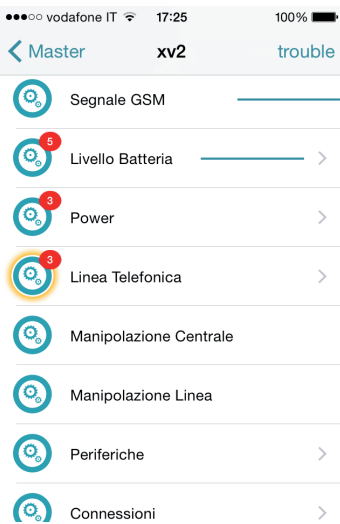

In figure it is possible to see the status of panel:

- back up battery
- main power
- all type of Tamper
- gsm signal
- PSTN line status
- peripheral status
- connection cables
- wireless trouble

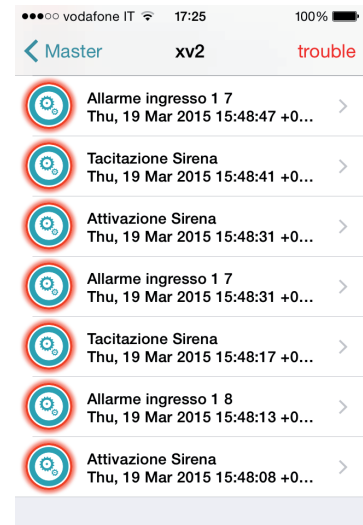
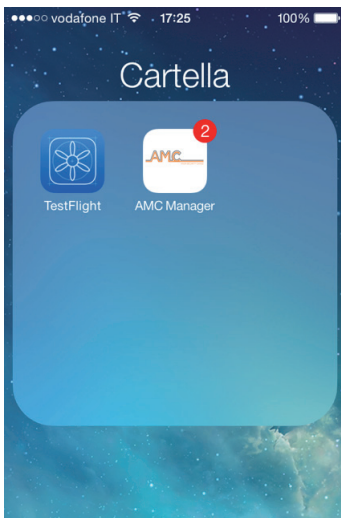

In case of alarm it is possible receive notification with push technology (save battery life) In figure it is possible to see events and notification.

HOW TO USE THE SYSTEM (USER MANUAL)

ARM/DISARM PARTIALS AND GORUP

When the system is disarmed, digit personal code (default 111111).
The screen that appear will be the program and/or group that is linked to the code, **AFTER 3 SEC. START THE COUNTDOWN OF ARMING.**

Before starting time exit (3 sec.) it is possible change the program and/or group by using the number keys and G keys. Figure 2 shows the activation of partial 1, the line above shows the name and the line below shows which partial was selected.

Fig. 3 shows the activation of Group (1 and 2). By using G key.
After selection in 3 sec. will start again time exit.

fig1

Total
1234

fig2

program 1
1 - - - - -

fig3

perimetric
1 2 - - - - -

Note: partial selection is step-by-step so pressing the number of the partial more than once turns it off and back on.

ARM/DISARM GROUPS BY QUICK ARM

Each group can be given a name and be associated with the desired partials.

Once programmed, activation is done in the same manner as the partials (see below ... ARM and DISARM)

with G keys it is possible set the quick ARM (arming without code, 1 touch). For set quick code, go in other parameters, menu QUICK ARM and enable (switch to 1). For modify the Group (G 1-2-3-4) that be start without code, set the user 32 or 64 of panel, this user is used for set the quick code. **After settings when one of G is pressed will start the arming Group (G).**

For change the group before starting press anothe G keys in 3 seconds before starting time exit.

G1 **G2** **G3** **G4**

fig2

PERIMETER
- 2 3 4 - - - -

In the figure, the group called "PERIMETER" is made up of 3 partials (2-3-4)

Note: When is active the option **EN 50131** is not possible arm the panel when there are the following troubles:

no main power, battery low, tamper, line tamper, peripheral tamper, no gsm, no lan, interconnection between devices, wireless fault wake up.

BYPASS ZONE

There are 2 different way of bypass: **EXCLUSION and INHIBITION.**

EXCLUSION (**P**) = Permanent mode, the zone will remain bypassed always. For unbypass you need go in specify menu

INHIBITION (**T**) = Temporary mode, the zone will remain bypassed only for actual arm, after disarming the zone will return ready.

NO BYPASS (**■**) = No bypass, the zone is ready

NO BYPASS (**□**) = No bypass, the zone not ready

Bypass with not ready zones: during in the arming procedure the system show the message zones not ready, and invite to select the buttons for check,bypass, include (1 = include, 2 = inhibition, 3 = check) when is pressed 3, the system will show the menu of bypass (fig)

BYPASS ZONES
V-Select

[01] Zone 01
P T

press ENTER for go in menu zone bypass, press X key for choose between **P T**

Bypass with system ready (all zone closed): during in the arming procedure, immediately after selected partitions, press X button to go in the bypass menu, the procedure is the same.

When the system is armed with bypassed zones, the type is armed will be **FORCED** in event log it is possible to see witch zone is bypassed and in witch way.

NOTIFICATIONS (QUICK VIEW OF LAST EVENTS)

The notification system is a quick view of last events from the control panel. When the red LED on the keypad turns on, the control unit is notifying that there are events to read. Pressing the CANCEL key accesses the notification screen. In the figure, the system shows that there are 3 notifications to read. They can be read after inserting an enabled code.

Fig 1 the system shows 3 notifications



3 Events
[]

fig 1

Fig 2 When the code is entered, the system shows the notifications in chronological order. You can scroll through the log using the up arrow key.



16:35 - 27/02/13
lounge radar alarm

fig 2

Fig 3 When they have been read the red LED will turn off and the message in the figure will appear



<< NO NEW >>
<< EVENT >> #Exit

fig 3

EVENTS MENU

The system save 1000 events with rotating update system. Once the log capacity is full, the system will delete the oldest event to make space for new ones. Is it possible read the event log sort by type.

For enter in menu event, insert code select MENU EVENT with vertical arrow, press enter and choose.



EVENTS MEMORY
All

Fig1 Reading menu for all events



EVENTS MEMORY
Unread

Fig 2 Reading menu for only unread events



EVENTS MEMORY
Alarms

Fig 3 Reading menu for only alarm events



EVENTS MEMORY
Anomalies

Fig 4 Reading menu for events connected to operating errors



EVENTS MEMORY
Arming/Disarming

Fig 5 Reading menu for system arming and disarming events



EVENTS MEMORY
Users

Fig 6 Reading menu for user accesses

SYSTEM INFO

The control panel has a quick menu to access to basic information. When panel is disarmed if is pressed X, after code it is possible view these info system, every X pression give more info:

- quick event log menu
- PSTN status
- GSM status
- Battery status
- Main Power status
- IP board Internet status
- GPRS board Internet status
- Cloud connection status
- Firmware version
- Hardware status

ENABLE INSTALLER ACCESS

The rules of EN standards require that a **user level 3** need permission of **user level 2** for enter in programming menu panel. This parameter is ENABLE INSTALLER ACCESS. When this parameter is set to 1, the installer can enter in programming menu. Use personal code (level 2) and with down arrow go to parameter ENABLE INSTALLER ACCESS, Press enter and set 1 to allow. (0=not allowed)

ENABLE REMOTE MANAGEMENT

For programming panel with software PC, is necessary enable the system.

There are 2 ways for programming panel:

1 = local programming with usb cable and adapter socket

2 = remote internet programming via cloud

Use personal code (level 2) and with down arrow go to parameter ENABLE TELEMANAGEMENT, Press enter and set:

0 = FOR DISABLE PROGRAMMING SOFTWARE (ONLY KEYPAD)

1 = LOCAL PROGRAMMING SOFTWARE

2 = REMOTE INTERNET PROGRAMMING VIA CLOUD (when this option is enabled, the app no working)

**ENABLE
TELEMANAGEMENT**

**TELEMANAGEMENT
Enabled 1**

CHANGE CODE MENU

Every user (level 2) can change its own code.

Use personal code (level 2) and with down arrow go to parameter CHANGE PERSONAL CODE, Press enter and set new code.

Is important set another code, with same length of characters, in case of error system do not permit to save new code.

Note: with MASTER code (particular level code) it is possible modify all user level 2 codes.

**CHANGE
PERSONAL CODE**

**CODE: User Nr 01
111111**

DATE/TIME MENU

Set the date and time on this menu

Enter the menu, press ENTER to change

Press ENTER again to enter the day of the week (1 for Mon, 2 for Tue...0 for sun)

Press the Right arrow to enter the day/month/year/hours/minutes in sequence **Confirm with ENTER**

ACTIVATE PROGRAMMED OUTPUTS

The control unit has a system with a synoptics panel for quick activation of the outputs associated to a user code. Once entered in the output activation menu, press ENTER and go to the associated outputs. Use the vertical arrow keys to activate and deactivate.

The figures to the side show the output activation screens. The outputs that can be activated are only those showing 0=deactivated and 1=activated.

All outputs marked with a dash cannot be activated because they are programmed with other functions.

Once you have entered the activation menu, use the horizontal arrow keys to move from one output to the other and the vertical arrow keys to activate or deactivate

(up arrow = activate, down arrow = deactivate)

**ACTIVATE
OUTPUTS**

**[05] name output 05
0 - - - 0 - - - - - - - - -**

**[05] name output 05
0 - - - 1 - - - - - - - - -**

SHORTCUT

The system has quick keys (SHORTCUT) with which to active some signals and outs.

Panic shortcut: panel has 2 type, **silent with G2 and G3**, press in the same time for 2 seconds, **siren with G1 and G4**.

Activation outputs shortcut: it is possible program and link the outs direct to the number button of keypad, when this button is press and hold for few seconds, the outs turn status and display show the operation.



**garden light
activate**



**garden light
deactivate**

MENU TIMER

The panel has a system timer, for arm and disarm, for enable and disable outs, for enable and disable users.

During the autoarming will start a extra time of 1 minutes, after this time will start the exit time.

During in exit time is possible stop the autoarming by insert code level 2.

It is possible set the timer for auto arming in a sequence of arming with sequential hour:

For example:

- first try to arm at 8:00
- second try to arm at 9:00
- third try to arm at 10:0

In this way if the user stop the first sequence by code, the panel will try with second try to arm after 1 hour.

In autorming mode, the panel will arm only if all condition are ok:

- All zone ready
- No error or fault

In case of zones not ready, and/or some Tamper or fault, the system will not arm, and the same time will send the notification of fail arm.

With autoarming is not possible bypass zone.

The user level 2 can stop all operation by timer:

- Enter code level 2
- with vertical arrows go to menu timer
- press enter for modify parameter: (0 = timer disabled, 1 = timer enabled)

When the timer is set on 0, all operation are stopped.

PROGRAMMING AND CANCELLING KEYS

The Master user can program the key of tag reader for all user:

Selected the PROGRAMMING KEYS menu, confirm with ENTER, select the user by using the vertical arrow keys, send the learning command by pressing ENTER, 15" countdown will start during which the LEDs on the READER will flash and the user must place a key close to the READER when the code is learned, the led stop, and in keypad displayed succesfull.

PROGRAM KEY
User Nr 01

Insert Key
by 15 sec.

Cancellation is done in exactly the same manner as programming. Once the user to be cancelled is selected, press ENTER to confirm cancellation.

CREDIT MANAGEMENT

In this menu is it possible enter the parameters for sending the credit request SMS.

A specific menu "TEL. provider" and "SMS provider" can be used to enter data for Other Mobile Phone Providers.

For Check the correct value of SIM credit, is important that the KEYWORD be entered. The keyword is a word immediately before number of credit value, in the SMS sent by provider. The Credit value is always updated each time the control unit performs a data CMS call or sends an sms. The message received from the provider containing the credit value will be shown directly on the display. Credit threshold is the minimum level credit before send the info. (default is 3€ or other currency)

MENU NETWORK

ACCOUNT CLOUD

In this menu are all parameter that used for registartion to the cloud. (for APP)

username: it used for name ID, the same name must be inserted to the APP during to the registration panel

password: password, the same password must be inserted to the APP during to the registration panel

UID CODE: this code is most important because is the unique identification code of panel. Must be inserted to the APP with all number and characters **IDENTICAL.**

NOTE: it is possible have the same password and username with different UID in the same APP (main house, beach house etc.)

enable cloud: the cloud service must be enabled for have APP and push in real time, the cloud is used for remote programming too.

system name: is only the name of panel, in 1 app it is possible program more panels with different name

TEST MENU

The control unit is equipped with a test tool for check if the system work properly.

The tests that can be performed are: - sirens - inputs - outputs - voice call - CMS call - ETC.

In the fig. it screens the siren test. ENTER key to activate and deactivate the siren test

TEST
Siren

SIREN TEST
Activate ??

SIREN TEST
Disactivate ??

The zones test is performed by counting down programming zones. In the figure there are 34 inputs to test. After test (by passing in front of sensors) press enter, in case some sensor don't work the system will show that sensor.

ZONES TEST
Tot:34 V-stop

The output test is made by select the out and activate for 5 seconds. The figure shows the test screen. Use the ENTER key to activate the output.

TEST OUTPUTS
Tot:17 V-start

01-output one
Activate??

01-output one
Activated (4.3.2...)

For the CMS test, the call will be made to telephone number no. 1, communicating the life test event. The call is activated by pressing ENTER and waiting for it to arrive.

The event that is sent is always the life test (event no. 602).

It is possible test with all vectors, for each vector it is possible have feedback info.

TEST
VoiceCall PSTN/GSM

TEST
ContactID PSTN/GSM

TEST
ContactID GPRS/Lan

TEST
Sia FSK PSTN

TEST
Sia IP GPRS/Lan

TEST
4+2 PSTN/GSM

SMS MANAGEMENT

ARM/DISARM THE CONTROL UNIT VIA SMS

To arm and/or disarm the control unit you must have a user code:

UPWD:111111 ARM=T	TOTAL ARMING
UPWD:111111 ARM=1	PARTIAL1 ARMING
UPWD:111111 ARM=123	ARMING OF PARTIALS 1 - 2 - 3
UPWD:111111 DISARM=T	TOTAL DISARMING
UPWD:111111 DISARM= 2	DISARMING OF ONLY PARTIAL 2
UPWD:111111 DISARM= 12	DISARMING OF PARTIALS 1 - 2
UPWD:111111 ARM?	

ARMING STATUS REQUEST FROM THE CONTROL UNIT

ARM = 0 DISARMED
ARM =T TOTAL ARMED
ARM = 12 PARTIALS 1 - 2 ARMED

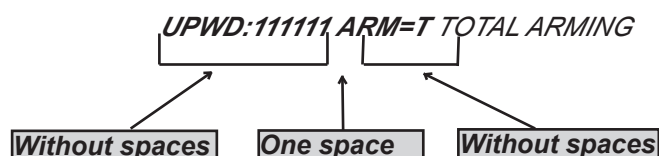

SMS COMMANDS

This is the complete list of all of the system programming/querying commands

LOCK	SYSTEM UNLOCK COMMAND (to allow to modify phone numbers) (LOCK=1 for unlock)
TPWD	TECHNICIAN PASSWORD DECLARATION (TPWD:000000 CODE)
UPWD	USER PASSWORD DECLARATION (UPWD:111111 CODE)
ARM	ARMING COMMAND (T=total 1=partial 1 etc.)
DISARM	DISARMING COMMAND (
OUT.x	OUTPUT SELECTION COMMAND
IN.x	INPUT SELECTION COMMAND
TEL.x	TELEPHONE SELECTION COMMAND
:	IS USED FOR USER/INSTALLER CODE
=	COMMAND FOR ASSIGN PARAMETER
?	REQUEST INFO COMMAD

HOW TO CREATE A REQUEST AND PROGRAMMING SMS

To send a command to the system you need follow a few simple rules:

For example, in order to the installer to change a telephone number, he must first have authorisation from the system owner (system unlock)

UPWD:111111 LOCK=OFF this command unlocks the programming via sms for 20 minutes.

This unlock must be done by the system owner. (final user)

Now the installer can give the command:

As you can see, the message is made up of two commands:

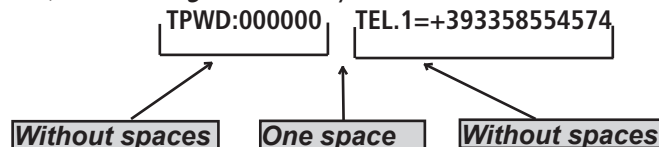

1 - the password declaration (TPWD:000000 or UPWD:111111) This command requires the (:) (colon) to enter the code.

2 - this is the operational part of the message that uses the (=) to assign the operation, the (?) to request information (a few examples follow)

TEL.1=+393358554574 setting telephone number response from the system TEL.1:OK

OUT.2=onoutput 2 activation response from the system OUT.:OK

OUT.4=off deactivation of output 4 response from the system OUT.4:OK

IN.2? input 2 status request response from the system IN.2=OP (if open) IN.2=CL (if at rest)

TECH KEYPAD MENU - 1

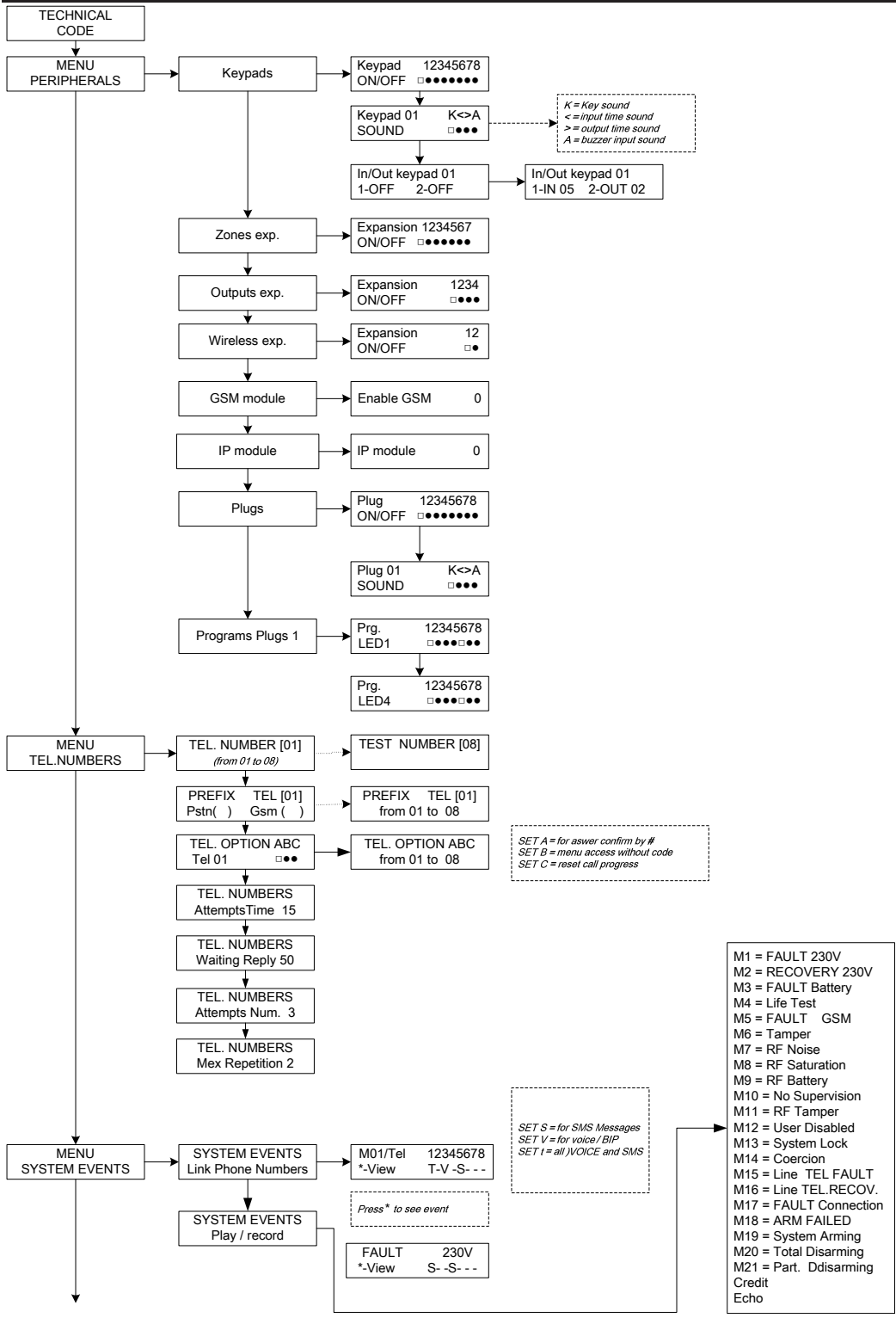

SET A = for answer confirm by #
 SET B = menu access without code
 SET C = reset call progress

SET S = for SMS Messages
 SET V = for voice / BIP
 SET I = all VOICE and SMS

- M1 = FAULT 230V
- M2 = RECOVERY 230V
- M3 = FAULT Battery
- M4 = Life Test
- M5 = FAULT GSM
- M6 = Tamper
- M7 = RF Noise
- M8 = RF Saturation
- M9 = RF Battery
- M10 = No Supervision
- M11 = RF Tamper
- M12 = User Disabled
- M13 = System Lock
- M14 = Coercion
- M15 = Line TEL FAULT
- M16 = Line TEL.RECOV.
- M17 = FAULT Connection
- M18 = ARM FAILED
- M19 = System Arming
- M20 = Total Disarming
- M21 = Part. Ddisarming
- Credit
- Echo

TECH KEYPAD MENU - 2

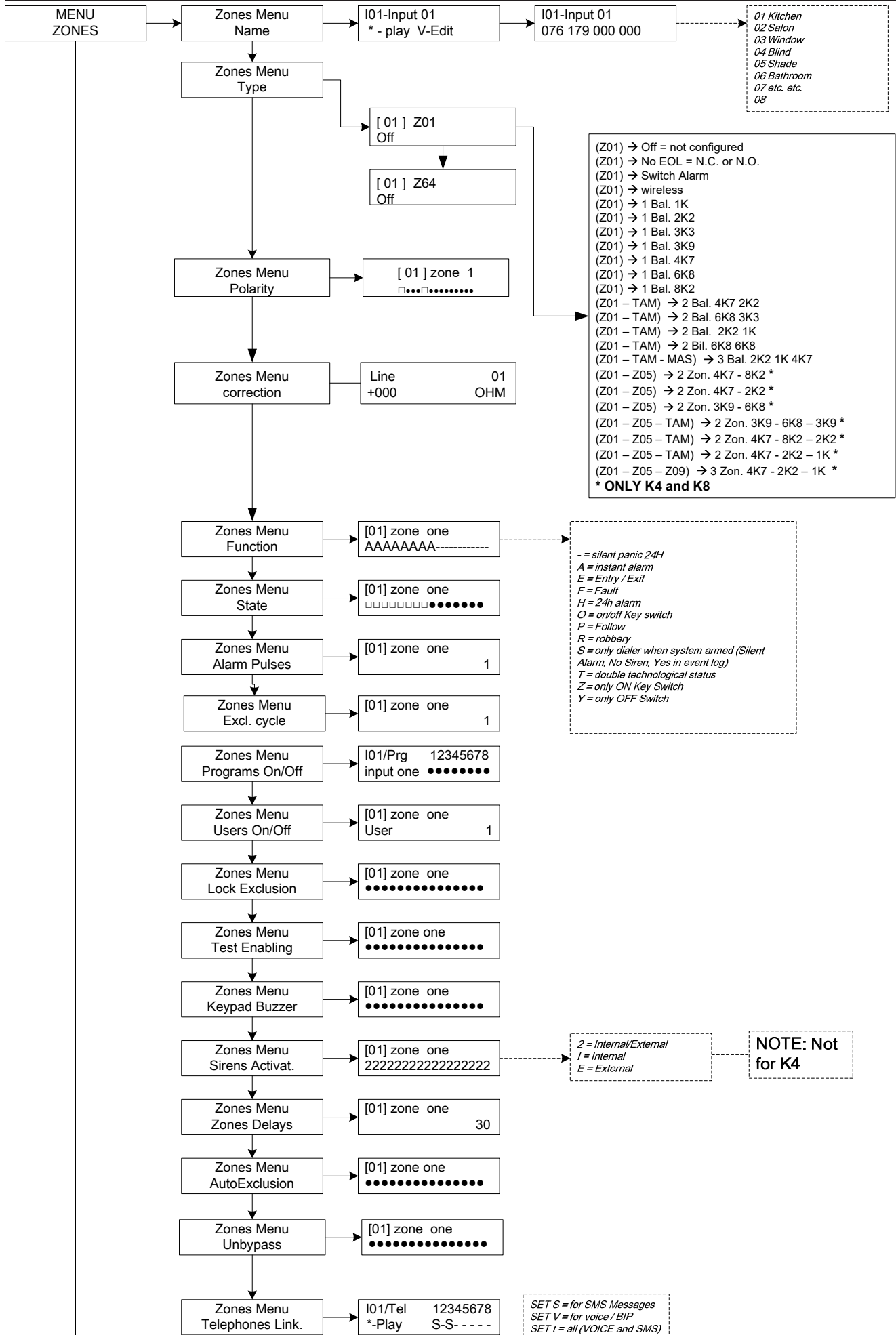

TECH KEYPAD MENU- 3

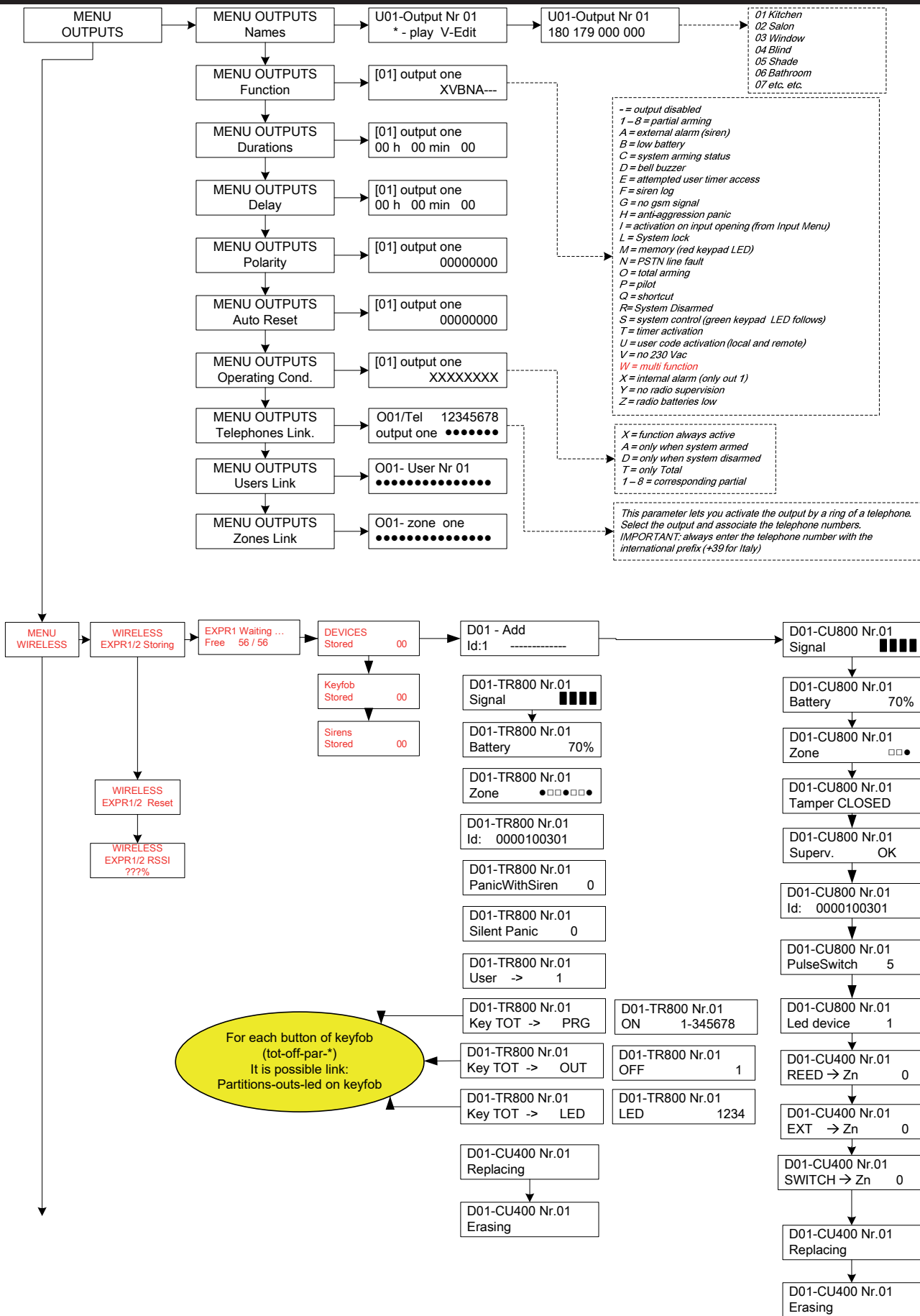

TECH KEYPAD MENU- 4

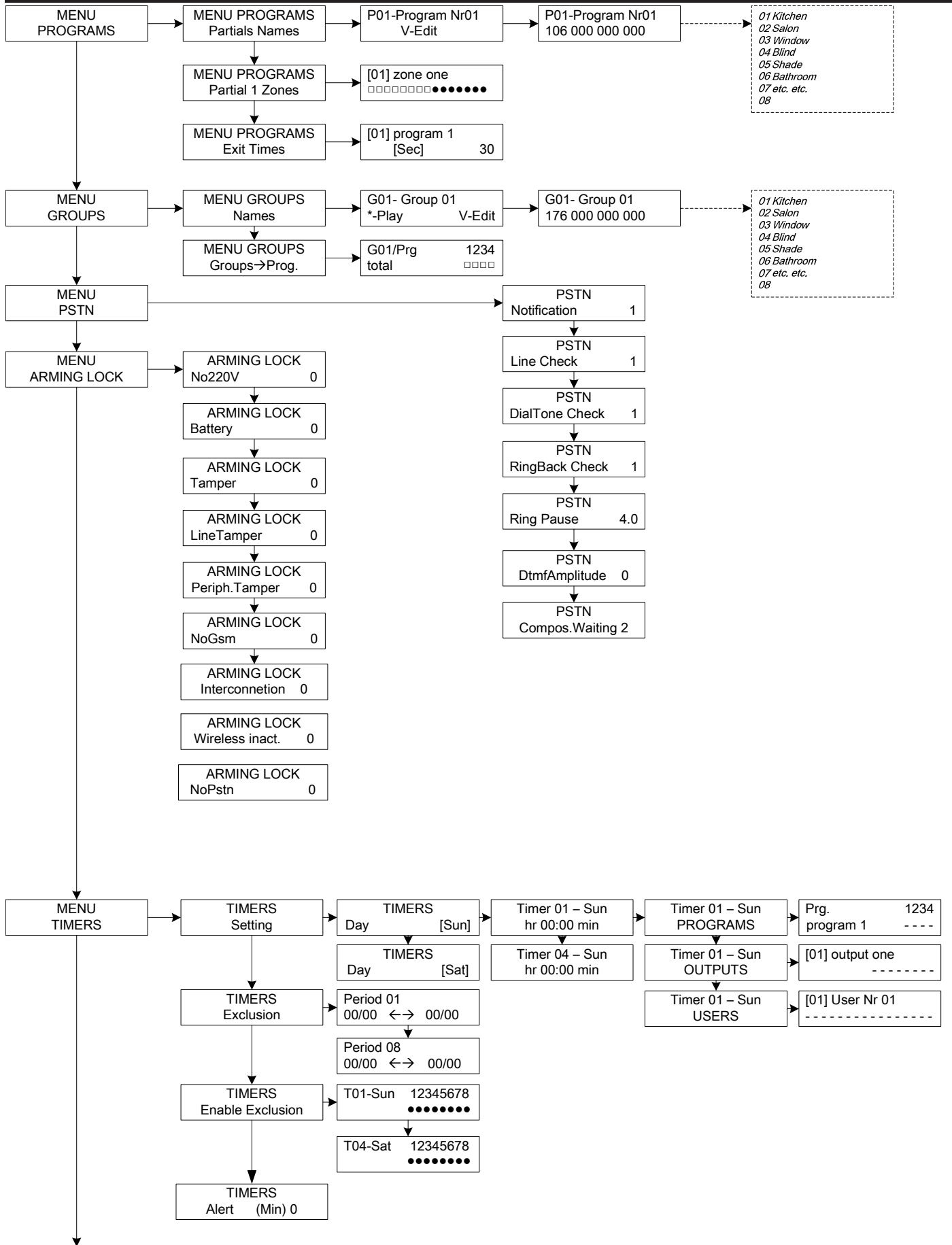

TECH KEYPAD MENU - 5

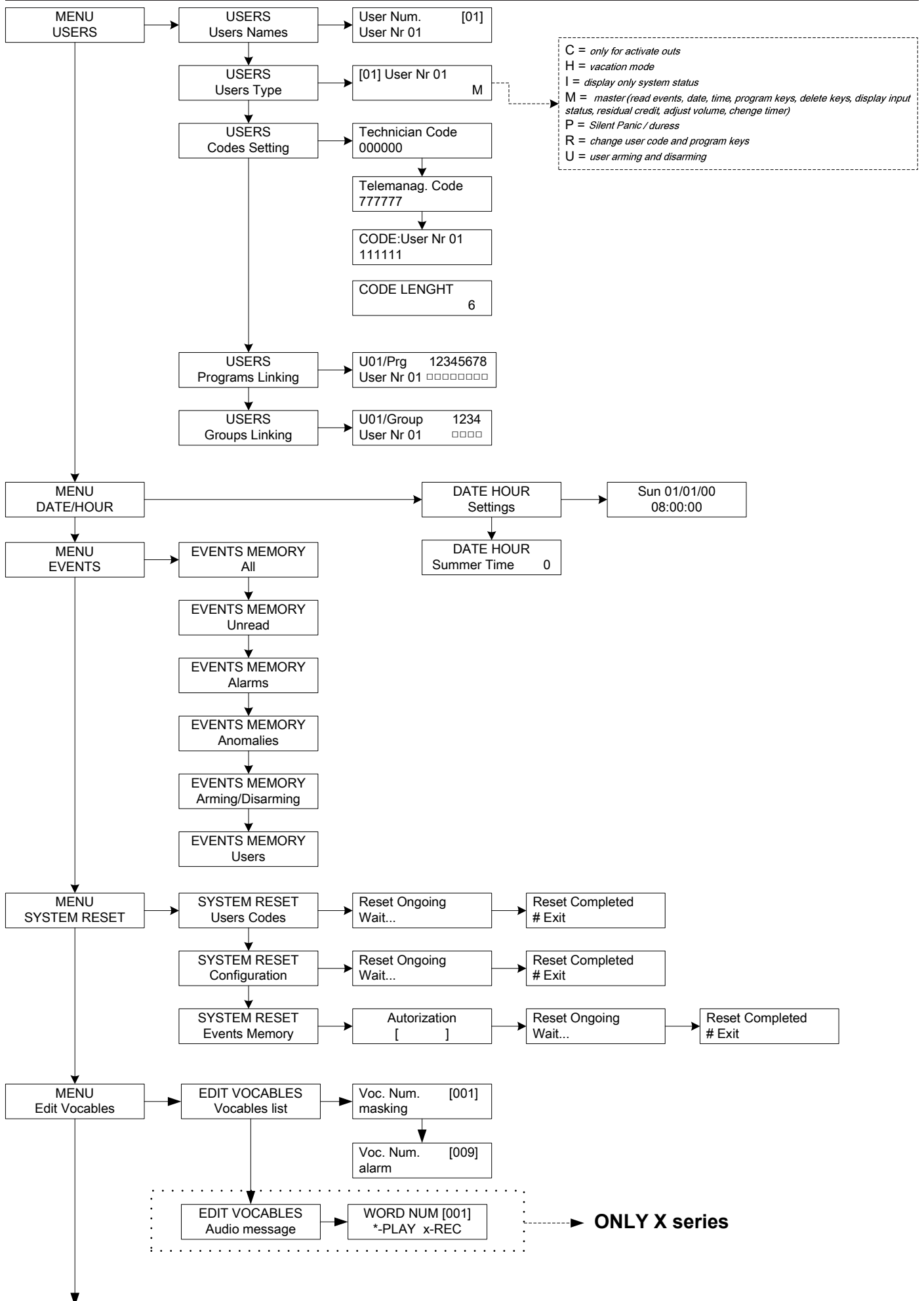

TECH KEYPAD MENU - 6

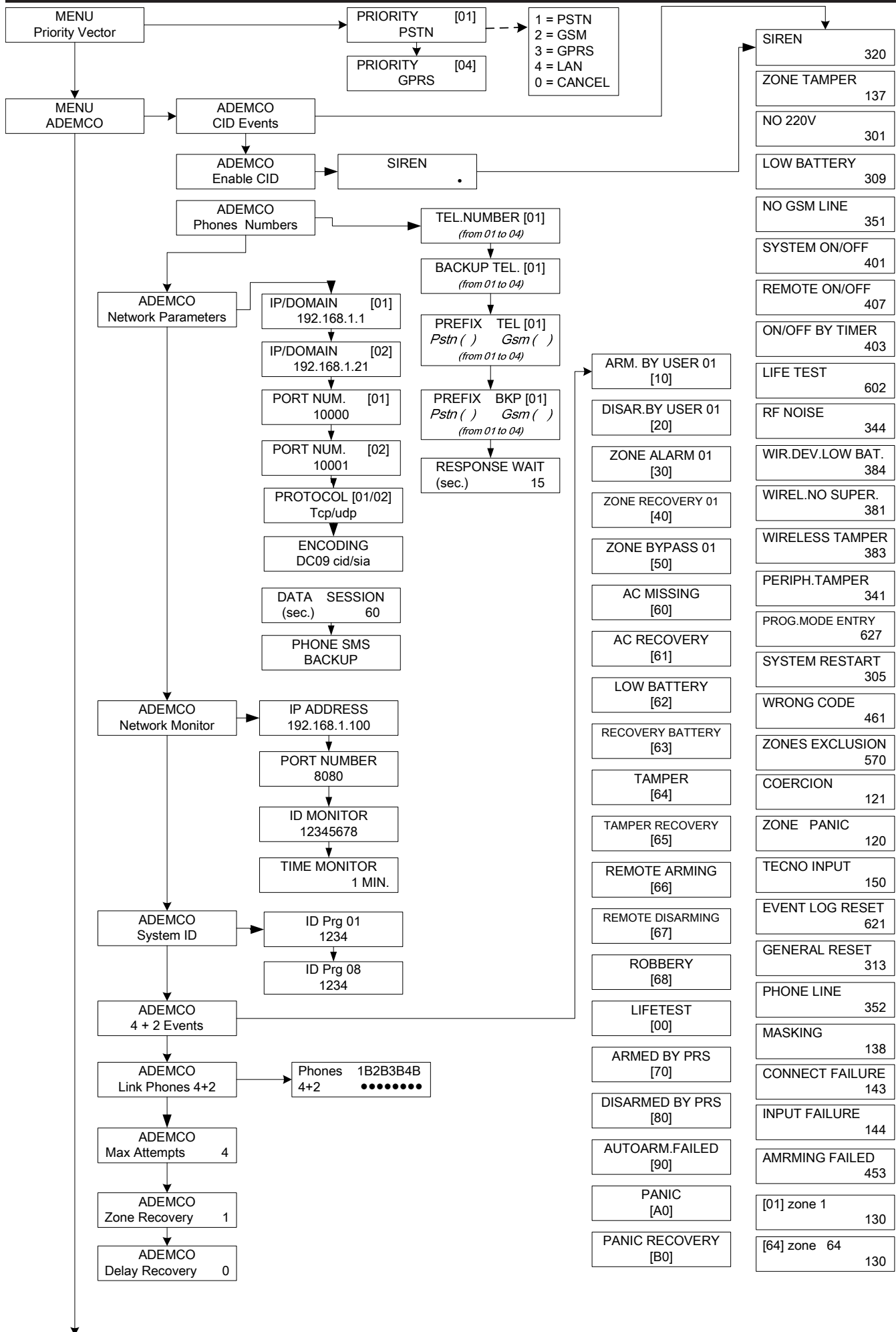

TECH KEYPAD MENU - 7

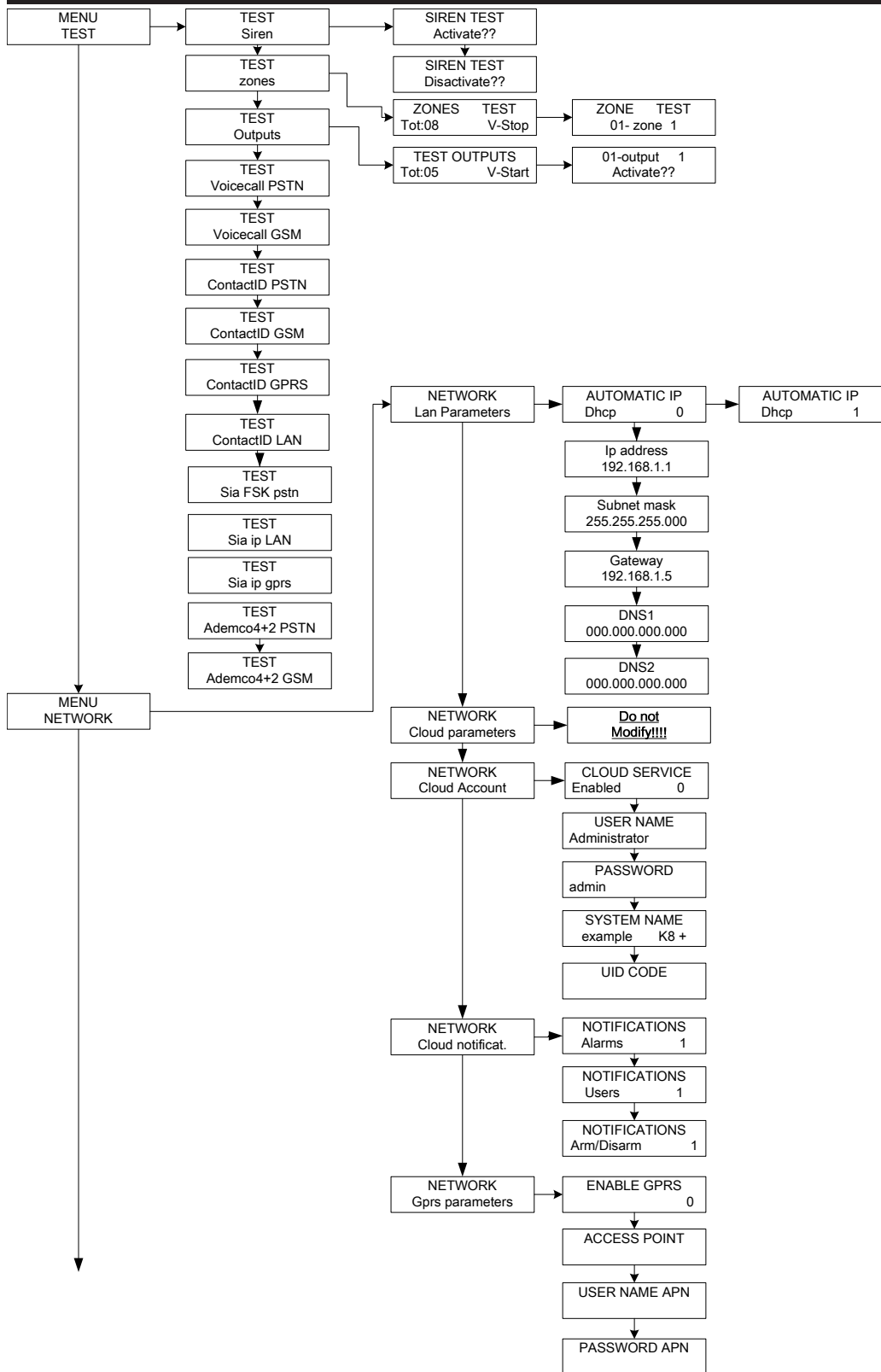

TECH KEYPAD MENU - 8

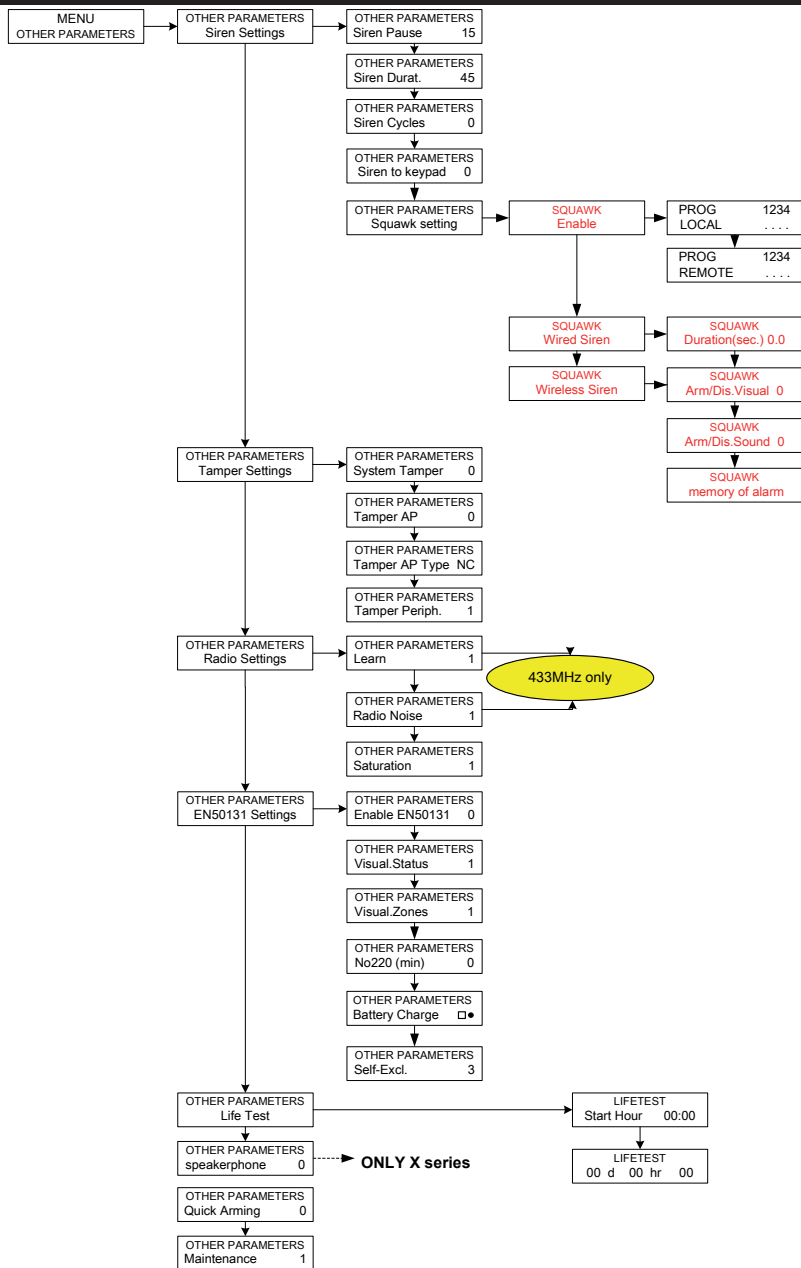

USER KEYPAD MENU - 1

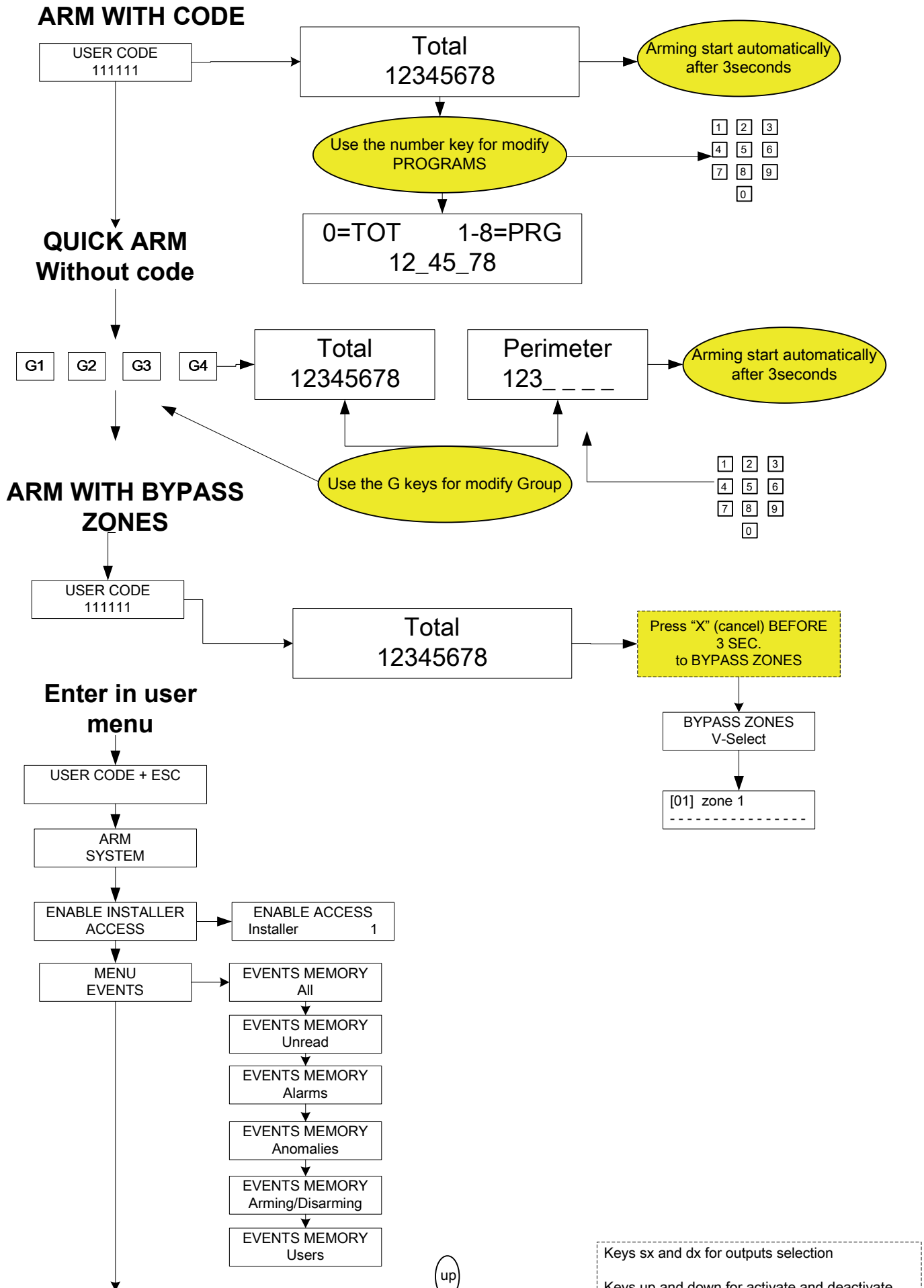

USER KEYPAD MENU - 2

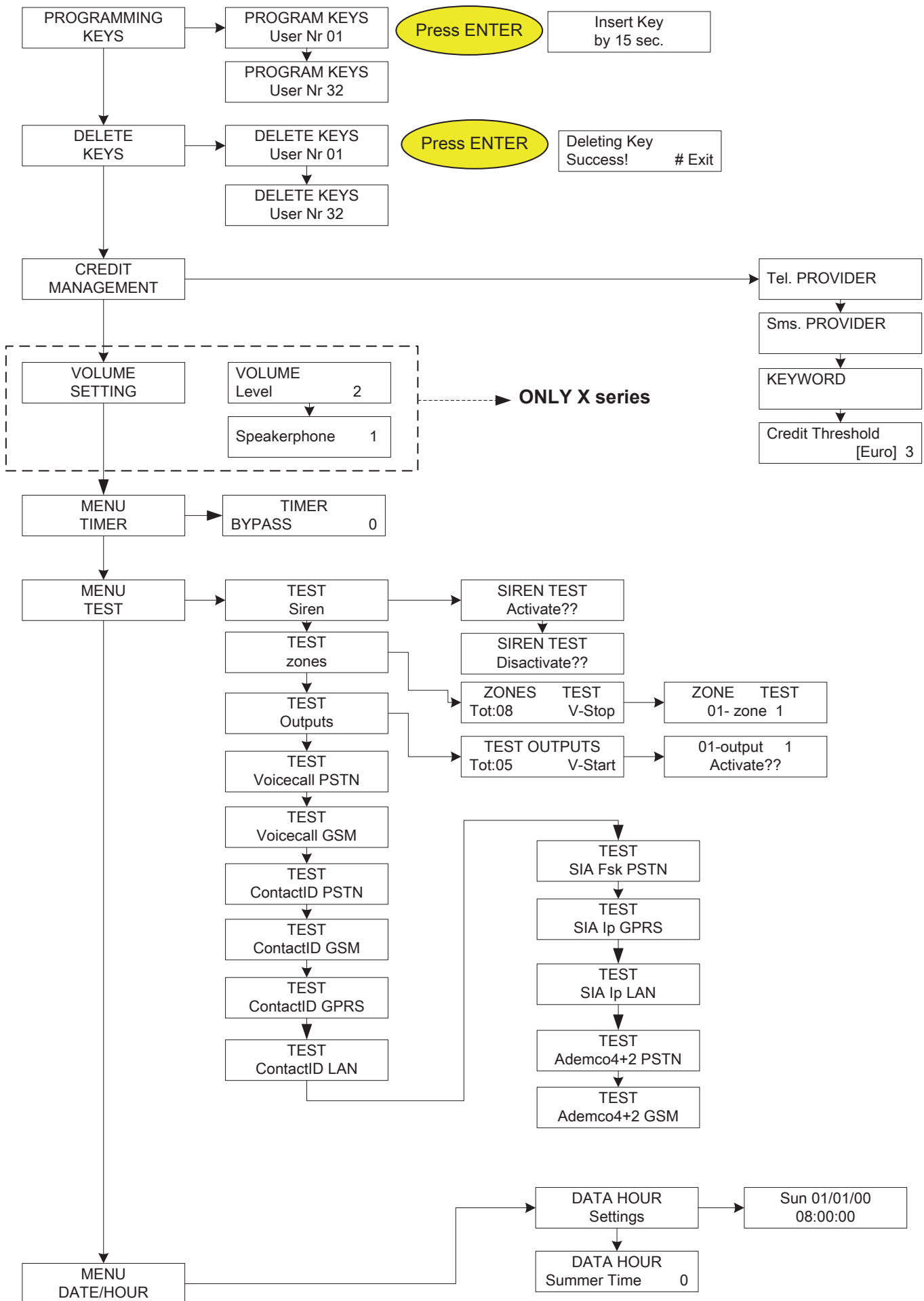

INDEX

IMPORTANT NOTES.....	2
GUARANTEE	2
COMPLIANCE	2
STANDARDS:EN 50136-1 + EN 50136-2 (GSM AND PSTN ALARM TRANSMISSION)	2
MANUFATURER	3
CONTENT OF THE METAL & METAL BOX.....	3
INTRODUCTION	4
ALARM COMUNICATION	4
NOTIFICATION EQUIPMENT DESCRIPTION AND CONFIGUARATION	4
LEVELS OF ACCESS	4
EVENT STORAGE SYSTEM.....	4
DEVICES FOR CONTROL OF THE SYSTEM.....	4
METAL BOX SPECIFICATION.....	7
PLASTIC BOX SPECIFICATION.....	8
WALL MOUNTING PLASTIC BOX	9
TAMPER PROTECTION	9
WIRING MAIN POWER AND EARTH.....	10
BACKUP BATTERY	12
WALL MOUNTING METAL BOX	13
METAL BOX FOR BATTERY 7AH.....	13
METAL BOX FOR BATTERY 17AH.....	14
TAMPER PROTECTION	15
WIRING MAIN POWER AND EARTH.....	16
BACKUP BATTERY & WIRING VIEW.....	17
METAL BOX FOR 17AH BATTERY VIEW	17
METAL BOX FOR 7AH BATTERY VIEW	18
MAIN BOARD K4 - K8 - K8PLUS.....	19
BOARD DESCRIPTION	19
K4 TERMINALS.....	19
JP1 AND JP2 JUMPER ON BOARD.....	19
K8 - K8 PLUS TERMINALS.....	20
JP1 AND JP2 JUMPER ON BOARD.....	20
MAIN BOARD X 412 - X 824 - 864.....	21
X PANEL BOARD	21
XPANELS TERMINALS.....	21
JP1 AND JP2 JUMPER ON BOARD.....	21
K LIGHT PLUS (TYPE B DEVICE)	22
K LIGHT (TYPE A DEVICE)	22
K LCD (TYPE A DEVICE).....	22
KX MODULES: KXIN - KXOUT	23
FIXING HOLES.....	23
KXIN TERMINALS	24
KXIN BOARD DESCRIPTION.....	24
KXOUT TERMINALS.....	24
KXOUT BOARD DESCRIPTION	24
IP1 MODULE.....	25
INSTALLATION ON PANEL	25
IP1 BOARD DESCRIPTION.....	26
SPECIFICATIONS IP BOARD	26
XGPRS MODULE	27
INSTALLATION ON PANEL	27
IP1 BOARD DESCRIPTION.....	28
SPECIFICATIONS XGPRS BOARD.....	28
LED DESCRIPTION.....	28
CONNECTIONS - SERIAL BUS	29
CONNECTIONS - SIRENS	29

CONNECTIONS - LOADS.....	29
CONNECTIONS - OUTPUTS.....	29
CONNECTIONS - ZONE TERMINALS.....	30
CONNECTIONS - PSTN TELEPHONE LINE	33
CONNECTIONS - BATTERY TERMINALS.....	33
TAMPER SWITCH KEY.....	33
PC CONNECTOR	33
PERIPHERALS THAT CAN BE CONNECTED	33
K-LIGHT	33
K-LIGHT PLUS	33
K-LCD AND K-VOICE TERMINAL	34
K-RADIO KEYPADS NOT CERTIFIED EN 50131.....	35
INPUT EXPANSIONS "KXIN"	35
OUTPUT EXPANSIONS "KXOUT"	36
EXPR/S RADIO EXPANSION NOT CERTIFIED EN 50131	36
TAG READER PROXIMITY NOT CERTIFIED EN 50131	37
FIRST START UP	38
STARTING RESET	38
DISARM KEYPAD STATUS	38
PROGRAMMING (FROM KEYBOARD)	38
ENTER PROGRAMMING MOVE TO THE MENU	38
EN 50131 CONFIGURATOR	38
PERIPHERALS MENU	39
K LIGHT PLUS TERMINAL PROGRAMMING	39
MENU OF TELEPHONE NUMBERS.....	40
SYSTEM EVENTS MENU.....	41
LINK PHONE NUM.	41
ZONES MENU	42
ZONES: NAME.....	42
XSERIES VOCABULARY	43
KSERIES VOCABULARY (ALL EDITABLE).....	44
ZONES MENU: TYPE	45
ZONES MENU: POLARITY	47
ZONES MENU: CORRECTION	48
MENU OF INPUTS: FUNCTION.....	48
MENU OF INPUTS: STATE	49
ZONES MENU: ALARM PULSES	49
ZONES MENU: EXCLUSION CYCLES.....	49
ZONES MENU: PROGRAMS ON/OFF	49
ZONES MENU: USERS ON/OFF.....	49
ZONES MENU: LOCK EXCLUSION	50
ZONES MENU: TEST ENABLING	50
ZONES MENU: KEYPAD BUZZER	50
ZONES MENU: SIRENS ACTIVATION.....	50
ZONES MENU: ZONES DELAYS.....	51
ZONES MENU: AUTOEXCLUSION	51
ZONES MENU: UNBYPASS.....	51
ZONES MENU: TELEPHONES LINK.....	51
MENU OF OUTPUTS	52
MENU OF OUTPUTS: NAMES.....	52
MENU OF OUTPUTS: FUNCTION.....	53
MENU OF OUTPUTS: DURATION.....	54
MENU OF OUTPUTS: DELAY	54
MENU OF OUTPUTS: POLARITY	54
MENU OF OUTPUTS: AUTORESET	54
MENU OF OUTPUTS: OPERATING CONDITIONS	55
MENU OF OUTPUTS: TELEPHONES LINK.	55
MENU OF OUTPUTS: USERS LINK	55

MENU OF OUTPUTS: INPUTS LINK.....	55
WIRELESS MENU 868MHZ FULL DUPLEX.....	56
WIRELESS MENU: LEARNING	56
KEYFOB SETUP	58
KEYFOB LED REPORT	59
WIRELESS MENU: EXPR RESET	59
WIRELESS MENU: RSSI	59
PROGRAMS MENU	60
PROGRAMS MENU: PARTIALS NAMES.....	60
PROGRAMS MENU: PARTIAL ZONES (ASSIGNING ZONES TO PARTIALS)	60
PROGRAMS MENU: EXIT TIMES.....	60
GROUPS MENU.....	60
GROUPS MENU: NAMES	60
GROUPS MENU: GROUPS (ASSOCIATE PARTIALS TO GROUPS).....	60
ASSOCIATE PARTIALS TO GROUPS: IN THE FIGURE AT GROUP 1 (PERIMETER) ARE ASSOCIATED THE FIRST 3 PARTIAL.	60
PSTN MENU.....	61
ARMING LOCK MENU	62
TIMERS MENU	63
TIMERS MENU: SETTING.....	63
TIMERS MENU: EXCLUSIONS	64
TIMERS MENU: ENABLE EXCLUSIONS.....	64
MENU USERS.....	65
MENU USERS: USER NAMES	65
MENU USERS: USERS TYPE.....	65
MENU USERS: CODES AND LENGHT CODES	65
MENU USERS: PROGRAMS LINKING.....	65
QUICK ARM USER	65
DATE/HOUR MENU	65
EVENTS MENU.....	66
SYSTEM RESET MENU	67
EDIT VOCABLES MENU.....	67
MENU PRIORITY VECTOR	67
ADEMCO MENU.....	68
CID EVENTS	68
ENABLE CID	68
ADEMCO PHONE NUMBER	68
RESPONSE WAIT	68
ADEMCO NETWORK PARAMETERS.....	69
ADEMCO NETWORK MONITOR	69
ADEMCO SYSTEM ID.....	69
4+2 EVENTS	70
ADEMCO - MAX ATTEMPTS.....	70
ADEMCO - ZONES RECOVERY	70
ADEMCO - DELAY RECOVERY.....	70
TEST MENU.....	71
MENU NETWORK.....	73
LAN PARAMETER.....	73
CLOUD PARAMETERS.....	73
ACCOUNT	73
CLOUD NOTIFIC.	73
GPRS PARAMETER	73
MENU OTHER PARAMETERS	74
OTHER PARAMETERS: SIREN SETTINGS.....	74
SIREN SETTINGS: SIREN DURATION	74
SIREN SETTINGS: SIREN PAUSE.....	74
SIREN SETTINGS: SIREN CYCLES	74
SIREN SETTINGS: SIREN TO KEYPAD.....	74
SIREN SETTINGS: SQUAWK FUNCTION	74

OTHER PARAMETERS: TAMPER SETTINGS	75
TAMPER SETTINGS: SYSTEM TAMPER	75
TAMPER SETTINGS: TAMPER AP	75
TAMPER SETTINGS: TAMPER AP TYPE	75
TAMPER SETTINGS: TAMPER PERIPHERALS	75
OTHER PARAMETERS: DIALER SETTINGS (ONLY X SERIES).....	75
DIALER SETTINGS: RING NUMBER.....	75
DIALER SETTINGS: EVENT DELAY	75
OTHER PARAMETERS: SPEAKERPHONE (ONLY X SERIES).....	75
OTHER PARAMETERS: RADIO SETTINGS.....	75
RADIO SETTINGS: LEARN (433MHZ ONLY).....	75
RADIO SETTINGS: SATURATION	75
RADIO SETTINGS: RADIO NOISE (433MHZ ONLY)	75
OTHER PARAMETERS: EN50131 SETTINGS	76
EN50131 SETTINGS: ENABLE 50131	76
EN50131 SETTINGS: VISUAL.STATUS	76
EN50131 SETTINGS: VISUAL.ZONES	76
EN50131 SETTINGS: NO 220 (MIN).....	76
EN50131 SETTINGS: CHARGE BATTERY.....	76
EN50131 SETTINGS EN 50131: SELF-EXCLUSION	76
OTHER PARAMETERS: LIFE TEST	76
OTHER PARAMETERS: QUICK ARMING	76
OTHER PARAMETERS: MAINTENANCE.....	76
PROGRAMMING PANEL WITH SOFTWARE	77
AMC AMANAGER APP	78
REGISTER APP	78
ADD PANEL TO THE APP	79
TROUBLES AND STATUS INFO.....	80
HOW TO USE THE SYSTEM (USER MANUAL)	81
ARM/DISARM PARTIALS	81
ARM/DISARM GROUPS	81
BYPASS ZONE	81
NOTIFICATIONS (QUICK VIEW OF LAST EVENTS).....	82
EVENTS MENU.....	82
SYSTEM INFO.....	82
ENABLE INSTALLER ACCESS	83
ENABLE REMOTE MANAGEMENT.....	83
CHANGE CODE MENU	83
DATE/TIME MENU.....	83
ACTIVATE PROGRAMMED OUTPUTS.....	83
SHORTCUT	83
MENU TIMER	84
PROGRAMMING AND CANCELLING KEYS	84
CREDIT MANAGEMENT.....	84
MENU NETWORK.....	84
ACCOUNT CLOUD.....	84
TEST MENU.....	85
SMS MANAGEMENT	86
ARM/DISARM THE CONTROL UNIT VIA SMS	86
SMS COMMANDS	86
HOW TO CREATE A REQUEST AND PROGRAMMING SMS	86
TECH KEYPAD MENU - 1	87
TECH KEYPAD MENU - 2	88
TECH KEYPAD MENU- 3	89
TECH KEYPAD MENU- 4	90
TECH KEYPAD MENU - 5	91
TECH KEYPAD MENU - 6	92
TECH KEYPAD MENU - 7	93

TECH KEYPAD MENU - 8	94
USER KEYPAD MENU - 1	95
USER KEYPAD MENU - 2	96