

**Installation**

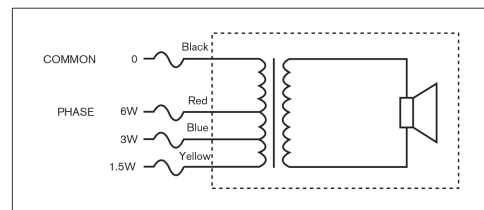

Circuit diagram

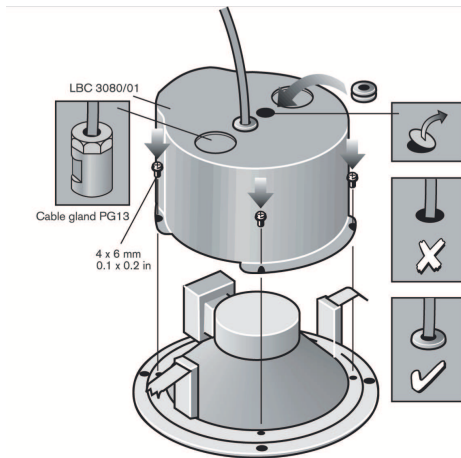
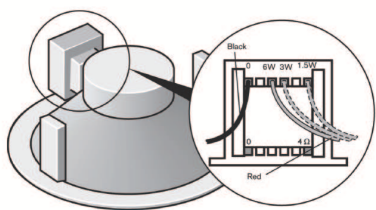
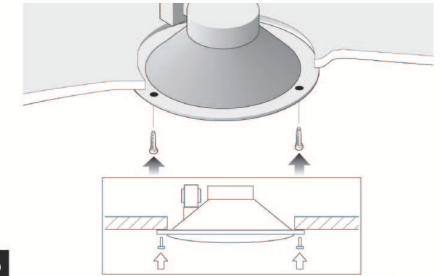
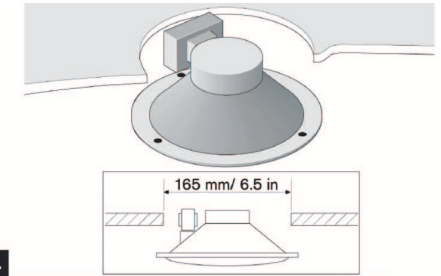
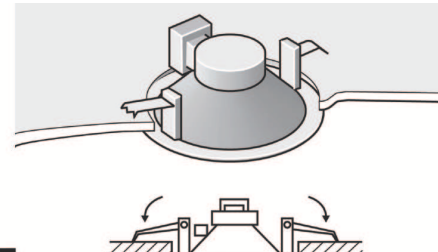
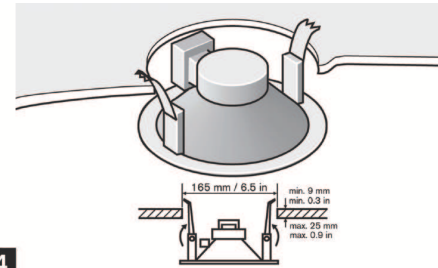
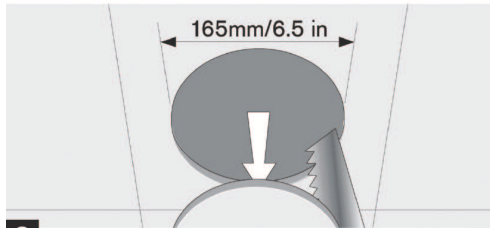
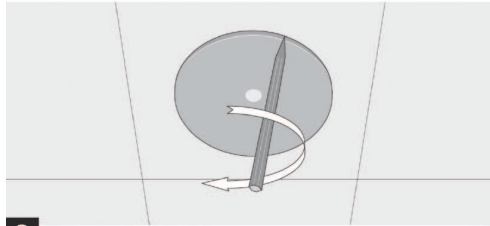
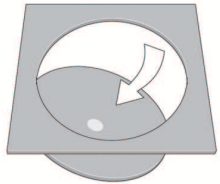
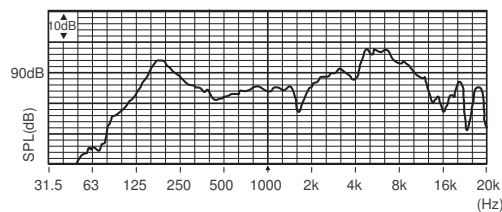

Frequency response

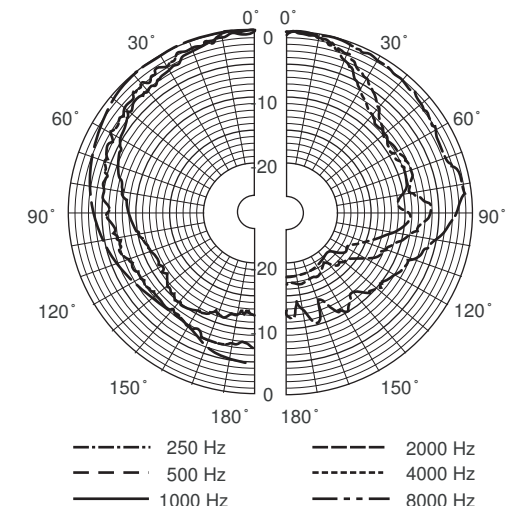

Polar diagram (measured with pink noise)

## Technical data

### Electrical

Maximum power	9 W
Rated power	6 / 3 / 1.5 W
Sound pressure level at 6 W / 1 W (1 kHz, 1 m)	94 dB / 86 dB (SPL)
Sound pressure level at 6 W / 1 W (4 kHz, 1 m)	106 dB / 98 dB (SPL)
Effective frequency range (-10 dB)	80 Hz to 18 kHz
Opening angle at 1 kHz/4 kHz (-6 dB)	175° / 55°
Rated voltage	100 V
Rated impedance	1667 ohm
Connection	Flying leads

### Mechanical

Diameter	199 mm (7.8 in)
Maximum depth	70.5 mm (2.8 in)
Mounting cut-out	165 + 5 mm (6.5 + 0.20 in)
Speaker diameter	152.4 mm (6 in)
Weight	620 g (1.37 lb)
Color	White (RAL 9010)

### Environmental

Operating temperature	-25 °C to +55 °C (-13 °F to +131 °F)
Storage and transport temperature	-40 °C to +70 °C (-40 °F to +158 °F)
Relative humidity	<95%

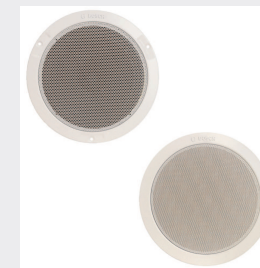

LHM0606/xx Ceiling loudspeaker



en Installation note