

# HID Aero™ X300 Output Control Module

PLT-04236, Rev. A.3

## Supplied parts

- HID Aero X300 Output Control Module (1)
- Installation guide (1)
- Mounting screws (4) 0.138" × 1" (3.5 mm × 25 mm)

## Recommended parts (not supplied)

- Certified DC power supply
- Drill with various bits for mounting hardware
- For DIN rail mounting: Brackets (2) - Phoenix Contact, USA 10 Series Rail Adapter, part number 1201578.  
Screws (4) - Self tapping, countersunk, 3.0 mm × 10 mm (or 3.0 mm × 8 mm)

CABLE REQUIREMENTS (NOT SUPPLIED)	
IO Module	One twisted pair, shielded, 24 AWG, 120Ω impedance, 4,000 ft (1,200 m) maximum
Alarm Inputs	One twisted pair, 30Ω maximum
Relay Outputs	As required for the load
Power	2-conductor shielded 18 to 16 AWG, 500 ft (150 m)

## X300 Overview

The X300 has 12 relays, five inputs and one RS-485 port for IO module connection.

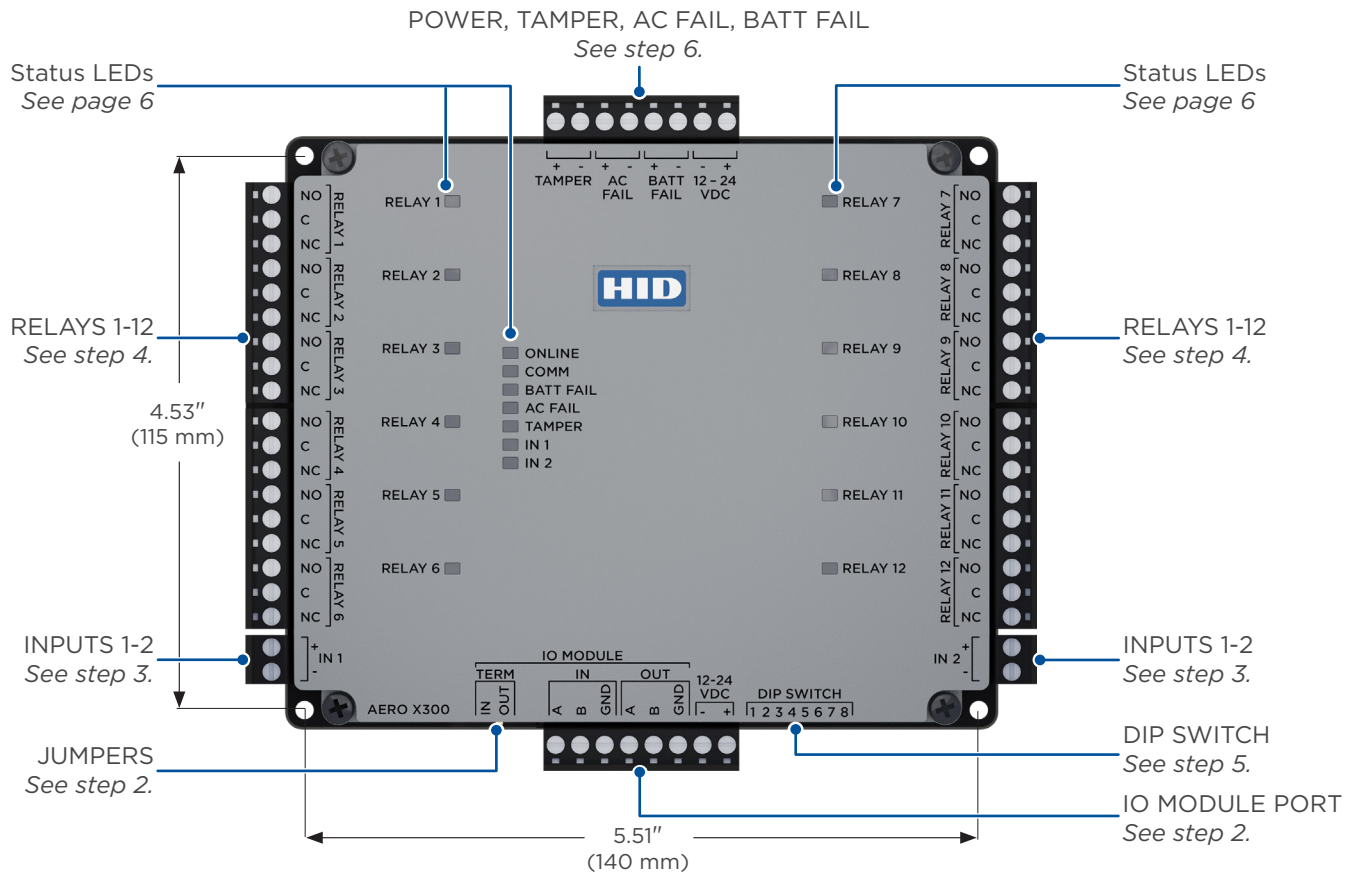

© 2019 - 2020 HID Global Corporation/ASSA ABLOY AB. All rights reserved. HID, the HID Brick logo, the Chain Design, and HID Aero are trademarks or registered trademarks of HID Global, ASSA ABLOY AB, or its affiliate(s) in the US and other countries and may not be used without permission. All other trademarks, service marks, and product or service names are trademarks or registered trademarks of their respective owners.

# 1. Mounting the X300



**ATTENTION**

Observe precautions for handling  
ELECTROSTATIC SENSITIVE DEVICES

- Always mount the controllers and interface panels in a secure area.
  - Mount using the supplied screws 0.138" × 1" (3.5 mm × 25 mm).
  - Alternatively mount on a DIN rail using compatible DIN rail mounting brackets and screws.  
*See Recommended parts.*
- Note:** The side terminal connectors must be removed to fit the mounting brackets.

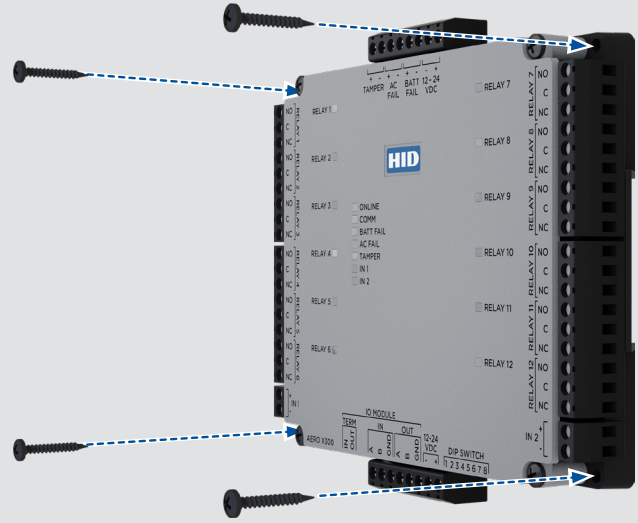

# 2. Communication wiring

Connect the X300 to the Aero X1100 intelligent controller using IO Module ports (2-wire RS-485).

Use 1-twisted pair, shielded cable, 120Ω impedance, 24 AWG, 4,000 ft. (1,219 m) maximum.

**Note:** Both **IN** and **OUT** terminals on the **IO MODULE** are the same port and are internally connected.

## Setting the termination jumpers

Install RS-485 termination jumpers on the interface boards at each end of the communication bus only. Failure to do so will compromise the proper operation of the communication channel.

JUMPER	DESCRIPTION
IN	Install only on the first and last unit on the communication bus.
OUT	Install only if not the first or last unit on the communication bus.

### IO MODULE IN or IO MODULE OUT

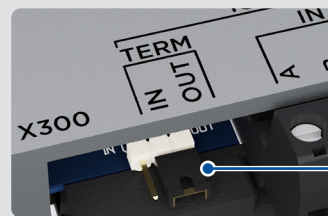
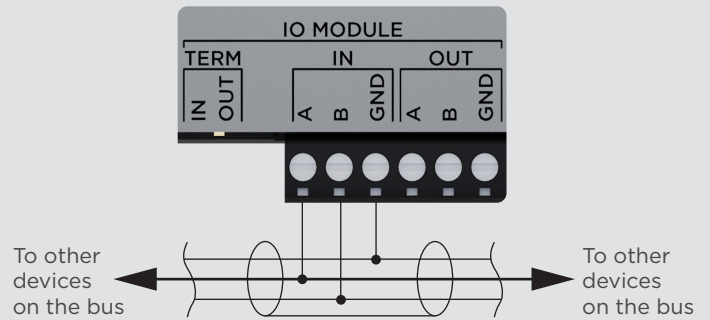

RS-485 termination jumper

### 3. Input circuit wiring

Inputs are typically used for the following:

- To monitor door position.
- Request to exit.
- Alarm contacts.

Input **IN 1** and **IN 2** circuits can be configured as unsupervised or supervised and can use normally open or normally closed contacts.

For a supervised circuit, add two 1K $\Omega$ , 1% resistors as close to the sensor as possible.

Custom end of line (EOL) resistances may be configured via the host software.

**Note:** The input circuit wiring configurations shown are supported but may not be typical.

Unsupervised circuit IN 1 or IN 2

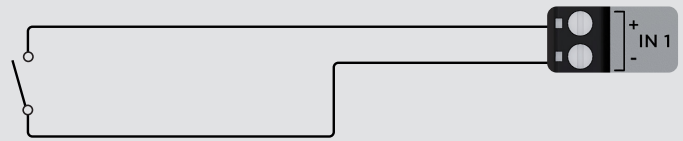

Supervised circuit IN 1 or IN 2

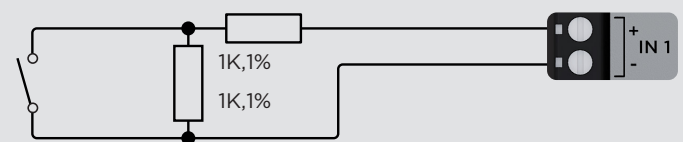

### 4. Relay circuit wiring

Twelve relays are provided for controlling door lock mechanisms or alarm signaling.

When controlling the delivery of power to the door strike, the **NO** (Normally Open) and **C** (Common) poles are typically used.

When momentarily removing power to unlock the door, as with a mag lock, the **NC** (Normally Closed) and **C** (Common) poles are typically used.

Check with local building codes for proper egress door installation.

**CAUTION**

**Door lock mechanisms can generate feedback to the relay circuit. This can cause damage and premature failure of the relay, affecting the operation of the X300. Use a diode to protect the relay. Use a wire of sufficient gauge to avoid voltage loss.**

DC Strike

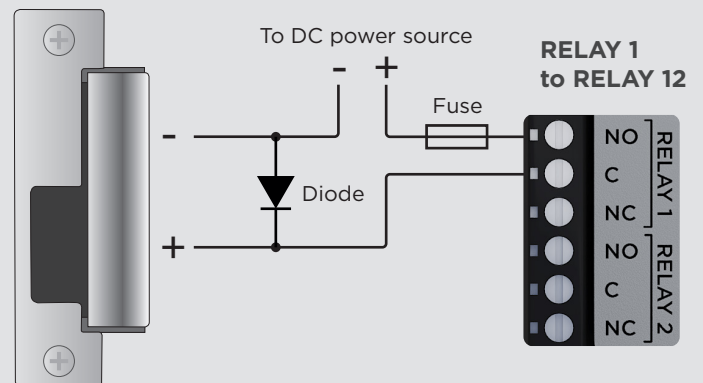

**Diode selection:**

- Diode current rating: 1x strike current.
- Diode breakdown voltage: 4x strike voltage.
- For 12 V DC or 24 V DC strike, diode 1N4002 (100V/1A) typical.

## 5. DIP switch configuration

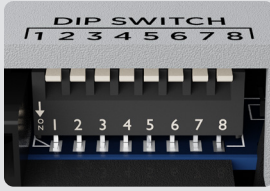

Switches 1 through 5 select the device address. Switches 6 and 7 select the communication baud rate. Switch 8 is not in use.

1	2	3	4	5	6	7	8	SELECTION
OFF	OFF	OFF	OFF	OFF				Address 0
ON	OFF	OFF	OFF	OFF				Address 1
OFF	ON	OFF	OFF	OFF				Address 2
ON	ON	OFF	OFF	OFF				Address 3
OFF	OFF	ON	OFF	OFF				Address 4
ON	OFF	ON	OFF	OFF				Address 5
OFF	ON	ON	OFF	OFF				Address 6
ON	ON	ON	OFF	OFF				Address 7
OFF	OFF	OFF	ON	OFF				Address 8
ON	OFF	OFF	ON	OFF				Address 9
OFF	ON	OFF	ON	OFF				Address 10
ON	ON	OFF	ON	OFF				Address 11
OFF	OFF	ON	ON	OFF				Address 12
ON	OFF	ON	ON	OFF				Address 13
OFF	ON	ON	ON	OFF				Address 14
ON	ON	ON	ON	OFF				Address 15
OFF	OFF	OFF	OFF	ON				Address 16
ON	OFF	OFF	OFF	ON				Address 17
OFF	ON	OFF	OFF	ON				Address 18
ON	ON	OFF	OFF	ON				Address 19
OFF	OFF	ON	OFF	ON				Address 20
ON	OFF	ON	OFF	ON				Address 21
OFF	ON	ON	OFF	ON				Address 22
ON	ON	ON	OFF	ON				Address 23
OFF	OFF	OFF	ON	ON				Address 24
ON	OFF	OFF	ON	ON				Address 25
OFF	ON	OFF	ON	ON				Address 26
ON	ON	OFF	ON	ON				Address 27
OFF	OFF	ON	ON	ON				Address 28
ON	OFF	ON	ON	ON				Address 29
OFF	ON	ON	ON	ON				Address 30
ON	ON	ON	ON	ON				Address 31
					OFF	OFF		115,200 BPS
					ON	ON		38,400 BPS
					OFF	ON		19,200 BPS
					ON	OFF		9,600 BPS

## 6. Input power, cabinet tamper, and UPS fault input wiring

The X300 requires 12-24 V DC power. Connect power with minimum of 18 AWG wire.

**Connect power ground to earth ground in only ONE LOCATION within the system. Multiple earth ground connections may cause ground loop problems and is not advised.**

**Observe POLARITY on 12-24 V DC input.**

Connect the **AC FAIL** and **BATT FAIL** inputs to the corresponding contacts provided on the power supply. Connect the **TAMPER** input to a tamper switch on the enclosure.

**TAMPER, AC FAIL**, and **BATT FAIL** connections are identical to inputs **IN 1** to **IN 2** and can be configured as unsupervised or supervised. See *step 3. Input circuit wiring*.

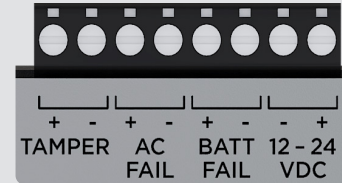

## Status LEDs

LED	POWER ON SELF-TEST	NORMAL OPERATION
<b>ONLINE</b>	ON then OFF	Heartbeat and Online status. Offline = 1 sec rate, 20% ON. Online encrypted comm .1 sec ON, .1 sec OFF, .1 sec ON, .1 sec OFF, .1 sec ON, .1 sec OFF, .1 sec ON, .3 sec OFF. Waiting for application download .1 sec ON, .1 sec OFF.
<b>COMM</b>	ON then OFF	RS-485 comm status. Indicates communication activity on the SIO communication port.
<b>BATT FAIL</b>	ON then OFF	OFF = Inactive, ON = Active, Flash = Fault.*
<b>AC FAIL</b>	ON then OFF	OFF = Inactive, ON = Active, Flash = Fault.*
<b>TAMPER</b>	ON then OFF	OFF = Inactive, ON = Active, Flash = Fault.*
<b>RELAY 1</b>	OFF	ON = Energized
<b>RELAY 2</b>	OFF	ON = Energized
<b>RELAY 3</b>	OFF	ON = Energized
<b>RELAY 4</b>	OFF	ON = Energized
<b>RELAY 5</b>	OFF	ON = Energized
<b>RELAY 6</b>	OFF	ON = Energized
<b>RELAY 7</b>	OFF	ON = Energized
<b>RELAY 8</b>	OFF	ON = Energized
<b>RELAY 9</b>	OFF	ON = Energized
<b>RELAY 10</b>	OFF	ON = Energized
<b>RELAY 11</b>	OFF	ON = Energized
<b>RELAY 12</b>	OFF	ON = Energized
<b>IN 1</b>	ON then OFF	OFF = Inactive, ON = Active, Flash = Fault.*
<b>IN 2</b>	ON then OFF	OFF = Inactive, ON = Active, Flash = Fault.*

\*If this input is defined, every three seconds the LED is pulsed to its opposite state for 0.1 seconds, otherwise, the LED is OFF.

## Specifications

<b>HID AERO X300</b>	
Input Voltage	12 to 24 V DC ± 10%
Maximum Input Current	500 mA
IO Module	2-wire RS-485, 2,400 to 115,200 bps, asynchronous, half-duplex, 1 start bit, 8 data bits, and 1 stop bit
Inputs	Five unsupervised/supervised, standard EOL: 1k/1kΩ, 1%, ¼ watt (Includes TAMPER, AC FAIL, and BATT FAIL inputs) UL evaluation for access control use only
Output Relays	Twelve Form-C relays. Contact rating: 2 A @ 30 V DC resistive
<b>ENVIRONMENTAL</b>	
Operating Temperature	32 to 158°F (0 to +70°C)
Storage Temperature	-67 to 185°F (-55 to +85°C)
Humidity	5 to 85% RHNC
<b>MECHANICAL</b>	
Dimension	6.46" × 5.51" × 1.02" (164 mm × 140 mm × 26 mm)
Weight	342 g

These specifications are subject to change without notice.

## Regulatory

### UL Recognized Component (UL294)

All National and local Electrical codes apply.

This equipment is intended to be powered from a limited power source output, of a UL294 Certified Power Supply. Install in accordance with NFPA70 (NEC) Local Codes, and authorities having jurisdiction. Follow all National and Local Codes.

Changes or modifications not expressly approved by the party responsible for compliance could void the user's authority to operate the equipment.

#### UL 294 Performance Levels

MODEL #	ACCESS CONTROL LINE SECURITY LEVEL	DESTRUCTIVE ATTACK LEVEL	ENDURANCE LEVEL	STAND-BY POWER LEVEL	CONDITIONS
X300	Level I	Level I	Level IV	Level I	

### US-FCC:

#### Class A Digital Devices FCC Compliance Statement:

This equipment has been tested and found to comply with the limits for a Class A digital device, pursuant to part 15 of the FCC Rules. These limits are designed to provide reasonable protection against harmful interference when the equipment is operated in a commercial environment. This equipment generates, uses, and can radiate radio frequency energy and, if not installed and used in accordance with the instruction manual, may cause harmful interference to radio communications. Operation of this equipment in a residential area is likely to cause harmful interference in which case the user will be required to correct the interference at their own expense.

### Taiwan-BSMI Class A Notice

警告使用者：  
這是甲類的資訊產品，在居住的環境中使用時，可能會造成射頻干擾，在這種情況下，伊用者會被要求採取某些適當的耐策。

### Japan

この装置は、クラスA機器です。この装置を住宅環境で使用すると電波妨害を引き起こすことがあります。この場合には使用者が適切な対策を講ずるよう要求されることがあります。VCCI - A

#### Your HID product is marked to indicate its compliance class:

- Federal Communications Commission (FCC) - USA
- Industry Canada Equipment Standard for Digital Equipment (ICES-003) - Canada
- CE Mark - Europe
- RCM Mark - New Zealand and Australia
- Voluntary Control Council for Interference (VCCI) - Japan
- Bureau of Standards Metrology and Inspection (BSMI) - Taiwan
- Infocomm Development Authority (IDA) - Singapore
- Korea Communications Commission (KCC) - Korea
- UL Recognized Component (UL294)

### Singapore

Complies with  
IMDA Standards  
DB106440