



R1612T

v.1.0

R 12V/16x1,5A/TOPIC

RACK mounted power supply for up to 16 HD cameras.

EN**

Edition: 2 from 10.04.2017

Supersedes the edition: 1 from 28.01.2016



Features:

- DC 12V/16x0,87A uninterruptible power supply for powering HD cameras ($\Sigma I = 14A$ max.)
- the adjustment of output voltage in the range 12V÷15V DC available from the front panel of the power supply unit
- 16 outputs independently protected by 1,5A melting fuses
- wide range of mains supply AC: 176÷264V AC
- high efficiency 80%
- LED optical indication: AC, DC, TEMP, LoB, ALARM, AUX1 ÷ AUX16
- acoustic indication of failure
- control of voltage presence at the AUX1 ÷ AUX16 outputs
- the ALARM technical output of collective failure –relay type, activated by:
 - 230V AC power loss
 - activation of the output fuse in the camera power supply circuit
 - too high temperature of the PSU (>70°C)
 - the PSU failure
- protections:
 - SCP short-circuit protection
 - OVP overvoltage protection
 - overvoltage protection
 - overload protection OLP
- forced cooling (fan)
- warranty – 2 year from the production date

Sample application of the RACK power supply unit.

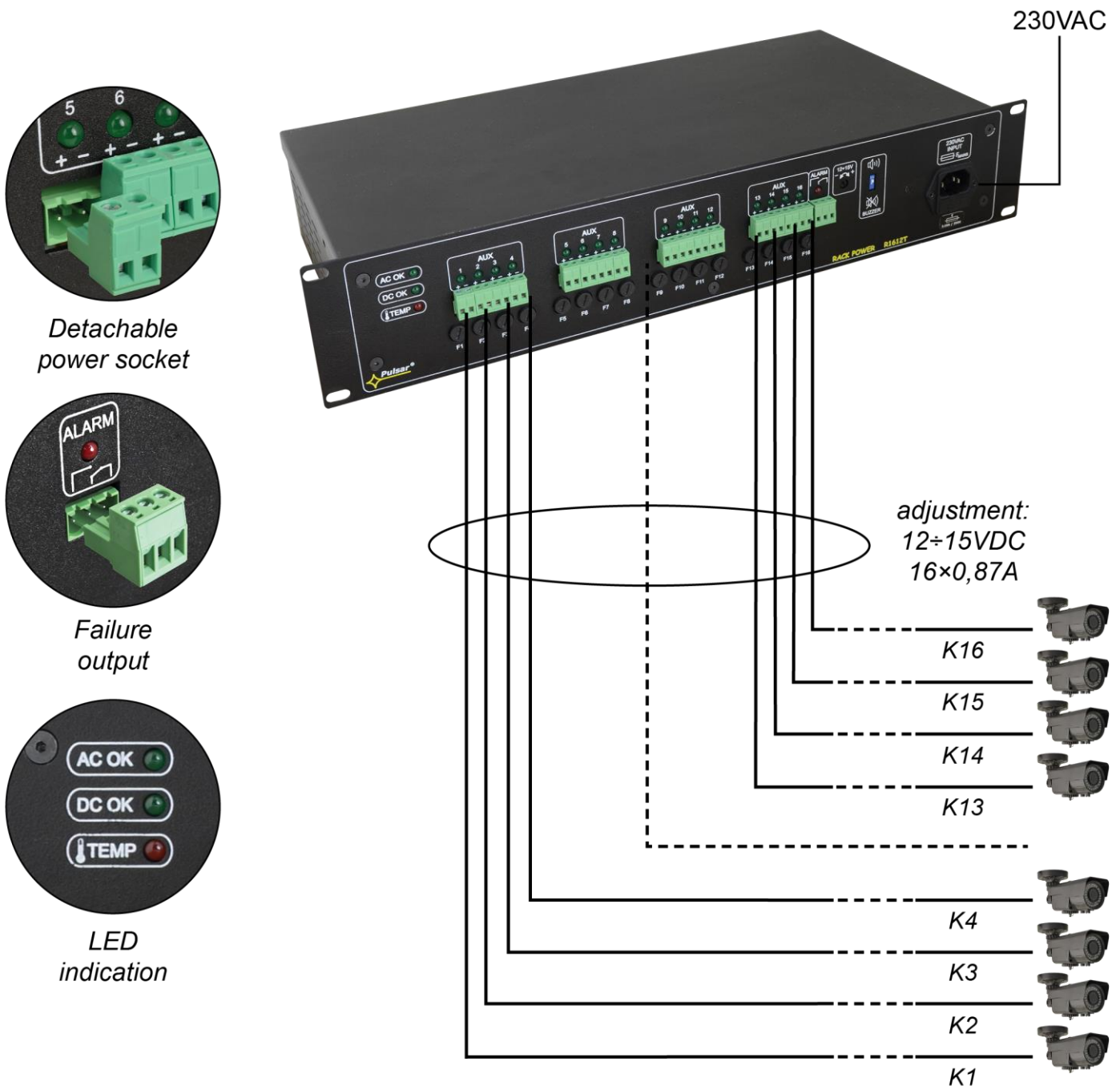

CONTENTS:

- 1. Technical description.
 - 1.1. General description
 - 1.2. Block diagram
 - 1.3. Description of PSU components and connectors
 - 1.4. Specifications
- 2. Installation.
 - 2.1. Requirements
 - 2.2. Installation procedure
- 3. Operating status indication.
 - 3.1. LED indication
 - 3.2. Technical output
 - 3.3. Acoustic indication
- 4. Operation and use.
 - 4.1. Overload or short circuit of the PSU output
 - 4.2. Maintenance

1. Technical description.

1.1. General description.

The **R1612T** power supply unit is designed for uninterrupted power supply of up to 16 HD cameras requiring stabilized voltage of **12V DC** with the total current efficiency of **14A**. The output voltage adjustment range is adjusted via a potentiometer within the range of **12V÷15V DC**. The PSU is fitted with 16 outputs protected independently with melting fuse 1,5A. The power supply is fitted with the **ALARM** output of collective failure. In case of failure, relay contacts are switched automatically, which is accompanied by acoustic and optical indication (the corresponding led goes on). The power supply construction is based on the switch mode PSU with high energy efficiency and is located in an enclosure adapted for mounting in standard **RACK 19"** cabinets.

1.2. Block diagram.

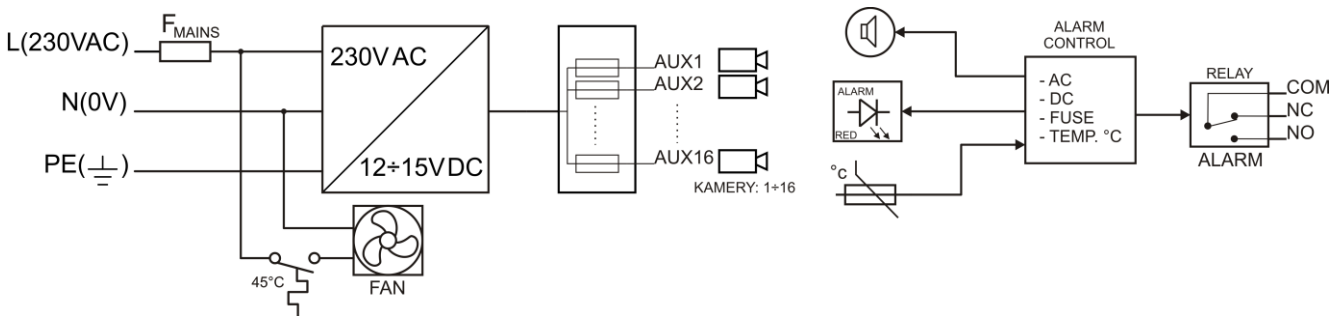



Fig.1. The block diagram of the PSU.

1.3. Description of PSU components and connectors.

Table 1. Components of the front panel of the power supply.

| Element no. [Fig. 2] | Description |
|-------------------------|--|
| ① | AC OK – green LED, indicating the presence of 230V voltage |
| ② | DC OK – green LED, indicating the presence of DC voltage |
| ③ | TEMP – red LED, indicating too high temperature of the power supply (>70°C) |
| ④ | Green LED AUX1 ÷ AUX16 – voltage indication at the outputs AUX |
| ⑤ | LED ALARM – red LED failure indication |
| ⑥ | AUX1 ÷ AUX16 – independently protected outputs |
| ⑦ | ALARM – technical output of collective failure – relay |
| ⑧ | Potentiometer , output voltage adjustment within the range of 12V÷15V DC |
| ⑨ | BUZZER, micro switch , turning ON / OFF of acoustic indication  switch in the top position, indication ON |

| | |
|---|---|
| |  switch in the down position, indication OFF |
| ⑩ | 230V AC INPUT , power socket 230V AC, power cable 1,5m included |
| ⑪ | F_{MAINS} , fuse in the supply circuit 230V AC, T 3,15A/250V |
| ⑫ | F1 ÷ F16 , melting fuses in the camera power supply circuits AUX (+), F1,5A |

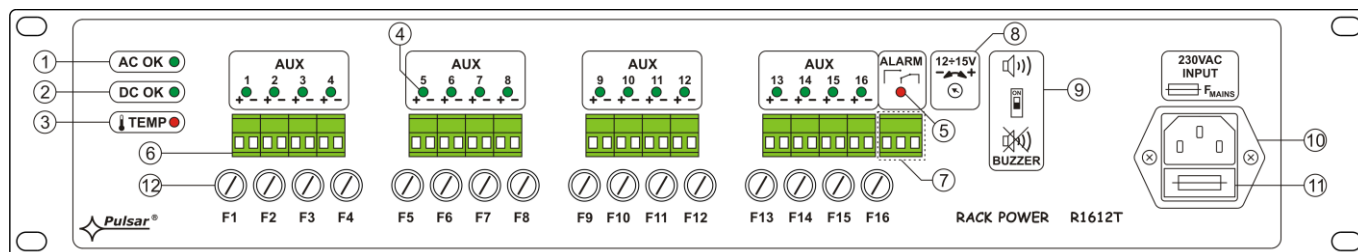

Fig. 2. The front power of the power supply unit.

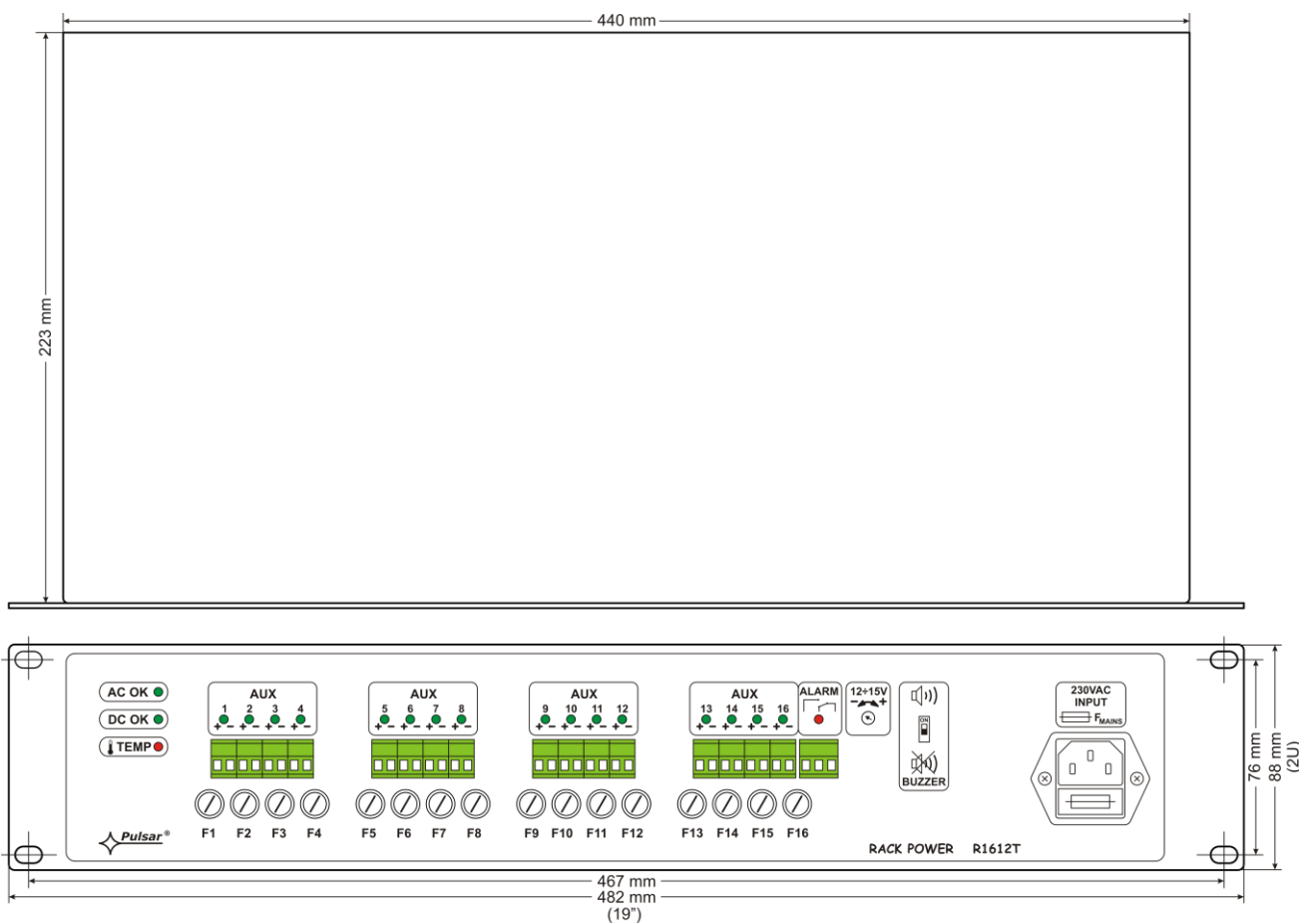

Fig.3. The view of the PSU.

1.4. Specifications.

- electrical parameters (tab.2)
- mechanical parameters (tab.3)
- operation safety (tab.4)
- operating parameters (tab.5)

Electrical parameters (tab. 2).

| | |
|--|---|
| Mains supply | 176÷264V AC |
| Current up to | 1,6A@230V AC max. |
| Supply power | 168W max. |
| Efficiency | 80% |
| Output voltage | 12V DC |
| Voltage adjustment range output | 12÷15V DC |
| Output current | 16 x 0,87A ($\Sigma I = 14A$) max. @12V |
| Ripple | 100 mV p-p max. |
| Short-circuit protection SCP | 16 x F 1,5A melting fuse |
| Overload protection OLP | 105% ÷ 150% of the PSU power, automatic return |
| Overvoltage protection OVP | >16V (automatic recovery) |
| Surge protection | varistors |
| Optical indication of operation: | LED: AC, DC, TEMP, LoB, ALARM, AUX1÷AUX16 |
| Acoustic operation indication: | Piezoelectric indicator ~75dB/0,3m |
| The ALARM technical output of collective failure | Relay type: 1A@ 30VDC/50VAC |
| The F_{MAINS} fuse in the 230V power supply circuit | T 3,15A |
| F1÷F16 fuses in the camera power supply circuits AUX(+) | F 1,5A |

Mechanical parameters (tab. 3).

| | |
|----------------------|---|
| Enclosure dimensions | W=19", H=2U; 482 x 88 x 223 mm (WxHxD) |
| Fixation | four-point butt mounting to RACK profiles – the set include 4 M6 screws + cage nuts |
| Net weight | 5,6kg / 6kg |
| Enclosure | Steel plate RAL 9005, black |
| Connectors | 230V AC input: the IEC C14 socket with a fuse, power cable 1,5m (included) Outputs: ALARM, AUX1÷AUX16: $\Phi 0,5-2,1$ (AWG 24-12) 0,5-2mm ² |
| Notes | Forced cooling (fan) |

Operation safety (tab.4).

| | |
|---|---|
| Protection class PN-EN 60950-1:2007 | I (first) |
| Protection grade PN-EN 60529: 2002 (U) | IP20 |
| Electrical strength of insulation: - between input and output circuits of the PSU (I/P-O/P) - between input circuit and PE protection circuit (I/P-FG) - between output circuit and PE protection circuit (O/P-FG) | 3000 V/AC min. 1500 V/AC min. 500 V/AC min. |
| Insulation resistance: - between input circuit and output or protection circuit | 100 M Ω , 500V/DC |

Operating parameters (tab.5).

| | |
|---|---------------------------------|
| Environmental class | II |
| Operating temperature | -10°C...+45°C |
| Storage temperature | -20°C...+60°C |
| Relative humidity | 20%...90%, without condensation |
| Vibrations during operation | unacceptable |
| Impulse waves during operation | unacceptable |
| Direct insulation | unacceptable |
| Vibrations and impulse waves during transport | According to PN-83/T-42106 |

2. Installation.

2.1. Requirements.

The PSU RACK shall be mounted by a qualified installer with appropriate permissions and qualifications for 230V/AC installations and low-voltage installations (required and necessary for a given country). The device shall be mounted in confined spaces, according to the environment class II, with normal air humidity (RH=90% max. without condensation) and the temperature from -10°C do +45°C.



During normal operation the total current consumption of the receivers cannot exceed I=14A.

As the PSU is designed for a continuous operation and is not equipped with a power-switch, therefore an appropriate overload protection shall be guaranteed in the power supply circuit. Moreover, the user shall be informed about the method of unplugging (usually through assigning an appropriate fuse in the fuse-box). The electrical system shall follow valid standards and regulations.

2.2. Installation procedure.

- 1. Before installation, cut off the voltage in the 230V power-supply circuit.
- 2. Mount the power supply in a RACK 19" cabinet as shown below:



- Mount M6 cage nuts



- Secure the enclosure with 4xM6 screws

- 3. Connect the receivers' cables to the terminals AUX1...AUX16.
- 4. If needed, the following technical connections can be made:
 - ALARM – technical output of collective failure
- 5. Connect the ~230V AC power cord with the IEC C13 plug (included) to the 230V AC power supply and turn on the power (~230V).
- 6. In the case of an unsafe voltage supply with frequent voltage drops in effective resistance of receiver supply cables can occur, it is possible to adjust the output voltage using the potentiometer (12V±15V DC) at the front panel of the power supply.
- 7. Check the PSU operation indicator.

3. Operating status indication.

3.1. LED indication.

The PSU has 20 LED lights at the front panel:



- GREEN LED:
- on – the PSU is supplied with 230V AC
 - off – no 230V AC supply



- GREEN LED:
- on – DC voltage at the output of the switch mode PSU
 - off – no DC voltage at the output of the switch mode PSU



- RED LED:
- on – failure
 - off – no failure



- RED LED:
- ON – too high temperature of the switch mode power supply (>70°C)
 - OFF – standard temperature of the switch mode power supply

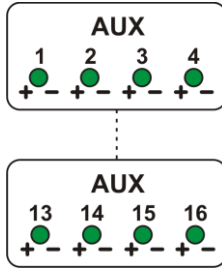

GREEN LED:

- on – DC voltage in the AUX1...AUX16 output
- off – no DC voltage in the AUX1...AUX16 output

3.2. Technical output.

The power supply is fitted with the **ALARM** output of collective failure (relay type). A collective failure can be triggered by the following events:

- 230V AC mains power failure
- Melting fuse activation F1÷F16
- Failure of the switch mode power supply
- Too high temperature of the switch mode power supply (>70°C)

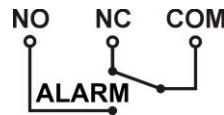

Fig. 4. Electrical diagram of the ALARM collective output of failure.



CAUTION! In Fig.4 the set of contacts shows a potential-free status of the relay, which corresponds to power supply failure.

3.3. Acoustic indication.

A collective failure is indicated by the piezoelectric indicator, 1 beep every second. The acoustic indication can be turned off by changing the ON / OFF position of the switch »)).



switch in the up position, indication ON

switch in the down position, indication OFF

4. Operation and use.

4.1. Overload or short circuit of the PSU output.

The AUX1 ÷ AUX16 power supply outputs are protected against short circuit by melting fuses; in the case of fuse failure, it should be replaced with a fuse of the same type.

4.2. Maintenance.

Any and all maintenance operations may be performed following the disconnection of the PSU from the power supply network. The PSU does not require performing any specific maintenance measures. In case of fuse replacement, use a replacement of the same parameters.



WEEE LABEL

Waste electrical and electronic equipment must not be disposed of with normal household waste. According to the European Union WEEE Directive, waste electrical and electronic equipment should be disposed of separately from normal household waste.

Pulsar

Siedlec 150, 32-744 Łapczyca, Poland
Tel. (+48) 14-610-19-40, Fax. (+48) 14-610-19-50
E-mail: biuro@pulsar.pl, sales@pulsar.pl
http:// www.pulsar.pl, www.zasilacze.pl