









# TruVision NVR 22 (S/P) User Manual

<b>Copyright</b>	© 2016 United Technologies Corporation. All rights reserved.
	Interlogix is part of UTC Climate, Controls & Security, a unit of United Technologies Corporation. All rights reserved
<b>Trademarks and patents</b>	Trade names used in this document may be trademarks or registered trademarks of the manufacturers or vendors of the respective products.
<b>Manufacturer</b>	Interlogix 2955 Red Hill Avenue, Costa Mesa, CA 92626-5923, USA
	Authorized EU manufacturing representative: UTC Fire & Security B.V. Kelvinstraat 7, 6003 DH Weert, The Netherlands
<b>FCC compliance</b>	<b>Class A:</b> This equipment has been tested and found to comply with the limits for a Class A digital device, pursuant to part 15 of the FCC Rules. These limits are designed to provide reasonable protection against harmful interference when the equipment is operated in a commercial environment. This equipment generates, uses, and can radiate radio frequency energy and, if not installed and used in accordance with the instruction manual, may cause harmful interference to radio communications. Operation of this equipment in a residential area is likely to cause harmful interference in which case the user will be required to correct the interference at his own expense.
<b>FCC conditions</b>	This device complies with Part 15 of the FCC Rules. Operation is subject to the following two conditions:
	(1) This device may not cause harmful interference. (2) This Device must accept any interference received, including interference that may cause undesired operation.
<b>Canada</b>	This Class A digital apparatus complies with CAN ICES-003 (A)/NMB-3 (A). Cet appareil numérique de la classe A est conforme à la norme CAN ICES-003 (A)/NMB-3 (A).
<b>ACMA compliance</b>	<b>Notice!</b> This is a Class A product. In a domestic environment this product may cause radio interference in which case the user may be required to take adequate measures.
<b>Certification</b>	  
<b>EU directives</b>	This product and - if applicable - the supplied accessories too are marked with "CE" and comply therefore with the applicable harmonized European standards listed under the EMC Directive 2014/30/EU, the RoHS Directive 2011/65/EU.
	 
	<b>2012/19/EU (WEEE directive):</b> Products marked with this symbol cannot be disposed of as unsorted municipal waste in the European Union. For proper recycling, return this product to your local supplier upon the purchase of equivalent new equipment, or dispose of it at designated collection points. For more information see: <a href="http://www.recyclethis.info">www.recyclethis.info</a> .
	
	<b>2013/56/EU &amp; 2006/66/EC (battery directive):</b> This product contains a battery that cannot be disposed of as unsorted municipal waste in the European Union. See the product documentation for specific battery information. The battery is marked with this symbol, which may include lettering to indicate cadmium (Cd), lead (Pb), or mercury (Hg). For proper recycling, return the battery to your supplier or to a designated collection point. For more information see: <a href="http://www.recyclethis.info">www.recyclethis.info</a> .
<b>Contact information</b>	For contact information, see <a href="http://www.interlogix.com">www.interlogix.com</a> or <a href="http://www.utcssecurityproducts.eu">www.utcssecurityproducts.eu</a>

# Content

<b>Chapter 1</b>	<b>Product introduction 1</b>
	Product overview 1
	Default settings to access the device 1
<b>Chapter 2</b>	<b>Physical installation 3</b>
	Installation environment 3
	Unpacking the recorder and its accessories 3
	Back panel 4
	RS-232 port 6
	PoE ports 6
	Monitor connections 6
	Rack mounting 6
<b>Chapter 3</b>	<b>Getting started 7</b>
	Powering on the recorder 7
	The startup wizard 8
<b>Chapter 4</b>	<b>Operating instructions 10</b>
	Controlling the recorder 10
	Using the front panel 10
	Using the mouse 14
	Using the IR remote control 15
	Menu overview 17
<b>Chapter 5</b>	<b>Live view 21</b>
	Description of live view 21
	Video output 22
	Live view mouse menu 22
	Single and multiview display mode 23
	Sequencing cameras 24
	Live view toolbar 24
	Digital zoom 25
	PTZ preset and tours 26
<b>Chapter 6</b>	<b>Searching files 29</b>
	Advanced search video menu 29
	Search and play back recordings by time and video type 30
	Search and play back recordings by event 31
	Search bookmarked recordings 31
	Search snapshots 32
	Log search 33
<b>Chapter 7</b>	<b>Playback functionality 34</b>
	Instant playback 37

	24-hour playback	38
	Event playback	39
	Smart playback	40
	Split-screen playback	42
	Playback speed and skip time	43
	Play back frame-by-frame	44
	Digital zoom in playback	44
	Create bookmarks	45
	Lock playback files	45
	Manage playback files	46
<b>Chapter 8</b>	<b>Archiving files</b>	<b>47</b>
	Archiving files	47
	Create and archive video clips	50
	Playing back archived files on a PC	50
	Using TruVision Player	51
<b>Chapter 9</b>	<b>Display settings</b>	<b>52</b>
	Display settings	52
	Layout	54
<b>Chapter 10</b>	<b>Camera setup</b>	<b>56</b>
	IP camera status	56
	Using RTSP custom protocols	58
	PoE power budget (TVN 22S only)	58
	Camera recording settings	60
	Snapshots	61
	Camera OSD	62
	Image settings	63
	Motion detection	64
	Privacy mask	65
	Camera tamper	66
	VCA setup	67
	PTZ presets and tours	68
	V-stream encoding	72
	People counting	72
<b>Chapter 11</b>	<b>Network settings</b>	<b>74</b>
	Network settings	74
	PPPoE settings	76
	DDNS settings	77
	NTP server settings	78
	Email settings	79
	Configure an FTP server to store snapshots	80
	SNMP settings	80
	UPnP settings	81
	Network status	81
	Archive network packet data	82

	Network statistics	83
	Port forwarding	83
<b>Chapter 12</b>	<b>Recording</b>	<b>84</b>
	Recording schedule	84
	Modify the instant playback duration	87
	Manual recording	87
	Hot Spare	88
	SD card recording	89
<b>Chapter 13</b>	<b>Alarm and event setup</b>	<b>91</b>
	Set up alarm inputs	91
	Alarm response actions	92
	Set up alarm outputs	93
	Manual trigger	94
	Alarm Audio	94
	Event notifications	95
	Detect video loss	97
	Alarm host setup	98
	OH alarm reporting	99
	TVRMobile push notifications	103
<b>Chapter 14</b>	<b>Device management</b>	<b>105</b>
	Time and date settings	105
	General recorder settings	107
	Configuration files	108
	Upgrade system firmware	109
	Holiday schedules	109
	RS-232 settings	110
	Using a network storage system	110
<b>Chapter 15</b>	<b>Storage management</b>	<b>112</b>
	HDD information	112
	Storage mode	114
	Managing eSATA	116
	S.M.A.R.T. settings	116
	Bad sector detection	117
	RAID	118
<b>Chapter 16</b>	<b>User management</b>	<b>121</b>
	Add a new user	121
	Customize a user's access privileges	122
	Delete a user	124
	Modify a user	124
	Change the Admin password	125
<b>Chapter 17</b>	<b>System information</b>	<b>126</b>
	View system information	126

	Search the system log	129
<b>Chapter 18</b>	<b>Using the web browser</b>	<b>132</b>
	Internet Explorer users	132
	Access the web browser	133
	HTTPS settings	133
	Mac Safari Browser users	135
	Plug-in installation	135
	Web browser live view	137
	Control a PTZ dome camera via the web browser	139
	Play back recorded video	140
	Search for event logs	141
	Recording from the browser	142
	Configure the recorder via the browser	142
<b>Appendix A</b>	<b>Specifications</b>	<b>146</b>
<b>Appendix B</b>	<b>Port forwarding information</b>	<b>149</b>
	Seeking further assistance	149
<b>Appendix C</b>	<b>Maximum pre-recording times</b>	<b>151</b>
<b>Appendix D</b>	<b>Default menu settings</b>	<b>153</b>
	<b>Index</b>	<b>166</b>

# Chapter 1

## Product introduction

### Product overview

The TruVision NVR 22 (TVN 22) series is a versatile, user-friendly embedded network video recorder (NVR) series. The standard series supports up to 8, 16 or 32 channels and up to 4 SATA hard drives.

The TVN 22S model includes an 8 or 16 channels version and an embedded PoE switch that allows TruVision cameras to be connected in a plug and play manner. Simply plug in the IP camera to automatically power and connect it, assign the IP address, as well as set it up using default values. The embedded 8/16 PoE switch provides a maximum PoE wattage of respectively 120 W and 200 W.

The TVN 22P series supports 16 or 32 channels (16, 32 or 64 channels in EMEA only) and up to 8 SATA hard drives. The full TVN 22 series provides integration with the UTC portfolio of security solutions, and offers a seamless user experience within the TruVision brand.

The TVN 22 series can be configured and operated through its on-screen display (OSD), web browser, mobile applications, TruVision Navigator software, or third party software using the TruVision SDK.

The recorder can be fully managed by the license-free TruVision Navigator software - ideal for most commercial applications. It's easy and intuitive web browser interface enables remote configuration, viewing and searching of video on any TruVision recorders.

### Default settings to access the device

#### Default user names and passwords

See Table 1 on page 2 for the list of default user names and passwords. Go to Chapter 16 "User management" on page 121 for further information.

**Table 1: Default user names and passwords**

<b>User</b>	<b>Description</b>
<b>Administrator</b>	There can only be one administrator. The user name is "admin". The name cannot be modified. The default password is 1234.
<b>Operator</b>	The default user name is "operator." The default password is 2222.
<b>Guest</b>	The default user name is "guest." The default password is 3333.

**Note:** The default passwords should be changed for security reasons.

### Default network settings

The network settings are:

- IP address - 192.168.1.82
- Subnet mask - 255.255.255.0
- Gateway address - 192.168.1.1
- Ports:

When using the browser:

RTSP port: 554

HTTP port: 80

When using TruNav:

RTSP port: 554

Server/Client software port: 8000

Go to "Using the web browser" on page 132 for further information.



# Chapter 2

## Physical installation

This section describes how to install the recorder.

### Installation environment

When installing your product, consider these factors:

- Ventilation
- Temperature
- Moisture
- Chassis load

**Ventilation:** Do not block any ventilation openings. Install in accordance with the manufacturer's instructions. Ensure that the location planned for the installation of the unit is well ventilated.

**Temperature:** Consider the unit's operating temperature (-10 to +55 °C, 14 to 131 °F) and noncondensing humidity specifications (10 to 90%) before choosing an installation location. Extremes of heat or cold beyond the specified operating temperature limits may reduce the life expectancy of the recorder. Do not install the unit on top of other hot equipment. Leave 44 mm (1.75 in.) of space between rack-mounted DVR units.

**Moisture:** Do not use the unit near water. Moisture can damage the internal components. To reduce the risk of fire or electric shock, do not expose this unit to rain or moisture.

**Chassis:** Equipment weighing less than 15.9 kg (35 lb.) may be placed on top of the unit.

### Unpacking the recorder and its accessories

When you receive the product, check the package and contents for damage, and verify that all items are included. There is an item list included in the package. If any of the items are damaged or missing, please contact your local supplier.

Items shipped with the product include:

- IR (infrared) remote control
- Two AAA batteries for the remote control
- AC power cords
- USB mouse
- Brackets
- Recorder
- Hard Drive Kits
- CD with software and manuals
- *TruVision NVR 22 Quick Start Guide*
- *TruVision NVR 22 (SP) User Manual (on CD)*
- *TruVision Recorder Operator Guide (on CD)*

## Back panel

The figures below show the back panel connections and describe each connector on a typical TVN 22 digital video recorder. Details may vary for specific models.

Before powering up the recorder, insert the hard drives and connect a main monitor for basic operation. Once all required connections are done, enter the relevant data in the setup wizard (see page 8).

**Note:** For every hardwired alarm input, connect one wire to the input connection with the alarm number label and one wire to a ground connection (labeled G).

Figure 1: TVN 22 back panel connections

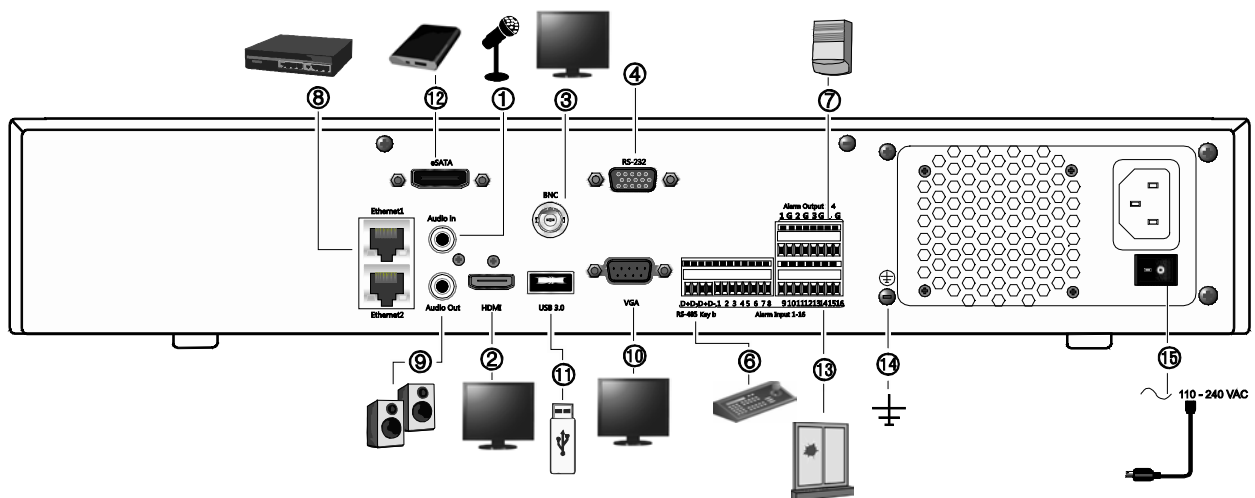

Figure 1: TVN 22P back panel connections

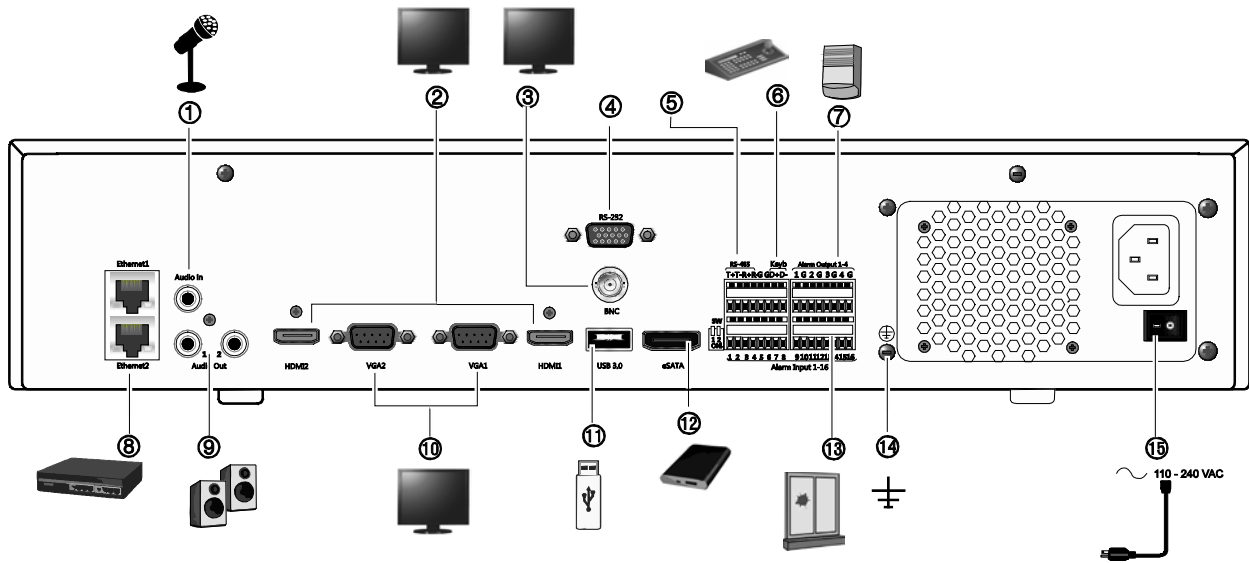
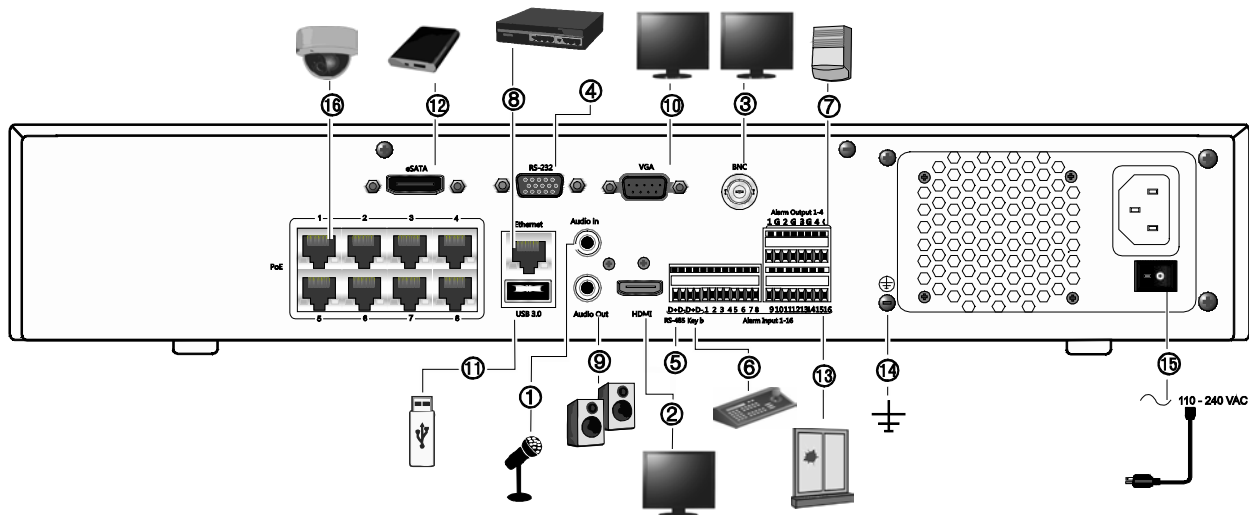

Figure 2: TVN 22S back panel connections



1. Connect one audio input to RCA connectors.
2. Connect to an HDTV. The HDMI connection supports both digital audio and video.
3. Connect one CCTV monitor (BNC-type connectors).
4. Connect to a RS-232 device.
5. RS-485 port not used.
6. Connect to a keypad via RS-485 (KTD-405 shown).
7. Connect up to four alarm relay outputs.
8. Connect to a network (RJ45).
9. Connect to speakers for audio output.
10. Connect to a VGA monitor.
11. Universal Serial Bus (USB). Connect to an additional device such as a USB mouse, CD/DVD burner, or USB HDD.
12. Connect to an optional eSATA device such as SATA HDD, CD/DVD-RM.
13. Connect up to 16 alarm inputs (depending on model).
14. Connect to ground.
15. Connect to a power cord. Use the power switch to turn on/off the unit.
16. 8/16 PoE ports (depending on model). (TVN 22S only)

## RS-232 port

Use the RS-232 port to connect text interface devices or for use by technical support.

## PoE ports

Connect up to 8 or 16 IP cameras to the embedded PoE ports depending on the TVN 22 model.

## Monitor connections

The recorder supports up to 1280 × 1024 / 60 Hz resolution in VGA and 4K resolution in HDMI. The monitor resolution should be at least 800 × 600. Adjust your monitor accordingly to this resolution.

The VGA or HDMI monitor can be used as the main monitor of the recorder. The BNC video output can be used as event or alarm monitor.

## Rack mounting

The TVN 22 and 22S have a 1.5U desk based chassis. The TVN 22P has a 2U desk based chassis. Both can be easily rack-mountable with the purchase of the TVR-RK-1 rack-mount kit. Contact your local supplier to order the kit. See Figure 3 below.

Figure 3: TVN 22S rack-mount installation

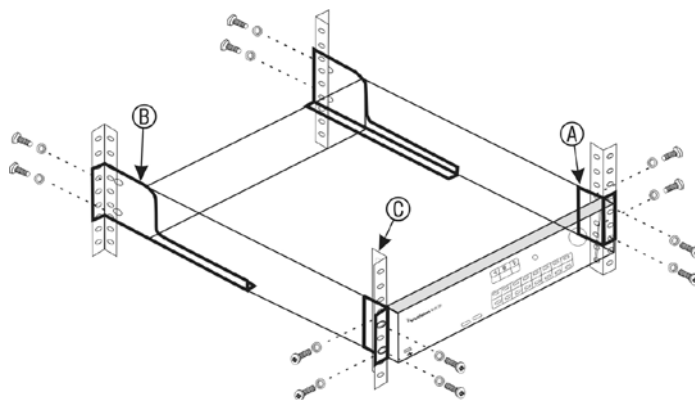

### To install the racks:

1. Attach the two small front-rack mount ears (A) to the NVR. The screws are supplied.
2. Attach the two large rear support brackets (not supplied) to the rear rails (B).
3. Attach the NVR to the front rails (C). The screws are not supplied.

# Chapter 3

## Getting started

### Powering on the recorder

Before starting the recorder, connect at least one monitor (HDMI or VGA). Otherwise, you will not be able to see the user interface and operate the device.

The recorder auto-detects the video mode (PAL or NTSC) on startup.

It comes equipped with a universal power supply that will auto-sense 110/240 V, 60/50 Hz.

**Note:** It is recommended that an uninterruptible power supply (UPS) is used in conjunction with the device.

#### To turn on the recorder:

Turn on the recorder using the power switch on the back panel. Once it is powered up, the status LEDs on the front panel will light up.

#### To turn off the recorder:

1. In live view mode, right-click the mouse and click **Menu > Shutdown**.
2. In the Shutdown popup menu, select **Shutdown**. Click **Yes** to confirm shutdown.

You will be requested to enter the Admin password.

#### To reboot the recorder:

1. In live view mode, right-click the mouse and click **Menu > Shutdown**.
2. In the Shutdown popup menu, select **Reboot**. Click **Yes** to confirm reboot.

You will be requested to enter the Admin password.

## The startup wizard

The recorder has an express installation wizard that lets you easily configure basic recorder settings when first used. It configures all cameras to default settings. The configuration of each camera and recorder can be customized as required.

By default the startup wizard will start once the recorder has loaded. It will walk you through some of the more important settings of your recorder.

Any changes you make to a setup configuration page are saved when you exit the page and return to the main wizard page.

**Note:** If you want to set up the recorder with default settings only, click **Next** in each screen until the end.

### To use the Startup wizard:

1. To launch the startup wizard without rebooting the device, go to **Menu > Device Management > General Settings** and click 'Start wizard'.
2. Select the preferred language for the system and resolution from the drop-down list and then click **Next**.
3. Enable or disable the option to start the wizard automatically when the recorder is turned on. Click **Next**.
4. In each setup configuration page, enter the desired information and then click **Next** to move to the next page. The setup configuration pages are:

Wizard setup pages	Description
User configuration	<p>You can change the admin password and create additional users. You must enter an admin password.</p> <p>The default admin password is 1234.</p> <p>Caution: It is strongly recommended that you change the password of the administrator. Do not leave 1234 as the default password. Write it down in a safe place so that you do not forget it. If you should forget the password to your recorder, contact your supplier with the serial number of your recorder to obtain a secure code to reset it.</p>
Time and date configuration	<p>Select the desired time zone, date format, system time, and system date.</p> <p>If Daylight saving time (DST) is required, check <b>Enable DST</b> and enter the desired summer and winter times.</p> <p><b>Note:</b> The system time and date are visible on screen. However, they do not appear in recordings.</p>
Network configuration	<p>Configure your network settings such as the NIC type, IP address, subnet mask, and default gateway. Enter the preferred DNS server address as well as the alternate one to use.</p>
HDD management	<p>The hard drives are initialized at the factory. However if you wish to clear all data, click <b>Initialize</b> to initialize the HDD.</p>

Wizard setup pages	Description
Adding IP cameras	<p>You do not need to search for TruVision PoE cameras. They are automatically recognized when plugged in.</p> <p>Click <b>Search</b> to find any available IP cameras on the LAN.</p> <p>There are two ways to add an IP camera to the recorder system:</p> <p><i>Manually:</i> Enter the IP address of the IP camera to be added. Select the appropriate protocol, stream number, and management port and then enter User name and Admin password, and then click the <b>Add</b> button. Click, <b>Next</b> to move to the next page.</p> <p><i>Automatically:</i> Select the desired IP cameras from the search results list. Click <b>Quick Add</b> to add the selected cameras to the recorder system without modifying the camera configuration. The search list will display all supported IP cameras that are located on the LAN.</p>
Recording	<p>Configure your default recording settings as required. The settings apply to all cameras connected to the recorder.</p> <p>Check the <b>Constant Recording</b> checkbox for the recorder to record continuously all day. If left unchecked, the recorder will not record.</p> <p>Check the desired time lapse check box, <b>TL-Hi</b> or <b>TL-Lo</b>.</p> <p>To record motion detection events, check <b>Event (Motion)</b>.</p> <p>To record alarm events, check <b>Alarm</b>.</p> <p><b>Note:</b> You can configure the recording parameters of each individual camera for the different recording schedules in the recording menu.</p>

- When all the required changes have been entered, a summary page appears showing all the settings.

Click **Finish** to exit the Wizard. The recorder is now ready to use.

For a description of the recorder main menu, see “Menu overview” on page 17.

---

**Important!** Your TruVision device is delivered with default user name and password credentials for initial access, easy configuration, and auto discovery. For security reasons, it is highly recommended to change the default credentials.

---

# Chapter 4

## Operating instructions

### Controlling the recorder

There are several ways to control the recorder:

- Front panel control. See “Using the front panel” below.
- Mouse control. See “Using the mouse” on page 14.
- IR remote control. See “Using the IR remote control” on page 15.
- TVK-800 keypad (from TVK-800 firmware version 1.0i). Please refer to the user manual for more information.

**Note:** The TVK-800 keypad cannot decode H.265 cameras.

- Web browser control. See Chapter 18 “Using the web browser” on page 132 for more information on using the web browser.
- Software (TruVision Navigator, TVRmobile or other video management or integration software platforms). Please refer to the relevant user manuals of the individual software platforms for more information.

You can use your preferred control method for any procedure, but in most cases we describe procedures using the mouse. Optional control methods are given only when they differ substantially from the mouse control methods.

### Using the front panel

The function buttons on the front panel control can be used to operate most, but not all, of the main functions of the recorder. The LED indicators light up to alert you of various conditions. The functions available can be limited by setting passwords. See Figure 9 on page 11 for more information.



**Figure 4: Front panel**

8-channel model:

















The controls on the front panel include:

**Note:** See Table 3 on page 13 for a detailed description of all these buttons for different tasks.

**Table 2: Front panel elements**

Name	Description
1. Channel buttons	Switch between different cameras in live, PTZ control or playback modes.  Use the soft keyboard to enter numerals 0 to 9.
2. Display buttons	<p><b>F1:</b> In Playback mode, click to start and stop video clipping. For audio, press F1 and a numerical button to play the audio of the specified camera in live view.</p> <p>In System Information mode, get the DDNS URL. In User Management mode, pop up the Permission screen of a selected item in User Management &gt; User &gt; User Management. Delete a selected item from USB flash drive. Exit the virtual keypad.</p> <p><b>F2:</b> In live view mode, 24-hour playback, and playback modes press to display or hide the time or control bar. In PTZ mode, stop all ongoing operations. Select or deselect an item. Enter a selected folder of the external storage device, such as a USB flash drive used for archiving.</p> <p><b>A:</b> In Live View mode, select the main monitor.</p> <p><b>B:</b> In Live View mode, select the event monitor.</p> <p><b>Display:</b> In multiview mode, toggle through the various multiviews (full, quad, 1+5, 1+7, 9, and 16).  In HDD information mode and user management mode delete a selected item. In PTZ mode, delete a selected key point. In Log Search mode, display the details of a log file in Log Search result.</p>

Name	Description
3. Menu and Search buttons	 <b>Seq:</b> In Live View mode, start/stop sequencing cameras on the current monitor.  <b>Menu:</b> Enter/exit the main menu.  <b>Search:</b> In live view, enter the advanced search menu.
4. IR receiver	Receiver for IR remote. To connect the remote control to the recorder, press the Device button, enter the device address, and press Enter. See Using the IR remote control on page 15 for more information.
5. Front panel lock	You can lock or unlock the front panel with a key.
6. Status LEDs	 <b>Power:</b> A flashing green light indicates the recorder is working correctly. Red indicates a fault.  <b>Event Alarm:</b> A steady red light indicates that there is a sensor Alarm In or another alarm such as motion or tampering. No light indicates that there is no alarm.  <b>HDD:</b> HDD indicator blinks red when data is being read from or written to the HDD. A steady red light indicates an HDD exception or error.  <b>Tx/Rx:</b> Flashing green indicates a normal network connection. No light indicates that it is not connected to a network.  <b>Technical Alarm:</b> A steady red light indicates that there is a technical alarm from the recorder. No light indicates that there is no alarm.
7. Playback buttons	 <b>Reverse:</b> In live view mode, use to play back the earliest video. In playback mode, playback a camera in the reverse direction.  <b>Pause:</b> In live <b>view</b> , freeze the last image of the live display for all active cameras displayed. In playback mode, stop playback.  <b>Play:</b> In live view mode, play 24-hour playback of the current camera (upper-left video tile if in multiview mode). In playback mode, play back a camera in the forward direction. In search mode, play back a selected video or view a snapshot. In PTZ mode, do an auto tour. <b>Live:</b> Switch to live view mode.  <b>Replay:</b> In playback mode, start playing the current file. Starts at the beginning of the file.
8. PTZ buttons	 <b>Zoom +/-:</b> In live view mode, playback mode, and PTZ control mode use this button to zoom in and out. Also use them to navigate within menus.  <b>Preset:</b> In PTZ Control mode, press Preset and a numeric button to call the specified preset. Also use to edit holiday mode, video search mode, HDD selection mode, user management mode, bookmark management, and bookmark search.

























Name	Description
	 <b>Tour:</b> In PTZ Control mode, press Tour and a numeric button to call the specified shadow tour. Also use to scroll between calendar months and to navigate in a text field.
9. Direction	 The DIRECTION buttons are used to navigate between different fields and items in menus.
Enter button	 The ENTER button is used to confirm selection in any of the menu modes.
10. Archive button	 Press once to enter quick archive mode. Press twice to start archiving. Indicator blinks green when data is being written to backup device.
11. USB Interfaces	Universal Serial Bus (USB) ports for additional devices such as a USB mouse, CD/DVD burner, and USB Hard Disk Drive (HDD).

Table 3: Front panel button functions by task

Task	Button	Button function
Live view mode		<b>Direction:</b> Press to cycle through channels.
		<b>Enter:</b> Press to show the PTZ control toolbar.
		<b>Reverse:</b> Press to play the earliest video file of the current camera (upper-left video tile if in multiview mode).
		<b>Pause:</b> Press to freeze the last image of the live display for all active cameras displayed.
		<b>Play:</b> Press to play 24-hour playback of the current camera (upper-left video tile if in multiview mode).
		<b>Live:</b> Press to switch to live view mode.
		<b>Seq:</b> Press to start/stop sequencing cameras on the current monitor. Hold the Seq button for three seconds to start and stop sequencing.
Playback mode		<b>Direction:</b> The left and right buttons are used to speed up and slow down recorded video (Single to 300X). The up and down buttons are used to jump recorded video forwards or backwards by 30 s.
		<b>Enter:</b> Press the button to pause the video. Press again to restart the video.  In single-frame Playback mode, press to advance the video by a single frame.
		<b>Reverse:</b> Press to play back a camera in reverse direction.  In Playback mode, play back a camera in the reverse direction.
		<b>Pause:</b> In Playback mode, stop playback.

Task	Button	Button function
		<b>Play:</b> In Playback mode, play back a camera in the forward direction.
Pause mode		<b>Direction:</b> The left and right buttons are used to jump recorded video forwards or backwards by one frame. The up and down buttons are used to jump recorded video forwards or backwards by one second.
PTZ control mode		<b>Direction:</b> Press to control the movement of the PTZ camera.
		<b>Zoom +/-:</b> Press to zoom in and out.
		<b>Preset:</b> Press Preset and a numeric button to call the specified preset.
		<b>Tour:</b> Press Tour and a numeric button to call the specified shadow tour.
		<b>Play:</b> Press to do an auto tour.
		<b>Display:</b> Press to delete a selected key point from the PTZ Setting > More Settings> Tour > Key Point list.
Menu navigation		<b>Direction:</b> Press to navigate between different fields and items in menus.
		<b>Menu:</b> Enter/exit the main menu.
		<b>Enter:</b> Press to confirm the selection in any of the menu modes

## Using the mouse

The USB mouse provided with the recorder can be used to operate all the functions of the unit, unlike the front panel which has limited functionality. It lets you navigate and make changes to settings in the user interface.

Connect the mouse to the recorder by plugging the mouse USB connector into the USB port on the back panel or the front panel. The mouse is immediately operational and the pointer should appear.

**Note:** Use a USB 2.0 (front panel) or 3.0 (back panel) mouse.

You can purchase a spare mouse by ordering part number TVR-MOUSE-1.

See Table 6 on page 15 for a description of the mouse buttons.

**Table 4: Mouse buttons**

Item	Description	
Left button	Single-click	<p><b>Live view:</b> Select a camera to display the live view toolbar.</p> <p><b>Menu:</b> Select a component of a menu, such as a button or an input field. This is similar to pressing the Enter button on the remote/front panel controls.</p>
	Double-click	<p><b>Live view:</b> Switch between single screen and multi-screen mode in live/ playback mode.</p>
	Click and Drag	<p><b>Live view:</b> Drag channel/time bar.</p> <p><b>PTZ control:</b> Adjust pan, tilt, and zoom.</p> <p><b>Tamperproof, privacy masking and motion detection functions:</b> Select the target area.</p> <p><b>Digital zoom-in:</b> Drag and select target area.</p>
Right button	Single-click	<p><b>Live view:</b> Display menu.</p> <p><b>Menu:</b> Exit the current menu and return to higher level.</p>
Scroll-wheel	Scroll Up	<p><b>Live view:</b> Return to the previous window.</p> <p><b>Menu:</b> Move the selection to the previous item.</p>
	Scroll Down	<p><b>Live view:</b> Move to the next window.</p> <p><b>Menu:</b> Move the selection to the next item.</p>

## Using the IR remote control

The recorder is supplied with an infrared (IR) remote control unit. Like the mouse, it can be used to operate all of the main functions of the unit.

You can program the IR remote control with a unique device ID address so that the controller will only be able to communicate with recorders with that address. No programming is necessary if using a single recorder.

The device ID address only applies when using a remote control and not when using a keypad.

You can purchase a replacement remote control by ordering part number TVR-REMOTE-1.

**Figure 5: IR remote control**

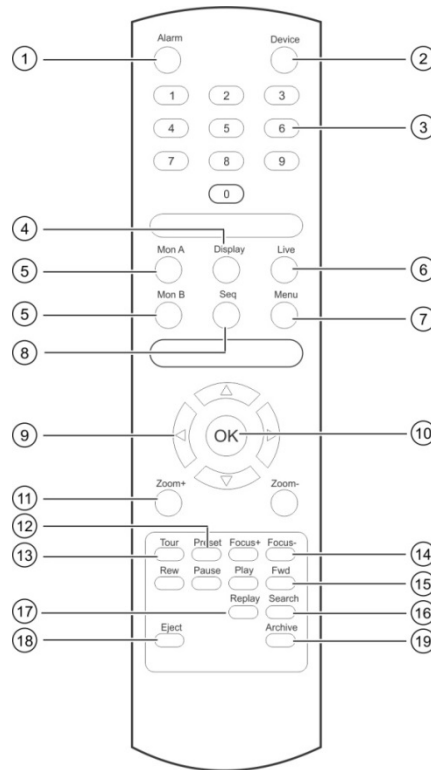

Item	Description
1. Alarm	Acknowledge an alarm.
2. Device	Enable/disable the IR remote control to control the recorder.
3. Numeric buttons	Select a camera, and enter a number in a menu option.
4. Display	Switch between the different multiview formats.
5. Mon A and Mon B	Switch between monitors A and B.
6. Live	Return to live view mode.
7. Menu	Activate the main menu.
8. Seq	Start /stop sequencing.
9. <, >, ^, v	In Menu mode: Use left or right arrow buttons to select and up or down arrow buttons to edit entry. In PTZ mode: Use to control PTZ. In Playback mode: Use to control playback speed.
10. OK	Confirm selection.
11. Zoom + and -	Use to control zoom of camera lens.
12. Preset	Enter preprogrammed three-digit code to call up a preset.
13. Tour	Enter preprogrammed three-digit code to call up shadow tour.
14. Focus + and -	Use to control focus of camera lens.
15. Playback control	Use to control playback (Rewind, Pause, Play, and Fast Forward).
16. Search	Open the Search menu.
17. Replay	Replay the selected file from the beginning.

Item	Description
18. Eject	Eject the CD or DVD disk.
19. Archive	Press once to enter quick archive mode. Press twice to start archiving.

Aim the remote control at the IR receiver located at the front of the unit to test operation.

#### To change the address of the remote control to the recorder:

1. Press the **Menu** button on the front panel or right-click the mouse and select the **Menu** button. The default display menu window appears.
2. Click **Device Management > General Settings**.
3. Check the remote control ID value. The default value is 255. This device address is valid for all IR controls.

**Note:** The recorder will respond to any remote control that has an address between 1 and 255.

4. On the remote control press the **Device** button.
5. Enter the device address value. It must be the same as that on the recorder.
6. Press the **OK** button on the remote control.

#### To place batteries into the IR remote control:

1. Remove the battery cover.
2. Insert the batteries. Make sure that the positive (+) and negative (-) poles are correctly placed.
3. Replace the battery cover.

## Troubleshooting the remote control

If the IR remote control is not functioning properly, perform the following tests:

- Check the battery polarity.
- Check the remaining charge in the batteries.
- Check that the IR remote control sensor is not masked.

If the problem still exists, please contact your administrator.

## Menu overview

The recorder has an intuitive structure that allows you to configure the unit's parameters quickly and efficiently. Each command icon displays a window that lets you edit a group of settings. Most menus are available only to system administrators.

The window is divided into three sections. The currently selected command icon and submenu item are highlighted in green. See Figure 6 below.

You must be in live view mode to access the main menu.

**Figure 6: Menu structure**









1. **Menu toolbar:** Setup options available for the selected menu function. Move the mouse over a command icon and click to select it. See Table 5 below for a description of the icons.
2. **Submenu panel:** Submenus for the selected menu function are displayed. Click an item to select it.
3. **Setup menu:** All the details for the selected submenu are displayed. Click a field to make changes.

**Note:** See Table 3 on page 11 for the description on how to access the menu options using the front panel.

**Table 5: Description of the menu toolbar icons**

Icon	Name	Description
	Display Settings	Configures display settings including video format, resolution, video output interface, dwell time, multiview format, and camera sequencing. See Chapter 9 “Display settings” on page 52.
	Camera Setup	Configures camera settings including snapshot resolution and quality, camera settings including OSD, privacy masking, tampering, motion detection setup, PTZ presets and shadow tours, V-stream encoding and people counting. See Chapter 10 “Camera setup” on page 56
	Network Settings	Configures standard network settings including IP address, email notifications, DDNS setup, and advanced network settings. See the Chapter 11 “Network settings” on page 74.
	Recording	Configures recording settings including instant playback duration, recording schedule, manual recording and hot spare. See Chapter 12 “Recording” on page 84.



Icon	Name	Description
	Alarm and Event Setup	Configures alarm settings including alarm input, alarm output, manual trigger, alarm notifications, video loss, alarm host setup, and intrusion panel and zone setup (OH integration). See Chapter 13 "Alarm and event setup" on page 91.
	Device Management	Configures system settings including system date and time, DST, language, menu timeout, import/export config files, firmware upgrade, holiday schedules and RS-232 settings. See Chapter 14 "Device management" on page 105.
	Storage Management	Configures HDD information, storage mode, S.M.A.R.T. settings, bad sector detection and RAID. See Chapter 15 "Storage management" on page 112.
	User Management	Configures users, passwords, and access privileges. See Chapter 16 "User management" on page 121.
	System Information	Displays device information, camera setup information, recording setup information, alarm inputs information, alarm outputs information, network information, HDD information, and log search. See Chapter 17 "System information" on page 126.
	Help	Provides reference information to the various toolbars, menus, and keys within the interface.
	Shutdown	Provides access to logout, reboot, and shutdown options. See "Powering on the recorder" on page 7.

### To access the main menu:

- In live view, press the **Menu** button on the remote control or front panel.  
- Or -  
Right-click the mouse and select **Menu** from the pop-up menu.  
The main menu window appears. The Display Settings window appears by default.
- Click the required menu icon to display its submenu options. Modify the configuration parameters as required.
- Click **Apply** to save the settings.
- Click **Exit** to leave the menu setup and return to live view.

### The soft keyboard

A keyboard will appear on-screen when you need to enter characters in a window option. Click a key to input that character.

Figure 7: The soft keyboard



Description of the keys in the soft keyboard:

---

	Switch to lowercase/uppercase
	Space
	Exit the soft keyboard
	Alphanumeric characters
	Backspace
	Punctuation
	Confirm selection

---

## Exiting the main menu

Press the **Menu** button on the front panel to exit the current menu window and return to live view, or click **Exit** in a main menu, or right-click using the mouse.

# Chapter 5

## Live view







### Description of live view

Live view mode is the normal operating mode of the unit where you watch live images from the cameras. The recorder automatically enters into live view mode once powered up. On the monitor you can see whether a recording is in progress and, if set up to do so, the current date and time, as well as the camera name.

### Status information

Information on the system and camera status is displayed as icons on the main and auxiliary monitors. The camera status icons are shown for each camera. Each icon represents information on a specific item. These icons include:

**Table 6: Description of the on-screen status icons**

Icon	Description
	Indicates an alarm.
	Indicates that a camera channel is being recorded.
	Indicates a motion detection event.
 Video Loss	Indicates a video loss event.
	Indicates alarm and system event notifications. Clicking the event hint icon opens the Alarm Center window that lists all the alarm and event notifications. See “Event notifications” on page 95 for more information.
	Indicates manual recording.
	Indicates that live view is locked from the front panel. Mouse actions are still allowed.

The recorder can display more than one icon at the same time.

The system status is displayed on the front panel by the status LEDs.

## Video output

The recorder automatically checks the monitor outputs used on startup.

If an HDMI monitor is used, it will be the main output. If HDMI and VGA monitors are both connected to the recorder, both will be main monitors; they will both show the same view.

The TVN 22P has two HDMI and two VGA ports. If the HDMI 4K resolution setting is used, the second HDMI port is disabled.

## Live view mouse menu

Many features of live view can be quickly accessed by placing the cursor on a live image and clicking the right-button of the mouse. The mouse menu appears (see Figure 8 below).

Figure 8: The mouse menu for the monitor A

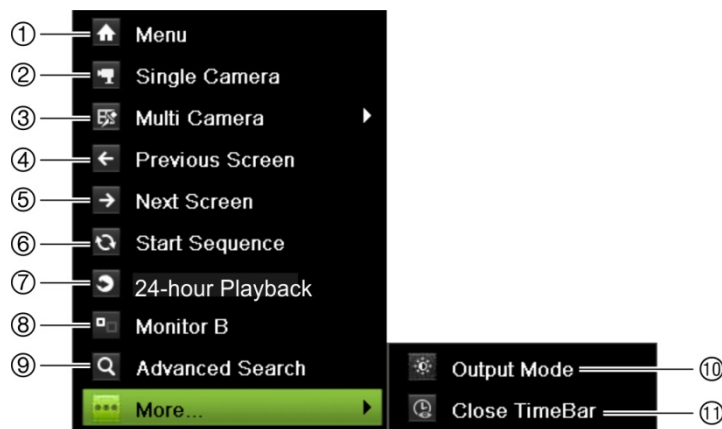

The list of commands available depends on which monitor is active; main or auxiliary (monitor B). See Table 7 below. The default settings of these commands are provided in the appendix under “Default menu settings” on page 153.

Table 7: Mouse menu for monitor A (main monitor)

Name	Description
1. Menu	Enter the Main menu. <b>Note:</b> Not available for monitor B.
2. Single Camera	Switch to a full-screen view for the selected camera from the drop-down list. See “Single and multiview display mode” on page 23 for more information.

Name	Description
3. Multi Camera	Switch between the different multiview options from the drop-down list. See “Single and multiview display mode” below for more information.
4. Previous Screen	Displays the previous camera.
5. Next Screen	Displays the next camera.
6. Start Sequence	Turn on sequence mode. The window automatically sequences between cameras. To set up the sequence dwell time, go to Menu > Display Settings > Display > Sequence Dwell Time and select a value.  <b>Note:</b> Not available for monitor B.
7. 24-hour Playback	Playback the recorded video of the selected day from the selected camera. The current day is selected by default.
8. Monitor B/Monitor A	Switch between monitors A (main) and B (event).
9. Advanced Search	Enter the advanced video search menu. See “Search video menu” on page 41 for more information.  <b>Note:</b> Not available for monitor B.
10. Output Mode	Select Standard, Bright, Soft, or Vivid mode to display.
11. Close TimeBar	Open/close the time bar.

## Single and multiview display mode

The recorder has single and multiview formats. The number of multiview display modes available depends on the recorder model.

Single view display format	Press the numeric button on the front panel to switch to the corresponding camera display. For example, press button 10 to view camera 10.  -Or-  Right-click the mouse and select <b>Single Camera</b> from the menu. Select the required camera from the list.
Multiple view display format	Press the <b>Display</b> button on the front panel to cycle through different display formats.  -Or-  Right-click the mouse and select <b>Multi Camera</b> from the menu. Select the desired multiview display layout.

## Sequencing cameras

The sequencing feature allows a camera to be displayed briefly on screen, before advancing to the next camera in the sequence list. Sequencing can only be done in single-view display mode.

The default sequence displays each camera in numerical order. However, each camera on the main and event monitors can have a pre-programmed dwell time and sequence order. See “Layout” on page 54 for more information.

**Note:** Dwell time must not be set to zero for sequencing to function.

### Sequencing cameras using the front panel:

Select the camera where you want to start sequencing. Press the  button on the front panel to start sequencing. Press it again to stop sequencing.

### Sequencing cameras using the mouse:

Select the camera where you want to start sequencing. Right-click the mouse and select **Start Sequence** to start the sequencing. Right-click again and select **Stop Sequence** to stop sequencing.



## Live view toolbar









The live view toolbar lets you quickly access regularly used commands. Position the cursor over a video tile and left-click the mouse. The toolbar appears (see Figure 9 below).

Figure 9: Live view toolbar



Table 8: Description of the live view toolbar icons

Icon	Description
	<b>Pause:</b> Freeze the live image of the selected camera. Although the image pauses, time and date information does not. The system clock continues to run.
	<b>Start Manual Recording:</b> Start/stop manual recording. The icon is red when manual recording is enabled. See “Recording schedule” on page 84 for information on setting up this function.
	<b>Instant Playback:</b> Playback the recorded video from the last five minutes. If no recording is found, then there was no recording made in the last five minutes. Click the icon and select the desired camera. Click OK. See “Modify the instant playback duration” on page 87 for more information.

Icon	Description
	<b>Audio On:</b> Enable/Disable audio output. The stream type must be set to Video/Audio. See “Camera recording settings” on page 60 for further information.
	<b>Snapshot:</b> Capture a snapshot of a video image. The image is saved on the unit. See “Search snapshots” on page 32 for further information.
	<b>PTZ Control:</b> Enter PTZ control mode. See “PTZ presets and tours” on page 26 for more information.
	<b>Digital Zoom:</b> Enter digital zoom. See “Digital zoom” on page 25 for further information.
	<p><b>Image Settings:</b> Enter the image settings menu to modify the image lighting levels. There are two options:</p> <p><b>Preset Mode:</b> These are preconfigured image lighting levels. Select one of the four options depending on current lighting conditions:</p> <ul style="list-style-type: none"> <li>- <i>Standard:</i> Use in standard lighting situations.</li> <li>- <i>Indoor:</i> Use indoors.</li> <li>- <i>Dim Light:</i> Use when the light level is low.</li> <li>- <i>Outdoor:</i> Use when outdoors. The contrast and saturation values are high.</li> </ul> <p><b>Customize:</b> Modify brightness, contrast, saturation, and hue values. Click Restore to restore image settings to previous values.</p> <p>Click <b>Restore</b> to restore image settings to previous values. Click <b>Default</b> to return to default values.</p> <p>These settings can also be modified from the Camera Setup &gt; Image menu (see page “Image settings” on page 63).</p>
	<b>Auxiliary Focus:</b> Automatically focus the camera lens for the sharpest picture.
	<b>Lens Initialization:</b> Initialize the lens of a camera with a motorized lens, such as PTZ or IP cameras. This function helps to maintain lens focus accuracy over prolonged periods of time.
	<b>Stream Information:</b> Display the real-time frame rate, bit rate, resolution and video compression.
	<b>Close Toolbar:</b> Close the toolbar.

## Digital zoom



You can easily zoom in or out of a camera image in live view mode and playback using the digital zoom command. The zoom command magnifies the camera image four times. See Figure 10 below.

**Figure 10: Digital zoom window****To quickly zoom in/out on a camera image:**

1. Left-click the mouse on the desired camera. The live view toolbar appears.
2. Click the digital-zoom icon. The digital view window appears.
3. Left-click the mouse and drag the red square to the area of interest, or press the arrow buttons on the front panel to position the red square. The selected area is magnified.
4. To exit digital zoom, right-click the mouse.

## PTZ preset and tours

When in live view you can quickly call up the list of existing presets, preset tours, and shadow tours by using the front panel, remote control, mouse, and keypad.

Front panel	Press  (Enter). PTZ control panel appears.
Mouse	Left-click the mouse on the desired camera image. The live view toolbar appears. Click the PTZ control icon  to enter PTZ mode. The PTZ control panel appears.
Remote control	Press the OK button. The PTZ control panel appears.
Keypad	Press the Enter  button on the keypad.





If the display was in multiview format, it changes to full-screen format for the selected camera. See Figure 11 on page 27 for a description of the PTZ control panel.



Figure 11: PTZ control panel



Table 9: Description of the PTZ control panel

Name	Description
1. Directional pad/auto-scan buttons	Controls the movements and directions of the PTZ. The center button is used to start auto-pan by the PTZ dome camera.
2. Zoom, focus, and iris	Adjusts zoom, focus, and iris.
3. PTZ movement	Adjusts the speed of PTZ movement.
4. Toolbar	 Turns on/off camera light (not used).  Turns on/off camera wiper (not used).  Zoom area.  Centers the PTZ dome camera image. This command is not supported on all PTZ dome cameras.  Jumps to the home position.
5. Select PTZ command	Displays the desired function from the scroll bar: Camera, Preset, Preset Tour or Shadow Tour.
6. Exit	Exits the PTZ control panel.

### To call up a preset:

- In live view, left-click the mouse and select the PTZ control icon in the quick access toolbar. The PTZ control panel appears. Select the desired camera from the toolbar.

– Or –

On the front panel, select the desired camera and press  (Enter) to call up the PTZ control panel.

- Scroll the control panel to **Preset** and double-click the desired preset from the list. The camera immediately jumps to the preset position.

### To call up a preset tour:

1. In live view, left-click the mouse and select the PTZ control icon in the live view toolbar. The PTZ control panel appears. Select the desired camera from the toolbar.

– Or –

On the front panel, select the desired camera and press  call up the PTZ control panel.

2. Scroll the control panel to **Tour** and double-click the desired preset tour from the list. The camera immediately carries out the preset tour movement.

### To call up a shadow tour:

1. In live view, left-click the mouse and select the PTZ Control icon in the live view toolbar. The PTZ control panel appears. Select the desired camera from the toolbar.

– Or –

On the front panel, select the desired camera and press  call up the PTZ control panel.

2. Scroll the control panel to **Shadow Tour** and double-click the shadow tour from the list. The camera immediately carries out the shadow tour movement.

# Chapter 6

## Searching files

This chapter describes how to search and playback recorded videos as well as search them by time, events, bookmarks, and snapshots.

### Advanced search video menu

You can easily search and play back recorded videos by time and date, events, bookmarks, and snapshots.

Figure 12: The Advanced Search menu

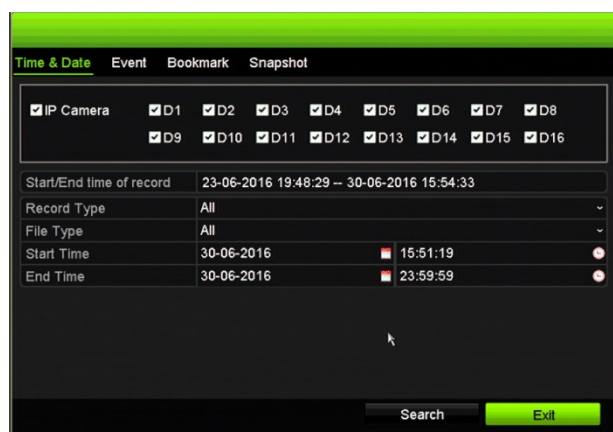

The Search window has four submenus that allow you to carry out different searches by theme:

Search type	Description
Time and Date	Search all video by time and date of recording.
Event	Search only event recorded files. Files can be searched by alarm inputs, text insertion, or intelligent alarms.
Bookmark	Search recorded files with bookmarks.
Snapshot	Search snapshots.

## Search results

A search will usually produce a list of recording files, which may extend to several pages. The files are listed by date and time. The most recent file is listed first. You can then select a file to play it back. See Figure 13 below for an example of a search.

A recording file can be up to 1GB in size. Every day at midnight a new recording file is started, and each event is also stored as a separate recording file.

Only one file can be played back at a time.

Figure 13: Example of a search result list





1. Click to lock recording to prevent it from being overwritten.
2. Click to playback the selected video.

## Search and play back recordings by time and video type

You can search recorded video by time and video type, such as continuous recordings, alarms and all recordings. Video can be played back simultaneously across several cameras.

### To search archived video files:

1. In live view, right-click the mouse on the desired video pane and select **Search Video**.  
– Or –  
Click the  Search button on the front panel.  
The Search menu appears.
2. Select the desired cameras, record type, file type as well as start and end times of the recording.
3. Click **Search**. The list of search results appears.
4. Click  to play back the search results:

**To immediately access archived footage:**

1. In the Search menu, click the “Time & Date” tab.
2. Select the desired cameras, record type, file type as well as start and end times of the recording. Up to four cameras can be selected.
3. Click **Go**. The simultaneous playback of up to four cameras for the indicated time will start.

## Search and play back recordings by event

You can search recorded video by event type: motion, VCA alarms, and alarm input.

**To play back search results:**

1. In live view, right-click the mouse on the desired video pane and select **Search Video**.
  - Or –
  - Click the  Search icon on the front panel.
  - The Search menu appears.
2. In the Search menu, click the “Event” tab.
3. Select the desired event type as well as start and end times of the recording.
4. Select the desired alarm inputs or channels.
  - If you selected “Intelligent Alarm” as the event type, select the required IP cameras.
5. Click **Search**. The list of search results appears.
6. Select the desired video from the list.
7. In the search results window, you can:
  - Click **Play** to playback the footage
  - Click **Archive** to archive results
  - Click **Details** to display more information about an event.

**Note:** You can modify the pre- and post-play periods of a recording.

## Search bookmarked recordings

For information on creating bookmarks, see “Create bookmarks” on page 45.

### To search for a bookmark:

1. In live view, right-click the mouse on the desired video pane and select **Search Video**.

– Or –

Click the  Search icon on the front panel.

The Search menu appears.

2. In the Search menu, click the “Bookmark” tab.
3. Select the desired cameras as well as start and end times of the recording to be searched. Also select the type of bookmark to be searched.

If searching for customized bookmarks, enter a keyword from the bookmark name.

Click **Search**. The list of bookmarks appears.

4. Select the desired bookmark from the list.
5. Select a bookmark and do one of the following:  
Click the **Edit** button to edit a bookmark’s name.

- Or -

Click the **Delete** button to delete a bookmark.

- Or -

Click the **Play** button to play back a bookmark.

## Search snapshots

You can search video snapshots. See “Live view mouse menu” on page 22 on how to create snapshots.

### To search for snapshots:

1. In live view, right-click the mouse on the desired video pane and select **Search Video**.

– Or –

Click the  Search icon on the front panel.

The Search menu appears.

2. In the **Search** menu, click the “Snapshot” tab.
3. Select the desired cameras as well as start and end times of the recording to be searched.

4. Click **Search**. The list of snapshots appears.

5. Select a snapshot to see it in the thumbnail window. Click its **Play**  button to see it in full-screen mode.

6. When in full-screen mode, move the cursor to the right edge of the window to see the complete list of snapshots found in the search. Click their Play buttons to see them in full-screen mode.
7. To see a slideshow of all the snapshots found, click the ► or ◀ buttons on the snapshot toolbar to sequence forwards or backwards through the shots.

## Log search

You can open video footage from the results of a log search. Refer to “Search the system log” on page 129 for more information.

# Chapter 7

## Playback functionality

The recorder lets you quickly locate and play back recorded video. There are multiple ways to play back video:

- Instant playback of the most recently recorded video
- 24-hour playback of one day's recorded video
- Search video by specific time, events, bookmarks, or snapshots (see Chapter 6 "Searching files" on page 29 for further information)
- Launch playback of video associated to searched events

The recorder continues to record the live view from a camera while simultaneously playing back video on that camera display. You must have the access privilege to play back recordings (see "Customize a user's access privileges" on page 122 for more information).



Figure 14: Playback window (24-hour playback shown)



1. **Playback mode:** Select one of seven playback modes to view: Normal, Event, Bookmark, Smart, Sub-periods, External File, or Snapshot. See “24-hour playback” on page 38 for more information.
2. Playback viewer.
3. Full screen.
4. Exit 24-hour playback recording. Click **Exit**  or right-click the mouse to return to live view.
5. **Quick camera select:**  
*Max. Camera for Playback:* From the camera list, automatically selects the first 16 cameras with recordings.  
*Min. Camera for Playback:* From the camera list, automatically select the first camera with recordings.  
**Note:** Cameras can also be selected manually. The maximum number of cameras that can be selected is 16, whether selected automatically or manually.
6. **Camera panel.** Select the cameras for playback. Move the mouse over the area to display the list of cameras available.
7. **Calendar panel.**  
**White:** No recordings.  
**Green/Yellow/Red/Pale green/Magenta:** Recordings available on the recorder.
8. **Playback control toolbar.** See Figure 15 on page 36 for more information.
9. **Time bar:** Time of actual playback. This is only displayed in 24-hour playback.
10. **24-hour recording progress bar:** This bar displays how much of the 24-hour period has been recorded.
11. **Recording type:** Description of the color coding of recording types that appear in the playback progress bar. Green indicates constant recording. Yellow indicates motion recording. Red indicates alarm recording. Pale green indicates manual recording. Magenta indicates VCA recording.

### The playback control toolbar

It is easy to manually control playback using the playback control toolbar. See Figure 15 on page 36.

**Note:** The playback control toolbar does not appear for instant playback.

**Figure 15: Playback control toolbar (Search playback example shown)**

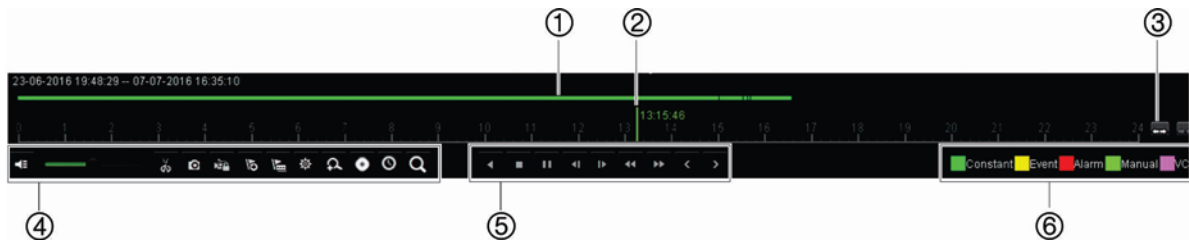

**Description**

1. **Playback bar:** This bar displays the playback recording. It indicates in color the type of recording. Constant recording is shown in the example above.













2. **Timeline:** Allows you to jump forwards or backwards in time. The timeline moves left (oldest video) to right (newest video). Click a location on it for where you want playback to start.

In 24-hour playback, the cursor shows the actual time.







In search playback, the cursor is a ball. The actual playback time of the ball position and how much playback has already played are also displayed.



3. Zoom in and out of the recording.

4. **Audio and video control toolbar:**

-  /  Audio on/off. When audio is On, use the scale to adjust the volume.
-  /  Start/stop a video clip during playback. Sections of a recording can be saved to an external storage device.
-  Quick snapshot. Click to take a snapshot of the recording.
-  Lock a file during playback.
-  Add default bookmark.
-  Add customized bookmark.
-  File management.  
Click to see the list of video clips, snapshots, locked files, bookmarks and their times. The video clips, playback captures and locked files can be archived. Bookmarks can be renamed and deleted.
-  Digital zoom.  
Click to enter the digital zoom function. Click again to exit.
-  Archive files.
-  Modify the forward and reverse skip times.
-  Call up the Search window to search for recorded video files by time & date, events, bookmarks, and snapshots.

5. **Playback control toolbar:**

-  Reverse play the recording. Click again to pause.
-  Stop playback. Time displayed is 00:00:00.
-  Play or pause playback.
-  Fast forward playback by the configured skip time (default is 30 seconds).
-  Reverse playback by the configured skip time (default is 30 seconds).
-  Decrease playback speed: Options available are: 1/2 speed, 1/4 speed, 1/8 speed, single frame.

Description	
	Increase playback speed. Options available are: 2X speed, 4X speed, 8X speed, 32X speed.
	Play previous file/day/event recording.
	Play next file/day/event recording in the search result.



6. **Recording type:** Description of the color coding of recording types that appear in the playback progress bar. Green indicates constant recording. Yellow indicates motion recording. Red indicates alarm recording. Pale green indicates manual recording. Magenta indicates VCA recording.

## Instant playback

Use the live view toolbar to instantly play back a predefined period (default time is five minutes). This can be useful to review an event that has just happened. Only one camera at a time can be selected.



You can modify the playback period in the Instant Playback Duration menu. See page 87 for further information.

### To instantly play back recorded video:

1. In live view mode, left-click the mouse on the desired camera image. The live view toolbar appears. Click the “Instant Playback” icon .
2. Click the Channel icon  and select the desired camera from the drop-down list. Click **OK**.

Playback starts immediately. The Instant Playback scroll bar appears under the selected camera.



3. Click **Pause**  on the toolbar to pause playback.  
Click **Play**  to restart playback.  
Click **Stop**  to stop playback and return to live view.

## 24-hour playback

Use this option to access one day of video recordings for the selected camera. Playback starts at midnight and runs for the 24-hour period. 24-hour playback is shown in full-screen view. See Figure 15 on page 36 for a description of the playback control toolbar. For the current day, playback will also start at midnight and runs until the most recent recordings.

### • Using the mouse:

1. In live view mode right-click the mouse on the desired camera image. In the mouse toolbar, click **24-hour Playback**.

The playback screen appears. By default, the camera is in full-screen mode.

2. To select more than one camera for synchronous playback or to select playback from a different day, move the mouse to the right edge of the screen. The camera list and calendar appear. Check the desired cameras and/or another day. Up to eight cameras can be selected.

Playback starts immediately you have selected the camera and times.

**Note:** A message appears if there are no recordings found during this period.

3. Use the playback control toolbar to manually control playback.
4. Click **Exit**  or right-click the mouse to return to live view.

### • Using the front panel:

1. Select the camera for playback and press the **Play** button. Playback from the selected camera starts immediately.



**Note:** Synchronous playback is only available using the mouse. If live view was showing multiview, only the camera in the top-left channel on screen will be played back.

2. To select a different camera for playback, press the numerical button of the desired camera.
3. Press **Live** to return to live view.

## 24-hour playback modes

You can select one of seven different 24-hour playback modes (see item 1 in Figure 14 on page 35). They are:

Playback mode	Description
Normal	<p>Play back recordings from the selected cameras of the selected day.</p> <p>Select the desired cameras and day to play back. Playback starts immediately.</p> <p>You can select all the playback toolbar options.</p>
Event	Play back recorded selected VCA, alarm inputs or motion events. See

	“Event playback” on page 39 for more information.
Bookmark	<p>Select the desired cameras and time period to search for bookmarks. Enter the desired keyword to search for a specific file name, if required. Click <b>Search</b>. The list of bookmarks appears. Change the pre and post-play times, if required.</p> <p>Click <b>Play</b> for the desired bookmark to play back.</p> <p>Click the <b>Exit</b> button to exit the playback of the selected bookmark and do another search, or click the <b>Search</b> icon  to open the Search window and select the Bookmark tab.</p> <p><b>Note:</b> You can only search for a bookmark by file name in the 24-hour playback mode.</p>
Smart	<p>This feature lets you selectively playback the parts of a recording with VCA and motion events and skip over video that does not have such events. See “Smart playback” on page 40” on page 39 for more information.</p>
Sub-periods	<p>This feature lets you see simultaneously the 24-hour playback recording for a selected camera split over several consecutive time periods. See “Split-screen playback” on page 42.</p> <p>Select the desired camera and number of split screens. Playback starts immediately.</p>
External file	<p>Import a file to play back.</p> <p>Insert the storage device, such as a USB flash drive, in the recorder and select a video file to play back.</p>
Snapshot	<p>Select the desired cameras and the time period. Click <b>Search</b>. The list of snapshots appears. Click <b>Play</b> to see the desired snapshot.</p> <p>To search again, click the <b>Search</b> icon  to open the Search window and select the Snapshot tab.</p>

## Event playback

This feature lets you selectively playback VCA, alarm input and motion events.

### To do an event playback:

1. In playback mode, select **Event** from the drop-down list on the upper left-corner of the window.
2. Select the type of event to search for from the right-hand side of the window: Alarm Input, Motion, or VCA Alarm.

If you select **VCA Alarm**, select the type of VCA alarm under **Minor Type**. Also select the desired cameras to search.

If you select **Alarm Input**, select the desired alarm inputs from the list displayed.

If you select **Motion**, select the desired cameras to search.

**Note:** Motion detection must be enabled in order to use this function. See “Motion detection” on page 64 for information.

3. Select the start and end dates and times for the event search.
4. Click  Search to searching for the desired events.

The results are listed on the right side of the window. Each individual recorded event is listed. They are collectively not shown on the playback toolbar.

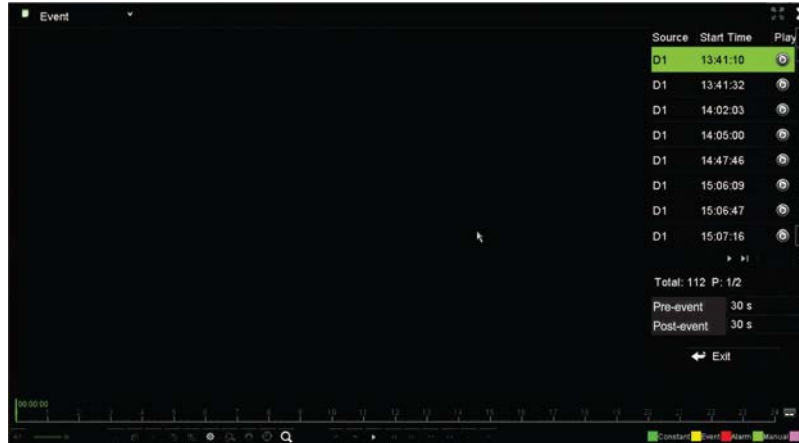

5. Select the desired pre and post-event times (between 5 and 600 seconds). Default time is 30 seconds.  
**Note:** These pre and post event times are independent to the times set for camera recordings under Camera Setup > Camera Recordings Settings.
6. Click the desired camera recording to play back. Its time bar also appears on the playback toolbar.
7. Click **Exit** to stop the play back and return to the previous window. You can do another search selection.
8. Click  to exit playback and return to live view.

## Smart playback

This feature lets you selectively playback the parts of a recording with VCA and motion events and skip over video that does not have such events. The Smart Playback mode analyses the video for VCA and motion events and marks them. See Figure 16 below.

Figure 16: Example of a smart playback recording

Smart event options





Smart bar showing all smart events found









For more information on VCA events, go to “VCA setup” on page 67.

### To do a smart playback:

1. In playback mode, select **Smart** from the drop-down list on the upper left-corner of the window.
2. Select a camera and date from the calendar on the right-hand side of the window.
3. Click  Play to start playing the recording.
4. Select the rules and areas to do a smart search for VCA or motion events in the recording.

Icon	Description
	<p><b>Cross line detection:</b> This is used to detect people, vehicles and objects crossing a pre-defined line or an area on-screen. If someone or an object crosses the line, the time of the event is shown on the Smart bar.</p> <p>Click the icon and then click on the image to indicate the start and end points of the line. If you want to change the line position, re-click the icon and draw the line again.</p>
	<p><b>Intrusion detection:</b> This is used to detect when intrusion occurs. If someone enters the selected area, the time of the event is shown on the Smart bar.</p> <p>Click the icon and then click on the image the four points on the image the set the quadrilateral area for intrusion detection. Only one area can be set. If you want to change the detection area position, re-click the icon and draw the area again.</p>
	<p><b>Motion detection:</b> This is used to detect motion in a selected area.</p> <p>Click the icon and then drag the mouse to draw the motion detection area.</p> <p><b>Note:</b> It is not necessary to have motion detection enabled to use this feature.</p>



Icon	Description
	<b>Motion detection:</b> This is used to detect motion over the whole image. Click the icon. By default, the whole image is selected as the detection area.
	Clear all areas selected.
	Start and stop video clipping.
	File management for video clips.
	Stop playback.
	Play or pause playback.
	Smart settings.
	Search matched video files.

- Click  Smart Settings to select the settings for the smart search:

**Skip non-related video:** Video that does not have selected events will not be played.

**Play non-related video:** Set the speed to play the video with no selected events.

**Play related video:** Set the speed to play the video with selected events.

- Click  Search to search and play back video with the matched events, which are shown in the Smart bar.

## Split-screen playback

This feature lets you see simultaneously the 24-hour playback recording for a selected camera split over several consecutive time periods.

You can display the recording between four and twelve split screens. The recording is split into equals time periods depending on the number of split screens selected. See Figure 17 below.



Figure 17: Example of split-screen playback

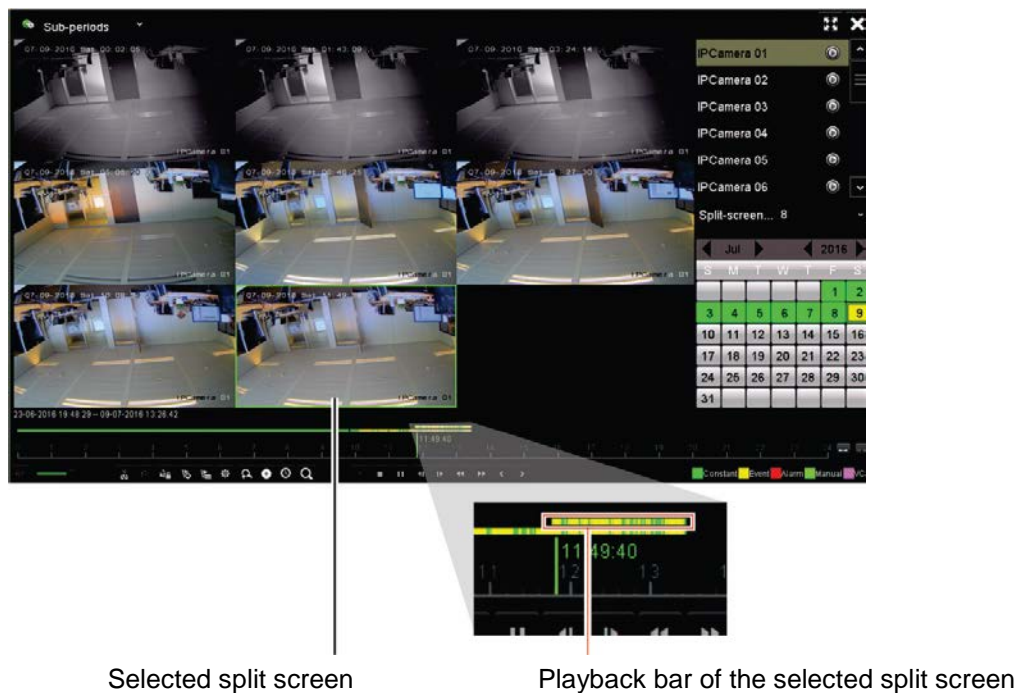

Selected split screen

Playback bar of the selected split screen

### To do a split-screen playback:

1. In playback mode, select **Sub-periods** from the drop-down list on the upper left-corner of the window.
2. Select a camera and date from the calendar on the right-hand side of the window.
3. In the **Split-screen** drop-down list box, select the desired number of split screens. Up to 12 screens can be selected. Default is 2x2 screens.

The split screens immediately appear.

## Playback speed and skip time

### To set the playback skip time:



1. In playback mode, click  **Skip Time** button on the on the playback control toolbar. The skip time menu appears.
2. Select a skip time between 10 and 300 seconds. The default skip time is 30 seconds.

### To change the playback speed:

*From the front panel:*

Press the left and right buttons to speed up and slow down recorded video.

*From the playback window using the mouse:*



Click  and  to speed up and slow down recorded video.

## To skip forwards or backwards during playback:

*From the front panel:*

Press the up and down buttons to jump recorded video forwards and backwards by a set skip time.

*From the playback window using the mouse:*

Click  and  to jump recorded video forwards and backwards by a set skip time.

— Or —

Click a location on the timeline for where you want playback to start.

## Play back frame-by-frame

You can play back a selected video at different speeds. This allows you to carefully examine an event frame-by-frame as it happens.

The current frame rate is shown on the right of the playback control toolbar.

### To play back frame-by-frame:

#### • Using a mouse:

1. In playback mode click the **Speed Down**  button in the playback control toolbar until the speed changes to single frame.
2. Click the **Pause** button to advance the video frame by frame.

#### • Using the front panel:

1. In playback mode move the left direction button to left to scroll down through the speed changes until single frame.
2. Press **Enter** to advance the video frame by frame.

## Digital zoom in playback

### To digitally zoom-in during playback:



1. In playback mode, click the  Digital Zoom button in the playback control toolbar.  
The playback control toolbar disappears. The digital zoom window appears.
2. Left-click the mouse and drag the red square in the digital zoom window to the area of interest, or move the joystick on the front panel to position the red square. The selected area is magnified.

3. Right-click the mouse to quit the digital zoom mode and return to full-screen playback mode. The playback control toolbar reappears.

## Create bookmarks

You can bookmark the important scenes in a recorded file for later reference.

Bookmarks flag the start of a scene. Up to 64 bookmarks can be saved in a video file. There are two types of bookmarks:

- **Default bookmark** : All default bookmarks have the same generic name, "BOOKMARK".
- **Customized bookmark** : The bookmark is given a name for easy identification. The same name can be used for several bookmarks.

You can search both types.

### To create a bookmark:

1. Open a 24-hour playback window or the playback window from a search result.
2. In the playback recording, click the timeline bar where you want the bookmark to be. The green time line jumps to this position. Click the button for the type of bookmark you want, and enter the bookmark name if required.

In the playback recording from a search, click the scroll bar where you want the bookmark to be. The scroll bar ball jumps to this position. Click the button for the type of bookmark you want, and enter the bookmark name if required. The bookmark is saved.

3. Click the  button to search for bookmarks saved.

### To rename or delete bookmarks:



1. In playback mode, click the  **File Management** button. The *File Management* window appears.
2. Select the Bookmark tab.
3. Select the bookmark you want to edit and click **Edit**. Enter the new name and click **OK**.
4. Select the bookmark you want to delete. Confirm the deletion.

## Lock playback files

You can lock recorded files during playback to playback the important scenes for later reference. The files cannot be overwritten. In multichannel playback, using this *Lock File* function will lock all the recorded files for the playback channels.

**Note:** Locking too many files will reduce the storage capacity of the recorder.

**To lock and archive files during playback:**

1. In playback mode, click the  **Lock File** button on the on the playback control toolbar to lock the current recording file.
2. To see the list of locked files saved, click the  **File Management** button and in the *File Management* window, select the *Locked File* tab. The list of locked files is shown.

**To unlock a locked file**

1. In playback mode, click the  **File Management** button and in the *File Management* window, select the *Locked File* tab. The list of locked files is shown.
2. Click the lock symbol of the desired file to unlock. The file is no longer protected.

## Manage playback files

You can manage the video clips, snapshots, locked recordings and bookmarks that you create during 24-hour playback.

**To archive video clips, snapshots and locked files:**

1. In playback mode, click the  **File Management** button. The *File Management* window appears.
2. Select the tab for the files you want to manage: Video Clips, Snapshot, or Locked File.

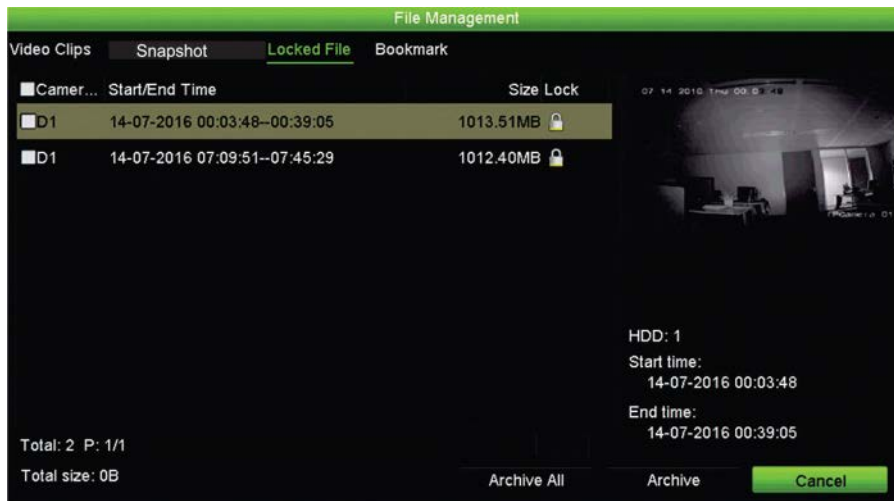

3. Insert your backup device into the recorder.
4. Select the files you want to archive and click **Archive** or **Archive All**. The files are saved.

# Chapter 8

## Archiving files

Archive recorded files on an external device such as USB flash drive, USB HDDs or a USB DVD burner. You must be in live view to archive video. Access to archive commands may require a password.

Before starting to archive files, ensure that you have the backup device connected to the recorder. It can be detected automatically by the recorder.

The recorder supports USB DVD and USB HD on the front and back USB ports.

**Note:** It is recommended to connect DVD writers to both USB ports of the front panel to make sure it receives enough power.

The recommended DVD writers are:

- Pioneer XU01
- Samsung SE208DB/TSBS

## Archiving files

There are two ways to archive files:

**Quick Archive button:** Quick archive lets you archive recorded files quickly by using the Archive button on the front panel. The recorder then downloads all the recorded files on the unit to fill the available memory space on the media. This option is not available via the mouse.

**Search results window:** In many search results windows there is an “Archive” button. Click it to bring you to the archive window of the selected video in the search result.

### Quick Archive

**To archive recorded video using Quick Archive:**

1. Insert the backup device into the recorder.

If using a USB memory drive, insert the device into the USB port on the front panel. If more than one media type is found, the USB device takes precedence over the others.

2. Press **Archive** on the front panel or remote control to open the quick archive window.
3. Click **Start** or press **Archive** on the front panel again. The unit starts to download all the files listed.

**Note:** If there is a capacity limitation on the backup device, only the most recent files will be backed up.

A message will appear to confirm when the download is complete.

## Archive menu

You can insert a mini-USB hub to the USB port to attach a mouse for navigation or a USB drive for archiving. However, the unit may not support all types of USB hubs.

The Archive options available may depend on the type of backup device selected.

You can also archive files while in 24-hour playback by clicking the File Management icon in the playback control toolbar. See “24-hour playback modes” on page 38 for more information.

Figure 18: Example of an archive window

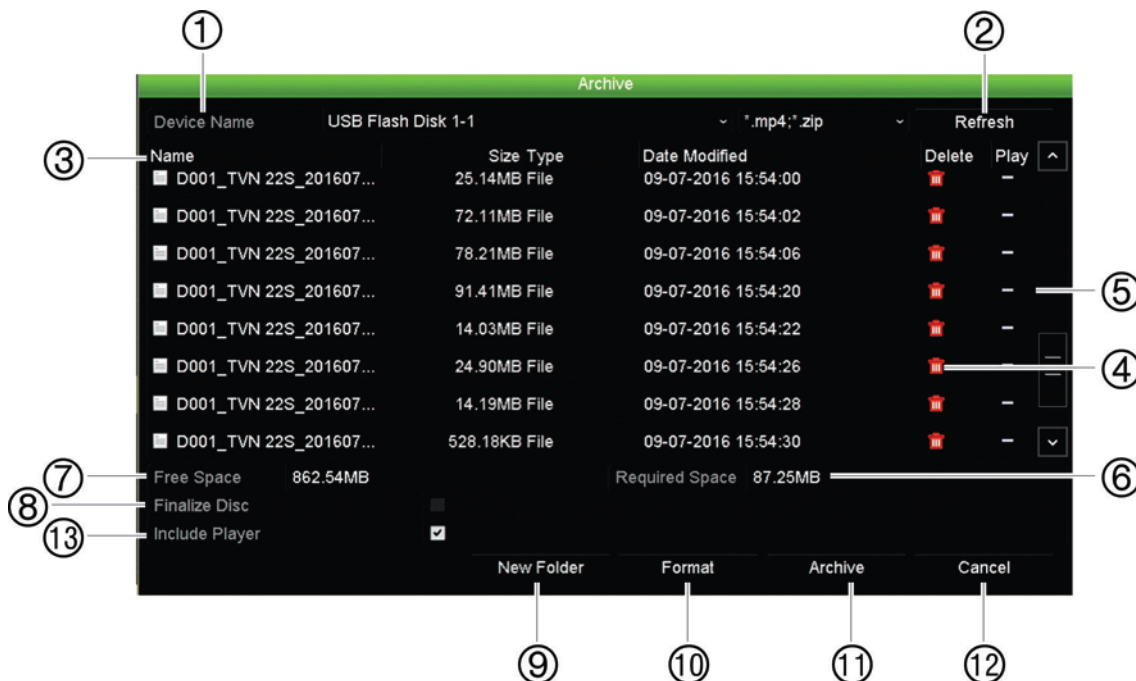

Function	Description
1. Device Name	Select one of the storage media for archiving. If the backup device is not recognized: <ul style="list-style-type: none"> <li>• Click the Refresh button</li> </ul>

Function	Description
	<ul style="list-style-type: none"> <li>• Reconnect device</li> <li>• Check for compatibility from vendor</li> </ul>
2. Refresh	Refresh the search results if any parameters have been modified.
3. Name	Files found on the backup device are listed.
4. Delete	Click to delete a selected file from the backup device.
5. Play	Click to play selected file.
6. Free Space	Free space available on the backup device is displayed.
7. Required Space	Total space on the backup device is displayed.
8. Finalize Disc	Select to prevent other files being recorded onto the disc.
9. New Folder	Create a new folder on the backup device. Files from the recorder can be archived to a specific folder.
10. Format	Format the USB/eSATA drive.
11. Archive	Start downloading selected files onto the backup device.
12. Cancel	Cancel search and return to previous menu.
13. Include Player	Select to automatically include the Player tool when archiving files.

## Export files

### To export recorded files to a backup device:

1. Connect the backup device to the recorder.

If using a USB memory drive, insert the device into the USB port on the front panel. If using a digital video disk (DVD) or eSATA drive, insert the disc into the DVD drive. If both media are found in the recorder, the USB device takes precedence over the DVD.

2. In live view mode press the **Search** button on the front panel or remote control.

- Or -

Right-click the mouse and select **Advanced Search**.

The *Advanced Search* window appears.

3. Select the cameras and search parameters required.
4. Click **Search**. The list of results appears.
5. Select the files to export.

**Note:** You can click the **Play** button to verify that the selected files are the files to export.

6. Click **Archive**. The Archive window appears.
7. Select the storage medium to export to from the drop-down list. If you are using a USB 3.0 compatible device, it is recommended to use the USB on the back panel.



8. Click **Archive** to begin the backup process.

## Create and archive video clips

You can save important scenes in a recorded file for later reference by creating video clips of selected portions of the file during playback. When an intruder, for example, crosses in front of several cameras you can save the video clip of the intruder's path across these cameras in a single file.

**Note:** This feature is only available using the mouse.

### To export video clips during playback:

1. Connect the backup device to the recorder.
2. Search for the required files to play back. See "Search and play back recordings by time and video type" on page 30
3. Select the file or files to play back and click **Play**. Playback starts immediately.
4. Click the playback timeline where you want the video clip to start and click the **Start Clipping**  button.
5. Click the playback timeline where you want the video clip to stop and click the **End Clipping**  button.
6. Repeat for additional clips.
7. Exit playback mode. A message appears asking if you want to save the video clips.
8. Click **Yes** to archive the clips. The File Management window appears.  
Click **No** to exit and return to the search results window. The clips are not saved.
9. In the File Management window click **Archive**. In the Archive window that appears, select from the drop-down list the backup device to be used. If you are using a USB 3.0 compatible device, it is recommended to use the USB on the back panel.  
**Note:** The Player tool is automatically saved with the file unless the option is deselected.
10. Click **Archive**. File downloading starts.  
**Note:** You can create a new folder for the video clips. Press the **New Folder** button and enter the folder name.

## Playing back archived files on a PC

Use the standard file player software, TruVision Player, to play back the archived video on your PC. It is downloaded automatically from the recorder when archiving files onto a backup device.



Note that in some cases a limited file player is included in the recorder. If so, when opening the file player on your PC, the software will prompt a message stating that a full version of the player is available for download from our website: [www.interlogix.com](http://www.interlogix.com).

## Using TruVision Player

### Playing back video using TruVision Player

You can include multiple files in the TruVision Player playlist. Double-click the desired video file from the list and click the **Start** button. When the first file finishes, the next file will automatically start.

### Merging video files in TruVision Player

1. Add the exported video files to TruVision Player,
2. Click the menu icon  and select **Tool > Merge**.
3. The Merge window appears. Click **Add File** to add the files you want to merge onto a selected video file. Under **Output Setting**, select the video file to which you want to add the files.

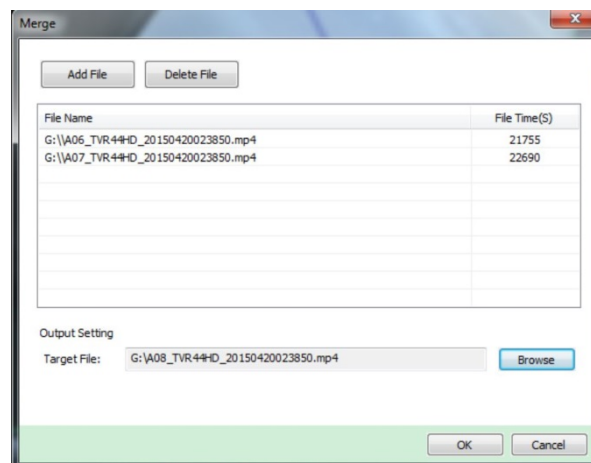

# Chapter 9

## Display settings

Use the Display Settings menu to modify how the camera images appear on screen.

### Display settings

Use the Display Settings menu to adjust the settings related to the local monitor output of the recorder, such as selecting the main and event monitors, multiview layout, display the monitor time bar, sequence dwell time options, and enable or disable the local audio output. See Figure 19 on page 53.

The recorder can use the BNC, HDMI and VGA outputs independently. The TVN 22P recorder has two HDMI and two VGA outputs that mirror each other and one BNC output.

The outputs of the recorder are managed A+B+Spot, meaning that the HDMI or VGA monitor can be used to display the menu. The output that does not control the monitor can display live or recorded video. The BNC output of the recorder can be used as an event monitor. Note that the BNC output is also used as source for the TVN 22 V-stream encoding.

Figure 19: Display Settings window



Table 10: Description of the Display setup window

Option	Description
1. BNC Output Standard	Define the desired output mode. The BNC output can be used as event monitor and also produces the image that is used for the V-stream. Select one of the options from the drop-down list: PAL or NTSC, and click <b>Apply</b> .
2. Picture Setting	Define the desired output mode. Select one of the options from the drop-down list: Standard, Bright, Soft, or Vivid, and click <b>Apply</b> .
3. BNC Output Brightness	Define the desired brightness by using the slider.
4. VGA Resolution	Define the resolution of the selected monitor. Select one of the options from the drop-down list and click <b>Apply</b> . The selected resolution must be the same as that of the monitor.
5. HDMI Resolution	Define the resolution of the selected monitor. The resolution can be up to 4K. Select one of the options from the drop-down list and click <b>Apply</b> . The selected resolution must be the same as that of the monitor.
6. Display Status Icons	Define whether the status icons are displayed. Default is Enable.
7. Time Bar Transparent	Select the transparency of the monitor output time bar on screen relative to the background to make the time bar easier to read. Check the box to enable/disable. Default is Disable.
8. Enable Time bar	Select whether the monitor output time bar appears on screen. Check the box to enable/disable. Default is Enable.
9. Time Bar Size	Select the size of the time bar: Large, Medium, or Small. Default is Large.

Option	Description
10. Video Output Interface	Select the desired video output interface to apply: VGA, HDMI or V-stream/BNC. Default is HDMI.  <b>Note:</b> When using the TVN 22P, default is VGA/HDMI.
11. Default View	The factory default multiview format displays all channels (4x4 layout for the 8/16-channel NVR 22S).
12. Sequence Dwell Time	Set the length of time for which a camera image is displayed on the selected monitor before moving to the next camera during sequencing. Default is off ("No Switch").
13. Enable Audio Output	Select whether to hear audio from cameras in both live and playback mode. However, in order to be able to hear audio in playback, you must enable the audio output setting. Default is Disable.  Check the box to enable/disable audio output.
14. Volume	Define the desired volume by using the slider.
15. Event Monitor	Select which monitor will be the event monitor showing full screen monitoring in case of events: HDMI/VGA or BNC.
16. Event Full Screen Monitoring Dwell Time	Set the length of time during which an image is displayed on the event monitor in full screen in case of an event. Default is 10 seconds.
Alarm Full Screen Monitoring Dwell Time	Set the length of time during which an image is displayed on the event monitor in full screen in case of an alarm. Default is 10 seconds.

## Layout

The Layout window allows you to define the layout of each of the different views as they are shown when selecting the different live views or the sequencing order.

The cameras are sequenced in numeric order by default. You can change the order of the cameras for all monitors.

The camera order in the different views is consistent. This means that if Channel 2 is the first camera shown in the single camera view then it will also be the top left camera of the 4-channel view.

You can switch the channel of a camera with that of another camera in the system. This lets you, for example, have the images of camera 1 appear on channel 10, and the images of camera 10 appear on channel 1. This feature is useful when you want to watch the sequence of images from specific cameras so that they are next to each other on-screen.

See Figure 20 on page 55. Each video tile displays both the order of the camera on screen and the camera number.

Go to Display Settings > Display to modify the dwell time for sequencing.

Figure 20: Camera layout window



# Chapter 10

## Camera setup

Use the Camera Setup menu to configure IP cameras. You can also configure the camera status, OSD, snapshots, recording settings, image settings, PoE setup, motion detection, privacy masking, camera tampering, restrict access, PTZ configurations and VCA settings.

**Note:** Not all settings are available for IP cameras. For advanced IP camera settings, please consult the IP camera web browser interface.

### Supported IP cameras

The NVR supports TruVision and UltraView IP cameras as well as TVE encoders. It supports a wide range of third party IP cameras through compliancy with the Onvif and PSIA standards for open camera communication.

Please see the camera compatibility list for more detailed information.

### IP camera status

The IP camera status menu allows you to add, edit and remove cameras to the recorder, as well as update the cameras' firmware or change its admin passwords.

Figure 21: IP camera window



Table 11: Description of the IP camera window

Option	Description
1. IP camera list	This shows the list of IP cameras added to the recorder. The camera information shown is: Camera No., Status, PoE port, Edit, Advanced Set, Live View, Camera Name, IP Camera Address, Manage Port, Protocol, Device Model, Serial Number, and Firmware.
2. Sync Password	Sets all connected TruVision IP cameras to the same admin password as the recorder.
3. Manual Add	Add a camera manually to the recorder by entering its IP address and other required information.
4. Device Search/Add	Search the network for available TruVision or other natively supported IP cameras. Add an IP camera to the recorder system.
5. Upgrade	Upgrade IP camera software. Insert USB flash drive in the recorder and select the upgrade file. The camera will automatically reboot once the software is upgraded.
6. Delete	Delete the selected IP camera from the list.
7. Refresh	Update the information displayed on a camera in the recorder device list.

### To automatically add an IP camera:

1. From the menu toolbar, click **Camera Setup > IP Camera Status**.
2. Click **Device Search/Add** to search for any supported IP cameras located in the recorder LAN.

**Note:** If cameras still have default settings, they might have the same IP addresses. This creates an IP conflict. Before adding the IP camera to the recorder, use the Edit button to assign a different IP address to each camera.

3. Check the boxes of the cameras that you want to add to the recorder.

4. Click **Add** to add the selected cameras to the list of devices in the recorder. Click **Back** when complete to return to the main window.

The cameras are added to the end of the list of devices.

5. To test if a camera connection is operational, select the desired camera from the list of devices connected to the recorder and click the **Live** button. A pop-up window should appear showing the camera's live view.

#### To manually add an IP camera:

1. From the menu toolbar, click **Camera Setup > IP Camera Status**.
2. Click **Manual Add**. In the pop-up window, enter the camera details such as the IP camera address/domain, protocol, management port, user name, and password. Click **OK**.

The camera is added to the end of the list of devices.

**Note:** Only one camera can be manually added at a time.

## Using RTSP custom protocols

Many IP cameras can stream video using RTSP. The recorder allows you to define RTSP custom protocols per camera type and to add cameras to the recorder via RTSP.

#### To configure RTSP custom protocols:

1. From the menu toolbar, click **Camera Setup > IP Camera Status**.
2. Click **Manual Add**. In the pop-up window, enter the camera details such as the IP camera address/domain, protocol, management port, user name, and password. Click **OK**.
3. Create a Custom Protocol by clicking **Protocol**. Select your parameters.
4. Click **Apply** to save the settings. Then click **OK** and **Add**.

**Note:** When adding cameras via RTSP, only video streaming is available. No other functionality will be supported by the recorder.

## PoE power budget (TVN 22S only)

The PoE power budget information is only available for the TVN 22S.

It is important when installing IP cameras to calculate the total power consumption required so that it is less than the power budget of the NVR switches. The NVR lets you easily track on-screen the current and remaining power consumption for all cameras directly connected to its switches. See Figure 22 on page 59.



Figure 22: PoE power budget information on IP cameras



1. Select the PoE type required for each camera.
2. Dynamic tracking of the current PoE power consumption (blue), unallocated PoE power (white), and remaining allocated PoE power budget (green) shown.

The IP cameras will specify which type of PoE they require. You can set up each camera individually for No PoE, PoE-at, PoE-af, or 12.5 W. A PoE port can support up to 30 W maximum.

The recorder has a maximum of 8 or 16 PoE ports, depending on the model. The total PoE power budget for the 8-channel recorder is 120 W, and that for the 16-channel recorder is 200 W.

The PoE-af port can support between 0 and 15.4 W and the PoE-at port can support between 0 and 30 W. See Table 12 below for a description of the maximum number of IP cameras that can be connected depending on the PoE type used.

Table 12: Maximum number of IP cameras that can be connected by PoE power consumption

Recorder	Total PoE power budget	Maximum number of IP cameras connected			
		12.5 W	15 W	PoE-af	PoE-at
TVN-2208S	120	-	8	7	4
TVN-2216S	200	16	-	12	6

**Note:** The PoE power specifications are the PoE power available at the recorder. However, depending on the cable length and cable quality you can experience a loss of PoE power. Ensure that this is taken into account when configuring the system.

#### To display the PoE power consumption information:

1. From the menu toolbar, click **Camera Management > Camera > PoE Setup**.
2. Select the PoE type required for each camera: No PoE, PoE-af, PoE-at, or 12.5 W.
3. Click **Apply** to save the settings and then click **Back** to return to live view.

## Automatically allocating PoE power (TVN 22S only)

The recorder can be set up to automatically allocate PoE power depending on each camera's needs. Note that if the full PoE budget (120/200 W) is used on the first seven ports, for example, PoE port 8 will no longer be powered.

### To set up auto PoE:

1. From the menu toolbar, click **Camera Management > Camera > PoE Setup**.
2. Check **Auto PoE**.
3. Click **Apply** to save the settings and then click **Exit** to return to live view.

## Camera recording settings

The camera recording settings allow you to define the configuration per camera per stream recording mode.

### To configure recording settings:

1. From the menu toolbar, click **Camera Recording Settings**.



2. Select the camera you want to configure.
3. Configure the following recording settings (options available depend on the camera model):
  - **Stream Record Mode:** Select one of the stream types to configure the recording parameters of that record mode: Mainstream (TL-Hi) (default), Mainstream (TL-Lo), Mainstream (Event), Mainstream (Alarm), or Substream.
  - **Stream Type:** Select the type of stream to record, either Video or Video & Audio. Default is Video.
  - **Resolution:** Select the resolution of the recording. Options include: 8MP, 6MP, 5MP, 3MP, 1080p, UXGA, 720p, VGA, 4CIF, DCIF, 2CIF, CIF, QCIF.

- **Bitrate Type:** Select Variable (default) or Constant. If “Variable” is selected, the bandwidth can vary depending on video quality and the bandwidth required. If “Constant” is selected the video streaming is always at the maximum bit rate selected.
- **Video Quality:** Select the quality at which to record. If “Constant” is selected as the bit rate type, this option is unavailable.

If a low video quality is selected, the image quality is poorer and the bandwidth required is reduced thereby allowing recording over a longer period of time.

- **Frame Rate:** Select the recording frame rate.
- **Max. Bitrate mode:** Select the general (Default) or customized option.
- **Max. Bitrate (kbps):** If the customized maximum bit rate mode was selected, enter the value here. It must be between 32 and 4096 kbps. It is calculated from the frame rate and time required. Default is 1792.
- **Pre Event:** This is the time the camera starts recording before the event. Select the time in seconds from the list to start pre-recording before the event. Default is 5 seconds.

The maximum pre-recording times available depend on the constant bit rate. See “Maximum pre-recording times” in the appendix.

- **Post Event:** This is the time the camera continues to record after the event. Select the time in seconds from the list to stop post-recording after the event. Default is 5 seconds.
- **Auto Delete (day):** Select the number of days after which recorded video from the specified camera is permanently deleted from the HDD. A “day” is defined as the 24-hour period from when the auto delete mode (ADM) was set.  
The maximum number of days that can be set is 365. However, the actual number of days permitted depends on the HDD capacity. If the value is set to ‘0’, the option is disabled. Default is Disable.
- **Record Audio:** Enable to record sound with the images. Default is Enable.

4. Click **Apply** to save the settings and then click **Exit** to return to live view.

## Snapshots

You can define the image quality and resolution of snapshots for each camera. Snapshots can be taken at any time during live view or playback, or can be created when an alarm occurs and sent by email or sent to an FTP server.

### To configure snapshots:

1. From the menu toolbar, click **Camera Setup > Snapshots**.
2. Select the desired camera.
3. Select the snapshot resolution from the drop-down list.

Select QCIF, CIF, 4CIF, or Maximum. Maximum is the maximum available resolution from the camera. For IP cameras, this is the resolution being recorded.

4. Select the snapshot quality from the drop-down list (low, medium or high).
5. Click **Apply** to save the settings.
6. To copy the settings to other cameras, click **Copy** and select the desired cameras. Click **OK**.
7. Click **Exit** to return to live view.

## Camera OSD

The recorder lets you configure which information is displayed on-screen for each individual camera.

The on-screen display (OSD) settings appear in live view mode and include the camera name, time and date. They are part of the image and are therefore also recorded.

### To configure the OSD settings:

1. From the menu toolbar, click **Camera Setup > Camera OSD**.



2. Under **Camera**, select the desired camera.
3. Under **Camera Name**, enter a name for the camera, if required. The name can have up to 32 alphanumeric characters.
4. Check the **Display Name**, **Display Date**, and **Display Day** boxes to display the camera name, date, and week.
5. Select a date format and a time format.
6. Select how you want the camera information displayed.

Select one of the options from the drop-down list. Default is non-transparent/non-flashing.

- Transparent & Flashing
  - Transparent & Not Flashing
  - Non-transparent & Flashing
  - Non-transparent & Not Flashing
7. There are two colored text boxes in the camera view window; one for the camera name (red box) and the other for the date/time (yellow box). Using the mouse, click and drag a text box to the display position.
  8. To copy the settings to other cameras, click **Copy** and select the desired cameras. Click **OK**.
  9. Click **Apply** to save the settings and then click **Exit** to return to live view.

## Image settings

The Image tab allows you to adjust image settings for each individual camera channel.

You may need to adjust the camera image depending on the location background in order to get the best image quality.

The system has image settings for frequently encountered lighting conditions; Standard, Indoor, Dim Light, and Outdoor. You can also manually adjust the brightness, contrast, saturation, hue, and saturation values.

You can modify the digital noise reduction (DNR) value to improve image quality. This function removes image noise from a video signal, which can be more pronounced in low light conditions.

**Note:** These options can also be modified from the image settings button on the live view toolbar (see “Live view toolbar” on page 24).

### To adjust display settings:

1. From the menu toolbar, click **Camera Setup > Image**.
2. Under **Camera**, select the desired camera.
3. Under **Image Setting**, select the camera for which to adjust the video image settings (Standard, Indoor, Dim Light, or Outdoor).
4. Adjust the brightness, contrast, and saturation values by dragging each scroll bar. Click the **Default** button to return image setting values to the default position.
5. Select how you want the camera to rotate the image. There are two rotate functions:

Enable Rotate	You can rotate the image 270°  In a vertical-shaped scene, such as a hallway or corridor, the image is shown with a vertical (tall) rather than horizontal (wide) format. The video image is at a 9:16 aspect ratio.
Mirror Mode	You can flip the camera image three ways:  Left-Right: Flip the image horizontally.

---

Up-Down: Flip the image vertically.

Center: Flip both horizontally and vertically.

---

**Note:** This is only available for cameras that support the function.

- Click **Apply** to save the settings and then click **Exit** to return to live view.

## Motion detection

The motion detection menu allows you to enable or disable motion detection for each camera as well as create motion grids, set the sensitivity of the motion detection, and link motion detection to a specific action.

### To set up motion detection:

- From the menu toolbar, click **Camera Setup > Motion Detection**.  
Areas covered by the red grid are sensitive to motion detection.
- Select the camera to detect motion. Each camera must be set up individually.
- Check **Enable Motion Detection**. If this is not enabled, motion will not be recorded.
- Check **Enable Dynamic Analysis**. This allows you to see on-screen motion being detected while setting up the feature. Areas where motion is detected are shown as solid red squares in the motion grid.
- Create the areas on-screen to be sensitive to motion.

Click and drag the mouse cursor across the window to select areas sensitive to motion detection, which are shown as a red motion grid.

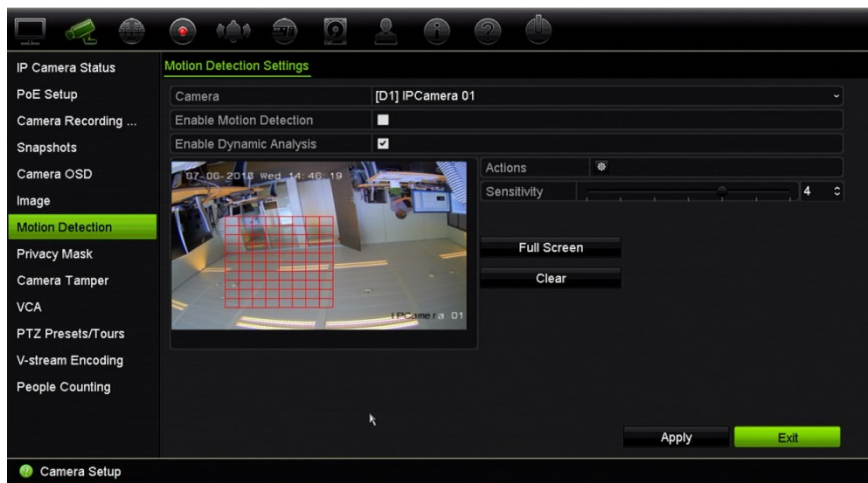

Click **Full Screen** to activate the whole screen or **Clear** to clear the screen.

- Set the sensitivity level.

Drag the Sensitivity scroll bar to the desired sensitivity level. Maximum sensitivity is

- Default is 4.

7. Select the cameras that will start the motion recording schedule once motion is detected.

Click **Actions**. The Actions window appears. Click the **Trigger Channel** tab and select the cameras that will record when a motion alarm is triggered.

Click **Apply** to save the settings.

8. Select the arming schedules for motion detection.

In the Actions window, click the **Arming Schedule** tab and select the day of the week and the time periods during the day when motion detection can trigger the given actions. You can schedule up to eight time periods in a day. Default is 24 hours. Note that when motion detection is enabled, motion events will always trigger event recording, regardless of the arming schedule.

Click **Apply** to save the settings. Click **Copy** to copy the settings to other days of the week.

**Note:** Time periods defined cannot overlap.

9. Link the corresponding action to motion detection.

In the Actions window, click the **Actions** tab to define the method by which you want the recorder to notify you of the alarm: Full-screen Monitoring, Enable Alarm Audio, Notify Alarm Host, Send Email, Upload Snapshots to FTP, Play Audio File, and Trigger Alarm Output. See page 95 for the list of alarm notification types. More than one option can be selected.

Click **Apply** to save settings.

10. Click **OK** to return to the motion detection settings window.

11. Click **Exit** to return to live view.

## Privacy mask

You can define an area on screen to remain hidden from view and recording. For example, you can choose to block the view of a camera when overlooking residential premises. This hidden area is referred to as privacy masking. Privacy masking cannot be viewed in live view or recorded mode, and appears as a black area on the video image.

For IP cameras, the number of privacy masks is determined by the number supported by the camera.

### To setup a privacy mask:

1. From the menu toolbar, click **Camera Setup > Privacy Mask**.
2. Select the camera for which to set up privacy masking.
3. Check the **Enable Privacy Mask** box to enable the feature.
4. Set up the mask area. Up to four areas can be set.

Using the mouse, click and drag a privacy-mask box in the camera view window over the desired area. You can set up to four areas for privacy masking. Masked areas are dimmed and outlined in four different colors. Click **Apply** to save settings.

To delete a mask, click **Clear Zone** for that color mask.

5. To copy the settings to other cameras, click **Copy** and select the desired cameras. Click **OK**.
6. Click **Apply** to save the settings and then click **Exit** to return to live view.

## Camera tamper

You can setup the recorder to alert you when the camera view has changed such as when someone has deliberately blocked the camera view by spraying paint on the lens or by moving the camera. Tampering detection only applies when the whole image is covered and all light is blocked. You cannot select a specific area of the camera screen to detect tampering.

**Note:** It is strongly recommended not to configure for video tampering when using PTZ dome cameras.

### To set up video tampering detection:

1. From the menu toolbar, click **Camera Setup > Camera Tamper**.
2. Select a camera to configure for video loss detection.
3. Check the **Enable Camera Tamper** box to enable the feature.
4. Select the tamper detection sensitivity level by clicking the sensitivity scroll bar. Higher sensitivity is to the right of the bar.
5. Select the recording schedules for the tamper.

Click **Actions** and then select the **Arming Schedule** tab to select the day of the week and the time periods during the day when motion can be recorded. You can schedule up to eight time periods in a day. Default is 24 hours.

Click **Apply** to save the settings. Click **Copy** to copy the settings to other days of the week and holiday period.

**Note:** The time periods defined cannot overlap.

6. Select the response method to an external alarm.

Click **Actions** and then select the **Actions** tab to select the method by which you want the recorder to notify you of the alarm: Full-screen Monitoring, Enable Alarm Audio, Notify Alarm Host, Send Email, Play Audio File, and Trigger Alarm Output. See page 95 for the list of alarm notification types. More than one option can be selected.

Click **Apply** to save settings and then **OK** to return to the main window.

7. Click **Exit** to return to live view.



## VCA setup

The configuration of each individual VCA (Video Content Analysis) event is done in the camera browser. Within the recorder, you are able to link actions to a VCA alarm from IP cameras that support this feature.

There are several types of VCA events to select. A series of linkage methods can be triggered if a VCA event is detected. See Table 13 below.

**Note:** VCA events do not trigger recordings; they are marked in the recorder and allow you to easily find the assisted video. It is recommended to use continuous recording or to enable motion detection in combination with VCA events.

**Table 13: VCA types**

VCA event types	Description
Face Detection	When this function is enabled, the camera can detect a moving object that is moving towards it, triggering a configurable response. The camera can only detect a face looking directly into the camera, not side views. This feature is best suited when the camera is in front of a door or is located in a narrow corridor.
Cross Line Detected	This function can be used to detect people, vehicles and objects crossing a pre-defined line or an area on-screen. The line crossing direction can be set as unidirectional or bidirectional. Unidirectional is crossing the line from left to right or from right to left. Bidirectional is crossing the line from both directions.
Perimeter Intrusion Detected	You can set up an area in the surveillance scene to detect when intrusion occurs. If someone enters the area, a set of alarm actions can be triggered.
Enter Region Detected	This function detects people, vehicles or other objects that enter a designated region from outside the designated region.
Exit Region Detected	Region exiting detection function detects people, vehicle or other objects that exit from a designated region, and certain actions can be configured to occur when the alarm is triggered.
Object Left Behind Detected	Unattended baggage detection function detects the objects left in the designated region such as baggage, a purse, dangerous materials, etc.
Object Taken Detected	Object removal detection function detects objects removed from a designated region, such as exhibits on display.
Audio Input Exception	Audio exception detection detects sounds that are above a selected threshold.
Defocus Detected	The camera can detect image blur caused by defocusing of the lens, triggering a series of alarm actions.  The sensitivity level determines how much blur is tolerated by the camera before triggering an alarm. When enabled, the camera regularly checks the level of image focus (to allow for variations in light during the day) and then compares the current image to that of the reference image to see if there is a difference. A high sensitivity level means that there cannot be a large variance between the reference and current image.

VCA event types	Description
Sudden Scene Change	You can configure the camera to trigger an alarm when the camera detects a change in the scene caused by a physical repositioning of the camera.

### To setup VCA alarm actions:

1. From the menu toolbar, click **Camera Setup > VCA**.
2. Select the camera for which to set up the VCA alarm.
3. Check the **Enable VCA Alarm** box to enable the feature.
4. Select the desired VCA type.
5. Select the recording schedules for the selected VCA.
6. Click the Actions button to define which actions are required with each selected VCA event from each camera.

In the Actions window, click the **Trigger Channel** tab and then select the cameras to be triggered for recording when an alarm is detected. Click **Apply** to save the settings and then **OK** to return to the VCA window.

7. Select the recording schedules for the VCA event.

In the Actions window, click the **Arming Schedule** tab and select the day of the week and the time periods during the day when motion can be recorded. You can schedule up to eight time periods in a day. Default is 24 hours.

**Note:** The time periods defined cannot overlap.

Click **Apply** to save the settings. Click **Copy** to copy these settings to other days of the week. Click **OK** to return to the VCA window.

8. Select the response method to a VCA event.

In the Actions window, click the **Actions** tab to define the method by which you want the recorder to notify you of the alarm: Full-screen Monitoring, Enable Alarm Audio, Notify Alarm Host, Send Email, Play Audio File, and Trigger Alarm Output. See page 95 for the list of alarm notification types. More than one option can be selected.

Click **Apply** to save the settings and then **OK** to return to the VCA window.

9. Click **Apply** to save all the settings and then click **Exit** to return to live view.

## PTZ presets and tours

Presets are previously defined locations of a PTZ dome camera. It allows you to quickly move the PTZ dome camera to a desired position. They are configured and modified from the Camera Setup > PTZ Presets/Tours window (see Figure 23 below).











Tours are series of presets. Shadow tours allow you to record the manual movement of a PTZ and follow the same tour at a later date.

**Note:** The PTZ dome camera used must be able to support a preset command.

Figure 23: PTZ configuration window



Table 14: Description of the PTZ configuration window

Name	Description
1. Save preset	Saves preset.
2. Call preset	Calls up pre-existing preset.
3. Shadow tour toolbar	 Starts recording the shadow tour.  Saves the shadow tour.  Starts the selected shadow tour.  Deletes the selected shadow tour.
4. Preset tour toolbar	 Adds a step to a selected preset tour.  Starts the selected preset tour.  Stops the selected preset tour.  Deletes all the preset tour steps.  Scroll up the list.  Scroll down the list.

### To set up a preset:

1. From the menu toolbar, click **Camera Setup > PTZ Preset/Tours**.
2. Use the directional, zoom, focus, and iris buttons to position the camera in the desired preset location.
3. Check **Save Preset** and enter a preset number. The preset is enabled and stored in the camera.

If the desired preset number is larger than the 17 numbers listed, click [...]. The Preset window appears. Select a preset number from the drop-down list and click the **OK** button to save changes.

**Note:** Presets can be overwritten.

4. Click **Exit** to return to live view.

### To call up a preset:

1. From the menu toolbar, click **Camera Setup > PTZ Preset/Tours**.
2. Check **Call Preset** and enter the preset number to call up. The camera immediately moves to that preset position.
3. Click **Exit** to return to live view.

### To delete a preset:

1. From the menu toolbar, click **Camera Setup > PTZ Preset/Tours**.
2. From the preset list, select a preset number, and click  to delete the selected the preset.
3. Click **Exit** to return to live view.

### To call up a preset tour:

1. From the menu toolbar, click **Camera Setup > PTZ Preset/Tours**.
2. Check **Call Preset** and enter the preset number to call up. The camera immediately moves to that preset position.
3. Click **Exit** to return to live view.

### To set up a preset tour:

1. From the menu toolbar, click **Camera Setup > PTZ Preset/Tours**.
2. Select the preset tour number.
3. In the preset tour toolbar, click  to add a step to the preset tour. The Step window appears. Select the preset number, dwell time and speed of the step. Click **OK** to save the settings.

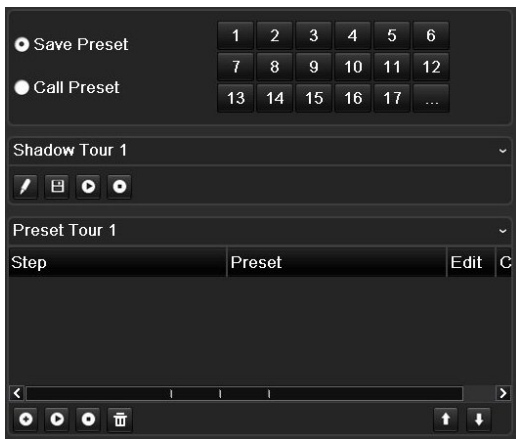

**Note:** A preset tour should have at least two presets.

4. Repeat step 3 to configure other steps in the preset tour.



5. In the preset tour toolbar, click  to call up the preset tour.
6. Click **Exit** to return to live view.

#### To call up a preset tour:

1. Click the **PTZ Settings** icon on the menu toolbar and select **More Settings**.
2. Select the desired preset tour from the list and click  to start the tour. Click  to stop the preset tour.
3. Click **Back** to return to live view.

#### To delete a preset tour:



1. From the menu toolbar, click **Camera Setup > PTZ Preset/Tours**.
2. From the preset tour list, select a tour number and click  to delete the selected the preset tour.

– Or –

In the preset tour toolbar, click  to delete all the preset tours.

3. Click **Exit** to return to live view.



#### To set up a shadow tour:

1. From the menu toolbar, click **Camera Setup > PTZ Preset/Tours**.
2. Select the shadow tour from the drop-down list.
3. To record a new shadow tour, click  and use the directional buttons on the PTZ control panel to move the camera along the desired path.
4. Click  to save the shadow tour.

**Note:** The shadow tour can be overwritten.

5. Click **Exit** to return to live view.

### To call up a shadow tour:

1. From the menu toolbar, click **Camera Setup > PTZ Preset/Tours**.
2. Select the shadow tour from the list and click  to start the tour. Click  to stop the shadow tour.
3. Click **Exit** to return to live view.

## V-stream encoding

If the available bandwidth is limited, you can remotely view several channels in real time with one stream over the web browser or VMS (Video Management System), such as TruVision navigator, using the V-stream encoding option ("V" stands for "virtual"). When enabled, you can see the output from the cameras on a remote client monitor in one stream.

**Note:** The V-stream uses the layout that is set up for the BNC monitor.

### To setup V-stream encoding:

1. From the menu toolbar, click **Camera Setup > V-Stream Encoding**.
2. Check the **Enable V-Stream Encoding** box to enable the feature.
3. Select the **Frame Rate** from the drop-down menu.
4. Select the **Max. Bitrate** from the drop-down menu.

**Note:** The layout of the V-stream can be set up via the OSD menu (Display Settings > Layout menu (BNC)) or via the webpage.

## People counting

This function helps to calculate the number of people or objects entering or exiting a configured area and is primarily used with entrances or exits.

Set up the people counting function from the camera itself. Please refer to the camera's configuration manual for further information.

**Note:** This function cannot distinguish between a moving person and a moving object.

### To set up counting statistics:

**Note:** An SD card must be installed and configured in the camera in order to save count data and generate reports.

1. From the menu toolbar, click **Camera Setup > People Counting**.
2. Select the camera from which you want to count objects.
3. Select the report type: Daily report, Weekly report, Monthly report, and Annual report.

Daily report calculates the data on the selected date. Weekly report calculates for the week of the selected date. Monthly report calculates for the month of the selected date. Annual report calculates for the year of the selected date.

4. Select the statistics time.
5. Click **Counting** to list the object counting result.
6. To export the data to an Excel file, click **Export**.

# Chapter 11

## Network settings

The Network settings menu allows you to manage all network related aspects of the recorder including general network settings, DDNS, NTP synchronization, email setup, and FTP server setup.

Additionally, the Net Detect and Network statistics menus provide you with a useful and efficient tool to analyze the behavior of the recorder on the network.

You must correctly configure your recorder's network settings before using it over the network in order to:

- Connect IP cameras to it
- Connect to the recorder over the LAN
- Connect to the recorder over the internet

### Network settings

**Note:** As every network configuration may differ, please contact your Network Administrator or ISP to see if your recorder requires specific IP addresses or port numbers.

#### To configure general network settings:

1. From the menu toolbar, click **Network Settings > Network Settings**.





## 2. Enter the required settings:

Option	Description
1. Working Mode	Select from Multi-address, Load Balance, and Net Fault Tolerance. This option is not available on the TVN 22S.  <b>Multi-address:</b> Each LAN port is separate with its own IP address. This allows one LAN port for the IP cameras and the other for client PCs such as TruNav.  <b>Load Balance:</b> The bandwidth is divided over the two LAN ports with one IP address.  <b>Net Fault Tolerance:</b> When one LAN port fails, the other one takes over. This is the default option.
2. NIC Type	Network interface card (NIC) is a device used to connect the recorder to a network. Select the NIC type used from the drop-down list.
3. Internal NIC IPv4 Address	This is only available for TVN 22S. Enter the internal NIC IPv4 address. This is the IP address of the recorder's internal network managing only the PoE port cameras. This is not the LAN IP address.  Default value is 192.168.254.1.
4. Bridge PoE Camera Network	This is only available for TVN 22S. Check this box to enable the Bridge PoE Camera Network.  Default value is Enable.
5. Enable DHCP	DHCP (Dynamic Host Configuration Protocol) is a protocol for assigning an IP address dynamically to a device each time it connects to a network.  Check this box if you have a DHCP server running and want your recorder to automatically obtain an IP address and other network settings from that server. The DHCP server is typically available in your router.  Default value is Disable.
6. IPv4 Address	Enter the IP address for the recorder. This is the LAN IP address of the recorder.  Default value is 192.168.1.82.

Option	Description
7. IPv4 Subnet Mask	Enter the subnet mask for your network so the recorder will be recognized within the network.  Default value is 255.255.255.0.
8. IPv4 Default Gateway	Enter the IP address of your network gateway so the recorder will be recognized within the network. This is typically the IP address of your router. Consult your router user manual or contact your ISP to get the required information on your gateway.  Default value is 192.168.1.1.
9. MAC Address	Displays the MAC address. The MAC address is a unique identifier of your recorder and it cannot be changed.
10. Preferred DNS Server	Enter the preferred domain name server to use with the recorder. It must match the DNS server information of your router. Check your router's browser interface or contact your ISP for the information.
11. Server Port	Use the server port for remote client software access. The port range is between 1024 and 65535.  Enter the server port value. The default value is 8000.
12. Multicast IP	Enter a D-class IP address between 224.0.0.0 to 239.255.255.255. Only specify this option if you are using the multicast function. Some routers prohibit the use of multicast function in case of a network storm.
13. IPv6 Address 1	Enter the IPv6 address for the recorder.  Default value is fe80::240:30ff:fe48:2975/64.
14. IPv6 Address 2	Enter the IPv6 address for the recorder.
15. IPv6 Default Gateway	Enter the IPv6 address of your network gateway so the recorder will be recognized within the network. This is typically the IP address of your router.
16. MTU (Bytes)	Enter a value between 500 and 9676. Default is 1500.
17. Alternate DNS Server	Enter the alternate domain name server to use with the recorder.
18. HTTP Port	By default the HTTP port value is 80.
19. RTSP Service	The RTSP (Real Time Streaming Protocol) is a network control protocol designed for use in entertainment and communications systems to control streaming media servers. The default value is 554.
20. Outgoing Bandwidth Limit (Kbps)	Outgoing Bandwidth. The default value is 81920.

3. Click **Apply** to save the settings and **Exit** to return to live view.

## PPPoE settings

Although not usually used, you can connect the recorder directly to a DSL modem. To do this, you need to select the PPPoE option in the network settings. Contact your ISP to get the user name and password.

### To configure PPPoE settings:

1. From the menu toolbar, click **Network Settings > PPPoE**.
2. Check the enable PPPoE box.
3. Enter your user name and password and confirm the password.
4. Click **Apply** and manually reboot the recorder to save the settings.

## DDNS settings

DDNS servers allow you to connect to your recorder using a dynamic address. This dynamic address needs to be registered with a DNS service. The DDNS setup menu allows you to enable or disable DDNS and to configure it using ezDDNS, No-IP or DynDNS.

**Note:** Some service providers block the default RTSP streaming port 554 used for video streaming, so if you are not receiving video images over the internet, you may need to change it to another value. See Appendix C “Port forwarding information” on page 149 for more information.

There are three ways to set up a DDNS account:

- **ezDDNS:** A free-of-charge service included with your recorder and fully managed within the recorder interface. It is exclusive to TruVision products.
- **DynDNS:** A third-party service where users need to apply for a DynDNS account on the Dyn.com website.
- **No-IP:** A third-party service where users need to apply for a no-IP account on the no-ip.com website

Figure 24: ezDDNS setup window

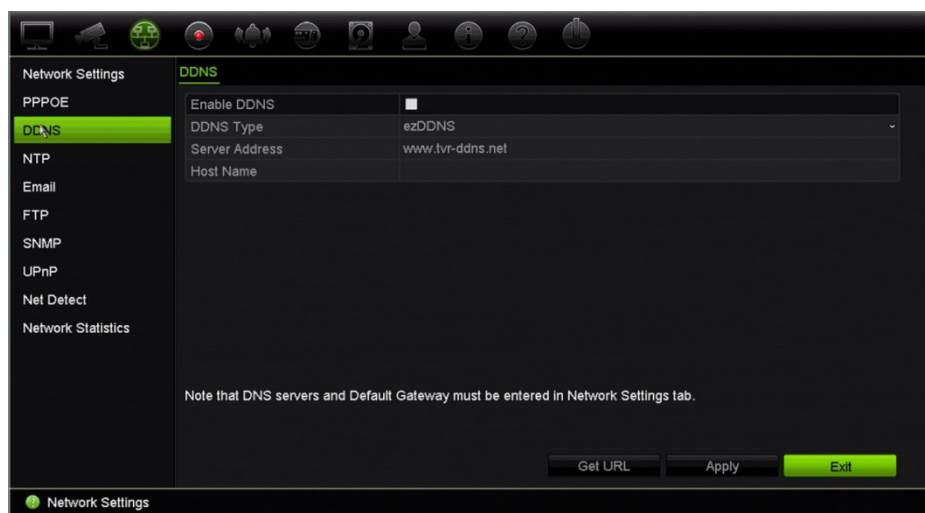

**Note:** You cannot have two recorders with the same host name.

### To set up DDNS:

1. From the menu toolbar, click **Network Settings > DDNS**.
2. Check the **Enable DDNS** box to enable this feature.
3. Select one of the DDNS types listed:

**ezDDNS:** Click the **Get URL** button. The URL address to access the unit is displayed. If no host name is specified, the DDNS will allocate one automatically.

The maximum length for the host name field is 64 characters. This limit does not include tvn-ddns.net. An example of a host name could be *max64chars.tvr-ddns.net*.

- Or -

**DynDNS:** Select **DynDNS** and enter the server address for DynDNS. In the recorder domain name field, enter the domain name obtained from the DynDNS web site. Then enter your user name and password registered in the DynDNS network.

For example:

Server address: members.dyndns.org

Domain: mycompanydvr.dyndns.org

User name: myname

Password: mypassword

- Or -

**NO-IP:** Enter server address (for example, dynupdate.no-ip.com). In the host name field, enter the host obtained from the NO-IP web site. Then enter the user name and password that are registered with the No-IP network.

4. Ask your ISP service provider for your DNS server address or look it up in the browser interface settings of your router.

Go to **Network Settings** and enter the preferred and alternate DNS server addresses as well as the default gateway address.

5. Click **Apply** to save the settings and click **Exit** to return to live view.

## NTP server settings

A Network Time Protocol (NTP) server can also be configured on your recorder to keep the date and time current and accurate.

**Note:** If the device is connected to a public network, you should use a NTP server that has a time synchronization function, such as the server at the National Time Center (IP Address: 210.72.145.44) or europe.ntp.pool.org. If the device is setup in a more customized network, NTP software can be used to establish a NTP server used for time synchronization.

**To set up an NTP server:**

1. From the menu toolbar, click **Network Settings > NTP**.
2. Check the NTP box to enable feature. It is disabled by default.
3. Enter the NTP settings:
  - **Interval (min):** Time in minutes to synchronize with the NTP server. The value can be between 1 and 10080 minutes. Default is 60 minutes.
  - **NTP Server:** IP address of the NTP server. Default is time.nist.gov.
  - **NTP Port:** Port of the NTP server. Default is 123.
4. Click **Apply** to save the settings and click **Exit** to return to live view.

## Email settings

The recorder can send email notifications of alarms or notifications through the network.

**Note:** Ensure that the DNS address has been set up correctly beforehand.

**To configure email settings:**

1. From the menu toolbar, click **Network Settings > Email**.
2. Enter the required settings.

Option	Description
Enable Server Authentication	Check the box if your mail server requires authentication and enter the login user name and password.
User Name	If the mail server requires authentication, enter the login user name.
Password	If the mail server requires authentication, enter the login password.
SMTP Server	Enter the SMTP server's IP address.
SMTP Port	Enter the SMTP port. The default TCP/IP port for SMTP is 25.
Enable SSL/TLS	Check the box to enable SSL/TLS if it is required by the SMTP server. This feature is optional.
Sender	Enter the name of the sender of the email.
Sender's Address	Enter the sender's email address.
Select Receiver	Select an email recipient. Up to three receivers can be selected.
Receiver	Enter the name of the receiver of the email.
Receiver's Address	Enter the email address of the receiver.
Include Snapshot	Check the Attach JPEG File box if you want to send an email with attached alarm images.
Interval	Select an interval range in the Interval box.  The interval range represents the time range in between the alarm images being sent. For example, if you set the interval range at two seconds, the second alarm image will be sent two seconds after the first alarm image

3. Click **Test** to the test email settings.

**Note:** We recommend that you test the email settings after entering values in the email window.

4. Click **Apply** to save the settings and click **Exit** to return to live view.

## Configure an FTP server to store snapshots

You can upload your snapshots to an FTP server for storage.

**Note:** It is not possible to stream video to an FTP site.

**To configure the FTP server settings:**

1. From the menu toolbar, click **Network Settings > FTP**.
2. Check the **Enable FTP** box.
3. Enter the FTP server information.
4. Select the directory to use (root, parent, or secondary). If Parent or Secondary were selected, select the desired options for them.
5. Click **Apply** to save the settings and click **Exit** to return to live view.

## SNMP settings

SNMP is a protocol for managing devices on networks. When you enable SNMP in the menu, network management systems can retrieve recorder status information from the recorder via SNMP.

When you set the trap address and trap port in the recorder menu to the network management system's IP address and port number, and set up the network management system as trap receiver, trap notifications (such as startup) are sent from the recorder to the network management system.

Before configuring this function, you must first install the SNMP software.

**To configure SNMP protocol settings:**

1. From the menu toolbar, click **Network Settings > SNMP**.
2. Check the **Enable SNMP** box.
3. Enter the required settings.
4. Click **Apply** to save the settings and click **Exit** to return to live view.

## UPnP settings

The recorder supports UPnP (Universal Plug and Play). This feature lets the recorder automatically configure its own port forwarding, if this feature is also enabled in the router.

You can select one of two methods to set up UPnP:

**Automatic mapped type:** The recorder automatically uses the free ports available that were set up in the Network Settings menu.

**Manual mapped type:** You enter the particular external port settings and IP addresses required to connect to the desired router.

### To enable UPnP:

1. Connect the recorder to the router.

**Note:** The router must support UPnP and this option must be enabled.

2. From the menu toolbar, click **Network Settings > UPnP**.

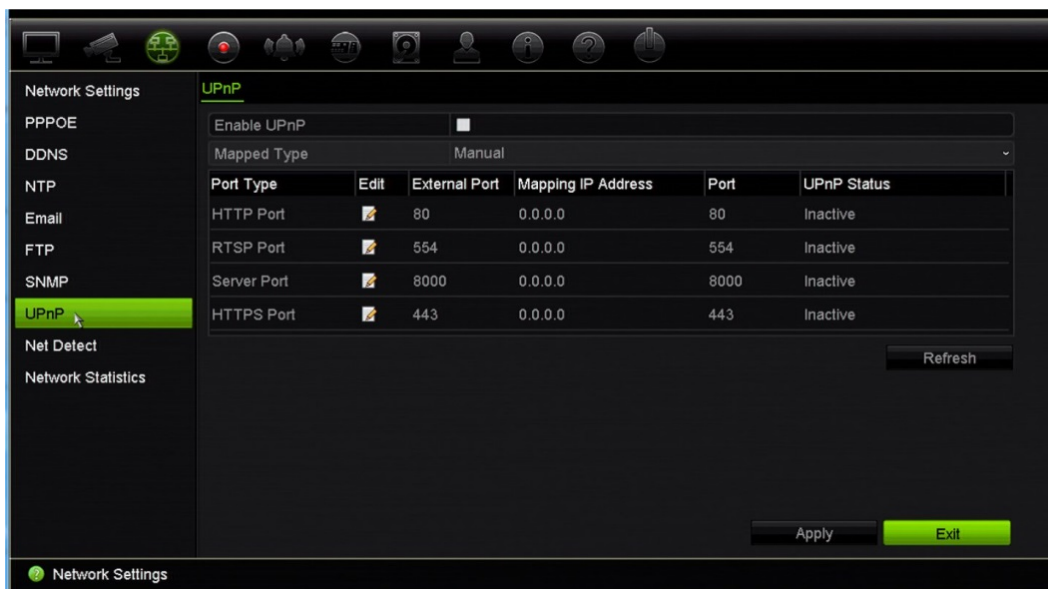

3. Check the **Enable UPnP** box.
4. From **Mapped Type**, select Auto or Manual.

If **Manual** is selected, enter the external ports and IP addresses required. Click the **Edit** icon to change the values.

5. Click **Apply** to save the settings and click **Exit** to return to live view.

## Network status

You can easily check network traffic in order to obtain information about the recorder such as its linking status, MAC address, MTU, sending/receiving rate, and NIC type.

The Network Detection window shows the network traffic between the recorder and your local network. However, the traffic between the plug and play cameras and the NVR 22S is not shown.

You can also check the network connection status by testing its delay and packet loss.

**To check network traffic:**

1. From the menu toolbar, click **Network Settings > Net Detect**. The Traffic window appears. The information displayed is refreshed once a second.

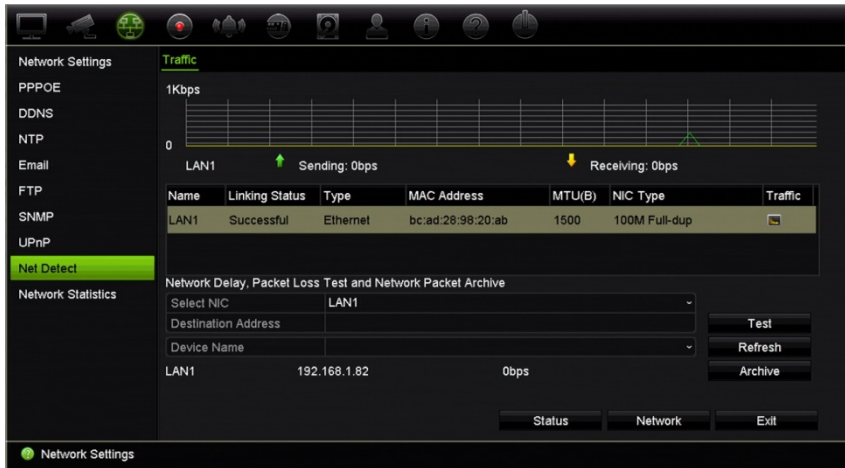

**To check network delay and packet loss:**

1. From the menu toolbar, click **Network Settings > Net Detect**.
2. Under **Select NIC**, select the destination address. Click **Test**.

The test result appears in a pop-up window.

3. If you need to check the current network parameters, click the **Network** button to get an overview. The current values for NIC type, DHCP, IPv4 address, IPv4 subnet mask, IPv4 default gateway are shown as well as the preferred DNS server and alternate DNS server, if used.

The **NIC Type** and **Enable DHCP** options can be changed. Click **Apply** to save any changes made and then click **OK** to return to the main window.

4. Click **Exit** to return to live view.

**To check network status:**

1. When all the network parameters have been set, click the **Status** button to confirm that all parameters are operating correctly.

## Archive network packet data

When the recorder is connected to a network, you can archive the captured data packet to a USB-flash drive, SATA/eSATA CD-RW and other local backup devices.



**To archive network packet data:**

1. From the menu toolbar, click **Network Settings > Net Detect**.
2. Click **Refresh** to get a list of the local backup devices available, which are listed under **Device Name**. Select one from the list.
3. Click **Archive** to export the data to the backup device. Up to 1M of data can be exported at a time.
4. Click **Exit** to return to live view.

## Network statistics

You can easily check the bandwidth that is being used by remote live view and playback.

**To check network statistics:**

1. From the menu toolbar, click **Network Settings > Net Statistics**.
2. The latest information is displayed on the bandwidth used by remote live view and playback as well by Net Receive Idle and Net Send Idle. Click **Refresh** to update the information.
3. Click **Exit** to return to live view.

## Port forwarding

When using an internet connection, ensure that the ports are open or forwarded as follows:

- **When using TruNav:** Port 8000 and 554
- **When using a web browser:** Port 80 and 554

See “Internet Explorer users” on page 132 for more information.

# Chapter 12

## Recording

Use the Recording menu to define the camera recording schedules, modify the instant playback duration, setup Auto Archive Settings, review the Auto Archive Status, set up a hot spare recorder, record on an SD card, and to select the cameras for manual recording.

### Recording schedule

Defining a recording schedule lets you specify when the recorder records video and which pre-defined settings are used. Each camera can be configured to have its own recording schedule.

The schedules are visually presented on a map for easy reference. See Figure 25 on page 85 for a description of the recording schedule window.

**Note:** If a camera is set up for continuous recording, it will still switch to event recording or alarm recording if events are triggered or to alarm recording when alarms are triggered. This can be turned off in the individual action settings for each individual alarm if needed.

Figure 25: Description of the recording schedule window



1. **IP camera.** Select a camera.
2. **Schedule time.** Represents the 24-hour cycle during which a schedule is selected.
3. **Schedule map.** There are eight days to select: Sunday (Sun), Monday (Mon), Tuesday (Tue), Wednesday (Wed), Thursday, (Thu), Friday (Fri), Saturday (Sat), and Holiday (if enabled)..
4. **Recording type.** There are five types of recording to select, which are color-coded:
  - TL-Hi (Dark green): High quality time lapse. Records high quality video.
  - TL-Lo (Bright green): Low quality time lapse. Records low quality video. This could be used, for example, for night recordings when few events or alarms are expected. Saving the video in low quality helps save resources on the HDD.
  - Event (Yellow): Records only events, such as motion detection.
  - Alarm (Red): Records only alarms.
  - None (Gray): No recording during this period.
5. **Edit button.** Click to modify schedules and to copy schedules to other days of the week.
6. **Timeline.** There is a 24-hour time line for each day. Up to eight recording periods can be scheduled during the 24-hour period.
7. **Copy button.** Click to copy schedules between cameras.

## Define a schedule from the recording schedule window

### To set up a daily recording schedule:

1. Select a camera.
2. Check the **Enable Recording** box to indicate that video from this camera is to be recorded.
3. Click a record type in the legend to activate that record type. The cursor changes to a pen and a yellow box appears around the schedule map.

4. Drag the pen cursor across desired hours and days in the schedule overview to mark those times with that specific record mode. To mark areas with a different record type, click on a different record type to activate it.

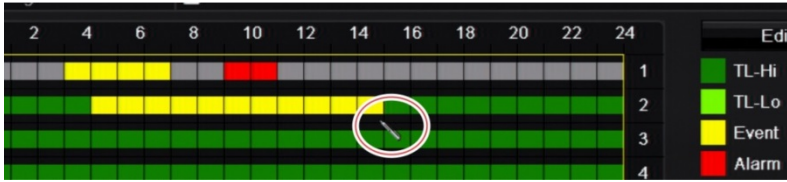

**Note:** You can schedule up to eight time periods in a day.

5. Click **Apply** to save the settings and **Exit** to return live view.

## Define a schedule from the Edit menu

To set up a daily recording schedule:

1. From the menu toolbar, click **Recording > Recording Schedule**.
2. Select a camera.
3. Check the **Enable Recording** box.
4. Click **Edit**. The following window is displayed:

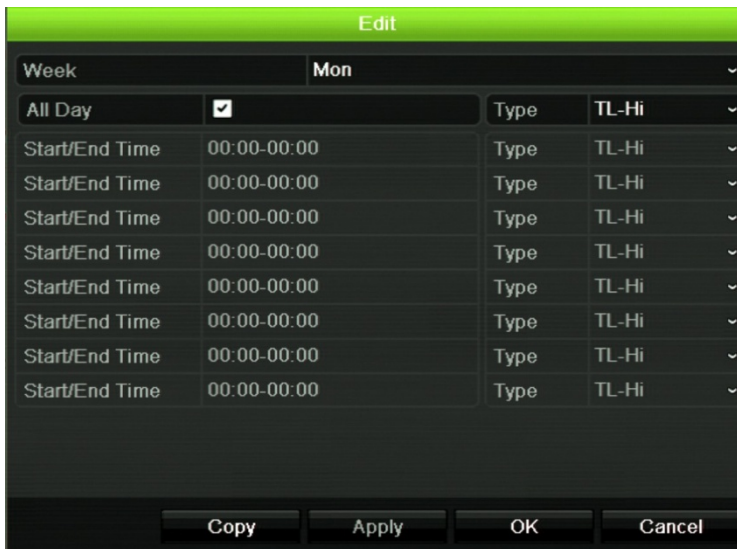

5. Select the day of the week for which you want to set up the schedule.

You can define a different schedule for each day of the week.

6. Set the start and end time for recording.

Define a time period by entering a start (left column) and end (right column) time. You can schedule up to eight time periods. Click **All Day** to record all day.

**Note:** Time periods defined cannot overlap.

7. Select a recording type.

This setting instructs the recorder to begin recording when an alarm is triggered.

The recording type can be based on time and triggered by motion detection and/or an alarm. If set to TimeLapse (TL-Hi or TL-Lo), the recorder records continuously.

8. Click **Apply** to save settings.

9. Repeat steps 4 to 8 for other days of the week or to copy the schedule settings to another day.

To copy the current schedule settings to another day of the week, click **Copy**. Select the number of the day of the week to which to copy the schedule. Click **OK** to save changes and return to the Edit window.

10. Repeat steps 4 to 9 for the other cameras.

11. Click **Apply** to save the settings and **OK** to return to the schedule window.

The recording schedule window appears showing the schedule selected (see Figure 25 on page 85 for an example).

## Modify the instant playback duration

The live view toolbar in live view lets you quickly play back recorded video for a preprogrammed period. You can easily change this preprogrammed time period. See page 24 for more information on the live view toolbar.

To modify the preprogrammed time of this instant playback go to **Recording > General**. Select one of the times from the drop-down list (5, 10, 20, or 30 minutes) and click **Apply**. Default is 5 minutes.

## Manual recording

The recorder lets you manually record video during live view. This can be useful if you know that the recorder is not currently recording and you see something of interest on a camera screen that should be recorded.

Once a manual recording is started, the recording continues until it is manually stopped. If an alarm occurs during a manual recording, the alarm recording has priority over the manual recording. If a scheduled recording is already in progress when a manual recording is started, it continues to record as scheduled.

You can check to see if a camera is recording manually by looking at the icon on the live view toolbar. The icon is red when manually recording. Default is off.

There are two ways to start and stop a manual recording:

- **Use the live view toolbar**

You can start/stop manual recording for each camera individually. Position the cursor over a camera image and left-click the mouse to display the live view toolbar. Click the manual record icon to start or stop manual recording. The icon is red when recording.

- **Use the configuration menu**

This option lets you select more than one camera at a time. Go to **Recording > Manual Recording** to access the manual recording menu and check the boxes of the cameras to start or stop manual recording.

## Hot Spare

You can set up a spare recorder to act as a slave unit (hot spare) for up to four TVN 22(S/P) master units. This slave unit will continually monitor the master units and if one of the master units should fail, it can then take over recording until the failed unit comes back online. Once the failed unit is back operating normally again, the slave unit will send its recordings to the HDDs of the recovered unit so that no recordings are missing.

The hot spare unit can only back up one master unit at a time. If more than one unit should fail, the hot spare unit will only backup the unit that failed first.

All units must have the same number of channels.

You cannot mix TVN 22 and TVN 22P units.

---

**WARNING:** Camera connected to the TVN 22S as PoE ports cannot be included in a hot spare function.

---

In order to have the failover functionality working properly, the following points must be taken into account:

- A stable network connection is required
- There must be at least 10 Mbps of unallocated bandwidth available with the main recorder. The main and failover recorders must have equal camera counts
- Ideally the failover recorder must have equal storage capacity to the main recorder to accommodate for long outage times of the main recorder.

### To set up a hot spare recorder:

1. From the menu toolbar, click **Recording > Hot Spare**.
2. First set up the master recorders.

For each master recorder, check the **Normal Mode** box and **Enable**. Enter the IP address and password for each recorder.

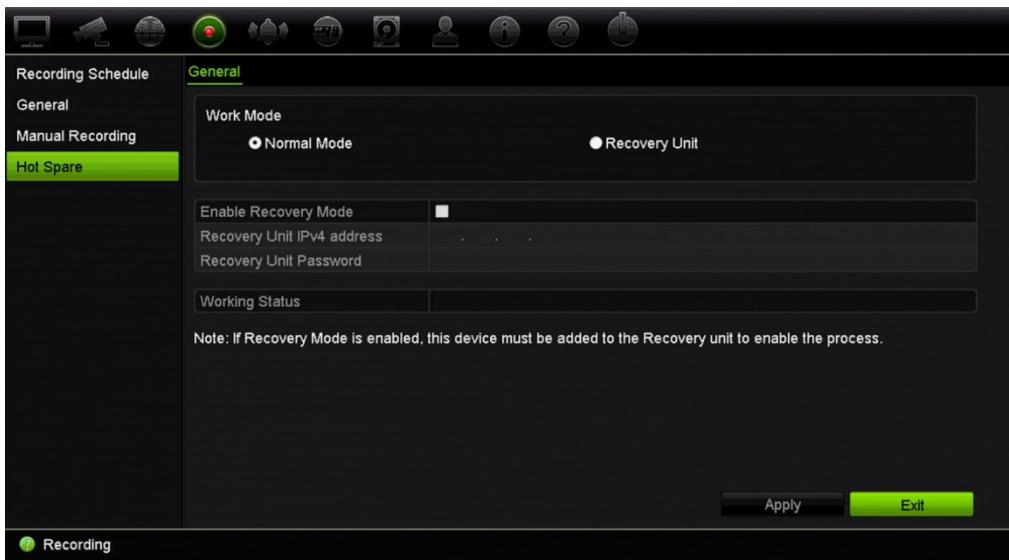

3. Set up the hot spare recorder.

Check the **Recovery Unit** box.

**Note:** Once the hot spare is enabled, it must be added to the server in order for it to become available.

4. Click **Apply** to save the settings.
5. Click **Exit** to return to live view, or continue configuring the recorder settings.

## SD card recording

Recording is normally done on the local HDD of the recorder. However, when there is a communication problem between the camera and the recorder (for example, the link fails), the images from the camera cannot be stored on the recorder HDD. Instead they can be recorded on the internal SD memory card in the camera. The camera must still be operational and connected to the network.

**Note:** This SD recording option is only available when the camera is equipped with an SD card.

The recording on the SD card starts with the pre-event image memory buffer 15 seconds in advance (default pre-event time is 15 s) and it continues until the connection is re-established. The recording also includes the post-event time image memory buffer (default post-event time is 10 s). Post-event is the time of the image memory buffer length after re-establishing the connection between the camera and the recorder.

When the connection between recorder and camera is re-established, the recorded images on the SD memory card are automatically copied to the recorder and stored on the HDD. The recorded images are inserted where the recorder stopped recording. Consequently, in playback mode, there are no missing or lost images.

When you play back the recordings directly from the SD card, they are marked as "Schedule" in the camera recording. See Figure 26 on page 90.

Figure 26: SD card image recording in playback



Prior to setting up the SD recording function, the SD card must be installed and initialized (formatted) in the camera. No further setup is required in the camera as the recorder takes control of the camera.

#### To set up SD card recording:

1. Go to the **Configuration** menu of the browser.
2. In **Camera Setup**, add the desired camera (correct password and login).
3. Click **Recording > Recording Schedule**.
4. Select the desired camera.
5. Check **Enable Recording** (eventual set time schedule, if desired).
6. Click the **Advanced** button to open the **Advanced** menu.
7. Check **Enable EFR (Edge Failover Recording)**.

When a camera is offline, it will record on its own SD card. This video will then be synchronized to the recorder HDD when the camera becomes online again.

8. Click **OK** to return to the “Recording Schedule” menu.
9. Click **Save** to save the changes and return to live view.



# Chapter 13

## Alarm and event setup

This chapter describes the alarm and event setup menu and provides more information on the different types of alarms and connected responses. Alarms are all notifications related to either physical alarm inputs on recorders and cameras or anything that does not work as expected: device errors, network issues, and video loss.

### Set up alarm inputs

The recorder can be configured to record when an alarm is triggered by an external alarm device (for example, PIR detector, dry contacts...). They are the physical inputs on the IP cameras and recorder.

#### To set up external alarms:

1. From the menu toolbar, click **Alarm & Event Setup > Alarm Input**.

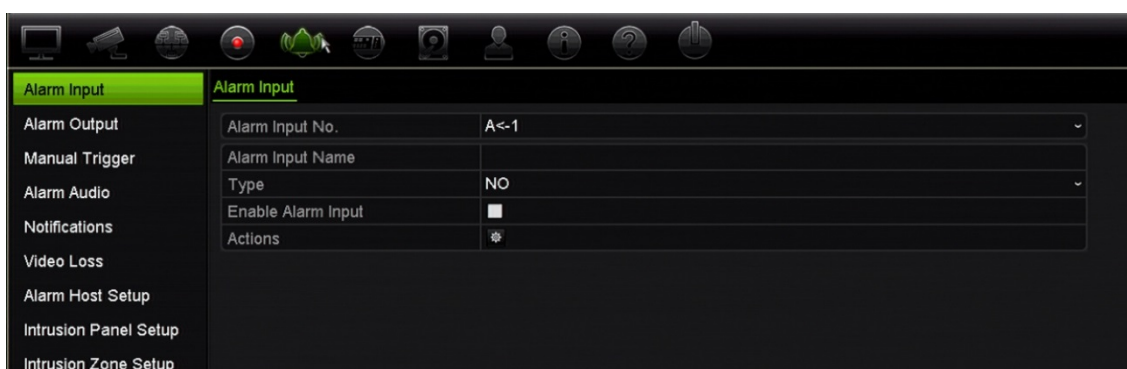

2. Select the alarm input number of a camera, which corresponds to the connector on the back panel of the recorder, and enter the name of the input, if required.
3. Select the alarm input type, NO (normally open) or NC (normally closed). Default is NO.
4. Check the **Enable Alarm Input** box and click **Actions** to set up the rules for the cameras to be triggered, their alarm schedules, method of alarm notification and PTZ linking function.
5. Select the cameras to be triggered when an external alarm is detected.

In the Actions window, click the **Trigger Channel** tab and then select the cameras to be triggered for recording when an alarm is detected. Click **Apply** to save the settings.

6. Select the recording schedules for the external alarm.

In the Actions window, click the **Arming Schedule** tab and select the day of the week and the time periods during the day when motion can be recorded. You can schedule up to eight time periods in a day. Default is 24 hours.

Click **Apply** to save the settings. Click **Copy** to copy these settings to other days of the week.

**Note:** The time periods defined cannot overlap.

7. Select the response method to an external alarm.

In the Actions window, click the **Actions** tab to define the method by which you want the recorder to notify you of the alarm. Select one or more of the alarm notification types. See “Alarm response actions” below for the list of actions available.

Click **Apply** to save the settings. Click **OK** to return to the previous window.

8. Select the PTZ camera function required in response to an external alarm.

In the Actions window, click the **PTZ Linking** tab. Select the PTZ camera and enter the preset, preset tour or shadow tour that is triggered when the alarm is detected.

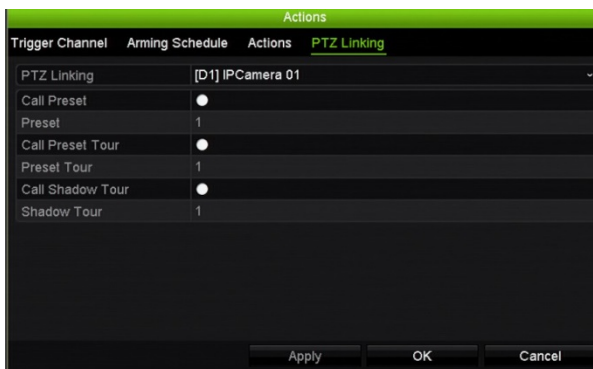

Click **Apply** to save the settings.

9. Click **OK** to return to the alarm input window.
10. Click **Exit** to return to live view.

## Alarm response actions

When setting up the rules for alarm detection, you can specify how you want the recorder to notify you about an alarm or event. You can select more than one notification type.

Not all alarm response actions are available for all types of alarms.

The alarm response actions are:

- **Full-screen monitoring:** When an alarm is triggered, the monitor (VGA or HDMI) displays an image in live view mode. For alarms that are triggered simultaneously, images display one at a time every 10 seconds (default dwell time). You can set a different dwell time using the “Dwell Time” setting under the Display Settings>Layout window. When the alarm stops, cycling of the images stops and you return to live view mode. This alarm option must be selected for each channel where it is required.
- **Enable Alarm Audio:** Triggers an audible beep when an alarm or event is detected by the system or a camera.
- **Notify Alarm Host:** Sends a signal to TruVision Navigator or other software applications when an alarm or event is detected.
- **Send Email:** Sends an email when an alarm or event is detected. See “Email settings” on page 79 for information on how to configure the recorder to send an email.
- **Upload Snapshots to FTP:** Capture the image when an alarm is triggered and upload the picture to NAS or FTP server.
- **Play Audio File:** Triggers an alarm audio file when a notification or alarm is detected by the system or a camera. See “Alarm Audio” on page 94 for further information.
- **Trigger Alarm Output:** Triggers an alarm output or multiple alarm outputs when a notification is detected for an external alarm. See “Set up alarm outputs” below for information on configuring an alarm output.

## Set up alarm outputs

You can connect the recorder to an alarm system, such as a siren or intrusion system, which is then activated when an alarm is triggered. You can select how long the alarm signal remains active as well as schedule when alarm outputs can be triggered. “A” outputs are marked A for analog and are physical outputs of the recorder. “D” outputs are marked as D for digital and are physical outputs on the IP cameras.

### To set up an alarm output:

1. From the menu toolbar, click **Alarm & Event Setup > Alarm Output**.
2. Select the alarm output.
3. Select a timeout option between 5 and 600 seconds or select “Manually Clear”.

The timeout setting lets you define how long an alarm signal remains active after the alarm has ended. If you select **Manually Clear**, the alarm signal remains active until it is manually acknowledged by pressing the alarm button on the front panel or remote control (see “Manual trigger” on page 94).

4. Select the recording schedules for the alarm output.

Click the **Actions** button and select the day of the week and the time periods during the day when motion can be recorded. You can schedule up to eight time periods in a day. Default is 24 hours.

Click **Apply** to save the settings. Click **Copy** to copy the settings to other days of the week and holiday period.

**Note:** The time periods defined cannot overlap.

Click **OK** to return to the alarm output window.

5. Click **Copy** to copy these settings to other cameras, if required, and then click **Apply** to save the changes.
6. Click **Exit** to return to live view.

## Manual trigger

The manual trigger menu allows you to manually trigger outputs of the recorder.

### To trigger or clear alarm outputs manually:

1. From the menu toolbar, click **Alarm & Event Setup > Manual Trigger**.
2. Select the desired alarm output and click the following buttons:

**Trigger / Clear:** Trigger an alarm output or stop an alarm output. As there is only one alarm output available, the “Trigger All” button just triggers the one output.

**Clear All:** Stop all alarm outputs at once.

3. Click **Exit** to return to live view. The alarm is silenced.

- Or -

Press the Alarm button on the front panel or remote control. The alarm is silenced.

## Alarm Audio

The Alarm Audio menu allows you to review and edit recorded audio files.

You can record customized audio messages and upload them onto the recorder to be played back when an alarm is triggered. Up to 16 audio files can be stored on the recorder, including five sample audio file provided by the recorder. The message can be up to 20 seconds long and up to 60 kb in file size. Preferred audio file types are G7.11 and WAV.

The administrator uploads the audio files onto the recorder using a web browser or an application supported by the SDK. There are five sample audio files provided in English:

- An alarm has been triggered. Please leave the premises immediately.

- An alarm has been triggered. The police have been notified.
- These premises are monitored by video surveillance.
- You have entered a restricted area. Please exit this area immediately.
- Security breach. The alarm has been triggered.

#### To import an alarm audio file:

1. From the menu toolbar, click **Alarm & Event Setup > Alarm Audio**.

**Note:** To modify the name of an audio file, click **Edit** for the desired file and enter the new file name.

2. Click **Import** to import a file. The following screen appears:
3. Under **Device Name**, select the storage device.
4. Under **Import to**, select the audio file number, select the audio file in the file list, and then click **Import** to return to the Alarm Audio screen.

**Note:** As there are already five sample audio files provided, up to 11 audio files can be imported.

#### To delete an alarm audio file:

1. From the menu toolbar, click **Alarm & Event Setup > Alarm Audio**.
2. Select the file to be deleted, and click **Delete**.

**Note:** There will always be a minimum of five audio files listed.

## Event notifications

You can select the alarm and event notifications to be included in the event hint icon of the alarm center displayed in live view. Clicking the icon opens the window of the alarm center that lists the detected alarm and event notifications. See “Status information” on page 21 for information on the status icon displayed in the OSD.

The different types of events notifications are:

- **HDD Full:** All installed HDDs are full and will not record any more video.
- **HDD Error:** Errors occurred while files were being written to the HDD, there is no HDD installed, or the HDD had failed to initialize.
- **Network Disconnected:** Disconnected network cable.
- **Duplicate IP Address Found:** There is an IP address conflict with another system on the network.
- **Illegal Login:** Wrong user ID or password used.
- **Abnormal Record:** HDD cannot record any more files. This could be due to the overwrite option being disabled so recorded files are locked and cannot be deleted.
- **Hot Spare Exception:** Errors occurred with hot spare HDD.

- **PoE Power Overload:** PoE power overload detected (TVN 22S only).
- **Video Loss:** The video image is lost. Video may be lost if the camera develops a fault, is disconnected, or is damaged.
- **Alarm Input Triggered:** An alarm triggered by an external alarm device (for example, PIR detector, dry contacts...)
- **Camera Tamper Detected:** The camera view has changed. For example, someone has deliberately blocked the camera view by spraying paint on the lens or by moving the camera
- **Motion Detected:** Motion is detected.
- **IP Camera Address Conflicted:** Conflict in IP address setting.
- **Resolution or Bitrate of Substream Not Supported**
- **Cross Line Detected:** People, vehicles and objects have been detected crossing a pre-defined line or an area on screen.
- **Perimeter Intrusion Detected:** Someone has been detected entering a pre-defined area in the surveillance scene.
- **Audio Input Exception:** A camera has detected sounds that are above a selected threshold.
- **Sudden Change of Sound Intensity:** A camera has detected a sudden change in the sound intensity.
- **Face Detected:** A camera has detected that a human face is moving towards it.
- **Defocus Detected:** There is image blur caused by defocusing the lens.
- **Sudden Scene Change:** A camera has detected a change in the scene caused by an intentional rotation of the camera.
- **Enter Region Detected:** A camera has detected that an object, such a vehicle, people or other objects, has entered a designated region.
- **Exit Region Detected:** A camera has detected that an object, such a vehicle, people or other objects, has exited a designated region.
- **Leave Behind:** A camera has detected that an object has been left in a designated region, such as baggage.
- **Object Removed:** A camera has detected that an object has been removed from a designated region, such as exhibits on display.
- **R/W HDD is 95% full:** The R/W HDD is nearly full.
- **All HDDs are full.**
- **Heartbeat Alarm:** This is an OH event. There is no communication between the intrusion panel and the recorder.
- **Arming Alarm:** This is an OH event. The intrusion panel has been armed.
- **Disarming Alarm:** This is an OH event. The intrusion panel has been disarmed.

- **Intrusion Alarm:** This is an OH event. An intrusion alarm has been triggered by the intrusion panel.

#### To set up event notifications:

1. From the menu toolbar, click **Alarm & Event Setup > Notifications**.
2. Check **Display Event Icon** so that the event icon appears in the OSD in live view when an alarm or event is triggered (default is enabled).
3. Under **Event Hint Settings**, click the Actions button. From the drop-down list, select the desired event notifications to be listed in the alarm center in live view and click **OK**. See “Event notifications” on page 95 for the complete list.
4. Select the event priority: VCA < Motion or VCA > Motion. Default is VCA < Motion, where motion has priority over VCA.
5. Select a technical event notification and how the recorder should respond to it.

Under **Notification Type**, select the desired technical event notification:

- **HDD Full:** All installed HDDs are full and will not record any more video.
- **HDD Error:** Errors occurred while files were being written to the HDD, there is no HDD installed, or the HDD had failed to initialize.
- **Network Disconnected:** Disconnected network cable.
- **Duplicate IP Address Found:** There is an IP address conflict with another system on the network.
- **Illegal Login:** Wrong user ID or password used.
- **Abnormal Record:** HDD cannot record any more files. This could be due to the overwrite option being disabled so recorded files are locked and cannot be deleted.
- **Hot Spare Exception:** Errors occurred with hot spare HDD.
- **PoE Power Overload:** PoE power overload detected (TVN 22S only).

Check one or more response method: Enable Alarm Audio, Notify Alarm Host, Send Email, and Trigger Alarm Output.

**Note:** The list of response methods available depends on the notification type selected.

6. Repeat step 5 for other notification types.
7. Click **Apply** to save the settings.
8. Click **Exit** to return to live view.

## Detect video loss

Video may be lost if the camera develops a fault, is disconnected, or is damaged. You can set up the recorder to detect video loss and trigger a system notification.

### To setup video loss detection:

1. From the menu toolbar, click **Alarm & Event Setup > Video Loss**.
2. Select a camera to configure for video loss detection.
3. Check the **Enable Video Loss Alarm** box to enable the feature.
4. Click the **Actions** button to enter the Actions window.
5. Set the arming schedule for detecting video loss.

Click the **Actions** tab and select the schedule of when you want video loss detection to be enabled. The schedule can be set for all week or any day of the week with up to eight time periods per day. Click **Apply** to save the settings.

6. Select the alarm response method.

Click the **Arming Schedule** tab and select how you want the recorder to notify you of video loss. Select one or more options: Full-screen Monitoring, Enable Alarm Audio, Notify Alarm Host, Send Email, and Trigger Alarm Output. See page “Alarm response actions” on page 92 for the descriptions. Click **Apply** to save the settings.

7. Click **OK** to return to the main window
8. Click **Copy** to copy these settings to other cameras, if required, and then click **Apply** to save the changes.
9. Click **Exit** to return to live view.

## Alarm host setup

If an alarm host is set, the recorder sends a signal to the host when an alarm is triggered. An example of an alarm host is the TruVision Navigator server. Note that alarm host applications need to have the TruVision recorder SDK implemented in order to successfully receive notifications from the recorder.

### To set up an alarm host:

1. From the menu toolbar, click **Alarm & Event Setup > Alarm Host Setup**.
2. Enter Alarm Host IP and Alarm Host Port values.

Alarm host IP represents the IP of the remote PC where the Network Video Surveillance software installed. The alarm host port value must be the same as software’s alarm monitor port. Up to three alarm hosts can be set. For each alarm host, the default port is 5001, 5002, and 5003.





3. Click **Apply** to save the settings.
4. Click **Exit** to return to live view.

## OH alarm reporting

The recorder includes the Osborne Hoffman (OH) alarm receiver software module. This permits SIA and XSIA events to be reported to the recorder from Interlogix intrusion panels via IP and to be linked to recorder actions.

The following Interlogix panels are supported:

- ATS Master (EMEA only)
- Advisor Advanced
- NetworX panels

Up to three intrusion panels can be set up in the recorder. Each panel can report up to 32 intrusion zones (a zone is an intrusion panel input).

The panels must support the SIA or XSIA reporting protocol. They can report the following alarm types to the recorder:

- An arming event
- A disarming event
- An alarm event that has an "A" as a second character in the SIA/XSIA code
- A heartbeat alarm

In the intrusion panel, set up the recorder as a normal monitoring station. Use OH version 3.

### To set up an alarm panel in the recorder:

1. From the menu toolbar, click **Alarm & Event Setup > Intrusion Panel Setup**.
2. In the Intrusion Panel Setup window, enter the required settings.



Option	Description
Set up the intrusion panel connection parameters:	
1. Enable Intrusion Panel Connection	Check this box to enable the intrusion panel connection.
2. Select Intrusion Panel	Select which panel you want to set-up. Up to three panels can be set up.
3. Name Intrusion Panel	Enter a name for the panel.
4. Number Of Zones	Up to 32 panel zones can report to the recorder. The number cannot be increased but you can allocate a different ID for each zone under the "Intrusion Zone Setup" menu.
5. IP Address Intrusion Panel	Enter the panel's IP address. The IP address must be in the same LAN as the recorder.
6. Server Port	Enter the port that is used to report the events. Default is 9999. This port number must match the port number set up in the intrusion panel.
Set up the heartbeat alarm parameters:	
7. Enable Panel Heartbeat Alarm	Check this box to enable the panel heartbeat alarm. The heartbeat alarm will then be reported to the recorder.
8. Heartbeat Interval (s)	Enter the interval between two heartbeats. It is measured in seconds. When the heartbeat is not received within this interval, an action can be taken for the heartbeat alarm.
Actions	Click the icon to set up the actions linked to the panel heartbeat alarm. Go to step 3.
Set up the panel arming alarm parameters:	
10. Enable Panel Arming alarm	Check this box to enable the panel arming event. When the panel is armed, it will be reported to the recorder.
11. Actions	Click the icon to set up the actions linked to the panel arming alarm. Go to step 3.

Option	Description
Set up the panel disarming alarm parameters:	
12. Enable Panel Disarming Alarm	Check this box to enable the panel disarming event. When the panel is disarmed, it will be reported to the recorder.
13. Actions	Click the icon to set up the actions linked to the panel disarming alarm. Go to step 3.

3. To define the actions for the heartbeat, panel arm and panel disarm alarms that are reported by the intrusion panel, click **Action** and each of the tabs:

**Trigger Channel:** Select the cameras that will be recorded when an alarm event is received. The cameras will be recorded following the main stream (alarm) parameters. The recordings will be 10 seconds for each assigned camera.

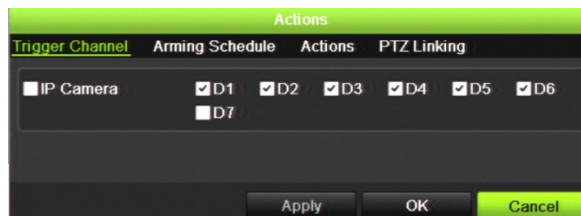

**Arming Schedule:** Define the alarm schedule for the actions. You can schedule up to eight periods in a day. Default is 24 hours.

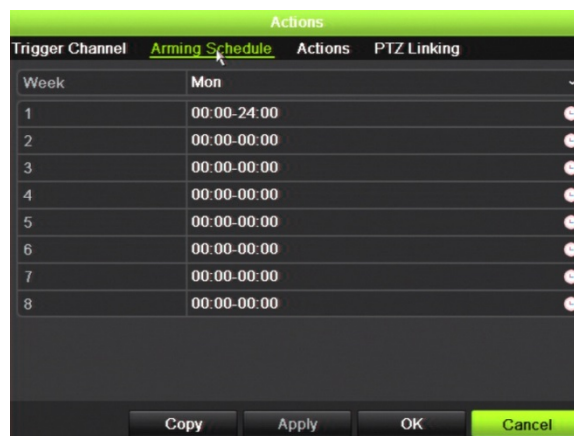

**Actions:** Check the required action that needs to be executed when an alarm is received:

- Enable an alarm audio (buzzer)
- Notify the alarm host (supported by TruVision Navigator 6.1)
- Trigger an alarm output

**PTZ Linking:** Select the PTZ camera as well as the preset, preset tour, or shadow tour that is triggered when the alarm/event is detected.

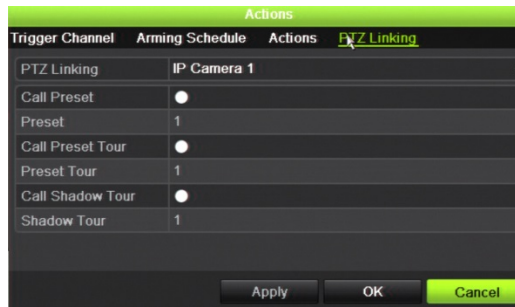

Click **Apply** to save the settings. Click **OK** to return to the main window.

4. Click **Apply** to save the intrusion panel setup parameters.
5. Click **Exit** to return to live view.

**To set up the zones in an alarm panel:**

1. From the menu toolbar, click **Alarm & Event Setup > Intrusion Zone Setup**.
2. Under **Select Intrusion Panel**, select intrusion panel 1, 2 or 3.
3. Select the desired ID of a zone. The maximum is 32. The number does not have to match the zone number.
4. Under **Zone Number**, select the desired zone number. The zone number can be any valid number of the panel, which does not need to match the zone number.
5. Click **Action** to define the actions for the selected zone number.

**Trigger Channel:** Select the cameras that will be recorded when an alarm event is received. The cameras will be recorded following the main stream (alarm) parameters. The recordings will be 10 seconds for each assigned camera.

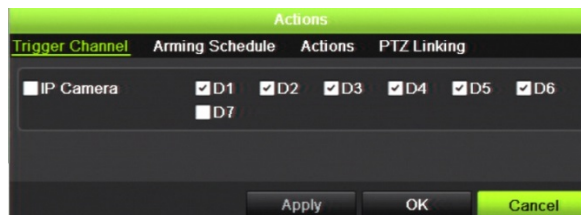

**Arming Schedule:** Define the alarm schedule for the actions. You can schedule up to eight periods in a day. Default is 24 hours.



**Actions:** Check the required action that needs to be executed when an alarm is received:

- Enable an alarm audio (buzzer)
- Notify the alarm host (supported by TruVision Navigator 6.1)
- Trigger an alarm output

**PTZ Linking:** Select the PTZ camera as well as the preset, preset tour, and/or shadow tour that is triggered when the alarm/event is detected.

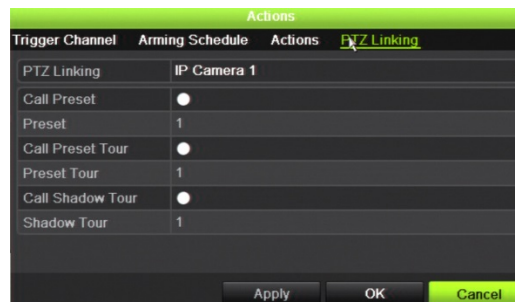

Click **Apply** to save the settings. Click **OK** to return to the main window.

6. Click **Apply** to save the intrusion panel setup parameters.
7. Click **Exit** to return to live view.

## TVRMobile push notifications

TVRMobile 2.3 (and higher) can receive events from a TVN 22 recorder.

### To set up push notifications:

1. In TVRMobile, add the recorder.
2. Switch on the **Alarm Push Notifications** feature for the recorder.

The events will be listed in the *Alarm Information* window.

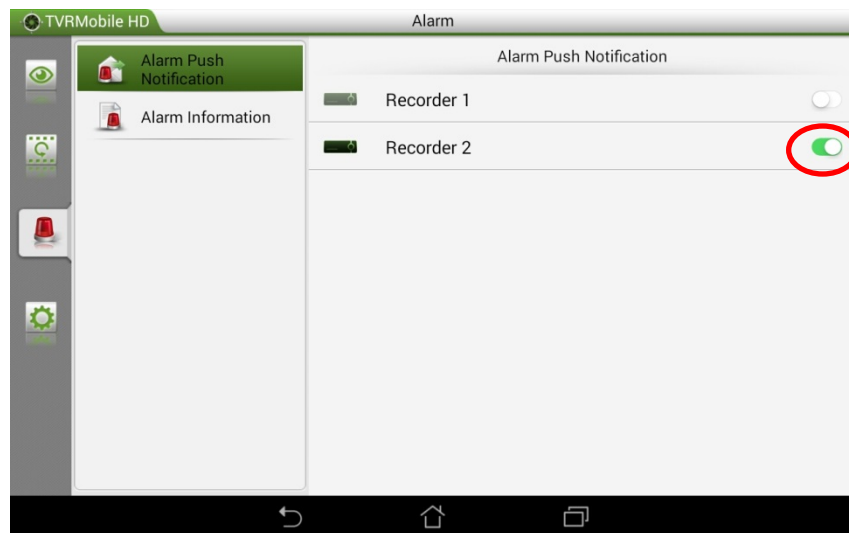

3. For the events that you want to see in the mobile app, select **Notify Alarm Host** as an action in the recorder.

As soon as an event happens, the event will appear in the mobile app and a notification will be shown.

# Chapter 14

## Device management

This chapter describes how to:

- Set up the time and date of the recorder
- Select the recorder language and set up general system parameters such as the device name, menu timeout period, and enable/disable password requirement
- Import/export configuration files
- Upgrade the firmware
- Set up holiday periods
- Configure RS-232 settings

### Time and date settings

You can set up the date and time that will appear on-screen as well as on time stamped recordings. The start and end time of daylight saving time (DST) in the year can also be set. DST is deactivated by default. See Figure 27 on page 106 for the Time settings screen.

**Figure 27: Time and date settings window**



**Table 15: Description of the Time and Date settings window**

Option	Description
1. Time Zone	Select a time zone from the list.
2. Date Format	Select the date format from the drop-down list. Default format is DD-MM-YYYY.
3. Time Format	Select either the 12-hour or 24-hour time format from the list. Default format is 24-hour format.
4. Display Day	Check to display the day of the week in the monitor time bar. Check the box to enable/disable. Default is Disable.
5. System Date	Enter the system date. Default date is the current date.
6. System Time	Enter the system time. Default time is the current time.
7. Auto DST Adjustment	Enable to activate DST is automatically. It depends on the time zone selected. Default is Disable.
8. Enable DST	Manually define DST. If this option is selected, the <i>Auto DST adjustment</i> option is disabled. Default is Disable. Click the check box to enable or disable daylight savings time (DST).
From	Enter the start date and time for daylight savings.
To	Enter the end date and time for daylight savings.
DST Bias	Set the amount of time to move DST forward from the standard time. Default is 60 minutes.



## General recorder settings

Use the General Settings menu of Device Management to configure general recorder options.

See Figure 28 and Table 14 on page 107 for the general options available. The changes are immediately implemented once Apply is clicked to save the settings.

**Figure 28: General settings of the recorder**



**Table 16: Description of the Monitor setup window: General settings**

Option	Description
1. Language	Define the language of the system. Select the desired language from the drop-down list and click <b>Apply</b> . The language displayed changes immediately. Default is English.
2. Device Name	Define the recorder name. Click the edit box and enter the new name from the soft keyboard.
3. Remote Control ID	The device number to use for the recorder when linking the device to a remote control. The default value is 255.
4. Keypad Zone ID	The Keypad Zone ID number.
5. Menu Timeout	Define the time in minutes after which the menu window reverts to live view mode. Select a time from the drop-down list, and click <b>Apply</b> . Menu timeout also applies to the system idle time after which a password will be required. Default value is 5 minutes.
6. Output Mode	Select from Auto, HDMI, and VGA.

Option	Description
7. Mouse Pointer Speed	Modify the speed of the mouse pointer. Adjust the scroll bar point to the desired level and click <b>Apply</b> . Default is the slowest of the four speeds.
8. Enable Wizard	Immediately start Wizard without rebooting the system. Check the box to enable/disable and click <b>Apply</b> . Default is Enable.
9. Start Wizard Now	Reboot the system immediately and start Wizard. Default is Disable.
10. Password Required	Define whether a login password is required to open the menu. Check the box to enable/disable and click <b>Apply</b> . Default is Disable.
11. Enable Front Panel Lock	When the system logs out, the front panel is automatically locked. When enabled, to unlock the front panel, press the Live button for 5 seconds. Default is Disable.

## Configuration files

You can export and import configuration settings from the recorder. This is useful if you want to copy the configuration settings to another recorder, or if you want to make a backup of the settings.

### Import and export files

Insert an external storage device in the recorder. Go to the **Device Management > Configuration Files** to import or export configuration settings. Click **Export** to export the recorder's configuration settings into an external storage device or click **Import** to import configuration settings after selecting a configuration file from the external storage device.

### Restore default settings

The administrator can reset the recorder to the factory default settings. Network information such as IP address, subnet mask, gateway, MTU, NIC working mode, server port, and default route are not restored to factory default settings

#### To restore parameters to default factory settings:

1. From the menu toolbar, click **Device Management > Configuration Files**.

**Note:** Only the administrator can restore the default settings.

2. To restore all parameters to default factory settings:

Click the **Default** button. Enter the Admin password, click **OK**, and then click **Yes** to confirm that you want to restore all parameters to default.

— Or —

To restore all parameters, except network settings, to default factory settings:

Click the **Restore** button. Enter the Admin password, click **OK**, and then click **Yes** to confirm that you want to restore all parameters except network settings to default.

3. Click **OK** to confirm you want to restore default settings.

## Upgrade system firmware

The firmware on the recorder can be updated using three methods:

- Via a USB device
- Via the recorder web browser
- TruVision Navigator. For further information, refer to the TruVision Navigator user manual.

The firmware upgrade file is labeled *TVN22.dav*.

### To update the system firmware using a USB device:

1. Download the latest firmware from our web site at:  
[www.interlogix.com](http://www.interlogix.com)
2. Connect the USB device to the recorder.
3. From the menu toolbar, click **Device Management > Upgrade Firmware**.  
The list of files on the USB is displayed.
4. Select the firmware file and click **Upgrade**. Click **Yes** to begin the upgrade process.
5. When the upgrade process is completed, reboot the recorder. The recorder does not reboot automatically.

## Holiday schedules

It is possible to indicate holidays for which you can create a separate recording schedule. Once one or more holidays are created, a separate entry for holiday will be included in the recording schedule (refer to “Recording schedule” on page 84 of the manual)

### To set up a holiday recording schedule:

1. From the menu toolbar, click **Device Management > Holiday**.
2. Select a holiday period from the list and click its **Edit** button to modify the settings. The Edit window appears.
3. Enter the name of the holiday period and click **Enable**.
4. Select whether the holiday period will be categorized by date, week, or month and then enter the start and end dates.
5. Click **Apply** to save the settings and then **OK** to return to the Edit window.
6. Repeat steps 2 to 5 for other holiday periods.
7. Click **Exit** to return to live view.

## RS-232 settings

Use the **Device Management** menu to configure the RS-232 parameters such as baud rate, data bit, stop bit, parity, flow control, and interface.

**Figure 29: RS-232 setup window**



## Using a network storage system

You can use a network storage system (NAS) or storage area network (SAN) to remotely store recorder recordings.

The recommended brands of storage system to use are:

- Seagate BlackArmor NAS 220
- Iomega StorCenter ix2-dl
- NETGEAR ReadyNAS Pro 2

- QNAP TS-219 II Turbo NAS

**To set up a network storage system:**

1. Click the **Configuration** tab in the browser toolbar and then select **Network Settings > Network Storage**.
2. Under **Server IP**, enter the IP address of the desired remote storage system.
3. Under **File Path**, enter the file path name to define where on the remote storage system you want to store the files.

**Note:** If using the NAS storage systems Seagate BlackArmor NAS 220 or Iomega StorCenter ix2-dl, you must add the prefix “/nfs” to the NAS path.

4. Under **Type**, select type of storage system to be used: NAS or SAN. Default is NAS.
5. Up to eight remote storage systems can be set up.
6. Click **Save**.

# Chapter 15

## Storage management

This chapter describes the content of the Storage Management menu, including HDD information, Storage Mode, S.M.A.R.T. settings as well as bad sector detection and RAID.

### HDD information

You can check the status of any of the installed HDDs on the recorder at any time.

#### To check the status of a HDD:

1. From the menu toolbar, click **Storage Management > HDD Information**.
2. Note the status of the HDDs listed under the Status column.

If the status is listed as Normal or Sleeping, the HDD is in working order. If it is listed as Abnormal and has already been initialized, the HDD needs to be replaced. If the HDD is Uninitialized, you need to initialize it before it can be used in the recorder. Refer to “Initialize a HDD” on page 113 for more information.

**Note:** The status information is also shown in the **System Information > HDD** window.

Figure 30: HDD Information window



## Add a HDD

You can add additional network attached hard drives to setup a NAS or SAN system.

### To add a HDD:

1. From the menu toolbar, click **Storage Management > HDD Information**.
2. Click the **Add** button to begin.
3. Select a Network Storage name.
4. Select the network storage type. Select from NAS or IP SAN.
5. Enter the HDDs Storage IP address. Click the **Search** button to search for the Storage Directory.
6. Click the **OK** button to create the selected network attached storage.

## Initialize a HDD

The built-in HDD does not need to be initialized before it can be used. You can also re-initialize the HDD. However, all data on the HDD will be destroyed.

### To initialize a HDD:

1. From the menu toolbar, click **Storage Management > HDD Information**.
2. Under the HDD Information tab, select the HDD to be initialized.
3. Click the **Initialize** button to begin initialization.

After the HDD has been initialized, the status of the HDD changes from Abnormal to Normal.

## Overwrite a HDD

You can select how the recorder responds when the HDDs become full and there is no longer sufficient space to save new data. The overwrite option is enabled by default.

### To enable overwrite when the HDDs are full:

1. From the menu toolbar, click **Storage Management > HDD Information**.
2. Enable **Overwrite**. Default is Enable.

---

**Caution:** If the overwrite option is disabled and the quota management capacity for a channel is set to zero, the recordings on that channel can still be overwritten. To avoid this happening, set a quota level for the channel or use the group management mode.

---

3. Click **Apply** to save the settings.
4. Continue to configure the recorder or click **Exit** to return to live view.

## Storage mode

To ensure an efficient use of the storage space available on HDDs, you can control an individual camera's storage capacity using HDD quota management. This function lets you allocate different storage capacities for both recordings and snapshots to each camera.

**Note:** If the overwrite function is enabled, the maximum capacity for both recordings and snapshots is set to zero by default.

### To set the HDD quota for a camera:

1. From the menu toolbar, click **Storage Management > Storage Mode**.





2. Under the Mode option, select **Quota**.
3. Select a camera whose storage capacity you want to change and enter the values in GB for the maximum record capacity and snapshot capacities. The available quota space available is displayed on screen.
4. Click **Apply** to save the settings.
5. If you want to copy these values to other cameras, click **Copy** and select each camera individually. Click **OK**. Click **Apply** to save the settings.

## Group HDDs

Your recorder can organize multiple HDDs into groups. Videos from specified channels can be set to be recorded onto a particular HDD group. You could, for example, save the recordings from a couple of high priority cameras to one HDD, and save the recordings from all the other cameras to another HDD.

### To set up an HDD group:

1. From the menu toolbar, click **Storage Management > Storage Mode**.
2. Under **Mode**, select **Group**.
3. Under **Record on HDD Group**, select a number for the HDD group.
4. Check the channels to be added to this group.
 

**Note:** By default, all channels belong to HDD group 1.
5. Click **Apply** to save the settings.
6. Continue to configure the recorder or click **Exit** to return to live view.

## Create HDD groups

If you have more than one HDD installed, you can change the behavior of a HDD by changing its property. It can be set to read-only or read/write (R/W). The storage mode must be set to *Group* before setting the HDD property.

A HDD can be set to read-only to avoid important recorded files from being overwritten when the HDD becomes full.

### To change a HDD status property:

1. From the menu toolbar, click **Storage Management > HDD Information**.
2. Select the HDD whose property you want to change.
3. Click the **Edit** icon . The **Local HDD Settings** window appears.
 

**Note:** The Edit icon is only available if there are at least two HDDs installed.
4. Click the desired HDD property for the selected HDD: R/W or Read Only.
5. Click the group number for this HDD.
6. Click **Apply** to save and exit the window.

**Note:** Once set to read-only, the HDD cannot be used to save recorded files until it is set back to read/write (R/W). If the HDD that is currently being written to is set to read-only, the data is then recorded to the next HDD. If there is only one HDD present, setting it to read-only means the recorder cannot record.

## Set up HDD sleep mode

You can set the HDD to enter standby mode, or sleep mode, after a period of inactivity. Sleep mode decreases the power consumption of a HDD.

### To enable HDD sleep mode:

1. From the menu toolbar, click **Storage Management > Storage Mode**.
2. Check **Enable HDD Sleeping** to enable sleep mode. Default is Enable.
3. Click **Apply** to save the settings.
4. Continue to configure the recorder or click **Exit** to return to live view.

## Managing eSATA

If you are using an external e-SATA device connected to the recorder, you can configure the e-SATA to record/capture or export video.

Select the Export option when using the eSATA as a backup. See “Quick Archive” on page 47 for further information.

Select the Record/Capture option to record and capture video. Information on the eSATA for this purpose can be seen under **System settings > Hard Disk > HDD Information**.

### To set up the e-SATA device:

1. Click the **Video Schedule** icon in the menu toolbar and select **More Settings**.
2. Under **eSATA**, select the desired option: **Record/Capture** or **Export**.
3. Click **Apply** to save the settings.

## S.M.A.R.T. settings

S.M.A.R.T. (Self-Monitoring, Analysis and Reporting Technology) reports on a variety of indicators of hard drive reliability while protecting video stored on the hard drive.

### To view the S.M.A.R.T. information of a HDD:

1. From the menu toolbar, click **Storage Management > S.M.A.R.T. Settings**.
2. Select the HDD whose data you want to see. A detail listing of S.M.A.R.T. information is displayed.



3. If you want to continue to use a HDD when the S.M.A.R.T. test has failed, check the box **Use when the disk has failed to self-evaluate**. Click **Apply** to save the settings.
4. Click **Exit** to return to live view.

## Bad sector detection

You can improve the performance of your HDDs by ensuring that they have no bad sectors. Bad sectors can slow down an HDD when reading or writing data, for example.

Figure 31: Bad sector detection window



### To detect bad sectors:

1. From the menu toolbar, click **Storage Management > Bad Sector Detection**.
2. Select the HDD you want to test.

3. Select whether you want to do a key area detection or a full detection, and click **Detect**.
4. The system checks the HDD. The color-coded result is displayed on screen. If there are bad sectors found, click **Error Info** to see a list of the errors found.
5. If required, click **Pause** to pause the test or **Cancel** to cancel it.
6. Click **Exit** to return to live view.

## RAID

RAID is data storage technology. It combines multiple disk drives into a single logical unit for the purposes of data redundancy or performance improvement.

### To create a RAID array:

1. Click the **Storage Management** icon in the menu toolbar and select **RAID**.
2. Click the **Enable RAID** checkbox.
3. Click **Apply** and then **Yes** to reboot the system.
4. Click the **Storage Management** icon in the menu toolbar and select **RAID**.

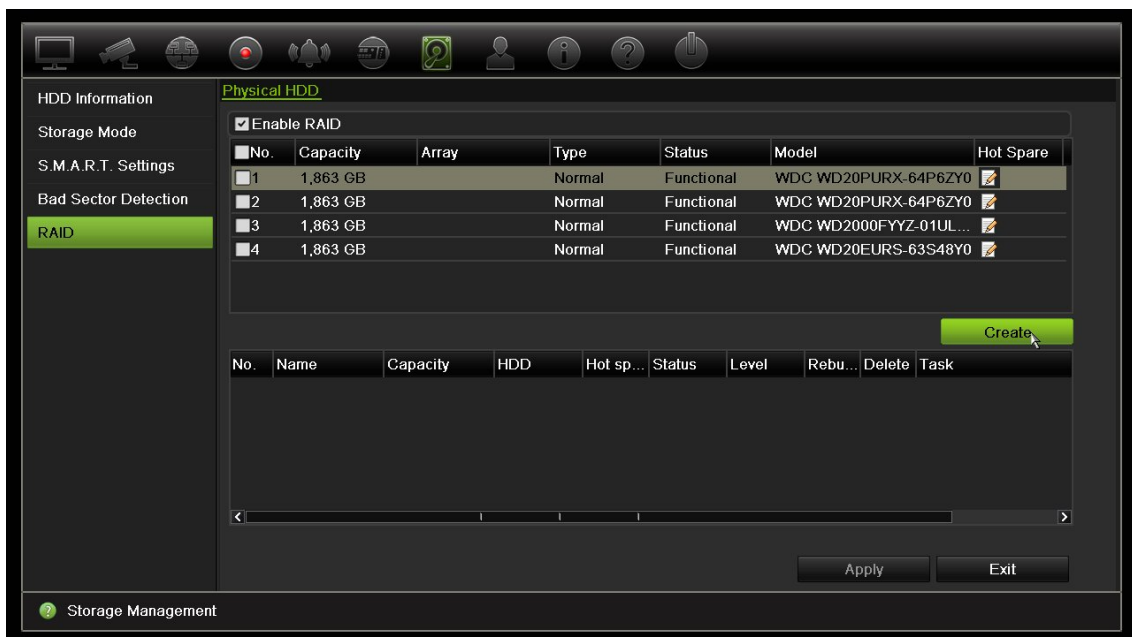

5. Click the **Create** button to open the *Create Array* window.

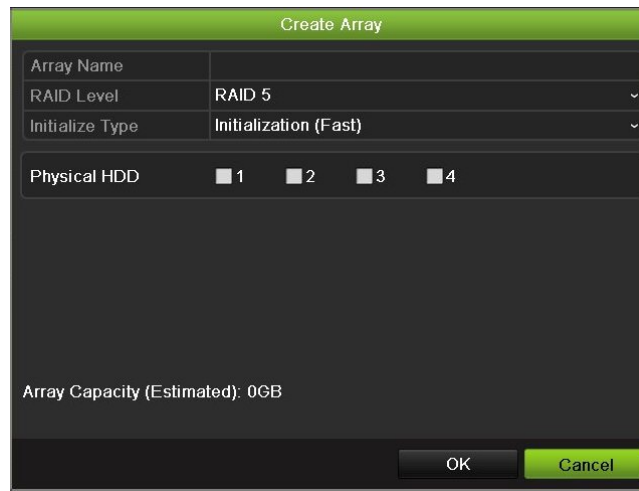

6. Type in a name for the array, select the RAID Level, Initialization Type, and the drives to be included.
7. Click **OK** and then **Initialize** to start the process. When the process is complete, data on the RAID group is displayed.

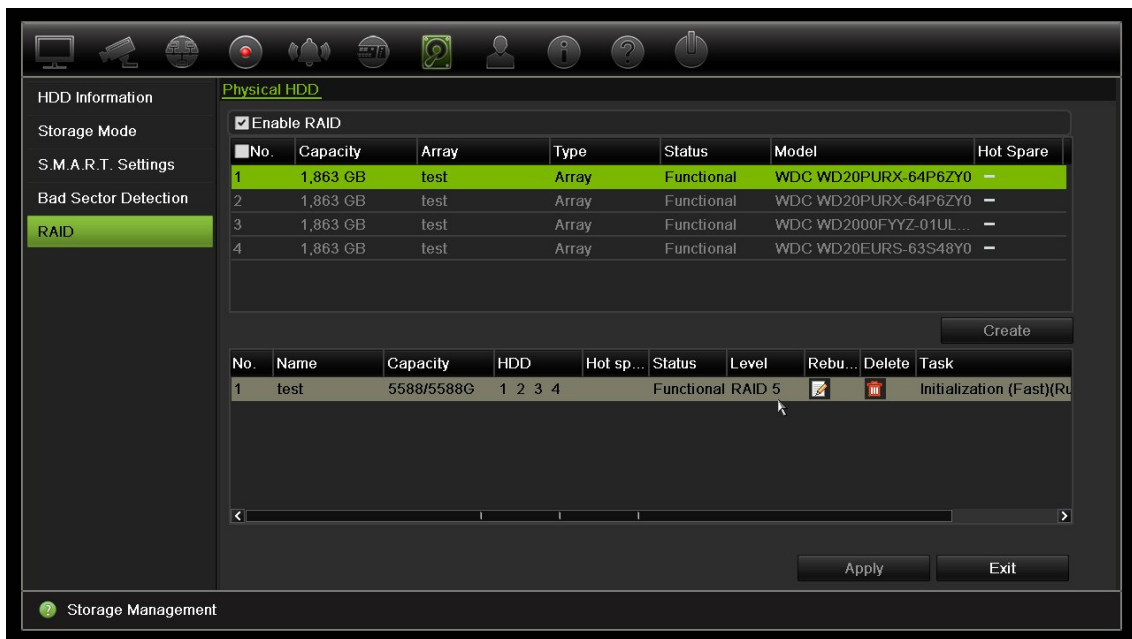

**Note:** You can create a RAID array of RAID 0, RAID 1, RAID 5, and RAID 10.

- If you choose RAID 0, at least 2 HDDs must be installed.
- If you choose RAID 1, 2 HDDs need to be configured for RAID 1.
- If you choose RAID 5, at least 3 HDDs must be installed.
- If you choose RAID 10, 4/6/8 HDDs need to be configured for RAID 10.

### To verify the RAID:

1. Click **Storage Management > HDD Information**.

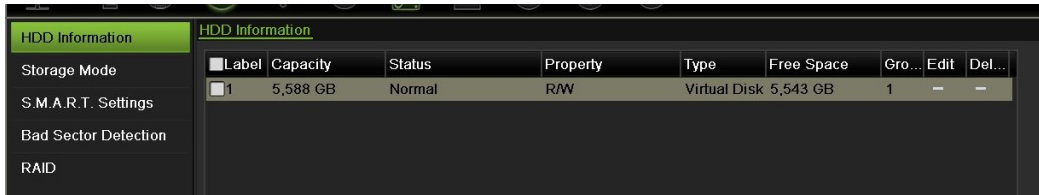

**To rebuild a damaged RAID:**

If a drive in the RAID array fails you can rebuild the array.

1. From the menu toolbar, click **Storage Management > RAID**.

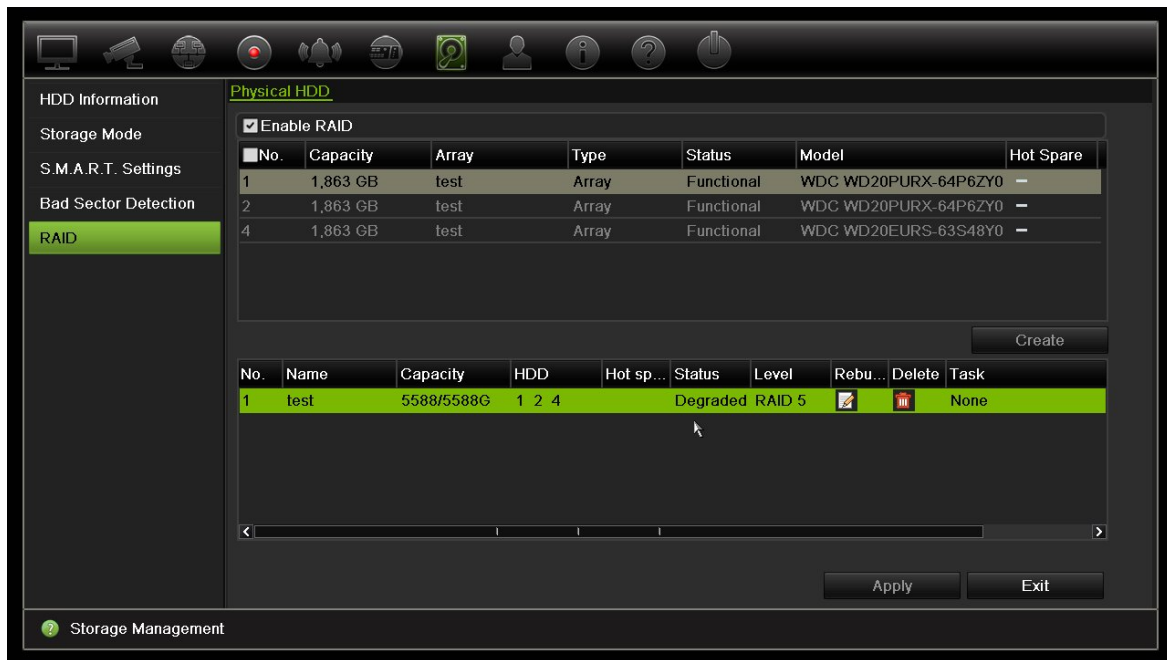

2. Click the **Rebuild** icon  to open the *Rebuild Array* window.
3. Click **OK** to start the rebuilding process
4. When complete the system will reboot.

# Chapter 16

## User management

By default the recorder comes with three user accounts: an Administrator account, an Operator account, and a Guest account. These accounts provide multiple levels of access and functionality. See Table 17 below for a description of the different user accounts.

**Table 17: User accounts**

User	Description
<b>Administrator</b>	<p>The administrator account includes extended menu with full access to all settings. The Administrator has the authority to add, delete, or configure parameters for many of the system functions.</p> <p>There can only be one administrator.</p> <p>The user name is "admin". The name cannot be modified.</p> <p>The default password is 1234.</p>
<b>Operator</b>	<p>The operator account includes reduced menu access to Video settings (inaccessible features are not visible).</p> <p>The default user name is "operator".</p> <p>The default password is 2222.</p>
<b>Guest</b>	<p>The guest account includes menu access with no programming possibilities (inaccessible features are not visible).</p> <p>The default user name is "guest".</p> <p>The default password is 3333.</p>

**Note:** The default passwords should be changed for security reasons.

### Add a new user

Only a system administrator can create a user. You can have a maximum of 32 users (the administrator as well as operators and guests).

### To add new users:

1. From the menu toolbar, click **User Management**.
2. If you require a higher level of password security, check **Enable Complex Password**. Passwords must then have at least eight characters and include characters and numbers, symbols and numbers, characters and symbols, or characters, numbers and symbols.  
**Note:** Default is off.
3. Click **Add** to enter the Add User window.
4. Enter the new user's name and password. Both the user name and password can have up to 16 alphanumeric characters.
5. Select the new user's access level: Operator or Guest. Default is Guest.
6. Enter the user's MAC address to let the user access the recorder from a remote computer with this MAC address. This step is optional.
7. Click **OK** to save the settings and return to the previous window.
8. Define the user's permissions.

Click the **Permission** button  for the new user. In the Permissions pop-up window check the required access privileges for local, remote and camera configuration. See "Customize a user's access privileges" below for the permission descriptions for each group.

Click **Apply** to save the settings and **OK** to return to the previous window.

9. Click **Exit** to return to live view.

## Customize a user's access privileges

Only an administrator can allocate access privileges to Operator and Guest users. The access privileges can be customized for each user's needs. The administrator's access privileges cannot be changed.

There are three types of privilege settings: Local Configuration, Remote Configuration, and Camera Configuration.

**Note:** Only the administrator can restore factory default settings.

### Local configuration settings

By default, only the local information (log) management setting is enabled for both operators and guests.

- **Local Information (Log) Management:** Search and view logs of the recorder and view system information.
- **Local Parameter Settings:** Configure parameters and import the configuration from the recorder.



- **Local Camera Management:** Locally add, delete, and edit IP cameras.
- **Local Advanced Operation:** Access HDD management (including the initialization and modification of disk properties). Update system firmware as well as stop the I/O alarm output.
- **Local Shutdown/Reboot:** Shutdown or reboot the recorder.

## Remote configuration settings

By default, only remote log search and two-way audio are enabled for operators, and only the remote log search is enabled for guests.

- **Remote Log Search:** Remotely view logs that are saved on the recorder.
- **Remote Parameter Settings:** Remotely configure parameters and import configuration.
- **Remote Camera Management:** Remotely enable and disable channels.
- **Remote Serial Port Control:** Remotely configure RS-232 and RS-485 ports.
- **Remote Video Output Control:** For future use.
- **Two-Way Audio:** Use two-way audio between the remote client and the recorder.
- **Remote Alarm Control:** Remotely alert or control the relay output of the recorder. Alarm and notification settings must be configured properly to upload to host.
- **Remote Advanced Operation:** Remotely manage HDDs (initializing and setting properties for HDDs) as well as remotely update system firmware and clear the I/O alarm output.
- **Remote Shutdown/Reboot:** Remotely shutdown or reboot the recorder.

## Camera configuration settings

By default, all IP cameras are enabled for operators for each of these settings. By default, the IP cameras are only enabled for local playback and remote playback for guests.

- **Local Live View:** Locally select and view live video.
- **Local Playback:** Locally play recorded files that are on the recorder.
- **Local Manual Operation:** Locally start/stop manual recording on any of the channels, snapshots, and video clips.
- **Local PTZ Control:** Locally control PTZ dome cameras.
- **Local Video Export:** Locally back up recorded files from any of the channels.
- **Remote Live View:** Remotely select and view live video over the network.
- **Remote Playback:** Remotely play and download recorded files that are on the recorder.

- **Remote Manual Operation:** Remotely start/stop manual recording on any of the channel.
- **Remote PTZ Control:** Remotely control PTZ dome cameras.
- **Remote Video Export:** Remotely backup recorded files from any channel.

#### To customize a user's access privileges:

1. Click the **User Management** icon in the menu toolbar to display its window.
2. Click the Permission button  for the user whose access privileges need to be changed. The Permissions pop-up window appears.
3. Click **Apply** to save the settings.
4. Click the **OK** button to return to the previous window.
5. Click **Exit** to return to live view.

## Delete a user

Only a system administrator can delete a user.

#### To delete a user from the recorder:

1. Click the **User Management** icon in the menu toolbar to display its window.
2. Click the **Delete** button  for the user to be deleted.
3. Click **Yes** in the pop-up window to confirm deletion. The user is immediately deleted.
4. Click **Exit** to return to live view.

## Modify a user

A user's name, password, access level, and MAC address can be changed. Only a system administrator can modify a user.

#### To modify a user:

1. Click the **User Management** icon in the menu toolbar to display its window.
2. Click the Edit button  for the user whose details need to be changed. The Edit User pop-up window appears.
3. Edit the user information and click **OK** to save the settings and return to the previous window.
4. Click **Exit** to return to live view.

## Change the Admin password

The administrator's password can be changed in the **User Management** menu.

### To change the admin password:

1. Click the **User Management** icon in the menu toolbar to display its window.
2. Click the Edit button  for admin. The Edit User pop-up window appears.
3. Edit the current admin password and check the **Change Password** box.
4. Enter the new admin password and confirm it. Change the admin MAC address, if required. Click **OK** to save the settings and return to the previous window.
5. Click **Exit** to return to live view.

# Chapter 17

## System information

### View system information

To view system information:

1. From the menu toolbar, click **System Information**.
2. To view device information, click **Device Info**.

You can view the device name, model, serial number, firmware version, and encoding version. The QR code for the recorder is also displayed.

You can quickly enter the recorder parameters into TVRMobile by scanning the QR code.

**Note:** The TVRMobile app must first be installed on your smart phone before scanning the recorder QR code.

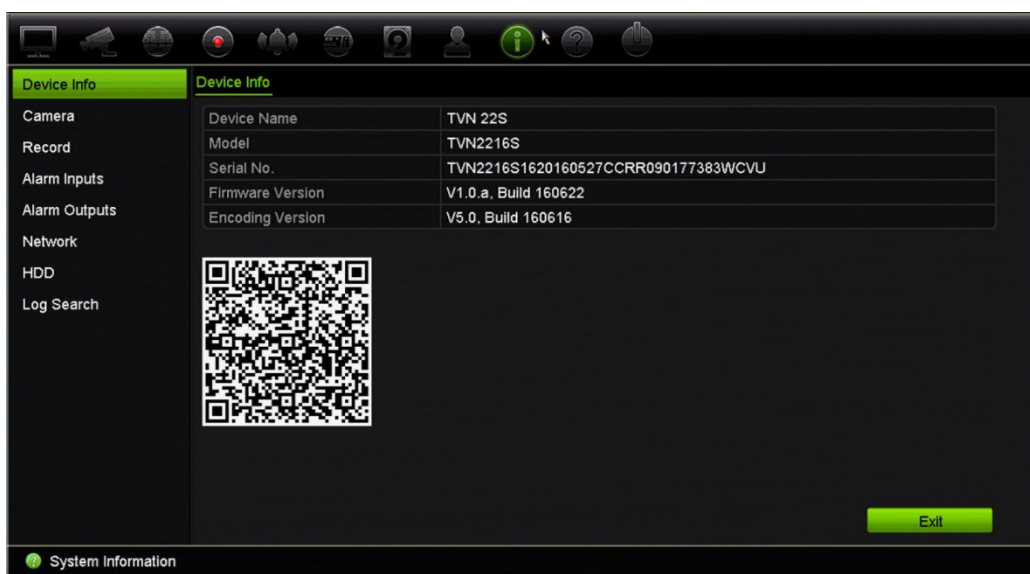

3. To view camera information, click **Camera**.

You can view the information on each camera: Camera number, camera name, status, motion detection, tamper proof, video loss, preview link sum, and preview link information.

Preview link sum shows the amount of rote applications that are streaming video from this video channel. Preview link information shows you the IP addresses that are currently connected to this channel.

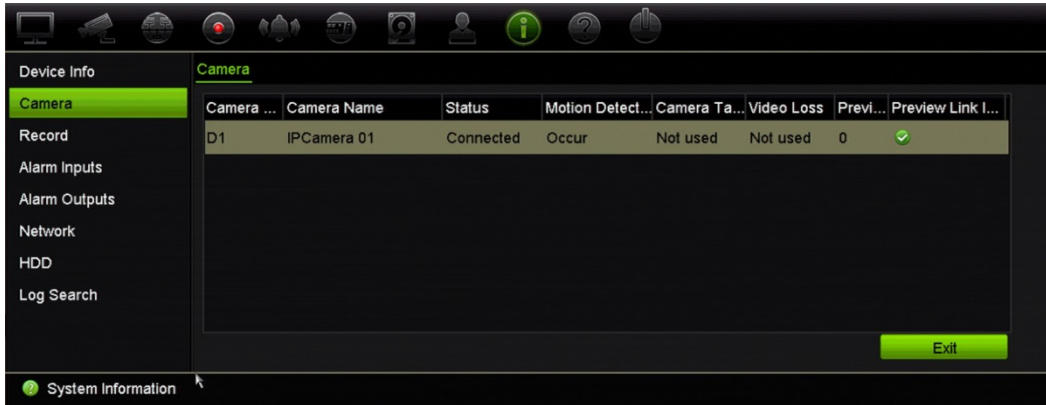

4. To view record information, click **Record**.

You can view the camera number, recording status, stream type, active frame rate, active bit rate versus reserved bit rate (Kbps), active resolution, active record type, and active encoding parameters.

The “Preview Link Sum” shows the number of streams being viewed by the recorder. The “Preview Link Information” lists all the IP addresses of the streams viewed by the recorder.

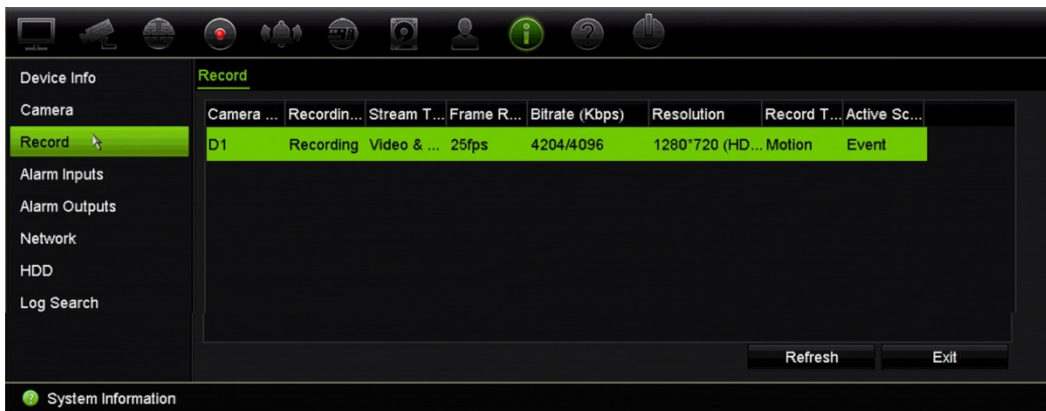

5. To view alarm input information, click **Alarm Inputs**.

You can view the alarm input number, alarm name, alarm type, alarm status, and triggered camera.

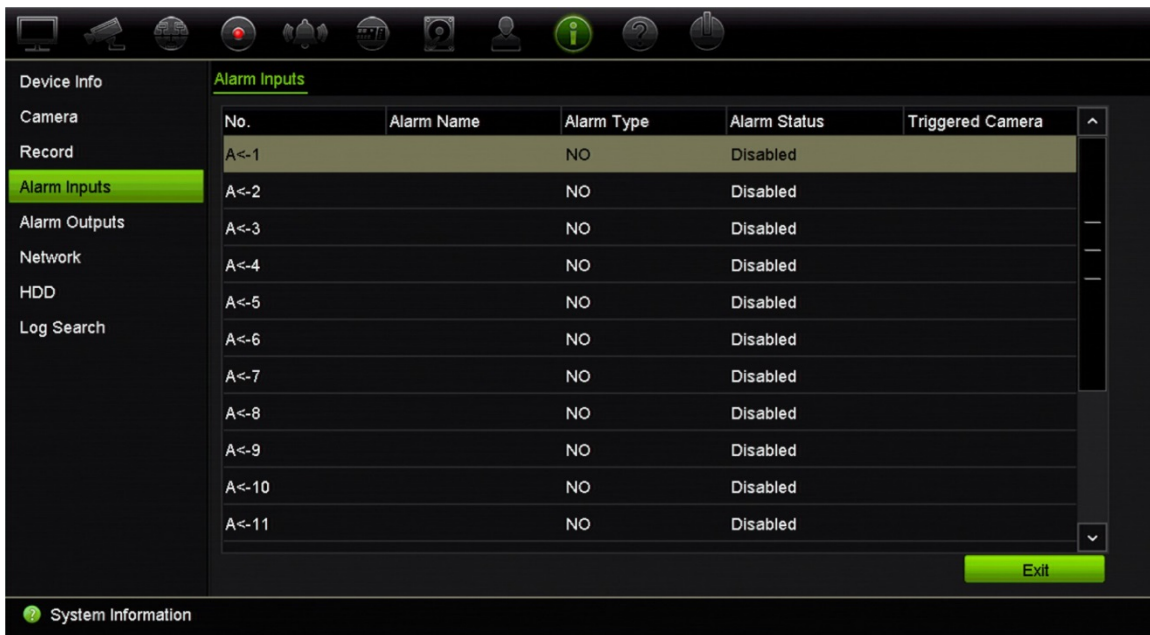

6. To view alarm output information, click **Alarm Outputs**.

You can view the alarm output number, alarm name, and alarm status.

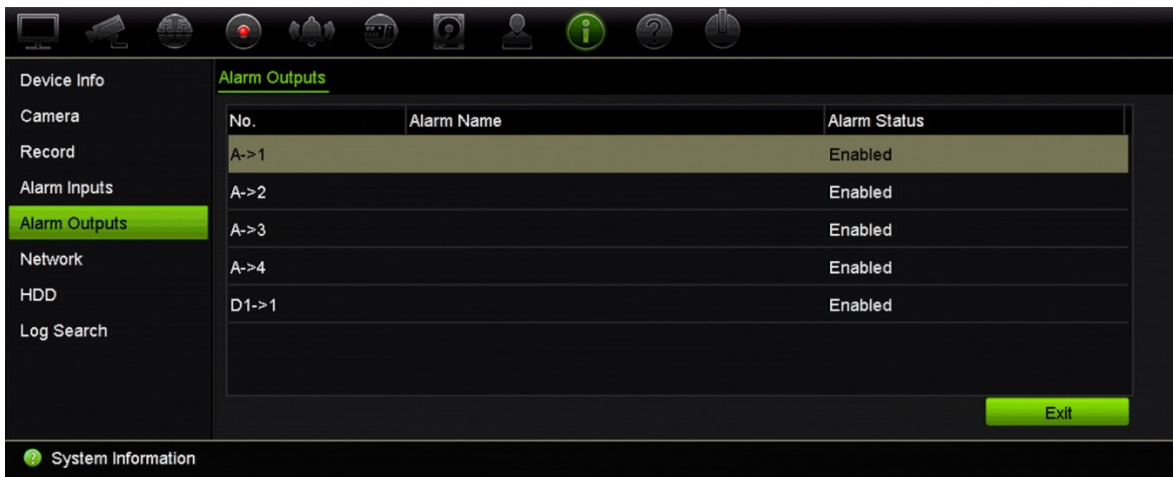

7. To view network information, click **Network**.

You can view the NIC, IPv4 address, IPv4 subnet mask, IPv4 default gateway, IPv6 address 1, IPv6 address 2, IPv6 default gateway, preferred DNS server, alternate DNS server, enable DHCP, enable PPPoE, PPPoE address, PPPoE subnet mask, PPPoE default gateway, server port, HTTP port, multicast IP, RTSP service port, and outgoing bandwidth limit (Kbps).

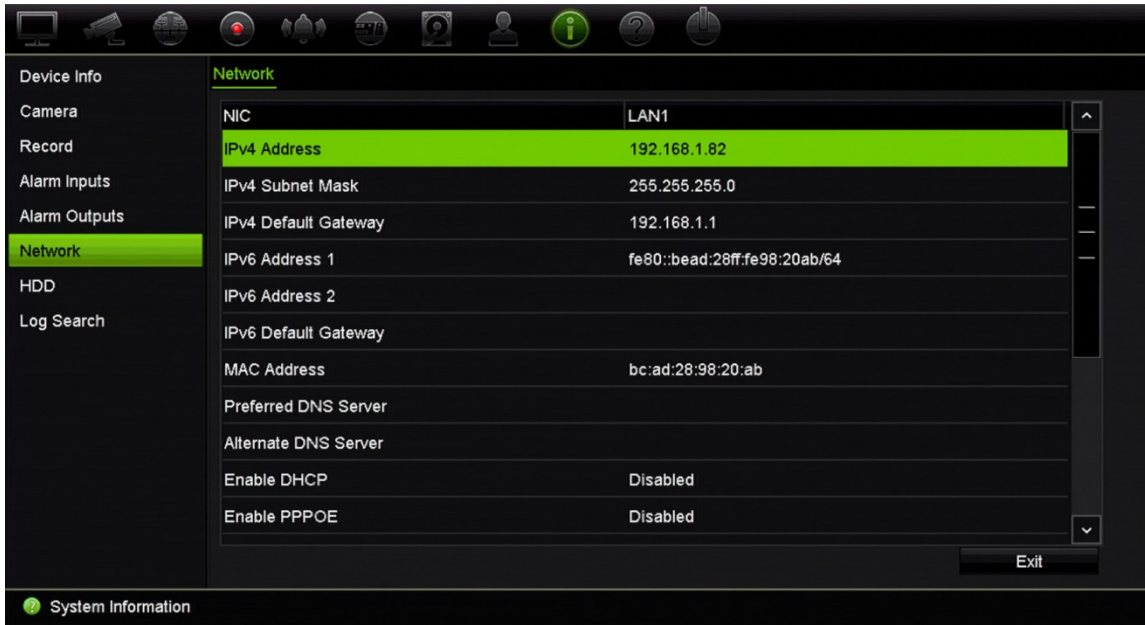

8. To view HDD information, click **HDD**.

You can view the HDD label, status, capacity, free space, property, type, and group.



9. Click **Exit** to return to live view.

## Search the system log

Many events of the recorder, such as operation, alarm, and notification, are logged into the system logs. They can be viewed and exported at any time.

Up to 2000 log files can be viewed at once.

Log files can also be exported onto a USB device. The exported file is named according to the time it was exported. For example: 20140729124841logBack.txt.

**Note:** Connect the backup device, such as a USB flash drive, to the recorder before commencing the log search.

**To search video from the system log:**

1. From the menu toolbar, click **System Information > Log Search**.
2. Select the search start and end date and times.
3. Under **Event**, select an option from the drop-down list: All, Alarm, Notification, Operation, or Information.
4. From the **Type** list, select one of the options:

Event	Type
All	All
Alarm	All, Alarm Input, Alarm Output, Start Motion Detection, Stop Motion Detection, Start Camera Tamper, Stop Camera Tamper, Cross Line Alarm Stopped, Cross Line Stopped, Perimeter Intrusion Alarm Started
Notification	All, Video Loss Alarm, Illegal Login, HDD Full, HDD Error, Duplicate IP Address Found, Network Disconnected, Abnormal Record, IP Camera Disconnected, IP Camera Address Conflicted, IP Camera Access Exception, Record Buffer Overflow, Hot Spare Exception, IP Camera Motion Analysis Exception, PoE Power Overload
Operation	All, Power Up, Local: Shutdown, Abnormal Shutdown, Watchdog Reboot, Local: Restart, Local: Login, Local: Logout, Local: Configure Parameters, Local: Upgrade, Local: Operation: Restore Defaults, Local: Factory Defaults, Local: Start Manual Recording, Local: Stop Manual Recording, Local: PTZ Control, Local: Lock File, Local: Unlock File, Local: Trigger Alarm Output, Local: Initialize HDD, Local: Add IP Camera, Local: Delete IP Camera, Local: Set IP Camera, Local: Upgrade IP Camera Firmware, Local: Import IP Camera File, Local: Export IP Camera File, Local: Playback by File, Local: Playback by Time, Local: Playback by Snapshot file, Local: Export Config File, Local: Import Config File, Local: Export Record File, Local: Snapshot File, Local: Add Network Storage, Local: Delete Network Storage, Local: Set Network Storage, Local: Restore Admin's Password, Local: Operate Bookmark, Local: Import Audio File, Local: Delete Audio File, Local: Switch Output, Local: HDD Detect, Local: Unload HDD, Local: Load HDD, Local: Delete HDD, Local: Configure SNMP, Local: Add/Delete Working Device, Local: Operation: Export Heat Map File, Local: Operation: Export People Counting File, Quick Snapshot, Playback Snapshot, Remote: Shutdown, Remote: Reboot, Remote: Login, Remote: Logout, Remote: Configure Parameters, Remote: Upgrade, Remote: Operation: Restore Defaults, Remote: Operation: Factory Defaults, Remote: Start Manual Recording, Remote: Stop Manual Recording, Remote: PTZ Control, Remote: Lock File, Remote: Unlock File, Remote: Trigger Alarm Output, Remote: Initialize HDD, Remote: Add IP Camera, Remote: Delete IP Camera, Remote: Set IP Camera, Remote: Upgrade IP Camera Firmware, Remote: Import IP Camera File, Remote: Export IP Camera File, Remote: Playback by File, Remote: Playback by Time, Remote: Download by File, Remote: Download by Time, Remote: Export Config File, Remote: Import Config File, Remote: Export Record File, Remote: Export Snapshot File, Remote: Get Parameters, Remote: Get Working Status, Connect Transparent Channel, Disconnect Transparent Channel, Start Two-way Audio, Stop Two-way Audio, Remote: Alarm Arming, Remote: Alarm Disarming, Remote: Add Network Storage, Remote: Delete Network Storage, Remote: Set Network Storage, Remote: Operate Bookmark, Remote: Delete HDD, Remote: Remote: Load HDD, Remote: Unload HDD, Remote: Configure SNMP, Remote:



Add/Delete Working Device Restore Device Parameters	
Information	All, Local HDD Information, HDD S.M.A.R.T., Start Recording, Stop Recording, Delete Expired Record, Network Storage Information, System Running Status, Spare Start Backup, Spare Stop Backup, Spare Word Device Information, EFR Record Started, EFR Record Stopped, ADD IP Camera EFR Time Duration, Delete IP Camera EFR Time Duration

5. Click the **Search** button. A list of results appears.

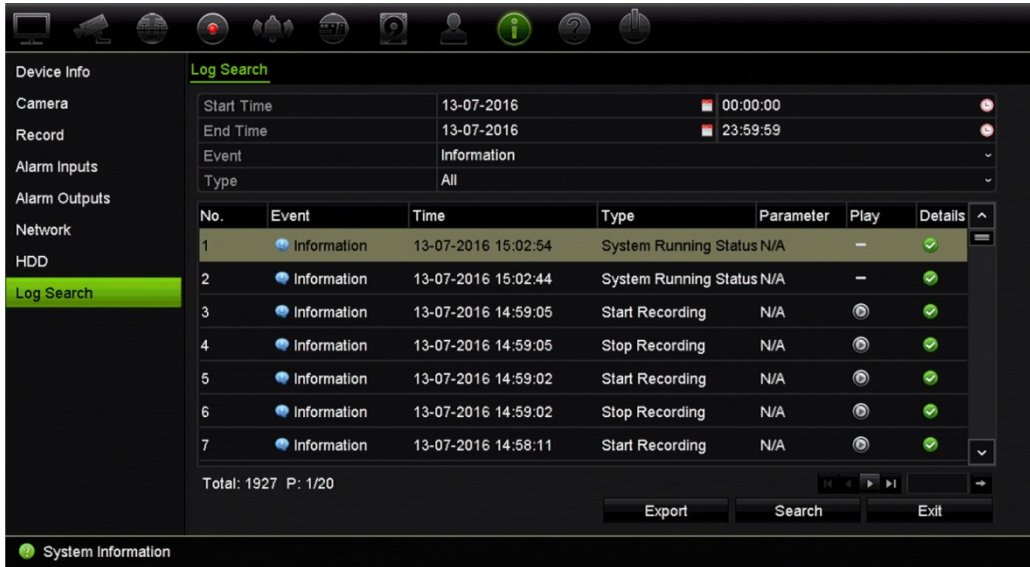

6. Select a file and click:

- **Details:** Displays information on the log or recording. For a recording, it lists such information as start time, type of event, local user, host IP address, parameter type, camera number, and gives a description on the types of events recorded and when record time was stopped.

- **Play:** Click to start playback of the selected recording.

- **Export:** Click to archive the selected file to a USB device. The Export window appears.

7. Click **Exit** to return to live view.

# Chapter 18

## Using the web browser

This chapter describes how you can use the web browser interface to configure the device, play back recorded video, search through event logs, and control a PTZ dome camera. You can also specify settings on the web browser interface to optimize video playback and recording performance when operating in a low or limited bandwidth environment. Many of the browser configurations are similar to those done locally.

### Internet Explorer users

Internet Explorer for Windows operating systems have increased security measures to protect your PC from any malicious software being installed. When using the recorder web browser interface, you can install ActiveX controls to connect and view video using Internet Explorer.

To have complete functionality of the web browser interface and the recorder player with Internet Explorer, do the following:

- Run the Browser interface and the recorder player application as an administrator in your workstation
- Add the recorder's IP address to your browser's list of trusted sites

#### **To add the recorder's IP address to Internet Explorer's list of trusted sites:**

1. Open Internet Explorer.
2. Click **Tools**, and then **Internet Options**.
3. Click the Security tab, and then select the Trusted Sites icon.
4. Click **Sites**.
5. Clear the "Require server verification (https:) for all sites in this zone" box.
6. Enter the IP address or DDNS name in the "Add this website to the zone" field.
7. Click **Add**, and then click **Close**.
8. Click **OK** in the Internet Options dialog box.
9. Connect to the recorder for full browser functionality.

## Access the web browser

To access the recorder, open the Microsoft Internet Explorer web browser, and enter the IP address assigned to the recorder, as a web address. On the logon window, enter the default user ID and password.

**Note:** Only one recorder can be viewed per browser.

User ID: admin

Password: 1234

The default values for recorder network settings are:

- IP address - 192.168.1.82
- Subnet mask - 255.255.255.0
- Gateway address - 192.168.1.1
- Server port: 8000
- Ports:

When using the browser:

RTSP port: 554

HTTP port: 80

When using TruNav:

RTSP port: 554

Server/Client software port: 8000

For more information on port forwarding, see Appendix B “Port forwarding information” on page 149.

## HTTPS settings

Using HTTPS (Hypertext Transfer Protocol Secure) is a secure protocol that provides authenticated and encrypted communication. It ensures that there is a secure private channel between the recorder and cameras

You can create self-signed server certificates as well as request certified server certificates to ensure your network security.

Figure 32: HTTPS configuration screen

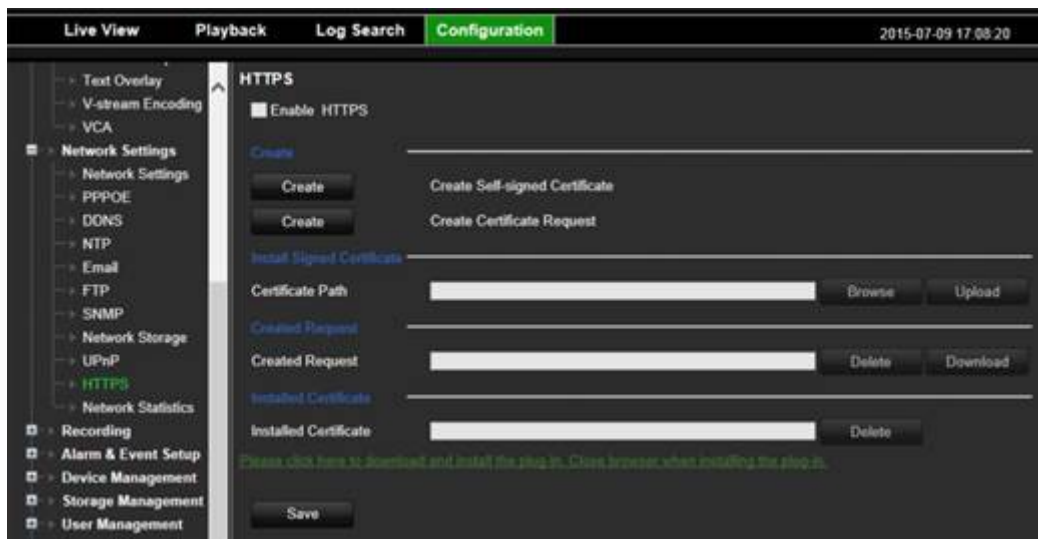

### Create a certificate:

1. Go to the **Configuration > Network Settings > HTTPS** section of the browser.
2. Click “**Create Self-Signed certificate**”.
3. Type in country, hostname/IP address, and days of validity (there are more parameters, but you don't need to add anything to them).
4. Click **OK**.
5. Check “**Enable HTTPS**”.

This only works if you enter the address in the browser as HTTPS (as in <https://192.168.1.70>).

6. Click through the warning you get on the browser.

### Buy a certificate:

1. Go to the **Configuration > Network Settings > HTTPS** section of the browser.
2. Click “**Create Certificate Request**” and fill out the parameters that appear.
3. Click **OK**.
4. Click “**Download**” next to the request that you just created in the browser, and get a .csr file.
5. Visit a site like <https://www.startssl.com/?app=1> and upload your .csr file to get a trusted certificate.

For larger companies, a corporate certificate might be available with the IT department.

## Mac Safari Browser users

For TruVision recorder browser functionality in Mac Safari browsers, a plug-in must be installed.

### System requirements

- Mac OS > 10.7
- Safari > 8.0.5

### Supported recorders

- TVR 12HD v1.0.i
- TVR 44HD v1.0.c
- TVR 42 v1.2.d
- TVR 12 v1.2.c
- TVN 10 v2.0.f
- TVN 21 v3.0.f
- TVN 22 v1.0
- TVN 70 v1.2f

## Plug-in installation

1. Download the TruVision Mac Safari Browser Plug-In v1.0 file from the Interlogix web page. Navigate from the home page by clicking **Video**, then **Recorders**. Select your recorder and click the **Downloads** link. Scroll down to **Software**. Click on the download link.
2. Unzip the *UTCWebVideoPlugin.zip* file and extract the pkg file to your desktop.



3. Open the file by clicking **Open**.
4. Follow the installation instructions.

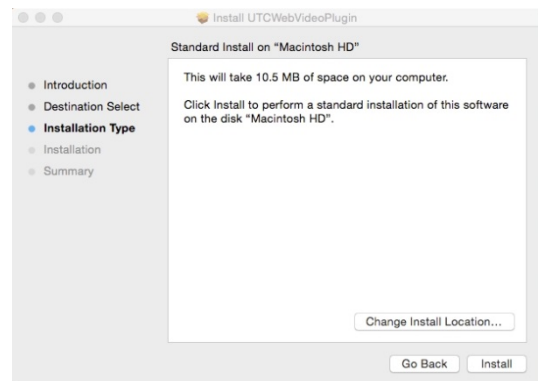
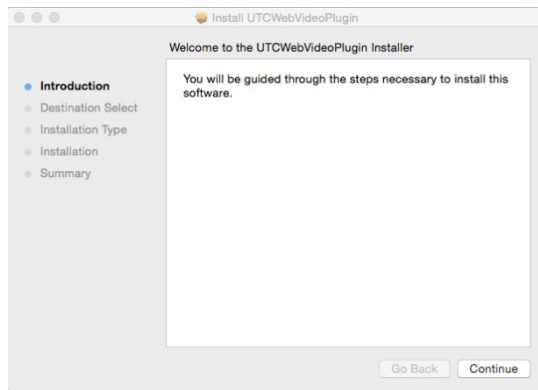

5. Enter the computer's Username and Password when requested.

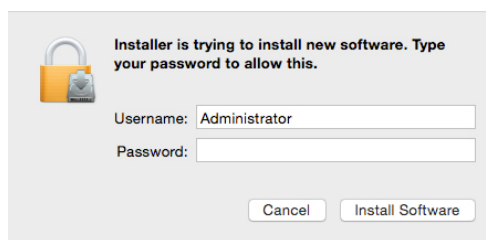

6. After a successful installation, close the installation dialog window.

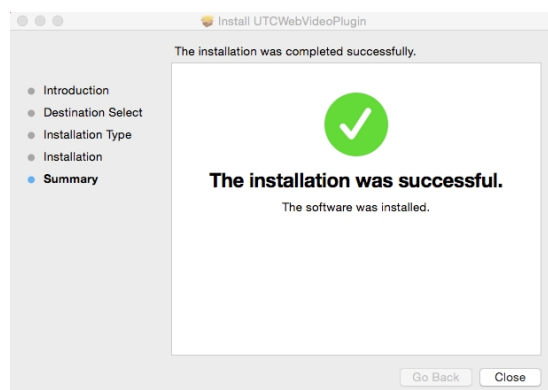

7. Open Safari and connect to any supported device.

## Known limitations

- Only the Safari browser is supported (not Chrome).
- Does not support bi-directional audio.
- Does not support text in.
- Does not support the display of intelligent information of VCA events on the live view page.

## Web browser live view











The recorder web browser lets you view, record, and play back videos as well as manage all aspects of the recorder from any PC with Internet access. The browser's easy-to-use controls give you live view all the recorder functions. See Figure 33 below.

Figure 33: Live view in the web browser interface



Table 18: Description of live view in the web browser

Name	Description
1. Camera	Select the camera.
2. Menu toolbar	Lets you do the following: <ul style="list-style-type: none"> <li>• View live video</li> <li>• Play back video</li> <li>• Search for event logs</li> </ul>

Name	Description
	<ul style="list-style-type: none"> <li>• Configure settings</li> <li>• Log out of the interface</li> </ul>
3. Viewer	View live or playback video.
4. Display format	Define how you want video to be displayed in the viewer: Multiview or full-screen.
5. Video function toolbar	<p>Let's you do the following in live view:</p> <ul style="list-style-type: none"> <li> Switch between mainstream and substream.</li> <li> Start/stop all streaming from selected cameras.</li> <li> Start recording from selected cameras.</li> <li> Digital zoom.</li> <li> Take a video snapshot.</li> <li> View previous and next camera respectively.</li> <li> If viewing in multiview format, live view moves to the next group of cameras for the selected number of video tiles.</li> <li> Turn audio on/off</li> <li> Turn microphone on/off</li> </ul>
6. Alarm Trigger Output	 Turn Alarm Output on/off
7. PTZ panel	Hide/display the PTZ panel.



# Control a PTZ dome camera via the web browser

The web browser interface lets you control the PTZ functions of a dome camera. Click a PTZ dome camera and use the PTZ controls on the interface to control the PTZ functions.

**Figure 34: PTZ controls**

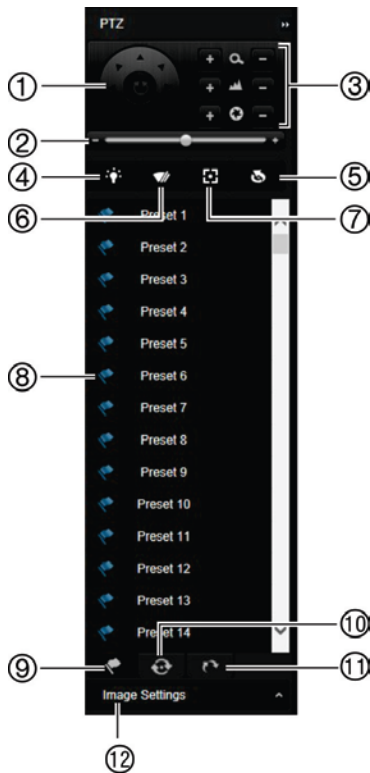

1. Directional pad/auto-scan buttons: Controls the movements and directions of the PTZ. Center button is used to start auto-pan by the PTZ dome camera.
2. Adjust speed of PTZ dome camera.
3. Adjust zoom, focus, and iris.
4. Turn on or off the camera light (if available on the camera).
5. Lens initialization: Initialize the lens of a camera with a motorized lens, such as PTZ or IP cameras. This function helps to maintain lens focus accuracy over prolonged periods of time.
6. Start or stop camera wiper (if available on the camera).
7. Auxiliary focus: Automatically focus the camera lens for the sharpest picture.
8. Start selected preset/tour/shadow tour (depending on function selected).
9. List the presets available.
10. List the preset tours available.
11. List the shadow tours available.
12. Modify brightness, contrast, saturation, and hue values.





# Play back recorded video









To search and play back recorded video, click **Playback** in the menu bar to display the Playback page shown in Figure 35 below.

Figure 35: Browser playback page



## Description

1. Selected camera.
2. **Multiview:** Select the desired multiview format.
3. **Calendar:** Selected day is highlighted.
4. **Search:** Click to start searching recorded files for the selected camera.
5. **Player Download:** Click to download the Player application required to play back recordings.
6. **Timeline:** The timeline moves from left (oldest video) to right (newest video). Click a location on the timeline to move the cursor to where you want playback to start.
7. **Playback control toolbar:**
  -  **Reverse:** Click to reverse playback.
  -  **Play/pause:** Play or pause playback.
  -  **Stop playback.** Playback is stopped and the window changes to black.
  -  **Playback reverse:** Click to scroll through the different speeds available: 1/8 speed, 1/4 speed, 1/2 speed, normal, X2 speed, X4 speed, and X8 speed. Current speed is displayed under the camera name on the top right of the window.
  -  **Playback forward:** Click to scroll through the different speeds available: 1/8 speed, 1/4 speed, 1/2 speed, normal, X2 speed, X4 speed, and X8 speed. Current speed is displayed under the camera name on top right of window.

	Description
	 <b>Single frame:</b> Click to play back one frame at a time.
8.	 <b>Stop all playback:</b> Click to stop all cameras in playback.
9.	<b>Audio and video control toolbar:</b>
	 <b>Digital Zoom:</b> Access digital zoom.
	 <b>Capture:</b> Capture a snapshot of the video.
	 <b>Start/stop Clipping:</b> Start/stop video clip during playback. Sections of a recording are saved to a local computer folder.
	 <b>Download:</b> Download video clips.
	 <b>Backup:</b> Click to make back up of recorded files to save locally on the NVR. A list of the recorded files appears.
	 <b>Audio On/Off:</b> Click to enable/disable audio.
	 <b>Bookmark Management:</b> Manage bookmarks.
10.	<b>Recording type:</b> Description of the color coding of recording types that appear in the playback progress bar. Green indicates continuous recording. Red indicates alarm event recording. Yellow indicates motion recording. Pale green indicates manual recording.
11.	<b>Digital Zoom:</b> Zoom in and out of the selected camera image.
12.	<b>Jump start:</b> Enter a precise time in the box and click the <b>Go To</b> button to jump start the playback from this selected time.
13.	<b>Transcode Panel:</b> This feature allows you to reduce the quality of the stream during playback, which is useful when there is limited bandwidth available. Click the checkbox to enable the feature and select the desired resolution, bitrate and frame rate options.

Select a camera and a day to search from on the calendar displayed, and then click Search. The timeline below the page indicates video recorded for the specified day. The timeline also classifies by color the type of recording with each type.

Click and drag the marker across the timeline on where you want video playback to begin, and then click Play on the playback control toolbar. You can capture a snapshot of a video image, save the video playback, or download the recorded video.

## Search for event logs

The recorder compiles a log of events, such as the start or end of video recording, recorder notifications, and alarms, through which you can easily search. Logs are categorized by the following types:

- **Alarm:** Includes motion detection, tamper detection, video tampering, and other alarm events
- **Notifications:** Includes system notifications such as video loss, HDD failures, and other system-related events
- **Operations:** Includes users access to the web interfaces and other operational events

- **Information:** Includes general information on the recorder actions, such as the start and end of video recording, etc.

To search for logs, click Log on the menu bar, select a log type, specify a date and time range, and then click Search. See Figure 36 below for an example of the results of a log search. For further information on searching and viewing logs, go to “Search the system log” on page 129.

Figure 36: Results of a log search

No.	Log Time	Event	Type	Camera/Alarm/HDD No.	Local/Remote User	Remote Host IP
1	2014-11-14 14:54:50	Operation	Remote Logout		admin	192.168.222.101
2	2014-11-14 14:54:50	Operation	Remote Get Parameters		admin	192.168.222.101
3	2014-11-14 14:54:50	Operation	Remote Login		admin	192.168.222.101
4	2014-11-14 14:54:20	Operation	Remote Logout		admin	192.168.222.101
5	2014-11-14 14:54:20	Operation	Remote Get Parameters		admin	192.168.222.101
6	2014-11-14 14:54:20	Operation	Remote Login		admin	192.168.222.101
7	2014-11-14 14:48:45	Information	System Running State			0.0.0.0
8	2014-11-14 14:48:25	Information	System Running State			0.0.0.0
9	2014-11-14 14:48:59	Operation	Remote Get Parameters		admin	192.168.222.114
10	2014-11-14 14:48:58	Operation	Remote Get Parameters		admin	192.168.222.114
11	2014-11-14 14:48:20	Operation	Remote Logout		admin	192.168.222.101
12	2014-11-14 14:48:20	Operation	Remote Get Parameters		admin	192.168.222.101
13	2014-11-14 14:48:20	Operation	Remote Login		admin	192.168.222.101
14	2014-11-14 14:28:25	Information	System Running State			0.0.0.0
15	2014-11-14 14:28:25	Information	System Running State			0.0.0.0
16	2014-11-14 14:27:21	Information	HDD S.M.A.R.T.	2		0.0.0.0
17	2014-11-14 14:08:24	Information	System Running State			0.0.0.0
18	2014-11-14 14:08:14	Information	System Running State			0.0.0.0
19	2014-11-14 13:48:15	Information	System Running State			0.0.0.0
20	2014-11-14 13:48:05	Information	System Running State			0.0.0.0
21	2014-11-14 13:27:54	Information	System Running State			0.0.0.0
22	2014-11-14 13:27:54	Information	System Running State			0.0.0.0
23	2014-11-14 13:27:17	Information	HDD S.M.A.R.T.	2		0.0.0.0
24	2014-11-14 13:07:54	Information	System Running State			0.0.0.0
25	2014-11-14 13:07:44	Information	System Running State			0.0.0.0
26	2014-11-14 13:02:41	Operation	Remote Logout		admin	192.168.222.102
27	2014-11-14 13:02:41	Operation	Remote Get Parameters		admin	192.168.222.102
28	2014-11-14 13:02:41	Operation	Remote Login		admin	192.168.222.102
29	2014-11-14 12:47:45	Information	System Running State			0.0.0.0
30	2014-11-14 12:47:35	Information	System Running State			0.0.0.0
31	2014-11-14 12:27:34	Information	System Running State			0.0.0.0
32	2014-11-14 12:27:24	Information	System Running State			0.0.0.0
33	2014-11-14 12:27:15	Information	HDD S.M.A.R.T.	2		0.0.0.0
34	2014-11-14 12:07:24	Information	System Running State			0.0.0.0
35	2014-11-14 12:07:14	Information	System Running State			0.0.0.0
36	2014-11-14 11:47:14	Information	System Running State			0.0.0.0
37	2014-11-14 11:47:54	Information	System Running State			0.0.0.0
38	2014-11-14 11:28:01	Operation	Remote Playback by Time	A9	admin	192.168.222.104
39	2014-11-14 11:27:13	Information	HDD S.M.A.R.T.	2		0.0.0.0

## Recording from the browser

Videos and snapshots that are recorded via the browser are saved on your computer and not on the recorder.

Select a camera and a day to search from on the calendar displayed, and then click Search. The timeline below the page indicates video recorded for the specified day. The timeline also classifies by color the type of recording.

Click and drag the marker across the timeline on where you want video playback to begin, and then click Play on the playback control toolbar. You can capture a snapshot of a video image, save the video clips, or download the recorded video.

## Configure the recorder via the browser

Click **Configuration** on the menu toolbar to display the configuration window. There are two major parts to the browser based configuration: Local and Remote.

## Local configuration

Local configuration includes all settings related to the web browser application such as where to store snapshots and video exports.

## Remote configuration

Remote configuration includes settings related to the recorder itself. Many of the settings covered in remote configuration are also available in the local on screen display.

Figure 37: Remote browser configuration window (System Information window shown)

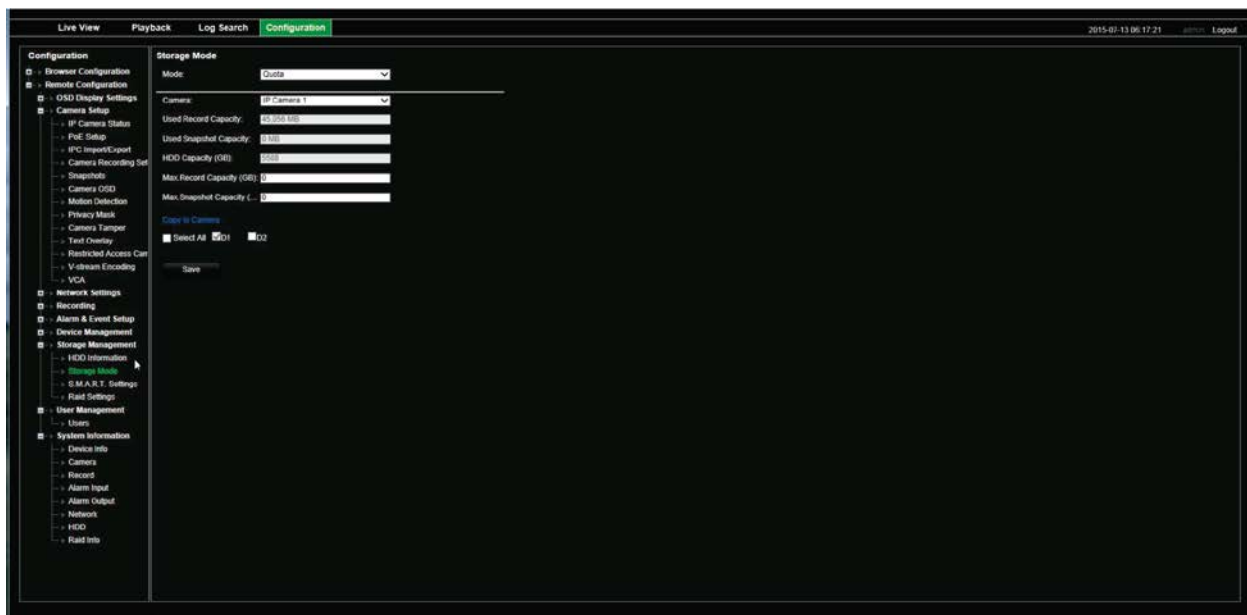

Table 19: Description of remote configuration menus

Menu	Function	Description
Camera Setup	Camera Recording Settings	Define the general camera settings such as camera name, stream record mode, resolution, frame rate, audio recording, and pre and post event times.
	Snapshots	Define the image quality of snapshots. See “Snapshots” on page 61 for further information.
	Camera OSD	Define which information is displayed on-screen. See “Camera OSD” on page 62 for further information.
	Motion Detection	Define motion detection parameters. See “Motion detection” on page 64 for more information.
	Privacy Mask	Define the on-screen privacy mask areas. See “Privacy mask” on page 65 for more information.
	Camera Tamper	Define the video tampering detection settings. See “Camera tamper” on page 66 for more information.
	VCA	You can define an area on screen to enable a VCA alarm.
	PTZ Preset/Tours	Define and select PTZ Presets and Tours.SD

Menu	Function	Description
Network Settings	Network Settings	Define the general network settings. See “Network settings” on page 74 for more information.
	PPPoE	Define the PPPoE settings. See “PPPoE settings” on page 76 for more information.
	DDNS	Define the DDNS settings. See “DDNS settings” on page 77 for more information.
	NTP	Define the NTP server settings. See “NTP server settings” on page 78 for more information.
	Email	Define the settings to send an e-mail. See “Email settings” on page 79 for more information.
	FTP	Define the FTP settings. See “Configure an FTP server to store snapshots” on page 80 for more information.
	SNMP	Define the SNMP settings. See “SNMP settings” on page 80 for more information.
	UPnP	Enable this function so that the recorder can automatically configure its own port forwarding. See “UPnP settings” on page 81 for more information.
	More Settings	Define a multicast IP as well as the server, HTTP, and RTSP ports. See page 74.
	Net Statistics	Check the bandwidth being used by remote live view and playback. See “Network statistics” on page 83 for more information.
Recording	Recording Schedule	Define the recording schedules. See “Recording schedule” on page 84 for more information.
	Manual Recording	Define which cameras can manually record. See “Manual recording” on page 87 for more information.
Alarm & Event Setup	Alarm Input	Define the alarm input parameters for when an external alarm is triggered. See “Set up alarm inputs” on page 91 for more information.
	Alarm Output	Define the response when an external alarm is triggered. See “Manual trigger” on page 94 for more information.
	Manual Trigger	Define the manually trigger outputs of the recorder. See “Manual trigger” on page 94 for further information.
	Notifications	Define the notification parameters when irregular events occur, such as a HDD is full. See “Event notifications” on page 95 for more information.
	Video Loss	Define the video loss detection settings. See “Detect video loss” on page 97 for more information.
	Alarm Host Setup	Define the remote alarm host. See “Alarm host setup” on page 98 for more information.
	Intrusion Zone Setup	Define the alarm panel in the recorder. See “OH alarm reporting” on page 99 for more information.
	Intrusion Panel Setup	Define the zones in an alarm panel. See “OH alarm reporting” on page 99 for more information.

Menu	Function	Description
Device Management	Time & Date Setting	Define time and date. See “Time and date” on page 105 for more information.
	General Settings	Define the general settings of the recorder such as language, device name, enable the wizard, menu timeout, and enable front panel lock. See “General recorder settings” on page 107 for more information.
	Configuration Files	Import/export configuration settings, restore default factory settings, and restart the recorder. See “Configuration files” on page 108 for more information.
	Upgrade Firmware	Upgrade the recorder firmware. See “Upgrade system firmware” on page 109 for more information.
	Holiday	Define how recordings occur during holiday periods. See “Holiday schedules” on page 109 for more information.
Storage Management	HDD Information	Define the HDD basic settings and initialize the HDD. See “HDD information” on page 112 and “Initialize a HDD” on page 113 for more information.
	Storage Mode	Define the storage mode of the HDD. See “Storage mode” on page 114 and “Group HDDs” on page 115 for more information.
	S.M.A.R.T. Settings	List the S.M.A.R.T. information on the HDD. See “S.M.A.R.T. settings” on page 116 for more information.
User Management	Users	Define, modify, and delete users. See Chapter 17 “System information” on page 126 for more information.
System Information	Device Info	Review the status of the device. See Chapter 17 “information” on page 126 for more information.
	Camera	Review the status of the cameras. See Chapter 17 “System information” on page 126 for more information.
	Record	Review the status of the recordings. See Chapter 17 “System information” on page 126 for more information.
	Alarm Input	Review the status of the alarm inputs. See Chapter 17 “System information” on page 126 for more information.
	Alarm Output	Review the status of the alarm outputs. See Chapter 17 “System information” on page 126 for more information.
	Network	Review the status of the network. See Chapter 17 “System information” on page 126 for more information.

# Appendix A

## Specifications

	TVN 2208(S)	TVN 2216(S)	TVN 2232
<b>Video &amp; audio input</b>			
Video compression	H.265/H.264/MPEG		
Audio compression	G722, G711		
IP video input	8-ch	16-ch	32-ch
Audio input	1-ch, RCA (2.0 Vp-p, 1 kΩ)		
Bi- directional audio	Using the audio input		
Total bandwidth available	80 Mbps/256 Mbps	160 Mbps/256 Mbps	256 Mbps/256 Mbps
<b>Video &amp; audio output</b>			
HDMI output	1-ch, Resolution: 3840 × 2160/60Hz, 3840 × 2160/30Hz, 1920 × 1080/60Hz , 1600×1200/60Hz , 1280×1024/60Hz 1280×720/60Hz , 1024×768/60Hz		
VGA output	1-ch, Resolution: 1920 × 1080P / 60 Hz, 1280 × 1024 / 60 Hz, 1280 × 720 / 60 Hz, 1024 × 768 / 60 Hz		
BNC output	1-ch, BNC (1.0 Vp-p, 75 Ω), Resolution: PAL: 704 × 576; NTSC: 704 × 480		
Recording resolution	8MP/6MP/5MP/4MP/3MP/1080p/UXGA/720p/ VGA/4CIF/DCIF/2CIF/CIF/QCIF		
Playback resolution	8MP/6MP/5MP/4MP/3MP/1080p/UXGA/720p/ VGA/4CIF/DCIF/2CIF/CIF/QCIF		
Frame rate	25 fps (PAL) / 30 fps (NTSC)		
Audio output	1-ch, RCA ( 2.0 Vp-p, 1 kΩ )		
Dual-stream	Support   ((Sub-stream at CIF/QCIF/QXVGA/QVGA: 25 fps (PAL) / 30 fps (NTSC))		
Stream type	Video, Video & Audio		
Synchronous playback	8-ch	16-ch	16-ch
<b>Hard disk</b>			
SATA	4 SATA interfaces for 4HDDs		
e-SATA	1 e-SATA interface		
Capacity per HDD	6TB		



	TVN 2208(S)	TVN 2216(S)	TVN 2232
<b>External interface</b>			
Network interface (TVN 22)	2 RJ45 10M/100M/1000M self-adaptive Ethernet interface		
Network interface (TVN 22S only)	1 RJ45 10M/100M/1000M self-adaptive Ethernet interface		
Serial interface	1 RS-485 (Half-duplex), 1 standard RS-232		
PoE camera interface (TVN 22S only)	8 RJ45 10M/100M	16 RJ45 10M/100M	
PoE budget (TVN 22S only)	Self-adaptive network interfaces		
USB interface	Front panel: 2 USB2.0; Back panel:1 USB3.0		
Alarm in ports	16		
Alarm out ports	4		
<b>Miscellaneous</b>			
Power supply	100 to 240 VAC, 50 to 60 Hz		
Power consumption (without HDD)	≤20 W TVN 22S only: ≤20 W (without enabling PoE)		
Operating temperature	-10 to +55 °C (14 to 131 °F)		
Relative humidity	10 to 90%		
Chassis	19-inch rack-mounted 1.5 U chassis		
Dimensions (W x D x H)	445 x 390 x 70 mm (17.5' x 15.3' x 2.8 in.)		
Weight (without HDD)	≤ 5 kg (11 lb.)		

	TVN 2216P	TVN 2232P	TVN 2264P (EMEA only)
<b>Video &amp; audio input</b>			
Video compression	H.265/H.264/MPEG4		
Audio compression	G711, G722		
IP video input	16-ch	32-ch	64-ch
Audio input	1-ch, RCA ( 2.0 Vp-p, 1 kΩ )		
Bi-directional audio	Using the audio input		
Total bandwidth available (I/O)	256Mbps/256Mbps	320Mbps/256Mbps	320Mbps/256Mbps

<b>Video &amp; audio output</b>			
HDMI output	HDMI 1, 3840 × 2160/60Hz, 3840 × 2160/30Hz, 2560*1440/60Hz, 1920 × 1080/60Hz , 1600*1200/60Hz, 1280*1024/60Hz , 1280*720/60Hz , 1024*768/60Hz HDMI 2, 1920 × 1080P / 60 Hz, 1280 × 1024 / 60 Hz, 1280 × 720 / 60 Hz, 1024 × 768 / 60 Hz		

	TVN 2216P	TVN 2232P	TVN 2264P (EMEA only)
VGA output	VGA1: 2560*1440/60Hz, 1920 × 1080/60Hz , 1600*1200/60Hz, 1280*1024/60Hz , 1280*720/60Hz , 1024*768/60Hz VGA2: 1920 × 1080P / 60 Hz, 1280 × 1024 / 60 Hz, 1280 × 720 / 60 Hz, 1024 × 768 / 60 Hz		
BNC output	1-ch, BNC (1.0 Vp-p, 75 Ω), Resolution: PAL: 704 × 576; NTSC: 704 × 480		
Recording resolution	8MP/6MP/5MP/4MP/3MP/1080p/UXGA/720p/ VGA/4CIF/DCIF/2CIF/CIF/QCIF		
Playback resolution	8MP/6MP/5MP/4MP/3MP/1080p/UXGA/720p/ VGA/4CIF/DCIF/2CIF/CIF/QCIF		
Frame rate	25 fps (PAL) / 30 fps (NTSC)		
Audio output	2-ch, RCA ( 2.0 Vp-p, 1 kΩ )		
Dual-stream	Support   ((Sub-stream at CIF/QCIF/QXVGA/QVGA: 25 fps (PAL) / 30 fps (NTSC))		
Stream type	Video, Video & Audio		
Synchronous playback	16-ch	16-ch	16-ch
<b>Hard disk</b>			
SATA	8 SATA interfaces		
e-SATA	1 e-SATA interface		
Capacity per HDD	6TB		
<b>External interface</b>			
Network interface	2 RJ45 10M/100M/1000M self-adaptive Ethernet interface		
Serial interface	RS-232, RS-485, Keyboard		
USB interface	Front panel: 2 x USB 2.0; Rear panel: 1 x USB3.0		
Alarm in ports	16		
Alarm out ports	4		
<b>Miscellaneous</b>			
Power supply	100 to 240 VAC , 50 to 60 Hz		
Power consumption (without HDD)	≤30 W		
Operating temperature	-10 to +55 °C (14 to 131 °F)		
Relative humidity	10 to 90%		
Chassis	19-inch rack-mounted 2U chassis		
Dimensions (W x D x H)	445 x 470 x 90 mm(17.5 x 18.5 x 3.5 in.)		
Weight (without HDD)	≤10Kg ( 22 lb. )		

# Appendix B

## Port forwarding information

A router is a device that lets you share your internet connection between multiple computers. Most routers will not allow incoming traffic to the device unless you have configured them to forward the necessary ports to that device. By default our software and recorders require the following ports to be forwarded:

**Note:** Port forwarding may reduce the security of the computers on your network. Please contact your network administrator or a qualified network technician for further information.

Port: 80	HTTP protocol	Used to connect via IE browser.
Port: 8000	Client Software Port	Used to connect to video streams.
Port: 554	RTSP Port	Real time streaming protocol. Used to record video remotely.
Port: 1024	RTSP Port for 3G/4G	Use with mobile apps. Used for 3G/4G connection.

**Note:** It is recommended that the RTSP port 1024 should only be used when experiencing connection issues over a 3G/4G connection.

## Seeking further assistance

Third-party assistance on configuring popular routers can be found at:

<http://www.portforward.com/>

<http://canyouseeme.org/>

<http://yougetsignal.com>

**Note:** These links are not affiliated with nor supported by Interlogix technical support.

Many router manufacturers also offer guides on their websites as well as including documentation with the product.

On most routers the brand and model number is located on or near the serial number sticker on the bottom of the device.

If you cannot find any information for your particular router, please contact your router manufacturer or internet service provider for further assistance.

# Appendix C

## Maximum pre-recording times

The maximum pre-recording time that can be selected depends on the bit rate. Frame rate, resolution and image quality do not impact time.

**Note:** This information only applies when the bit rate is set to Constant (see “Initializing the recording settings” on page 58 for more information).

Constant bit rate	Maximum pre-recording time (seconds)
32	30
48	30
64	30
80	30
96	30
128	30
160	30
192	30
224	30
256	30
320	30
384	30
448	30
512	30
640	30
768	30
896	30
1024	30
1280	25

<b>Constant bit rate</b>	<b>Maximum pre-recording time (seconds)</b>
1536	20
1792	15
2048	15
3072	10
4096	5

# Appendix D

## Default menu settings

<b>Display Settings</b>	
Display	
General	
	BNC Output Standard
	Picture Setting: Standard
	BNC output Brightness
	VGA Resolution: (Null)
	HDMI Resolution:
	Display Status Icons: Yes
	Time Bar Transparent: Yes
	Enable Time Bar: Yes
	TimeBar Size: Large
	Video Output Interface: HDMI
	Default View: 2*2 (for 4-ch models), 3*3 (for 8-ch models), and 4*4 (16-ch models)
	Sequence Dwell Time: No switch
	Enable Audio Output: No
	Volume: (Null)
	Event Monitor: HDMI
	Event Full-Screen Monitoring Dwell Time (s): 10
	Alarm Full-Screen Monitoring Dwell Time (s): 10
Layout	
	Video Output Interface: HDMI
<b>Camera Setup</b>	
IP Camera Status	
IP Camera	
	Camera No., Status, PoE Port, Edit, Advanced Set, Live View, Camera Name, IP Camera Address, Manage Port, Protocol, Device Model, Serial Number,

		and Firmware
		IP Camera Import/Export
PoE Setup		
		Auto PoE
Camera Recording Settings		
		Record
		Camera Name: (Null)
		Record Stream Mode: Main Stream (TL-Hi)
		Stream Type: Video
		Resolution: 960*576 (960H)
		Bit Rate: Variable
		Video Quality: Highest
		Frame Rate: 12 fps
		Max. Bitrate Mode: General
		Max Bitrate (Kbps): 4096
		Pre Event: 5 s
		Post Event: 5 s
		Auto Delete (day): 0
		Record Audio: No
Snapshots		
		Snapshot
		Camera: IP Camera 1
		Resolution: Maximum
		Snapshot quality: Medium
Camera OSD		
		Camera OSD Settings
		Camera: IP Camera 01
		Camera Name: IP Camera 01
		Display Name: Yes
		Display Date: Yes
		Display Day: Yes
		Date Format: MM-DD-YYYY
		Time Format: 12-hour
		Display Mode: Non-transparent & Not Flashing
Image		
		Image Settings
		Camera: IP Camera 01
		Image Setting: Standard



		Brightness: 128
		Contrast: 128
		Hue: 128
		Enable Rotate: Off
		Mirror Mode: Off
Motion Detection		
	Motion Detection Settings	
		Camera: IP Camera 01
		Enable Motion Detection: No
		Enable Dynamic Analysis: Yes
		Actions: Trigger Channel [camera-self]; Arming Schedule - All day for whole week; Actions: (Null)
		Sensitivity: 4
		Zone: Full Screen
Privacy Mask		
	Privacy Mask Settings	
		Camera: IP Camera 01
		Enable Privacy Mask: No
		Clear All
		Clear Zone 1, 2, 3, 4: Null
Camera Tamper		
	Camera Tamper Settings	
		Camera: IP Camera 01
		Enable Camera Tamper: No
		Actions: Arming Schedule - All day for whole week; Actions: (Null)
		Sensitivity: 0
		Clear
VCA		
	VCA	
		Camera: IP Camera 01
		Enable VCA Alarm: No
		VCA Type: Face Detected
		Actions: Trigger Channel [camera-self]; Arming Schedule - All day for whole week; Actions: (Null)
PTZ Preset/Tours		
	Preset/Tours	
		Camera: IP Camera 01
		Save Preset

	Call Preset
	Shadow Tour 1
	Preset Tour 1
V-Stream Encoding	
	Enable V-Stream Encoding: No
	Frame Rate:
	Max. Bitrate (Kbps):
People Counting	
	Camera: IP Camera 01
	Report Type: Daily Report
	Statistics Time: [Day]
<b>Networking Settings</b>	
Network Settings	
	Network Settings
	NIC Type: 10/100M/1000M Self-adaptive
	Internal NIC Ipv4 Address (TVN 22S only): 192.168.254.1
	Enable DHCP: No
	IPv4 address: 192.168.1.82
	IPv4 Subnet Mask: 255.255.255.0
	IPv4 Default Gateway: 192.168.1.1
	Mac Address: (It depends)
	Preferred DNS Server: (Null)
	Server Port: 8000
	Multicast IP: (Null)
	Outgoing Bandwidth Limit (Kbps): 81920
	IPv6 Address1: (Null)
	IPv6 Address2: (Null)
	IPv6 Address Gateway: (Null)
	MTU: 1500
	Alternate DNS Server: (Null)
	HTTP Port: 80
	RTSP Server Port: 554
PPPoE	
	PPPoE
	Enable PPPOE: (Null)
	User Name: (Null)
	Password: (Null)

		Confirm: (Null)
DDNS		
DDNS		
		Enable DDNS: No
		DDNS Type: ezDDNS
		Server Address: www.tvr-ddns.net
		Host Name: (Null)
NTP		
NTP		
		Enable NTP: No
		Interval (min): 60
		NTP Server: time.nist.gov
		NTP Port:123
Email		
Email		
		Enable Server Authentication: No
		User Name: (Null)
		Password: (Null)
		SMTP Server: (Null)
		SMTP Port: 25
		Enable SSL: No
		Sender: (Null)
		Sender's Address: (Null)
		Select Receiver: Receiver 1
		Receiver: (Null)
		Receiver's Address: (Null)
		Include Snapshot: No
		Interval: 2 s
FTP		
FTP		
		Enable FTP: No
		FTP Server: (Null)
		FTP Port: 21
		User Name: (Null)
		Password: (Null)
		Directory: Use root directory
		Parent Directory: (Null)
		Secondary Directory: (Null)

SNMP	
SNMP	Enable SMNP: No SNMP Version: SNMP Port: 161 Read Community: Public Write Community: Private Trap Address: (Null) Trap Port: 162
UPnP	
UPnP	Enable UPnP: No Mapped Type: Auto Port Type: HTTP Port; RTSP Port ; Server Port; HTTPS Port
Net Detect	
Traffic	Network Delay, Packet Loss Test: Select NIC, Destination Address Network Packet Archive: Device Name LAN1: 192.168.1.82
Network Statistics	
Network Stat.	Type: Bandwidth IP Camera: Remote Live View: 0bps Remote Playback: 0bps Net Receive Idle: Net Send Idle:
<b>Recording</b>	
Recording Schedule	
Recording	Camera: IP Camera 01 Enable Recording: Yes Schedule: All day for whole week TL-Hi
General	
General	Instant Playback Duration: 5 minutes

Manual Recording	
Manual Recording	Off
Hot Spare	
General	Work Mode: Normal Mode
	Enable Recovery Mode: No
	Recovery Mode Address: (Null)
	Recovery Mode Password: (Null)
	Working Status: (Null)
<b>Alarm &amp; Event Setup</b>	
Alarm Input	
Alarm Input	Alarm Input No.: A<-1
	Alarm Input Name: (Null)
	Type: NO
	Enable Alarm Input: No
	Actions: Trigger channel - No; Alarm schedule - All day for whole week; Rule (Null); PTZ link: (Null)
Alarm Output	
Alarm Output	Alarm Output No.: A->1
	Alarm Output Name: (Null)
	Time Out: 5 s
	Actions: All day for whole week
Manual Trigger	
Manual Alarm	Trigger: None
Alarm Audio	
Alarm Audio	Audio 1; File Name; Size
	Audio 2; File Name; Size
	Audio 3; File Name; Size
	Audio 4; File Name; Size
	Audio 5; File Name; Size
Notifications	
Notification	Display Event Icon: Yes

Event Hint Settings: (Null)	
Event Priority: VCA< Motion	
Notification Type: HDD Full	
Enable Alarm Audio: No	
Notify Alarm Host: No	
Send Email: No	
Trigger Alarm Output: No	
Video Loss	
Video Loss Settings	
Camera: IP Camera 01	
Enable Video Loss Alarm: No	
Actions: Arming Schedule - All day for whole week; Rule (Null);	
Alarm Host Setup	
Alarm Host Setup	
Alarm Host 1 IP: (Null)	
Alarm Host 1 Port: 5001	
Alarm Host 2 IP: (Null)	
Alarm Host 2 Port: 5001	
Alarm Host 3 IP: (Null)	
Alarm Host 3 Port: 5001	
Intrusion Panel Setup	
Intrusion Panel Setup	
Enable Intrusion Panel Connection: No	
Select Intrusion panel: 1	
Name Intrusion Panel: Panel 1	
Number of Zones: 32	
IP Address Intrusion Panel: (Null)	
Server Port: (Null)	
Enable Panel Heartbeat Alarm: No	
Heart Beat Interval(s): 30	
Actions: Arming Schedule; Actions; PTZ Linking	
Enable Panel Arming Alarm: No	
Actions: Arming Schedule; Actions; PTZ Linking	
Enable Panel Disarming Alarm: No	
Actions: Arming Schedule; Actions; PTZ Linking	
Intrusion Zone Setup	
Intrusion Zone Setup	

	Select Intrusion Panel: 1
	ID: 1
	Zone Number: 1
	Actions: Trigger Channel, Arming Schedule; Actions; PTZ Linking
<b>Device Management</b>	
Time & Date Settings	
DST Settings	
	Time Zone: (GMT-08:00) Pacific Time (U.S. & Canada)
	Date Format: MM-DD-YYYY
	Time Format: 12-hour
	Display Day: No
	System Date: Current System Date
	System Time: Current System Time
	Auto DST Adjustment: No
	Enable DST: No
	From: Apr 1st Sun 2:00
	To: Oct last Sun 2:00
	DST Bias: 60 minutes
General Settings	
General	
	Language: English
	Device Name: TVN 22
	Remoter Control ID: 255
	Keypad Zone ID: 1
	Menu Timeout: 5 Minutes
	Output Mode: Auto
	Mouse Pointer Speed: Low
	Enable Wizard: Yes
	Start Wizard Now: No
	Password Required : Yes
	Enable Front Panel Lock: No
Configuration Files	
Import/Export Config Files	
	Device Name: (Null)
Upgrade Firmware:	
Local Upgrade	
	Source: USB

Device Name: (Null)	
Holiday	
Holiday Settings	
Status: All Disabled; Start Date: 1st. Jan; End Date: 1st Jan	
RS-232 Settings	
RS-232 Settings	
Baud Rate: (Null)	
Data Bit: 8	
Stop Bit: 1	
Parity: None	
Flow Ctrl: None	
Interface: Technical Support	
<b>Storage Management</b>	
HDD Information	
Label: No	
Total Capacity:	
Free Space:	
Overwrite: Yes	
eSATA: eSATA1	
Usage: Record/Capture	
Storage Mode	
Storage Mode	
Mode: Quota	
Camera: IP Camera 01	
Used Record Capacity: (Null)	
Used Snapshot Capacity: 0 MB	
HDD Capacity (GB): (Null)	
Max. Record Capacity (GB): 0	
Max. Snapshot Capacity (GB): 0	
S.M.A.R.T Settings	
S.M.A.R.T. Settings	
Use when the disk has failed to self-evaluate: No	
HDD No.: 1	
Self-test Status: Not Tested	
Self-test Type: Short Test	
S.M.A.R.T.:	
Temperature (°C):	



		Power Up (days):
		Self-evaluation: Pass
		All-evaluation: Functional
		S.M.A.R.T. Information : ID ; Attribute Name ; Status ; Flags ; Threshold ; Value ; Worst ; Raw Value
<b>Bad Sector Detection</b>		
	Bad Sector Detection	
		HDD No.: (Null)
		Key Area Detection: Detect
		HDD Capacity: (Null)
		Block Capacity: (Null)
		Status: (Null)
		Error Count: (Null)
<b>RAID</b>		
	Physical HDD	
		Enable RAID: Enable
		No.:
		Capacity:
		Array:
		Type:
		Status:
		Model:
		Hot Spare:
<b>User Management</b>		
	Users	
	User Management	
		Enable Complex Passwords: No
		operator: 4321
		guest: (Null)
<b>System Information</b>		
	Device Info	
	Device Info	
		Device Name
		Model: (Model number)
		Serial No.: (Model's serial number)
		Firmware Version:
		Encoding Version:

Camera	
Camera	Camera No.; Camera Name; Status; Motion Detection; Camera Tamper, Video Loss; Preview Link Sum; Preview Link Info
Record	
Record	Camera No.; Recording Status; Stream Type; Frame Rate; Bitrate (Kbps); Resolution; Record Type; Active Schedule
Alarm Inputs	
Alarm Inputs	No.; Alarm Name; Alarm Type; Alarm Status; Triggered Camera
Alarm Outputs	
Alarm Outputs	No.; Alarm Name; Alarm Status
Network	
Network	NIC: LAN1
	IPv4 Address:
	IPv4 Subnet Mask:
	IPv4 Default Gateway:
	IPv6 Address 1:
	IPv6 Address 2:
	IPv6 Default Gateway:
	MAC Address:
	Preferred DNS Server:
	Alternate DNS Server:
	Enable DHCP:
	Enable PPPOE:
	PPPOE Address:
	PPPOE Subnet Mask:
	PPPOE Default Gateway:
	Server Port: 8000
	HTTP Port: 80
	Multicast IP:
	RTSP Service Port:
	Outgoing Bandwidth Limit (Kbps):

HDD	
	HDD
	Label; Status; Capacity; Free Space; Property; Type; Group
Log search	
	Log search
	Start Time:
	End Time:
	Event: All
	Type: All

# Index

## A

- Alarm audio
  - import files, 94
- Alarm center
  - event notifications, 95
- Alarm inputs
  - playback, 91
  - set up, 91
- Alarm notifications
  - response actions, 92
  - video loss, 97
  - video tampering, 66
- Alarm outputs
  - manually acknowledge, 94
  - set up, 93
- Archive
  - export files to a backup device, 49
  - locked files, 46
  - quick archive, 47
  - snapshots, 46
  - video clips, 46, 50
  - window description, 48

## B

- Back panel description, 4
- Bad sector detection, 117
- Bookmarks
  - create, 45
  - delete, 45
  - playback, 45
  - rename, 45
  - saving, 45
  - types, 45

## C

- Cameras
  - layout, 54
  - pre and post event times, 60
  - privacy mask, 65
  - recording settings, 60

## D

- Daily schedules

- record, 86
- Date
  - configure display, 105
- DDNS settings, 77
- Default settings
  - restore, 108
- Digital zoom
  - description, 25
  - playback, 35
- DST (daylight saving time), 105

## E

- EFR (edge failover recording), 89
- Email notifications
  - set up, 79
- eSATA, 116
- Event logs
  - search remotely, 141
- Event notifications
  - types, 95
- Export configuration settings, 108
- Export files to a backup device, 49

## F

- Factory default settings
  - restore, 108
- Failover, 88
- Firmware
  - update, 109
- Frame-by-frame playback, 44
- Front panel
  - button functions by task, 13
- Front panel description, 11
- Front panel lock, 108
- FTP server settings, 80

## H

- HDD
  - add, 113
  - checking status, 112
  - dual streaming mode, 114
  - grouping, 115
  - initialize, 113
  - overwrite, 114
  - properties, 115

- quota mode, 114
- sleep mode, 116
- storage mode, 114
- Holiday schedules
  - recording, 109, 110
- Hot spare, 88

## I

- Import configuration settings, 108
- Instant playback, 37
- Intrusion panel setup, 99
- IP camera
  - automatically add, 56
  - manually add, 56
  - status, 56
  - supported, 56

## L

- Language
  - change GUI language, 107
- Live mode
  - configure time and date display, 105
- Live view
  - digital zoom, 25
  - pop-up menu, 22
  - status icons, 21
- Live view toolbar, 24
- Lock/unlock recorded files, 45
- Login password, 107

## M

- Main menu
  - accessing, 18
  - description, 18
  - icon descriptions, 18
- Manual recording, 87
- Menu timeout
  - change time, 107
- Monitors
  - change output mode, 107
  - connect, 6
- Motion detection
  - playback, 39
  - set up, 64
  - smart playback, 40
- Mouse pointer speed
  - change, 107

## N

- NAS, 110
- Network packet data
  - export, 82
- Network settings
  - general set up, 74
- Network settings for browser, 133
- Network status, 81

- Network storage system
  - set up, 110
- Network traffic
  - check, 81
- NTP server, 78

## O

- Object counting, 72
- OH alarm reporting
  - setup, 99
- Osborne Hoffman alarm reporting, 99
- OSD settings, 62

## P

- Password
  - change admin password, 125
  - change user password, 124
  - complex format, 121
  - enable/disable login password, 107
- People counting, 72
- Playback
  - 24-hour playback, 38
  - alarm inputs, 39
  - bookmarks, 38, 45
  - digital zoom, 44
  - events, 39
  - external files, 38
  - instant playback, 37
  - instant playback duration, 87
  - motion and VCA events, 40
  - motion detection, 39
  - play back archived files, 50
  - playback speed, 44
  - search by event, 31
  - search by time, 30
  - search by video type, 30
  - search results, 30
  - skip time, 43
  - smart events, 40
  - snapshots, 32, 38
  - split-screen, 42
  - sub-periods, 42
  - use the web browser, 140
- Playback control panel
  - description, 35
- Player
  - use for playback, 50
- PoE
  - automatically allocate power, 60
  - power consumption, 58
- PPPoE settings, 76
- Preset tours
  - call up, 28
  - quick access, 27
  - set up, 70
- Presets
  - call up, 70
  - quick access, 27

- select, set up and delete, 68
- set up, 70
- Privacy mask, 65
- Protect recorded files, 45
- PTZ control panel
  - description, 27
- PTZ dome cameras
  - control remotely, 139

**Q**

- QR code, 126

**R**

- RAID array
  - create, 118
  - rebuild, 118
  - verify, 118
- Recorder address
  - change, 107
- Recorder name
  - change, 107
- Recording
  - audio setup, 60
  - auto delete, 60
  - bitrate setup, 60
  - browser, 142
  - frame rate, 60
  - pre/post event times, 60
  - recording schedules, 84
- Recording schedules
  - daily, 86, 109, 110
  - define, 84
- Remote alarm host settings, 98
- Remote control
  - connect to the recorder, 17
  - description, 15
- Resolution
  - change monitor resolution setup, 107
- RTSP service port, 58

**S**

- S.M.A.R.T. information on a HDD, 116
- SAN, 110
- SD card
  - EFR, 89
  - set up recording, 89
- Search
  - bookmarks, 45
  - recordings by event, 31
  - snapshots, 32
  - system logs, 129
- Sequencing cameras, 24
- Setup wizard
  - using, 8
- Shadow tours
  - set up, 71
- Skip time

- playback, 43
- Smart events
  - playback, 40
- Snapshots
  - capture remotely, 140
  - playback, 32
  - recording settings, 61
  - upload to FTP server, 80
- SNMP protocol settings, 80
- Soft keyboard, 19
- Status icons
  - enable/disable display, 107
- System information
  - view, 126
- System logs
  - playback, 129
  - search, 129

**T**

- Tampering
  - detect video tampering, 66
- Time
  - configure display, 105
- Turn on and off the recorder, 7
- TVRMobile
  - push notifications, 103
  - recorder QR code, 126

**U**

- User privileges
  - camera configuration, 123
  - local configuration, 122
  - remote configuration, 123
- Users
  - add a new user, 121
  - customize user privileges, 122
  - delete a user, 124
  - modify user information, 124, 125

**V**

- VCA
  - playback, 39, 40
  - setup alarm actions, 67
  - types, 67
- Video format
  - PAL/NTSC, 7
- Video loss
  - set up detection, 97
- Video output
  - change manually, 107
- Video outputs, 22
- Video search menu, 29
- Video tampering
  - detect, 66
- V-stream encoding
  - set up, 72

**W**

## Web browser

- access, 133
- camera management, 143
- live view, 137
- remote configure the recorder, 143
- search and play back recorded video, 140
- search event logs, 141
- video snapshot, 140

## Wizard

- enable/disable, 107